

UT 9200/9100



Receiver UT 9200/9100 R



Fig. 1: Receiver

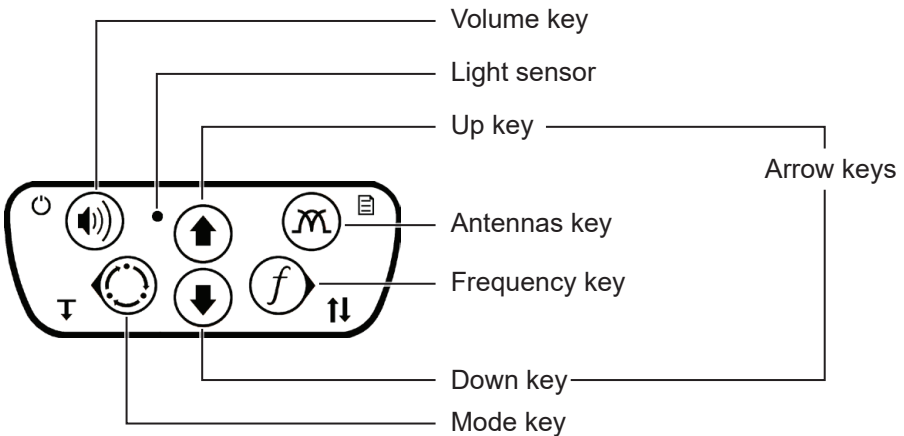

Fig. 2: Receiver control panel

Generator UT 9012/9005 TX

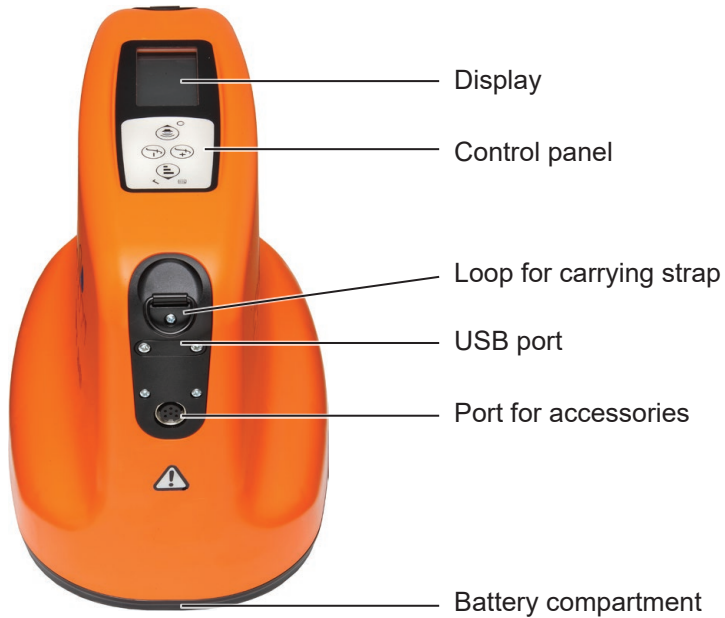

Fig. 3: Generator

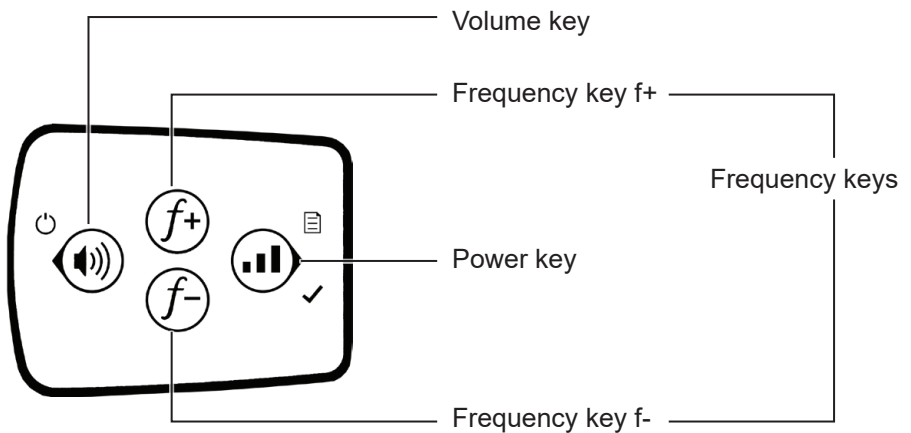

Fig. 4: Generator control panel

Illustration of warnings in this document



WARNING!

Risk of personal injury. Could result in serious injury or death.



CAUTION!

Risk of personal injury. Could result in injury or pose a risk to health.

1	Introduction	1
1.1	Information about this document.....	1
1.2	Purpose.....	2
1.3	Intended use	2
1.4	Safety information	2
1.5	Safety information for lithium-ion rechargeable battery.....	4
2	System overview	5
2.1	General information.....	5
2.2	System components.....	5
3	Receiver UT 9200/9100 R.....	8
3.1	General information.....	8
3.2	Location modes and antennas	8
3.3	Control panel.....	10
3.4	Measuring mode and menu	13
3.4.1	Display in measuring mode.....	13
3.4.1.1	Approaching a location object (compass)	14
3.4.1.2	Field strength display	16
3.4.1.3	Gain display	16
3.4.1.4	Depth display	17
3.4.1.5	Toolbar	18
3.4.2	Display with main menu	18
3.4.3	Navigating the menus	19
3.5	Satellite connection	20
3.6	Power supply.....	20
4	Receiver menus.....	22
4.1	Main menu (overview).....	22
4.2	Configuration menu.....	22
4.2.1	Frequencies	22
4.2.2	Modes	22
4.2.3	Antennas	23
4.2.4	Settings	23
4.2.4.1	Language	23
4.2.4.2	Units	24
4.2.4.3	Backlight.....	24
4.2.4.4	Shutdown Timer	24
4.2.4.5	Communications	24

4.2.5	Options.....	26
4.2.5.1	Audio.....	27
4.2.5.2	Gain.....	27
4.2.5.3	L/R Arrows.....	28
4.2.5.4	Autodepth.....	29
4.2.5.5	Offset Depth.....	29
4.2.5.6	User Interface.....	30
4.3	Utility Type menu.....	30
4.4	Metrics menu.....	30
4.5	System Info menu	31
4.6	Ambient Noise menu	31
4.7	TX Control menu	31
5	Generator UT 9012/9005 TX.....	32
5.1	General information.....	32
5.2	Operating modes.....	32
5.3	Control panel.....	33
5.4	Transmitting mode and menu.....	34
5.4.1	Display in transmitting mode	34
5.4.2	Display with main menu	36
5.4.3	Navigating the menus	36
5.5	Power supply.....	37
5.5.1	Powered by batteries	38
5.5.2	Powered by lithium-ion rechargeable battery.....	39
6	Generator menus	40
6.1	Main menu (overview).....	40
6.2	Frequencies menu	40
6.3	Settings menu	40
6.3.1	Backlight.....	40
6.3.2	Output	41
6.3.3	Meter	43
6.3.4	Communications	44
6.4	Options menu.....	45
6.4.1	Language	45
6.4.2	Shutdown Timer	45
6.4.3	Fault Mode	46
6.5	System Info menu	46

7	Using the system	47
7.1	Establishing a radio connection between devices.....	47
7.1.1	Linking the receiver and generator.....	47
7.1.2	Unlinking the receiver and generator	48
7.2	Adjusting the volume or switching off the sound	48
7.3	Setting the frequency	49
7.3.1	Enabling frequencies.....	50
7.3.2	Selecting a frequency.....	50
7.4	Adjusting the gain.....	51
7.5	Controlling the generator with the receiver (TX Control).....	52
7.6	Ambient noise detection.....	53
7.7	Determining the depth.....	54
7.7.1	Determining the depth automatically.....	55
7.7.2	Determining the depth manually	55
7.7.3	Determining the offset depth	56
7.8	Evaluating saved locating results externally	57
7.8.1	Saving a measurement	58
7.8.2	Connecting the receiver to a Bluetooth-enabled device.....	58
7.8.3	Unpairing the receiver and Bluetooth-enabled device	59
7.8.4	Reading out measurements	59
7.9	Configuring or updating the receiver and generator via the software.....	60
8	Active locating of lines	61
8.1	Energising a line.....	61
8.1.1	Direct energising	61
8.1.1.1	Enabling/disabling the connected cable set.....	63
8.1.1.2	Parallel connection (splitter cable)	63
8.1.2	Indirect energising.....	65
8.1.2.1	Energising without accessories on the generator	65
8.1.2.2	Energising with a cable clamp.....	66
8.2	Locating a line	67
8.3	Using direction detection.....	68
8.4	Energising with a high power	70
9	Active locating of beacons.....	72
10	Passive locating	75

11	Locating with special accessories	77
11.1	Step-voltage probe (locating cable faults).....	77
11.1.1	Approaching a cable fault.....	78
11.1.2	Locating cable faults	79
11.2	Marker ball antenna (locating a marker)	80
11.2.1	General information.....	81
11.2.2	Connecting the receiver and marker ball antenna	83
11.2.3	Locating marker with known frequency.....	84
11.2.4	Locating unknown marker	85
11.2.5	Disconnecting the receiver and marker ball antenna	85
11.3	Receiver clamp (locating cable bundle)	86
11.4	Receiving antenna (locating single leads).....	87
12	Maintenance and error management	90
12.1	Lithium-ion rechargeable battery (generator).....	90
12.1.1	Storing rechargeable batteries	90
12.1.2	Charging the rechargeable battery.....	90
12.1.3	Handling faulty lithium-ion rechargeable batteries	91
12.2	Care	92
12.3	Servicing	92
12.4	Solving problems.....	93
12.4.1	Source of errors during the locating process	93
12.4.2	Problems with the receiver	94
12.4.3	Problems with the generator	95
13	Appendix.....	96
13.1	Technical data	96
13.1.1	Receiver UT 9200/9100 R.....	96
13.1.2	Generator UT 9012/9005 TX.....	97
13.2	Preset frequencies (factory settings).....	100
13.2.1	Receiver UT 9200/9100 R.....	100
13.2.2	Generator UT 9012/9005 TX.....	101
13.3	Symbols (meaning)	102
13.4	Connecting or linking devices? Difference between radio and Bluetooth connection.....	106
13.5	Accessories and consumables.....	106
13.6	Declaration of conformity	107
13.7	FCC Compliance Statements.....	107
13.8	Advice on disposal	108
14	Index.....	109

1 Introduction

1.1 Information about this document

This document is a component part of the product.

- Read the document before putting the product into operation.
- Keep the document within easy reach.
- Pass this document on to any subsequent owners.
- Unless otherwise specified, the information in this document refers to the product as delivered (factory settings) and applies to all product variants.
- Contradictory national legal regulations take precedence over the information in this document.

Note:

These operating instructions describe systems **UT 9200** and **UT 9100**.

The included components only differ slightly with regard to functionality and some performance features. All of the functions are described in the operating instructions even if they are not available for individual product variants. Information about the differences between the product variants is available in section 3.1 and section 5.1.

The descriptions refer to the system as delivered (factory settings).

Translations

Translations are produced to the best of our knowledge. The original German version is authoritative.

Right of reproduction

No part of this document may be edited, duplicated or circulated in any form without the express consent of Hermann Sewerin GmbH.

Registered trademarks

Registered trademarks are generally not indicated in this document.

1.2 Purpose

UT 9200/9100 is an electronic locating system to detect electrically conductive, underground lines.

The system can be used for:

- Locating and tracking lines
Lines refer to current-conducting and signal-transmitting cables as well as supply lines, for example.
- Determining the depth of lines

1.3 Intended use

The product is suitable for the following uses:

- Professional
- Industrial
- Commercial

The product must only be used for the applications specified in section 1.2.

Note:

Specialist knowledge is required to operate the system. Work on electrical installations may only be completed by trained specialists.

1.4 Safety information

This product was manufactured in accordance with all binding legal and safety regulations.

The product is safe to operate when used in accordance with the instructions provided. However, when handling the product, there may be risks to persons and property. For this reason, observe the following safety information without fail.

- Observe all the applicable safety standards and accident prevention regulations. This particularly applies to work on electrical systems (e.g. current-carrying cables).
- Use the product only as intended.
- Handle the product carefully and safely, both during transport and when working.
- Do not make any changes or modifications to the product unless these have been expressly approved by Hermann Sewerin GmbH.
- Do not use the product if it is damaged or faulty. Never use damaged or defective accessories.
- Only use accessories and consumables approved by Hermann Sewerin GmbH.

If not described otherwise: Standard batteries or rechargeable batteries can be used for the power supply of the products.

- At the same time, always use power sources that are identical in terms of type (battery or rechargeable battery), capacity, manufacturer, charge and state (new or used).
- Always observe the permitted operating and storage temperatures.
- Before starting the location work obtain information about the route of buried cables and lines from local utility companies.
- Always adequately cordon off the work area.
- Never operate the product in the vicinity of explosive areas.
- Protect the ports and sockets on the product against dirt, and electrical ports in particular against moisture.
- Do not submerge the product in liquids.
- When you are wearing headphones, you are not fully aware of ambient noise. Be especially vigilant, especially in environments with an increased risk of accident (e.g. traffic).
- Only set the volume as high as absolutely necessary. Excessive noise can cause permanent damage to your hearing.

1.5 Safety information for lithium-ion rechargeable battery

- Risk of short circuit! Do not touch the power connector poles with metal.
- Never try to open the rechargeable battery.
- Do not use the rechargeable battery if it is damaged.
- Prevent the ingress of moisture into the rechargeable battery.
- Protect the rechargeable battery from mechanical loads (impact, vibration). Never drop the rechargeable battery.
- Observe the permissible conditions during charging, storage and operation. Protect the rechargeable battery against very low and high temperatures even when these are in the permissible range.
- Only charge the rechargeable battery using the relevant AC/DC adapter.
- Never place the rechargeable battery on an open fire.
- Dispose of the rechargeable battery in accordance with applicable guidelines.

2 System overview

2.1 General information

System **UT 9200/9100** can be used for active and passive locating. During active locating the required electromagnetic field is generated with a generator. During passive locating existing electromagnetic fields are used.

SEWERIN recommends: Always check the plausibility of the system's location results.

2.2 System components

The system has a modular construction. The main system components are as follows:

	UT 9200 system	UT 9100 system
Receiver	UT 9200 R	UT 9100 R
Generator	UT 9012 TX or UT 9005 TX	
Software	UT configurator	
App	UT 9200 Com	–

The receiver and generator can be transported and stored in bags.

Information about the receiver can be found in section 3 and the generator in section 5.

Accessories

Accessories can be added to the system at any time, for example:

- active locating of lines
 - double cable set (splitter cable) or simple
 - earthing spike
 - cable clamp
- active locating of beacons
 - beacon (locating transmitter)
 - fibre glass rod

- special locating tasks (only **UT 9200 R**)
 - step-voltage probe
 - marker ball antenna
 - receiver clamp
 - receiving antenna

UT configurator software

The **UT configurator** software can be used to update and efficiently configure the receiver and generator.

The software can be used to execute the following tasks, for example:

- update firmware
- preset, activate frequencies
- create own frequencies (in addition to available ones)
- configure the device (receiver, generator)
- set up the start screen (e.g. company logo as background)
- save individual settings and load again at a different point in time

Prerequisites for using the software:

- software is installed on a computer
- device is connected to the computer via a USB cable

The software can be downloaded free of charge from www.sewerin.com.

Information on updates and configurations is provided in section 7.9.

UT 9200 Com app

Note:

The app is only available for receiver **UT 9200 R**.

The **UT 9200 Com** app is designed for the subsequent evaluation of saved measurements.

The app can be used to execute the following tasks, for example:

- read out receiver measurements
- view measurements in the app's map view
- transfer data, for example, by e-mail to another device so that the measurements can be saved there

Prerequisites for using the app:

- app is installed on a Bluetooth-enabled device
- receiver and Bluetooth-enabled device are connected

The **UT 9200 Com** app is available free of charge for Android and iOS.

3 Receiver UT 9200/9100 R

3.1 General information

The receiver can detect signals from electromagnetic fields. Signals are reproduced:

- visually on the display
- audibly via the loudspeaker or headphones

The field strength is shown graphically and numerically on the display. The direction arrows and other graphical elements help when approaching the location object just like the audible sound and special signal tones.

The volume set for the loudspeaker or headphones does not affect the sensitivity of the receiver, i.e. loud signals are not necessarily strong signals.















You will find an overview of the receiver parts inside the front cover (fig. 1).

Product variants



Receiver	UT 9200 R	UT 9100 R
for system	UT 9200	UT 9100
Differences	<ul style="list-style-type: none">• GNSS module for position determination• measuring data memory• Bluetooth for external GNSS• app to evaluate saved measurements• accessories for special locating tasks available	–



3.2 Location modes and antennas

Different location modes can be used during active and passive locating. Different antennas can be selected based on the locating mode.





Locating method	Locating mode	Antenna
active	 Line	 Twin  Single  Null
	 Autogain	 Single
	 Beacon	 Total Field
passive	 Power	 Twin  Single  Null
	 Radio	 Twin

Locating mode

Locating mode	Suitable locating objects
 Line	<ul style="list-style-type: none"> lines that are energised by a generator Features: <ul style="list-style-type: none"> – manual or semi-automatic gain control – several antennas can be used
 Autogain	<ul style="list-style-type: none"> lines that are energised by a generator Features: <ul style="list-style-type: none"> – automatic gain control – only Single antenna can be used – special audible signal
 Power	<ul style="list-style-type: none"> live cables <ul style="list-style-type: none"> – available network frequencies: <ul style="list-style-type: none"> 50 Hz, 100 Hz, 150 Hz (Europe) or 60 Hz, 120 Hz, 180 Hz (North America, amongst others)

Locating mode	Suitable locating objects
 Beacon	<ul style="list-style-type: none"> • non-metallic lines into which a beacon (locating transmitter) is inserted
 Radio	<ul style="list-style-type: none"> • metal lines <ul style="list-style-type: none"> – frequency range 11.6 – 31.4 kHz (VLF range)

Antennas

Antenna	Description
 Twin	<ul style="list-style-type: none"> • to determine the position of a line using maximum mode In comparison to a Single antenna: <ul style="list-style-type: none"> – lower range – higher degree of accuracy
 Single	<ul style="list-style-type: none"> • to determine the position of a line using maximum mode In comparison to a Twin antenna: <ul style="list-style-type: none"> – greater range – lower degree of accuracy
 Null	<ul style="list-style-type: none"> • to determine the position of a line using minimum mode (null signal) Feature: <ul style="list-style-type: none"> – significantly more distinct signal curve over the line
 Total Field	<ul style="list-style-type: none"> • for the exact location of a beacon (locating transmitter)

3.3 Control panel

You will find an overview of the control panel elements inside the front cover (fig. 2).

The light sensor is designed to automatically control the backlight.

The keys have several functions. Symbols next to the keys illustrate the additional functions.

Volume key 

On/Off



- switching on the receiver
 - press and hold the key
- switching off the receiver
 - press and hold the key

Volume



- In measuring mode:
- adjust volume or switch off sound
 - briefly press key repeatedly

Exit the menu

- In the menu:
- exit menu and switch directly to measuring mode
 - press the key
-

Mode key 

Locating mode



- In measuring mode:
- select locating mode
 - briefly press key repeatedly

Depth



- In measuring mode:
- determine depth manually
 - press the key until there is an audible signal tone

Back



- In the menu:
- switch back to the next level up
 - briefly press the key
-

Up key

Gain



In measuring mode:

- increase gain
 - in semi-automatic gain control mode: press the key
 - in manual gain control mode: press the key several times

To top

In the menu:

- move to top
 - press key repeatedly
-

Down key

Gain



In measuring mode:

- decrease gain
 - in semi-automatic gain control mode: press the key
 - in manual gain control mode: press the key several times

To bottom

In the menu:

- move to bottom
 - press key repeatedly
-

Antenna key

Antenna



In measuring mode:

- select antenna
 - briefly press key repeatedly



Menu



In measuring mode:

- open menu
 - press and hold the key
-

Frequency key

Frequency 	In measuring mode:
	<ul style="list-style-type: none">• select frequency<ul style="list-style-type: none">– briefly press key repeatedly
Direction de- tection 	In measuring mode:
	<ul style="list-style-type: none">• enable direction detection<ul style="list-style-type: none">– press the key until there is an audible signal tone
Next 	In the menu:
	<ul style="list-style-type: none">• switch to the next level down<ul style="list-style-type: none">– briefly press the key
Select	In the menu:
	<ul style="list-style-type: none">• select settings (enable/disable)<ul style="list-style-type: none">– briefly press the key

3.4 Measuring mode and menu

When switched on the receiver is automatically in measuring mode. The current measurement values are displayed in measuring mode.

You can switch from measuring mode to the main menu. The main menu has submenus in which the user can implement settings and view information.

3.4.1 Display in measuring mode

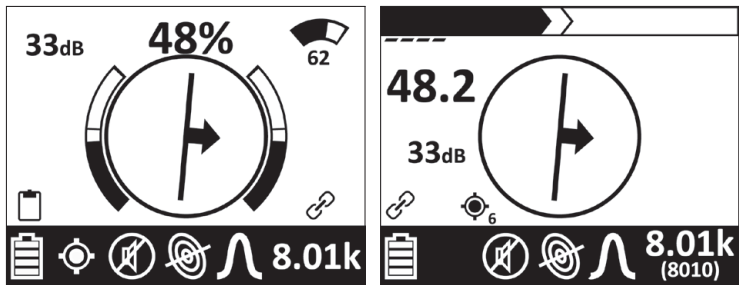

Fig. 5: Receiver display - measuring mode
Left image: **UtiliGuard2** user interface
Right image: **Classic** user interface

During the locating process graphical elements, that support the targeted approach of a location object, are shown on the display. The field strength and gain are also displayed.

If the receiver is directly above the location object the depth can be displayed.

The toolbar shows the current settings.

A schematic representation of a signal indicator is displayed in the right upper corner of the **UtiliGuard2** user interface. The signal indicator provides information about the possible range of the locating signal.

An overview of the symbols that may appear on the display can be found in section 13.3.

3.4.1.1 Approaching a location object (compass)

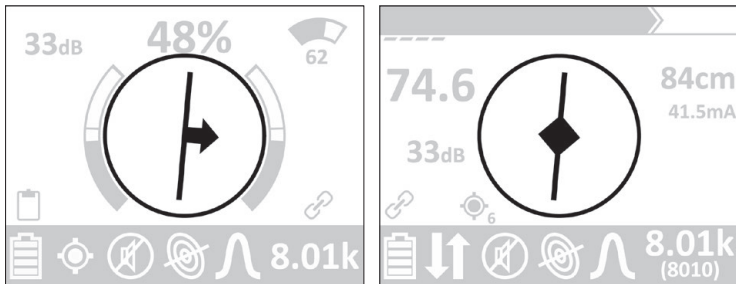

Fig. 6: Receiver display – compass

Left image: **UtiliGuard2** user interface (*here*: with directional arrow)

Right image: **Classic** user interface (*here*: with diamond)

The following graphical elements can appear when approaching a location object¹:



Compass with compass needle

- The compass needle shows the position of the line.

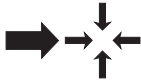

Directional arrows

- The receiver must be moved in the displayed direction.
- The shorter the arrow the smaller the distance to the location object.



Diamond

- The receiver is directly above the location object.

The following graphical elements may also be displayed when locating beacons:



Point

- The receiver is above the maximum signal curve.



Rotating arrows

- The receiver must be turned in the displayed direction.



Points

- The points indicate the position of the beacon.

¹ Does not apply to passive locating using **Radio** locating mode.

3.4.1.2 Field strength display

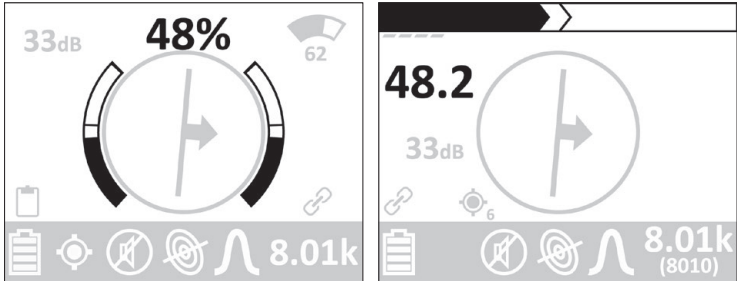

Fig. 7: Receiver display – shows the field strength (*here: 48% to 48.2*)
Left image: **UtiliGuard2** user interface
Right image: **Classic** user interface

The field strength is shown:

- numerically
- graphically

The larger the black area the higher the field strength.

A trailing pointer briefly marks the highest value of the field strength.

3.4.1.3 Gain display

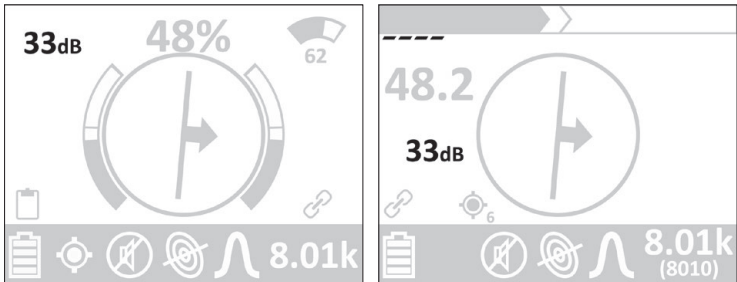

Fig. 8: Receiver display – shows the gain (*here: 33 dB*)
Left image: **UtiliGuard2** user interface
Right image: **Classic** user interface

The gain is shown:

- numerically
- graphically (**Classic** user interface only)

The more segments that are visible the greater the gain.

3.4.1.4 Depth display

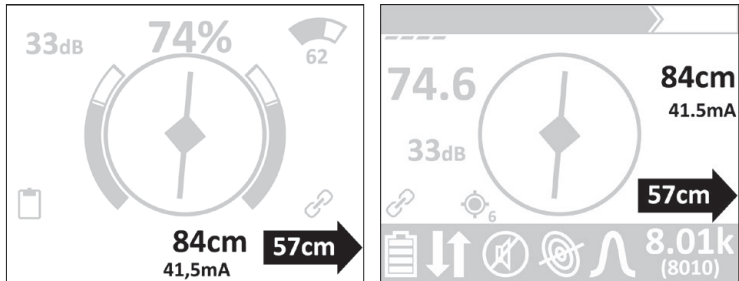

Fig. 9: Receiver display – shows the depth and offset depth (*here*: depth 84 cm, current 41.5 mA, offset depth 57 cm)

Left image: **UtiliGuard2** user interface

Right image: **Classic** user interface

The depth is shown numerically. The associated unit can be set. The current is also specified. This helps to clearly identify the energised line in the event of lines being positioned in parallel, for example.

If the **Offset Depth** function is enabled then the distance to the location object is also shown.

3.4.1.5 Toolbar

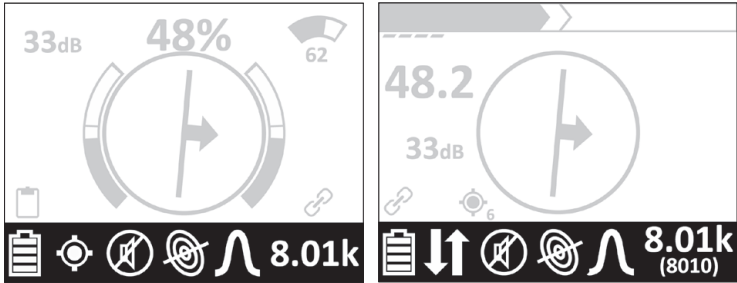

Fig. 10: Receiver display – toolbar
Left image: **UtiliGuard2** user interface
Right image: **Classic** user interface

The following is displayed in the toolbar (from left to right):

- Battery status
- Satellite connection (**UtiliGuard2** user interface)
or
Direction detection (**Classic** user interface)
- Volume
- Locating mode
- Antenna
- Frequency

3.4.2 Display with main menu

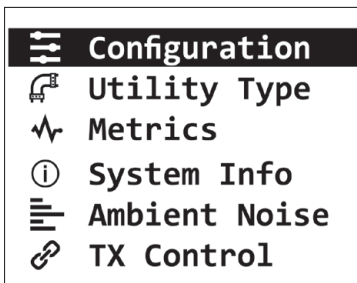

Fig. 11: Receiver display - main menu

Information about the menus can be found in section 4.

3.4.3 Navigating the menus

The control panel keys can be used to navigate the main menu and submenus.

Opening the main menu

The receiver is in measuring mode.

- Press and hold the Volume key. The main menu opens.

Selecting a menu item in a menu

The receiver shows a menu. The currently selected menu item is highlighted.

1. Use the arrow keys to select a menu item.
2. Press the Frequency key. The menu item appears.

Changing settings (enable/disable menu item)

The receiver shows a menu in which menu items can be enabled or disabled. The currently selected menu item is highlighted.

1. Use the arrow keys to select a menu item.
2. Press the Frequency key.
 - If the menu item was disabled (no checkmark set), it is enabled.
 - If the menu item was enabled (checkmark set), it is disabled.
3. Press the Volume key. The setting is applied. The receiver switches back to the next level up.

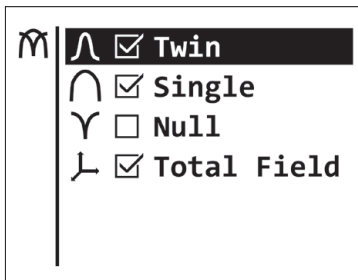

Fig. 12: Receiver display – **Antennas** menu
(*here*: menu item **NULL** disabled)

Switching back to the next level up from a menu

The receiver shows a menu or menu item.

- Press the Mode key. The receiver switches back to the next level up.

Switching directly back to measuring mode from a menu

The receiver shows a menu.

- Press the Volume key. The receiver switches directly back to measuring mode.

3.5 Satellite connection

Note:

The function is only available for receiver **UT 9200 R**.

The **UT 9200 R** receiver is equipped with a GNSS² module. The receiver can use the module to receive signals from global navigation satellites (e.g. GPS) and use them to determine the position. The function is used when saving measurements.

The search for a satellite connection or the satellite reception is shown on the display with symbols.

After switching on the receiver, the search for available satellites can take some time. SEWERIN recommends: Move the receiver to a location that is not shaded by buildings, vegetation, etc.

3.6 Power supply

The receiver is powered by batteries. Two alkaline batteries LR20, mono D are required for the power supply.

Replacing the batteries

The battery compartment lid is sealed with a quick-release fastener.

² Abbreviation for: Global Navigation Satellite System

The receiver is switched off.

1. Open the battery compartment by turning the quick-release fastener.
2. Remove the used batteries.
3. Insert the new batteries. Ensure that the polarity is correct (fig. 13).
4. Close the battery compartment.
5. Check the receiver is ready for operation.
 - To do so, switch on the receiver.

If the polarity of the batteries is not correct, you will not be able to switch on the receiver.

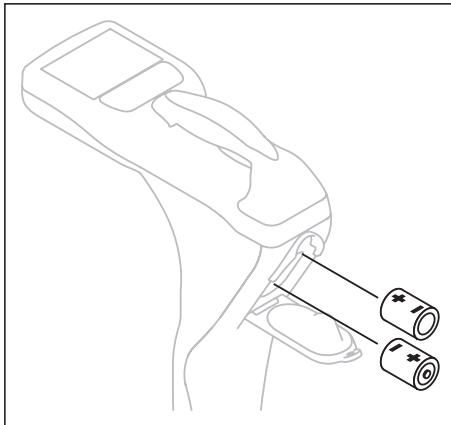

Fig. 13: Replacing the receiver batteries – polarity of the batteries

4 Receiver menus

4.1 Main menu (overview)

The main menu comprises the following menus:

- **Configuration**
- **Utility Type**
- **Metrics**
- **System Info**
- **Ambient Noise**
- **TX Control**

The main menu can be opened when the receiver is in measuring mode.

Information about navigating the menus can be found in section 3.4.3.

4.2 Configuration menu

The following can be set in the **Configuration** menu:

- **Frequencies**
- **Modes**
- **Antennas**
- **Settings**
- **Options**

4.2.1 Frequencies

The preset frequencies can be enabled and disabled in the **Frequencies** menu item. Symbols indicate for which location modes the individual frequencies are suitable.

Additional information about the frequencies can be found in section 7.3.

4.2.2 Modes

The location modes can be enabled and disabled in the **Modes** menu item. Only enabled modes can be used for the locating process.

The fewer location modes are enabled, the faster you can switch between the modes during measuring mode.

- **Line**
- **Autogain**
- **Power**
- **Beacon**
- **Radio**

Additional information about the location modes can be found in section 3.2.

4.2.3 Antennas

The antennas can be enabled and disabled in the **Antennas** menu item. Only enabled antennas can be used for the locating process.

The fewer antennas are enabled, the faster you can switch between the antennas during measuring mode.

- **Twin**
- **Single**
- **Null**
- **Total Field**

Additional information about the antennas can be found in section 3.2.

4.2.4 Settings

The following can be set in the **Settings** menu item:

- **Language**
- **Units**
- **Backlight**
- **Shutdown Timer**
- **Communications**

4.2.4.1 Language

The language of the user interface can be set in the **Language** menu item.

4.2.4.2 Units

The measuring unit for the depth and offset depth can be set in the **Units** menu item.

- **Inches**
- **Feet & Inches**
- **Meters**
- **Centimeters**

4.2.4.3 Backlight

The **Backlight** menu item can be used to set whether the display is illuminated.

- **Auto**

The display is illuminated based on the current light conditions. The light sensor on the control panel controls the activation and deactivation of the backlight.

- **Off**

The display is not illuminated.

4.2.4.4 Shutdown Timer

The **Shutdown Timer** menu item can be used to set the time after which the receiver will switch off automatically if it is not operated in the meantime.

- **5 | 10 | 15 | 20 | 30 Minutes**

The receiver switches off after the set time has elapsed.

- **Always On**

The receiver does not switch off automatically.

4.2.4.5 Communications

The interaction between the receiver, generator and external devices can be set in the **Communications** menu item.

- **Radio On/Off**
- **Bluetooth**
- **Link Info**
- **Link TX**
- **Unlink TX**

An overview of the differences between linking/connecting, unlink/unpair and Radio On/Off can be found in section 13.4.

Radio On/Off

The radio connection between the receiver and generator can be interrupted and established again in the **Radio On/Off** menu item. It may, for example, be necessary to interrupt the radio connection if you wish to establish a reliable connection to a Bluetooth-enabled device.

Note:

Interrupting the radio connection does not disable the connection between the receiver and generator.

- **On**

A radio connection is established between the receiver and generator.

- **Off**

An existing radio connection between the receiver and generator is interrupted.

Bluetooth

The connection between the receiver and Bluetooth-enabled devices can be configured in the **Bluetooth** menu item.

- **Connect**

The receiver is connected to a Bluetooth-enabled device (pairing).

- **Unpair**

The connection between the receiver and Bluetooth-enabled device is terminated.

- **Security**

Security standards can be set for the Bluetooth connection.

- **Normal**
- **High**

Link Info

The **Link Info** menu item shows whether the receiver is linked to a generator.

If there is an existing link, the device number of the generator is displayed, amongst other things.

Link TX

A generator can be assigned to the receiver in the **Link TX** menu item.

Further information about establishing a link can be found in section 7.1.1.

Unlink TX

An existing link between a receiver and generator can be disconnected in the **Unlink TX** menu item.

Further information about unlinking can be found in section 7.1.2.

4.2.5 Options

The following can be set in the **Options** menu item:

- **Audio**
- **Gain**
- **L/R Arrows**
- **Autodepth**
- **Offset Depth**
- **User Interface**

4.2.5.1 Audio

The following can be set in the **Audio** menu item:

- **Audio Mode**
- **Audio Style**
- **Center Beep**

Audio Mode

The type of audible sound can be set in the **Audio Mode** menu item.

- **Pitch**

The tone pitch of the signal can vary (high/low).

- **Volume**

The volume of the signal can vary (loud/quiet).

Audio Style

The way in which the sound is reproduced for the audible sound can be set in the **Audio Style** menu item.

- **Classic**
- **Smooth**

Center Beep

If the receiver is directly above a line during the locating process, a special signal tone can be emitted. The signal tone can be enabled and disabled in the **Center Beep** menu item.

- **On**

A signal tone is emitted directly above a line.

- **Off**

No signal tone is emitted.

4.2.5.2 Gain

Received signals generally have to be enhanced on the receiver. The way in which the received signals are enhanced can be set in the **Gain** menu item.

- **Manual**

The gain can be set manually by the user in increments until the required level is achieved.

- **Semi-auto** (semi-automatic)

The device automatically determines the optimum gain. The user can then continue to adjust the gain manually.

Note:

In **Autogain** locating mode the gain is adjusted automatically.

Information about adjusting the gain can be found in section 7.4.

4.2.5.3 L/R Arrows

A compass is displayed during measuring mode in **Line** and **Power** location modes. In the **L/R Arrows** menu item, you can set whether the compass is displayed with or without the following graphical elements:



Fig. 14 provides a comparison of both display types.

- **On**

Display of the compass with directional arrow or diamond.

- **Off**

Display of the compass without the directional arrow or diamond.

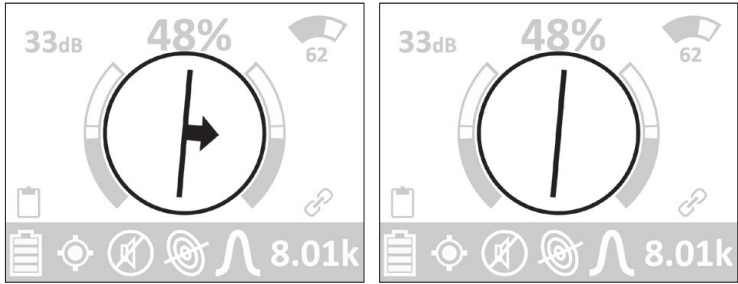

Fig. 14: Receiver display – measuring mode (here: **UtiliGuard2** user interface)

Left image: Compass with directional arrow

Right image: Compass without directional arrow

4.2.5.4 Autodepth

The way in which the depth is determined can be set in the **Autodepth** menu item.

- **Auto**

The depth is displayed automatically as soon as the receiver is directly above the location object.

- **Manual**

The depth can be determined manually by the user by pressing the Mode key.

Further information about determining the depth can be found in section 7.7.

4.2.5.5 Offset Depth

The determination of the offset depth can be enabled or disabled in the **Offset Depth** menu item.

- **On**

The offset depth is determined.

- **Off**

The offset depth is not determined.

Further information about the offset depth can be found in section 7.7.3.

4.2.5.6 User Interface

The type of display (fig. 5) for measuring mode can be set in the **User Interface** menu item.

- **UtiliGuard2**
- **Classic**

4.3 Utility Type menu

The saved measurements are shown as measuring points in the map view of the **UT 9200 Com** app. The measuring points in this view can have certain colours.

To specify the colour, the type of line to be displayed can be selected in the **Utility Type** menu.

- **None**
- **Electric**
- **Gas**
- **Communications**
- **Water**
- **Sewer**
- **Fiber**
- **Other**

The following colours are permanently assigned to the line types:

- red: **Electric**
- orange: **Communications, Other**
- yellow: **Gas**
- green: **Sewer**
- blue: **Water**
- violet: **None, Fiber**

4.4 Metrics menu

Statistical information about the use of the receiver and interconnected generator are displayed in the **Metrics** menu.

The information is spread over several display views.

- Press the arrow keys to see all of the information.

4.5 System Info menu

Information about the receiver, such as the serial number and software version, are displayed in the **System Info** menu.

The information is spread over several display views.

- Press the arrow keys to see all of the information.

4.6 Ambient Noise menu

In the **Ambient Noise** menu item you can determine which of the enabled frequencies are present in the environment and at what intensity.

Further information about the ambient noise can be found in section 7.6.

4.7 TX Control menu

Note:

The **TX Control** menu is only available if the receiver is linked to a generator.

During measuring mode the generator can be controlled by the receiver using the **TX Control**.

The following can be adjusted to the current location scenario:

- **Power setting**
- **Dual Output**

Switches the assignment of the current flow between the red and white cable. The blocked cable is shown with a line running through it.

Information about the default configuration and assignment of cables during parallel connection can be found in section 8.1.1.2.

Further information about TX Control can be found in section 7.5.

5 Generator UT 9012/9005 TX

5.1 General information

Lines can be energised directly and indirectly with the generator. The generator is therefore also often referred to as the transmitter.

Various frequencies are available for energising. The most common frequencies are set as part of the factory settings (section 13.2.2).

You will find an overview of the generator parts inside the front cover (fig. 3).





As long as the volume on the generator is switched on, a signal will sound to secure the work area.

Product variants

Generator	UT 9012 TX	UT 9005 TX
for systems	UT 9200 and UT 9100	
Difference	12 Watt output power	5 Watt output power

5.2 Operating modes

Indirect and direct energising are referred to as operating modes on the **UT 9012/9005 TX**. Symbols are used to show the selected operating mode on the display (fig. 15).

Operating mode	Energise with
Indirect energising	 cable clamp
	 generator without accessories
Direct energising	 simple cable set
	 splitter cable (twin cable set)

5.3 Control panel

You will find an overview of the control panel elements inside the front cover (fig. 4).

The keys have several functions. Symbols next to the keys illustrate the additional functions.

Volume key

On/Off



- switch on the generator
 - press and hold the key
- switch off the generator
 - press and hold the key

Volume



- In transmitting mode:
- switch the volume on and off
 - briefly press the key

Back



- In the menu:
- switch back to the next level up
 - briefly press the key
-

Frequency key f+

Frequency



- In transmitting mode:
- increase the frequency
 - briefly press the key
-

Frequency key f-

Frequency



- In transmitting mode:
- reduce the frequency
 - briefly press the key
-

Power key

Power setting 

In transmitting mode:

- select power setting
 - briefly press key repeatedly

Menu



In transmitting mode:

- open menu
 - press and hold the key

Next



In the menu:

- switch to the next level down
 - briefly press the key

Select



In the menu:

- select settings (enable/disable)
 - briefly press the key

5.4 Transmitting mode and menu

When switched on the generator is automatically in transmitting mode.

You can switch from transmitting mode to the main menu. The main menu has submenus in which the user can implement settings and view information.

5.4.1 Display in transmitting mode

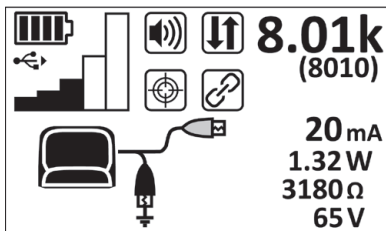

Fig. 15: Generator display – transmitting mode

In transmitting mode the current settings and states are shown on the left of the display using symbols. The frequency and current values are shown on the right.

An overview of the symbols that may appear on the display can be found in section 13.3.

Frequency display

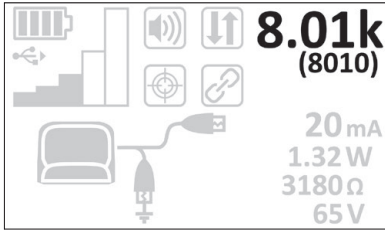

Fig. 16: Generator display – frequency

The set frequency is shown on the top right of the display. For frequencies greater than 1000 Hz, the value is shown in kHz and Hz.

Display of other values

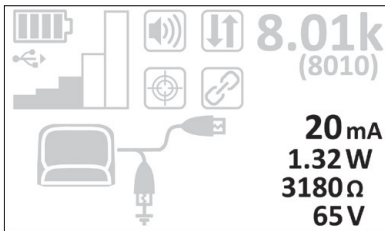

Fig. 17: Generator display – other values

Other values that can be displayed, for example, include the resistance between the connection points and the current.

Which values are actually displayed is dependent on:

- operating mode
- the **Meter** settings

Information about the settings can be found under **Meter** in section 6.3.3.

5.4.2 Display with main menu

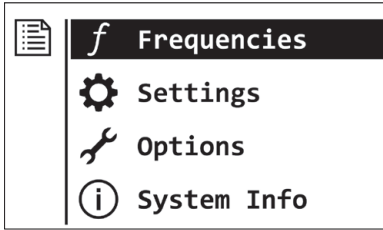

Fig. 18: Generator display - main menu

Information about the menus can be found in section 6.

5.4.3 Navigating the menus

The control panel keys can be used to navigate the main menu and submenus.

Opening the main menu

The generator is in transmitting mode.

- Press and hold the Power key. The main menu opens.

Selecting a menu item in a menu

The generator shows a menu. The currently selected menu item is highlighted.

1. Use the Frequency keys to select a menu item.
2. Press the Power key. The menu item appears.

Changing settings (enable/disable menu item)

The generator shows a menu in which menu items can be enabled or disabled. The currently selected menu item is highlighted.

1. Use the Frequency keys to select a menu item.
2. Press the Power key.
 - If the menu item was disabled (no checkmark set), it is enabled.
 - If the menu item was enabled (checkmark set), it is disabled.

3. Press the Volume key. The setting is applied. The generator switches back to the next level up.

Switching back to the next level up from a menu

The generator shows a menu or a menu item.

- Press the Volume key. The generator switches back to the next level up.

5.5 Power supply

The generator can optionally be operated with batteries or with a special lithium-ion rechargeable battery.

Different battery compartment lids (fig. 19) must be used depending on the power source.

Power source	Battery compartment lid features
Batteries	battery holder is on the inside of the battery compartment lid
Lithium-ion rechargeable battery	rechargeable battery is built into the battery compartment lid

So that they can be distinguished, the battery compartment lids have a sticker on the outside specifying the power source being used.



Fig. 19: Generator

Top image: Generator with open battery compartment

Bottom left image: Battery compartment lid for batteries

Bottom right image: Battery compartment lid with integrated lithium-ion rechargeable battery

5.5.1 Powered by batteries

Ten alkaline batteries LR20, mono D are required for the power supply.

Replacing the batteries

The battery compartment lid is sealed with quick-release fasteners.

The generator is switched off.

1. Open the battery compartment by turning the quick-release fasteners.
2. Remove the used batteries.
3. Insert the new batteries. Ensure that the polarity is correct (fig. 20).
4. Close the battery compartment.
5. Check the generator is ready for operation.
 - To do so, switch on the generator.

If the polarity of the batteries is not correct, you will not be able to switch on the generator.

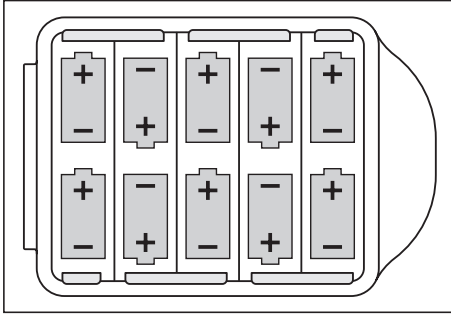

Fig. 20: Replacing the generator batteries – polarity of the batteries

5.5.2 Powered by lithium-ion rechargeable battery

A special lithium-ion rechargeable battery is required for the power supply. The rechargeable battery is built into the battery compartment lid (fig. 19).

The lithium-ion rechargeable battery can be purchased as an accessory.

Please observe the following information about the rechargeable battery:

- Safety information: section 1.5
- Charging and storage: section 12.1.1 and section 12.1.2
- Handling faulty lithium-ion rechargeable batteries: section 12.1.3

6 Generator menus

6.1 Main menu (overview)

The main menu comprises the following menus:

- **Frequencies**
- **Settings**
- **Options**
- **System Info**

The main menu can be opened when the generator is in transmitting mode.

Information about navigating the menus can be found in section 5.4.3.

6.2 Frequencies menu

The preset frequencies can be enabled and disabled in the **Frequencies** menu. Symbols indicate for which operating modes the individual frequencies are suitable.

The fewer frequencies are enabled, the faster you can switch between the frequencies during measuring mode.

Additional information about the frequencies can be found in section 7.3.

6.3 Settings menu

The following can be set in the **Settings** menu:

- **Backlight**
- **Output**
- **Meter**
- **Communications**

6.3.1 Backlight

The **Backlight** menu item can be used to set whether and for how long the display is illuminated.

- **On**

The display is illuminated for a certain time. The duration is dependent on the setting in the **Timer** menu item.

- **Off**

The display is not illuminated.

- **Timer**

The backlight automatically switches off after the set amount of time if the generator is not operated in the meantime. Default setting is 5 seconds.

– **5 | 10 | 20 | 40 Seconds**

Note:

The **Timer** menu item is only available if the **On** menu item is enabled.

6.3.2 Output

Note:

The **Output** menu item is only available if a cable set is connected to the generator. The cable set must be connected during transmitting mode, i.e. before the main menu is opened.

The following special output signal functions can be enabled in the **Output** menu item:

- **Direction Enabled** (direction detection)
- **High Power**
- **Dual Output** (splitter cable)

Direction Enabled

The direction detection can be enabled or disabled in the **Direction Enabled** menu item.

- **Enabled**
- **Disabled**

Further information about direction detection can be found in section 8.3.

High Power

An increased output power of the generator (12 W instead of 7 W) can be enabled in the **High Power** menu item.

- **Enabled**

The output power is increased for a certain amount of time. The duration is dependent on the setting in the **Timer** menu item.

- **Disabled**

The enabled output power is switched off before the value set under **Timer** expires.

- **Timer**

The output power is reduced from 12 W back to 7 W following the set amount of time. Default setting is 5 minutes.

- **5 | 10 | 15 | 20 Minutes**

Further information about the **High Power** function can be found in section 8.4.

Dual Output

For the purpose of direct energising, the connected cable set and default configuration for the splitter cable can be specified in the **Dual Output** menu item.

- **Enabled**

The splitter cable can be used.

- **Disabled**

The simple cable set can be used.

- **Output Select**

Default configuration for direct energising using a splitter cable. The current flows through the selected cable.

- **Red Lead**

- **White Lead**

Note:

The generator does not automatically detect which cable set is connected.

- SEWERIN recommends: Only enable the **Dual Output** function for as long as the splitter cable is actually being used (section 8.1.1.1).
-

Information about the default configuration and assignment of cables during parallel connection can be found in section 8.1.1.2.

6.3.3 Meter

In the **Meter** menu item you can set the extent to which other values (fig. 17) are displayed.

- **Simple**
- **Advanced**

The display is dependent on the operating mode.

Meter	Indirect energising		Direct energising
	Generator without accessories	With cable clamp	
Simple	<ul style="list-style-type: none">● power (as percentage of output power) [%]	<ul style="list-style-type: none">● current [mA]	<ul style="list-style-type: none">● current [mA]
Advanced	<ul style="list-style-type: none">● power (as percentage of output power) [%]● voltage [V]	<ul style="list-style-type: none">● current [mA]● voltage [V]	<ul style="list-style-type: none">● current [mA]● power [W]● resistance [Ω]● voltage [V]

6.3.4 Communications

The interaction between the receiver and generator can be set in the **Communications** menu item.

- **Radio On/Off**
- **Link RX**
- **Un-Link RX**
- **Link Info**

An overview of the differences between linking/connecting, unlink/unpair and Radio On/Off can be found in section 13.4.

Radio On/Off

The radio connection between the receiver and generator can be interrupted and established again in the **Radio On/Off** menu item. It may, for example, be necessary to interrupt the radio connection if you wish to establish a reliable connection to a Bluetooth-enabled device.

Note:

Interrupting the radio connection does not disable the connection between the receiver and generator.

- **On**

A radio connection is established between the receiver and generator.

- **Off**

An existing radio connection between the receiver and generator is interrupted.

Link RX

The **Link RX** menu item shows information about the link connection while a receiver and the generator are being linked.

Further information about establishing a link can be found in section 7.1.1.

Un-Link RX

An existing link between a receiver and generator can be disconnected in the **Un-Link RX** menu item.

Further information about unlinking can be found in section 7.1.2.

Link Info

The **Link Info** menu item shows whether the generator is linked to a receiver.

If there is an existing link, the device numbers of the receiver and generator are displayed, amongst other things.

6.4 Options menu

The following can be set in the **Options** menu:

- **Language**
- **Shutdown Timer**
- **Fault Mode**

6.4.1 Language

The language of the user interface can be set in the **Language** menu item.

6.4.2 Shutdown Timer

The **Shutdown Timer** menu item can be used to set the time after which the generator will switch off automatically if it is not operated in the meantime.

- **2 | 4 | 8 Hours**

The generator switches off after the set time has elapsed.

- **Always On**

The generator does not switch off automatically.

6.4.3 Fault Mode

Note:

The **Fault Mode** menu item is only available if a cable set is connected to the generator. The cable set must be connected during transmitting mode, i.e. before the main menu is opened.

A step-voltage probe can be enabled and disabled in the **Fault Mode** menu item.

When the receiver is switched off, the function is deactivated automatically.

- **Enabled**

The step-voltage probe can be used.

- **Disabled**

The step-voltage probe cannot be used.

6.5 System Info menu

Information about the generator is displayed in the **System Info** menu. The information can be spread over several display views.

– Press the Frequency key f- to see all of the information.

7 Using the system

7.1 Establishing a radio connection between devices

The receiver and generator can communicate with one another via a bi-directional radio connection. The devices must be linked for this purpose. The device number is used as the identification feature.

The link only has to be established once. Linked devices recognise one another again as long as the devices are not disconnected.

7.1.1 Linking the receiver and generator

A generator is assigned to a receiver during the linking process. If a receiver and generator are linked, the linking symbol is shown on the displays of both devices.

Receiver and generator are switched on.

1. On the receiver:

– In the menu select: **Configuration > Settings > Communications > Link TX.**

A message appears.

2. On the generator:

– In the menu select: **Settings > Communications > Link RX.**

Wait until the initialisation is complete.

3. On the receiver:

a) Press the Frequency key. The search for suitable devices is started.

A list of device numbers for the available devices is shown.

b) Select the required device.

c) Press the Frequency key. The link is established.

A message appears as soon as the receiver and generator are linked successfully.

7.1.2 Unlinking the receiver and generator

The link on both devices must be disconnected individually to release the existing device assignment.

Receiver and generator are switched on.

1. On the generator:

a) In the menu select: **Settings** > **Communications** > **Unlink RX**. A question will appear.

The question will also appear if there is no connection between the generator and a receiver.

b) Select **OK** if you want to disconnect the link.

c) Press the Power key. The link is disconnected.

The linking symbol is no longer displayed in measuring mode.

d) Switch the generator off and then on again.

2. On the receiver:

a) In the menu select: **Configuration** > **Settings** > **Communications** > **Unlink TX**. A question will appear.

b) Select **Unlink** if you want to disconnect the link.

c) Press the Frequency key. The link is disconnected.

The linking symbol is no longer displayed in measuring mode.

d) Switch the receiver off and then on again.

7.2 Adjusting the volume or switching off the sound

The volume of the sound changes continuously during the locating process. The volume on the receiver must therefore be adjusted as required to prevent any hearing damage or to be able to hear the sound better.



CAUTION! Health hazard

Excessive noise can damage the hearing and lead to irreversible damage to health.

- Always adjust the volume to the current situation, especially if you are using headphones.
 - Choose as low a volume as possible.
-

Three volume levels are available. The sound is switched off in the fourth level.

The receiver is in measuring mode.

- Briefly press the Volume key repeatedly until the required volume is set. The volume changes with each keystroke.

7.3 Setting the frequency

Frequencies can be available, preset and enabled. Only enabled frequencies can be used for the locating process.

- **Available frequencies**

There are 75 available frequencies in the **UT configurator** software. Available frequencies can be selected and transferred to a device. (By transferring the frequencies, they become preset frequencies on the device.)

- **Preset frequencies**

Preset frequencies are a selection of the available frequencies. The preset frequencies are listed under **Frequencies** in the menu on the device.

The most common frequencies are set as part of the factory settings. If different or additional frequencies are required, these must be transferred to the device using the **UT configurator** software.

An overview of the preset frequencies in the factory settings can be found in section 13.2.

- **Enabled frequencies**

Enabled frequencies are a selection of the preset frequencies.

Frequencies required for the locating process must be enabled while frequencies that are not required can be disabled.

7.3.1 Enabling frequencies

Notes:

- The fewer frequencies are enabled, the faster you can switch between the frequencies during measuring or transmitting mode.
 - The more frequencies are enabled, the more accurately the ambient noise can be determined before the locating process.
 - Please note that certain frequencies are only suitable for certain locating and operating modes (section 13.2).
-

Required frequencies must be enabled on the generator as well as the receiver.

Receiver and generator are switched on.

1. On the generator:
 - a) In the menu select: **Frequencies**.
 - b) Enable the required frequencies. Disable any frequencies that are not required.
2. On the receiver:
 - a) In the menu select: **Configuration > Frequencies**.
 - b) Enable the required frequencies. Disable any frequencies that are not required.

7.3.2 Selecting a frequency

An optimum location result can only be achieved if the receiver and generator are working with the same frequency. All of the enabled frequencies can be selected.

- In **Beacon** locating mode the frequency on the receiver must match the frequency of the beacon.
- During the following location modes the frequency can be changed during the locating process until the optimum frequency is found.
 - active locating: **Line, Autogain**
 - passive locating: **Power**

The frequency can optionally be changed on the receiver or generator.

Changing the frequency on the receiver

If the frequency on the receiver is changed then the frequency on the generator is switched over automatically if the receiver and generator are linked.

If the receiver and generator are not linked the frequency on the generator must then be set manually.

The receiver is in measuring mode.

- Press the Frequency key. The frequency changes when the key is pressed.

Changing the frequency on the generator

If the frequency on the generator is changed the frequency on the receiver must then be set manually.

The generator is in transmitting mode.

- Press one of the Frequency keys. The frequency changes when the key is pressed.

7.4 Adjusting the gain

During the locating process, the signal reception on the receiver can be too weak or too strong. This effect is counteracted by readjusting the gain.

The following applies to the gain:

- high gain > high signal sensitivity: locating possible at greater distance from the generator
- low gain > low signal sensitivity: may reduce overloading

The gain is adjusted manually or semi-automatically depending on the setting.

Note:

The gain cannot be adjusted by the user in **Autogain** locating mode.

Adjusting the gain manually

The gain of the receiver is set to **Manual** (**Configuration > Options > Gain**). The receiver is in measuring mode.

- Press the Up key several times or press and hold the key to increase the gain.
- Press the Down key several times or press and hold the key to decrease the gain.

Adjusting the gain semi-automatically

The gain of the receiver is set to **Semi-auto** (**Configuration > Options > Gain**). The receiver is in measuring mode.

- Press the Up key once if the gain is too low.
- Press the Down key once if the gain is too high.

7.5 Controlling the generator with the receiver (TX Control)

In measuring mode the generator can be controlled from the receiver. During this process, the power and dual output can be adjusted to the current location scenario. A splitter cable must be connected to the generator to control the dual output.

Information about the dual output can be found in section 6.3.2.

The receiver and generator are switched on and linked. The settings are implemented on the receiver.

1. In the menu select: **TX Control**.

The display view of the generator is shown on the receiver. The function symbol, for which the settings can be changed, flashes.

- Press the arrow keys to switch between the power setting and dual output.
- Press the Frequency key to change the associated settings.

2. Press the Mode key to apply the settings.





7.6 Ambient noise detection

There are almost always frequencies in the environment of a line being located that will make the locating process more difficult (interference signals). The ambient noise can be determined so that in the given situation a highly suitable frequency can still be selected for the energising and locating process. During this process the receiver will check the signal strength of the active frequencies in the environment.

Note:

The ambient noise can only be determined in the **Line** and **Power** location modes and only for enabled frequencies.

Suitability of a frequency for the locating process

Locating method	Locating mode	Signal strength (interference signal)	
		high	low
active	Line	 frequency not suitable	 frequency suitable
passive	Power	 frequency suitable	 frequency not suitable

Appropriate specialist knowledge is required to decide which of the suitable frequencies can actually be used for energising and locating.

Ambient noise detection and applying the best frequency

The generator is switched off. The receiver is switched on.

1. On the receiver:
 - a) Use the Mode key to select **Line** or **Power**.
 - b) In the menu select: **Ambient Noise**.

The ambient noise is determined. The receiver scans the environment for all of the enabled frequencies to determine the signal strength. The result is shown on the display (fig. 21).

The ambient noise for the highlighted frequency is updated in real time.

- Press one of the arrow keys if the ambient noise for a different frequency should be updated in real time.

If more than eight frequencies are enabled then the frequencies are shown on several display views.

- Press one of the arrow keys repeatedly until the top or bottom frequency is highlighted. If you then press the arrow key again, the frequencies on the previous or following display view are shown.

c) Use the arrow keys to select a frequency from the suitable frequencies.

d) Press the Mode key.

The selected frequency is applied.

2. Switch on the generator.

3. Wait until the receiver and generator are linked.

The receiver automatically transfers the selected frequency to the generator if the frequency is enabled on the generator.

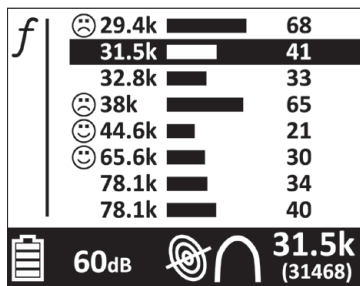

Fig. 21: Receiver display – ambient noise (*here: **Line** locating mode*)

The ambient noise for the highlighted frequency is updated in real time.

7.7 Determining the depth

The depth specifies the distance between the bottom edge of the receiver and centre of the line. When locating beacons the depth up to the centre of the beacon is determined.

Note:

Please note before any excavation that the depth always refers to the centre of the electromagnetic field. The top edge of lines with a large diameter may therefore not be as deep as specified.

The depth can be determined automatically or manually. The determined value can be displayed in various units (**Configuration > Settings > Units**).

7.7.1 Determining the depth automatically

The receiver is switched on.

1. Enable the automatic depth measurement.
 - To do so, in the menu select: **Configuration > Options > Autodepth > Auto**.
2. Switch back to measuring mode.
3. Start the locating process.

The depth is displayed automatically as soon as the receiver is directly above the location object.

If the receiver is no longer above the location object then no value for the depth is shown.

Note:

If the locating process is being completed over distorted fields then the depth may not be able to be determined automatically by the receiver. In such cases the depth can be determined manually.

7.7.2 Determining the depth manually

The receiver is switched on.

1. Enable the manual depth measurement.
 - To do so, in the menu select: **Configuration > Options > Autodepth > Manual**.

2. Switch back to measuring mode.
3. Start the locating process, moving until the receiver is directly above the location object.
4. Press and hold the Mode key until there is an audible signal tone.

The depth is shown.

7.7.3 Determining the offset depth

The offset depth can be determined in addition to the simple depth measurement. The receiver also determines the distance to the location object during this process. fig. 9 provides an overview of the offset depth on the display.

The function is useful in the following instances:

- obstructions above the line being located prevent a direct depth measurement
- results of a simple depth measurement must be checked for plausibility

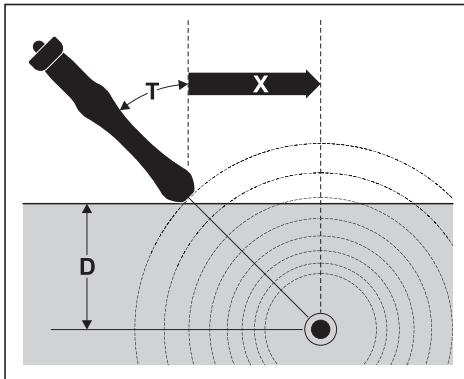

Fig. 22: Determining the offset depth using triangulation
 D – depth of location object
 X – distance between receiver/location object
 T – pitch of receiver (between 10° and 60°)

The offset depth can be determined automatically or manually.

Determining the offset depth automatically

The offset depth is determined automatically if the receiver settings for the depth and offset depth are as follows:

- **Configuration > Options > Autodepth > Auto**

AND

- **Configuration > Options > Offset Depth > On**

Determining the offset depth manually

The receiver is switched on.

1. Enable the **Offset Depth** function.
 - To do so, in the menu select: **Configuration > Options > Offset Depth > On**.
2. Start the locating process.
 - a) Position the receiver parallel to the suspected location of the line.
 - b) Tilt the receiver at an angle (T) between 10° and 60° (fig. 22).
 - c) As soon as directional arrows appear on the display:
 - Move in the direction indicated by the arrows.
 - Vary the pitch of the receiver during this process.The directional arrows change into a diamond as soon as the receiver is positioned in an optimum position.
3. Press the Mode key. The values for the depth and distance are shown.

7.8 Evaluating saved locating results externally

Note:

The functions described in the following are only available for receiver **UT 9200 R**.

Measurements can be saved during the locating process. To evaluate the saved measurements, they must be exported on to an external Bluetooth-enabled device.

Note:

Saved measurements cannot be accessed or evaluated on the receiver.

Saved and subsequently exported measurements can be used to document locating processes and to visualise the routes of lines.

7.8.1 Saving a measurement

Each saved measurement represents a measuring point with the following details:

- geographical coordinates
- depth and offset depth¹ of the location object
- date, time
- current settings on the receiver

The receiver is in measuring mode and has satellite reception.

– Press and hold the Mode key.

The measurement is saved. The symbol **Measurement saved** appears briefly.

7.8.2 Connecting the receiver to a Bluetooth-enabled device

The receiver and a suitable external device must be connected to one another to exchange data via Bluetooth.

The connection only has to be established once. Devices linked via Bluetooth recognise one another again as long as the devices are not unpaired.

The **UT 9200** app is installed on the external device. The receiver and external device are switched on.

1. On the receiver:

a) In the menu select: **Configuration > Settings > Communications > Bluetooth > Connect.**

The search for Bluetooth-enabled devices is started. The available devices are listed one after the other.

¹ if enabled

b) Select the required device.

c) Press the Frequency key.

The message **Connecting...** appears. A connection request appears on the external device.

2. On the device:

– Confirm the connection request.

3. On the receiver:

The message **Device paired** appears. The receiver switches back to the **Bluetooth** menu.

7.8.3 Unpairing the receiver and Bluetooth-enabled device

Devices connected via Bluetooth can be unpaired again.

The receiver and paired device are switched on. The settings are implemented on the receiver.

1. In the menu select: **Configuration > Settings > Communications > Bluetooth > Unpair.**

A list of devices connected via Bluetooth is shown.

2. Select the required device.

3. Press the Frequency key.

The device is removed from the list.

4. Press the Mode key.

The receiver switches back to the **Bluetooth** menu.

7.8.4 Reading out measurements

Saved measurements can be transferred to an external device by the receiver. All of the (individually) saved measurements in the receiver are combined into a single file when they are read out. The memory of the receiver is cleared at the same time.

Requirements for reading out:

- external, Bluetooth-enabled device on which the **UT 9200 Com** app is installed
- receiver and the device are switched on and paired (section 7.8.2)

Reading out measurements is started via the app. No further steps are required on the receiver.

SEWERIN recommends: Read out the measurements after each locating process is completed if you require a clear visualisation of the location of the line.

7.9 **Configuring or updating the receiver and generator via the software**

The **UT configurator** software is required to configure the receiver and generator and update the firmware on these devices. The device that should be configured or updated must be connected to the computer on which the software is installed.

The current software version is installed on a computer.

1. On the device (receiver, generator):
 - Unscrew the cover on the USB port.
2. Connect the device and computer using the USB cable.
3. On the computer:
 - a) Start the software.
 - b) Click **Connect** in the **Software Update** tab. The connected device is detected.
 - c) Use the software to update or configure the device as required.
4. Disconnect the device from the computer.
5. On the device:
 - Carefully seal the USB port with the cover again.

8 Active locating of lines

During active locating, a generator generates an electromagnetic field around the lines being located. The energised line can thus be located.

The active locating of lines is completed in three steps:

1. Ambient noise detection (section 7.6)
2. Energising a line (section 8.1)
3. Locating a line (section 8.2)

8.1 Energising a line

The line is energised directly or indirectly during the active locating process.

8.1.1 Direct energising

During direct energising power from a generator is supplied into the line being located via a cable. The prerequisite is that an electrical connection can be made on an exposed part of the line.

A generator and set of cables are required for the energising process. Simple and twin versions of the cable sets are available. Twin cable sets, also known as a splitter cable, are designed for parallel connections (section 8.1.1.2). Cable sets can be purchased as accessories.

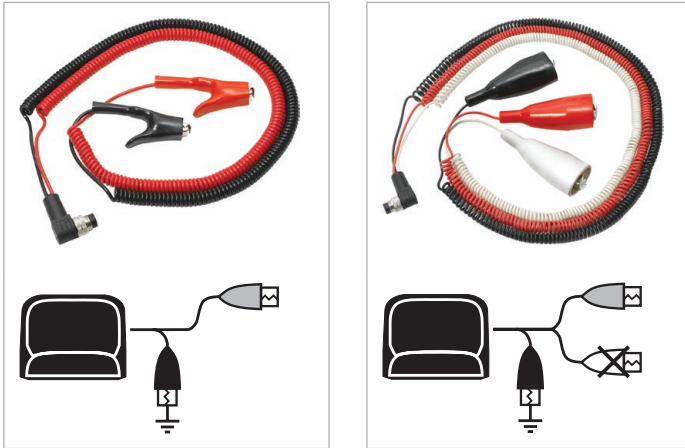

Fig. 23: Cable sets (above) and associated symbols (below)

Left image: Simple cable set

Right image: Splitter cable (twin cable set)

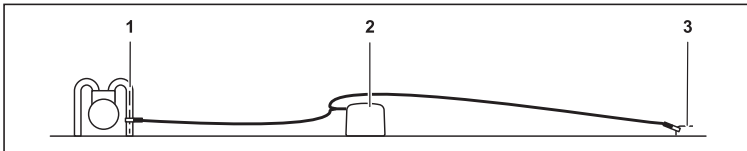

Fig. 24: Arrangement of the devices during direct energising

1 electrical connection to the line being located

2 generator

3 earthing spike

The connection between the three connection points is established with a cable set.



WARNING!

Danger of electrical shock from high voltage

High voltages may be present at exposed parts of lines.

- Observe the specified sequence of actions.
- Always switch off the generator before moving the earthing spike.

The generator is switched off.

1. Insert an earthing spike firmly into the ground.
Position the earthing spike at an angle of 90° to the line, if possible.
2. Connect the cable set to the generator (port for accessories).
3. Connect the black cable from the cable set to the earthing spike.
4. Connect the red cable from the cable set to the existing line.
5. Switch on the generator.
6. Select a suitable power setting.

The line is energised with the selected power.

8.1.1.1 Enabling/disabling the connected cable set

The generator detects if a cable set is connected and indicates this with a symbol on the display (fig. 23).

Note:

The generator only detects that a cable set is connected but not what type (simple cable set or splitter cable). The symbol always shows the type preset in the **Dual Output** menu.

- The setting must be changed if the correct symbol for the connected cable set is not displayed.
-

The generator is switched on.

- In the menu select: **Settings > Output > Dual Output**.
- Select **Enabled** if a splitter cable is connected.
- Select **Disabled** if a simple cable set is connected.

8.1.1.2 Parallel connection (splitter cable)

During a parallel connection, two lines are connected to the generator at the same time using a splitter cable.

During measuring mode the receiver can control which of the two connections, i.e. which line, the generator will energise. The

other connection is switched off. This process saves time as the connections do not need to be changed as frequently.

Note:

Lines connected in parallel cannot be energised at the same time.

When working with a parallel connection the following must be differentiated:

- **Default configuration**



The default configuration specifies which cable from the splitter cable will be energised at the start of the locating process and which cable will be blocked. The default configuration is specified on the generator in the **Output** menu.

- **Assignment**

During the locating process, **TX Control** on the receiver can be used to switch between the energised and blocked cable of the splitter cable.

Information about TX Control can be found in section 7.5.

Default configuration of the cable (factory settings)

Colour of the cable	Assignment	Symbol
black	earth	
red	current	
white	blocked	

Changing the default configuration

A splitter cable is connected to the generator. The generator is switched on.

1. In the menu select: **Settings > Output > Dual Output > Enabled.**

The **Output Select** menu item appears.

2. Select **Output Select** from the menu.
3. Select the cable through which the current should flow.

8.1.2 Indirect energising

Indirect energising is used if there is no exposed connection on the line that is being located to which the generator could be connected.

The following options are available for indirect energising:

- energising without accessories on the generator section 8.1.2.1
- energising with a cable clamp section 8.1.2.2

8.1.2.1 Energising without accessories on the generator

Only a generator is required for the energising process. The line must be made of metal.

The generator is positioned directly above the line being located. The electromagnetic field generated by the generator causes a current flow in the line being located.

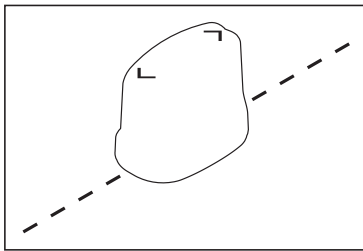

Fig. 25: Alignment of the generator to the line during indirect energising

The generator is switched off.

1. Position the generator so that its longitudinal axis is parallel above the line being located (fig. 25).

The angle between the line and longitudinal axis of the generator must not exceed a maximum of 15°.

2. Switch on the generator.

3. Select a suitable power setting.

The line is energised with the selected power.

8.1.2.2 Energising with a cable clamp

A generator and cable clamp are required for the energising process.

Individual cables can be energised selectively using the cable clamp without being directly coupled to the cable. The cable does not have to be activated.

The cable clamp can be purchased as an accessory.



WARNING!

Danger of electrical shock from high voltage

If the cable clamp is attached to a single power current cable then high voltages can be generated in the cable clamp. These voltages can cause shock currents or destroy the receiver.

- Only use the cable clamp if it has been ensured that the current rating in the power current cables does not exceed 300 A.

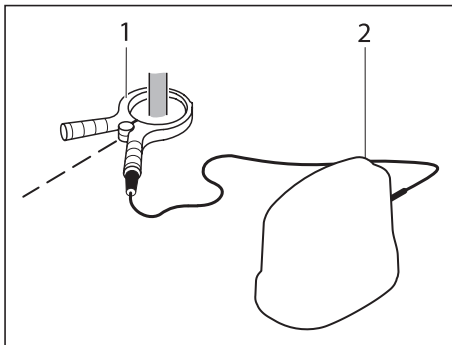

Fig. 26: Arrangement of the devices when energising with a cable clamp
1 cable clamp
2 generator

The generator is switched off.

1. Connect the cable of the cable clamp to the generator.
2. Connect the cable clamp to the cable being located.

- Observe the information in the operating instructions for the cable clamp during this process.
3. Switch on the generator.
 4. Select a suitable power setting.
The line is energised with the selected power.

8.2 Locating a line

A requirement for the active locating of a line is that the line is energised (section 8.1).

Note:

When locating indirectly energised lines, there is a possibility that the field of the generator is accidentally located.

- When indirectly locating energised lines using the receiver, maintain a distance of approx. 15 m to the generator.
-

The line is energised. The receiver is switched on.

1. On the receiver:
 - Select the following settings:
 - Locating mode: **Line**
 - Antenna: **Twin, Single or Null**
2. Hold the receiver vertically downwards.
3. Detect the ambient noise so you can start the location with a particularly suitable frequency.
4. Locate the line.
 - To do so, evaluate the reaction of the receiver (see following overview).

Reaction of the receiver when locating a line	
Audio	maximum directly over the line
Field strength	maximum directly over the line
Gain	adjust as required, multiple times if necessary
Directional arrows	change into a diamond directly over the line
Compass needle	shows the position of the line
Depth	for automatic depth measurement: value appears as soon as the receiver is directly above the line
Current	current on the line is stronger than the current on a neighbouring line on to which the current signal has jumped over

8.3 Using direction detection

Notes:

- The **Direction detection** function is only available in **Line** locating mode and only for frequencies of 8 – 10 kHz.
 - If the **High Power** function is enabled then the **Direction detection** function on the receiver is not available.
-

If there are other lines in the vicinity of the line that is being located this can result in incorrect detections. The reason for this is that neighbouring lines can accidentally be energised at the same time.

The direction detection helps to prevent incorrect detections. After determining the first measuring points, the direction detection can be used to check whether the correct line is being located. If this is the case, detection of the line location can be continued.

- The current on the line that is being located, i.e. the energised line, flows away from the generator.
- The current, on a line to which the current has jumped over, flows towards the generator.

When the direction detection is switched on, the direction of the current flow on the receiver is indicated by an arrow on the compass needle (fig. 27).

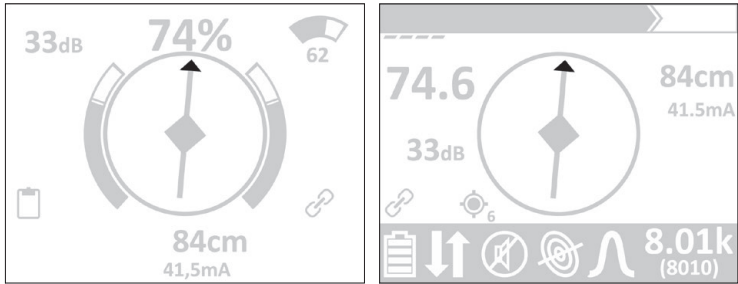

Fig. 27: Receiver display – direction detection (arrow on compass needle)
 Left image: **UtiliGuard2** user interface
 Right image: **Classic** user interface

The receiver and generator are switched on and linked. At least one measuring point has been located on an energised line.

1. On the generator:
 - Enable direction detection.
 - a) Connect a cable set.
 - b) In the menu select: **Settings > Output > Direction Enabled > Enabled.**

The **Direction detection** symbol appears on the generator display.
2. On the receiver:
 - a) Select the following settings:
 - Locating mode: **Line**
 - Antenna: **Twin, Single** or **Null**
 - Frequency: **8 – 10 kHz**

The **Direction detection** symbol appears on the display.
 - b) Stand on the located line with your back to the generator.
 - c) Press the Frequency key until a sound is emitted. An arrow on the compass needle indicates the direction of the current flow.

Note:

If you switch to a frequency of less than 8 kHz or more than 10 kHz during measuring mode, the **Direction detection** function switches off automatically. If you then switch back to a frequency between 8 kHz and 10 kHz, the function automatically switches on again.

8.4 Energising with a high power

Note:

The **High Power** function is only available for generator **UT 9012 TX** in **Direct energising** operating mode and only for frequencies of less than 10 kHz.

Generator **UT 9012 TX** has a maximum output power of 12 W. During normal measuring mode, the generator energises at the highest power setting up to a maximum of 7 W to reduce the power consumption. The **High Power** function enables the generator to energise with an output power of 12 W for a certain amount of time.

The function is particularly suitable for locating processes completed over long distances.

The function can only ever be enabled for the currently set frequency. If the frequency is changed during measuring mode, the function switches off automatically. The function must be enabled again to be able to be used.

If using the **High Power** function frequently or for long periods, SEWERIN recommends: The use of a lithium-ion rechargeable battery for the power supply of the generator.

The generator is switched on.

1. As required: Change the preset duration (5 min.) for energising at 12 W.
 - To do so, select the required duration in the menu: **Settings** > **Output** > **High Power** > **Timer**.

2. In the menu select: **Settings > Output > High Power > Enabled.**

The generator switches back to transmitting mode and energises with 12 W. The **High Power** symbol appears on the display.

9 Active locating of beacons

Lines that are not electroconductive can be located using beacons (locating transmitters). These are placed in the line. When switched on, beacons generate an electromagnetic field which can be located by the receiver.

Beacons come in different shapes and sizes. They can also be integrated in cameras used for line diagnostics. Beacons can be purchased as accessories.

The receiver is switched off. The beacon is ready.

1. Switch on the beacon.
 - Observe the information in the operating instructions for the beacon during this process.
2. Switch on the receiver.
3. Select the following settings on the receiver:
 - Locating mode: **Beacon**
 - Antenna: **Total Field**
 - Frequency: same as frequency of the beacon
4. Check that the beacon is working and can be located by the receiver.
 - To do so, perform a location test outside of the line.
5. Insert the beacon into the line to be located.
6. Hold the receiver vertically downwards.
7. Locate the beacon.
 - To do so, evaluate the reaction of the receiver (see following overview and fig. 28).

Reaction of the receiver when locating a beacon	
Audio	maximum directly over the beacon
Field strength	maximum directly over the beacon
Gain	adjust as required, multiple times if necessary
Directional arrows	change into a diamond directly over the beacon
Points	show the position of the beacon
Depth	<p>for automatic depth measurement: value appears as soon as the receiver is directly above the beacon</p> <p>The depth up to the centre of the beacon is determined. This generally does not equate exactly to the centre.</p>

	Approaching	Align	Determine position and depth
Signal curve			
Locating situation			
As shown on the receiver display			

Fig. 28: Steps to locate a beacon

10 Passive locating

Electromagnetic fields, that are already present on a line that is being located, are used for the passive locating process. Only the receiver and not the generator is required for this locating process.

The following network frequencies can be located:

- 50 Hz, 100 Hz, 150 Hz (Europe)
- 60 Hz, 120 Hz, 180 Hz (North America, etc.)

Note:

Only enabled frequencies can be used for the locating process.



Fig. 29: Alignment of the receiver with the suspected location of the line

The receiver is switched on.

1. Use the Mode key to select **Power** or **Radio**.
2. Hold the receiver vertically downwards.
3. Only in **Power** locating mode:
 - Detect the ambient noise so you can start the location with a particularly suitable frequency.
4. Hold the receiver and move within the suspected location of the line being located.
5. As soon as a specific signal is received clearly:
 - Position the receiver along the suspected location of the line, as illustrated in fig. 29.
6. Locate the line.
 - To do so, evaluate the reaction of the receiver (see following overview).

Reaction of the receiver during passive locating	
Audio	maximum or minimum directly over the line
Field strength	maximum or minimum directly over the line
Gain	adjust as required, multiple times if necessary
Depth	for automatic depth measurement, Power locating mode, frequency of 50 Hz: – value appears as soon as the receiver is directly above the line

Completing the locating process in **Radio** locating mode has special features in comparison to **Power** locating mode and the active locating process.

Special features in Radio locating mode	
Antenna	only Twin possible
Gain	only manual possible
Display	only gain and field strength visible (fig. 30)
Audible signals	no modulation – sounds similar to signal noise
Field strength	constantly high above the line being located – The field strength drops significantly as soon as the receiver is moved a little to the side of the line being located.

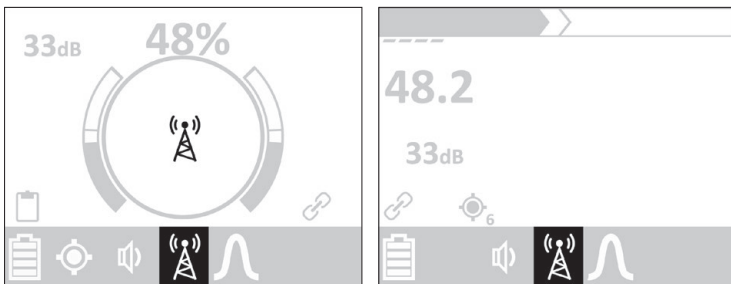

Fig. 30: Receiver display – passive locating using **Radio** locating mode
Left image: **UtiliGuard2** user interface
Right image: **Classic** user interface

11 Locating with special accessories

Note:

The following provides a description of accessories for special locating tasks. The accessories are only available for receiver **UT 9200 R**.

The receiver automatically detects which accessory is connected.

11.1 Step-voltage probe (locating cable faults)

The step-voltage probe can be used to locate cable faults on electric supply lines.

The following is required to locate a cable fault:

- receiver
- generator
- splitter cable
- step-voltage probe

A sticker on the top of the step-voltage probe indicates the required alignment of the step-voltage probe and receiver during the locating process (fig. 31).

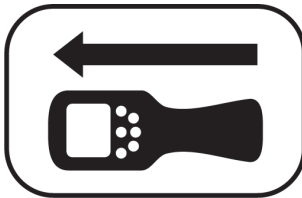

Fig. 31: Sticker on the step-voltage probe

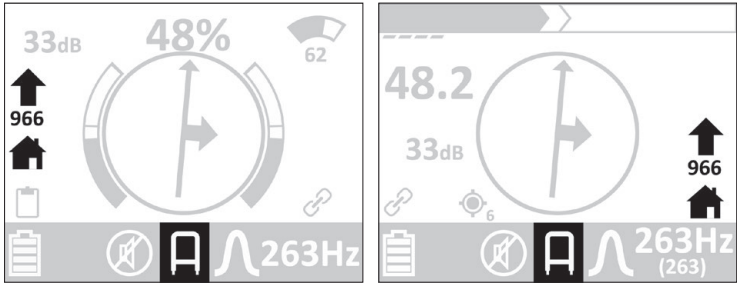

Fig. 32: Receiver display – step-voltage probe connected (*here: cable fault signal 966*)

Left image: **UtiliGuard2** user interface

Right image: **Classic** user interface

The supply line that should be checked for cable faults must be energised directly (section 8.1.1). If the step-voltage probe is enabled, the abbreviation **FF** (Fault Finder) is shown on the generator display instead of the frequency (fig. 33).

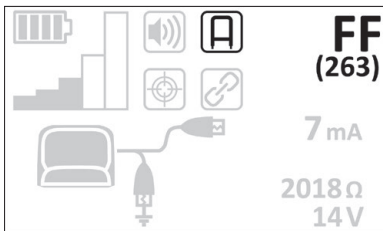

Fig. 33: Generator display – step-voltage probe connected (*here: step-voltage probe symbol, FF (263)*)

11.1.1 Approaching a cable fault

The following graphical elements can appear on the display when approaching a cable fault:



Reference point

- The receiver requires information about the direction of the current flow.



Directional arrows

- The receiver and step-voltage probe must be moved in the displayed direction.

When approaching a cable fault, the cable fault signal (numerical value) increases (fig. 32 and fig. 34).

The directional arrow will change direction directly over a cable fault. The cable fault is then located in the centre underneath the step-voltage probe (fig. 34).

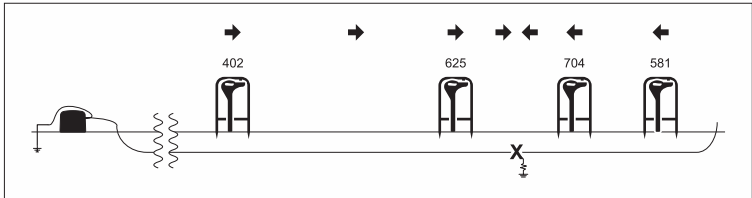

Fig. 34: Locating a cable fault with a step-voltage probe

11.1.2 Locating cable faults

Receiver and generator are switched off. The location of the line is known.¹

1. Properly disconnect the supply line that is going to be checked for cable faults.
2. On the generator.
 - a) Connect the splitter cable.
 - b) Connect the black cable of the splitter cable to the earthing spike.
 - c) Connect the red cable of the splitter cable to the existing supply line.
 - d) Switch on the generator.
 - e) In the menu select: **Options > Fault Mode > Enabled.**
 - f) Adjust the power setting, if required.
3. On the receiver.
 - a) Switch on the receiver.
 - b) Connect the step-voltage probe cable (port for accessories).

The **Reference point** symbol flashes on the display.

¹ SEWERIN recommends that you locate the line and mark the course of the line before starting to locate the cable fault.

4. Move approx. 1 m away from the connection point on the generator.
 - Move along the location of the line.
5. Place the step-voltage probe directly above or just next to the line on the floor.
 - Correctly align the step-voltage probe and receiver using the sticker (fig. 31).

The arrow must be pointing away from the connection point on the generator.
 - On soft substrates: Push the step-voltage probe into the ground.
6. Press and hold the Frequency key.

The **Reference point** symbol disappears.
7. Locate the cable fault.
 - Move along the line with the receiver and step-voltage probe.
 - Place the step-voltage probe directly above or just next to the line on the floor.

On soft substrates: Push the step-voltage probe into the ground.
 - Move the step-voltage probe back and forth to get closer to the cable fault (fig. 34).
 - Always ensure that the alignment of the step-voltage probe and receiver correspond to the sticker (fig. 31).

The arrow must always point away from the connection point even if the user moves in the opposite direction.

11.2 Marker ball antenna (locating a marker)

The marker ball antenna can be used to accurately pinpoint passive markers.

The following is required to locate a marker:







- receiver
- marker ball antenna



Fig. 35: Marker ball antenna with receiver

11.2.1 General information

The marker ball antenna enables markers with the following frequencies to be located:

Frequency	Use	Colour of the marker
66.3 kHz	 no drinking water	violet
77.0 kHz	 communication	orange/black
83.0 kHz	 gas	yellow
101 kHz	 telephone	orange
121 kHz	 sewer	green
134 kHz	 current	red/blue
169 kHz*		red
145 kHz	 water	blue

* Not available in the EU. May only be used in countries outside the EU as long as the frequency is not subject to any usage restrictions.

When using the marker ball antenna, the following are shown on the receiver display (fig. 36):

- frequency
- use (symbol and colour of marker²)
- marker selection
- antenna battery status
- antenna software version

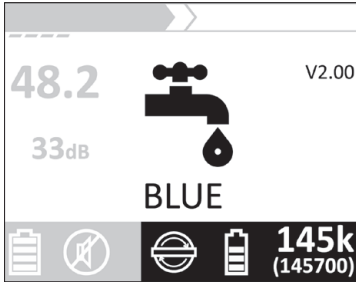



Fig. 36: Receiver display – marker ball antenna connected (*here*: frequency 145 kHz / **Water** symbol, marker selection **Automatic**, software version V2.00)
The display is the same for both user interfaces.

Marker selection

The frequency of a marker must be known to locate a marker. If the frequency is not known, the receiver can scan the surrounding area for existing marker signals.³

The marker selection determines how the frequency of the marker is set on the receiver.

Marker selection	Suitable locating objects
 Manual	marker for which the frequency is known
 Auto	marker for which the frequency is not known

The marker selection can be set with the Mode key.

² The colour is shown as text in English.

³ Only for enabled frequencies.

Power supply

The antenna is powered by batteries. The battery status is shown in the toolbar on the receiver display (fig. 36).

Note:

The toolbar shows two symbols for the battery status.

- left symbol: battery of the receiver
 - right symbol: battery of the marker ball antenna
-

Replacing the batteries

Ten alkaline AA batteries are required for the power supply.

The battery compartment lid is sealed with a quick-release fastener.

1. Open the battery compartment by turning the quick-release fastener.
2. Carefully remove the battery holder.
3. Remove the used batteries.
4. Insert the new batteries. Ensure that the polarity is correct.
5. Replace the battery holder.
6. Close the battery compartment.

11.2.2 Connecting the receiver and marker ball antenna

The receiver and marker ball antenna must be connected mechanically and electrically to one another.

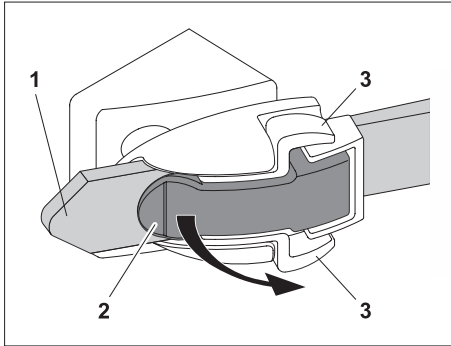

Fig. 37: Marker ball antenna – ratchet strap lock
 1 ratchet strap
 2 lever
 3 lock (two-part)

1. Position the antenna on a solid, even base.
2. Release the ratchet strap (fig. 37).
 - To do so, push both parts of the lock to the rear and pull the strap at the same time.
3. Place the receiver in the recess on the antenna.
4. Secure the receiver with the ratchet strap.
 - a) Push the ratchet strap into the lock.
 - b) Pull the lever forwards repeatedly until the receiver is securely enclosed.
5. Connect the antenna cable to the receiver (port for accessories).

11.2.3 Locating marker with known frequency

The **Manual** marker selection is used to locate markers of known frequencies.

The receiver and antenna are connected mechanically and electrically (section 11.2.2). The receiver is switched on.

1. Use the Mode key to select **Manual**.
2. Select the frequency.
 - The frequency on the receiver must match the frequency of the marker.
3. Hold the receiver vertically downwards.

4. Locate the marker.
 - To do so, evaluate the reaction of the receiver (see following overview).

Reaction of the receiver when locating a marker	
Audio	maximum directly over the marker
Field strength	maximum directly over the marker
Gain	adjust as required, multiple times if necessary

11.2.4 Locating unknown marker

The **Auto** marker selection is used to locate markers of unknown frequencies.

The receiver and antenna are connected mechanically and electrically (section 11.2.2). The receiver is switched on.

1. Use the Mode key to select **Auto**.
2. Hold the receiver vertically downwards.

The receiver continuously scans the environment.

- The frequency of the marker with the strongest signal (highest field strength) is set automatically.

If the user moves the receiver into the area of a marker with a different frequency:

- The receiver automatically changes the frequency as soon as the signal of the new marker is stronger than the signal of the previous marker.

3. Locate the marker.
 - To do so, evaluate the reaction of the receiver (see overview under “Locating marker with known frequency” on page 84).

11.2.5 Disconnecting the receiver and marker ball antenna

The receiver and marker ball antenna are connected mechanically and electrically to one another. Both of the connections must be disconnected.

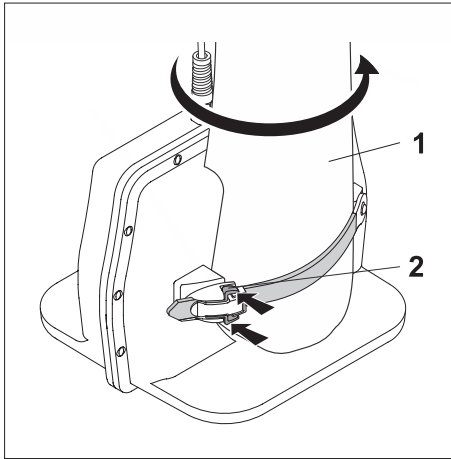

Fig. 38: Marker ball antenna – disconnecting the receiver and antenna
 1 receiver
 2 lock (two-part)

1. Position the antenna on a solid, even base.
2. Disconnect the antenna cable from the receiver.
3. Release the ratchet strap (fig. 38).
 - To do so, push both parts of the lock to the rear.
 AND simultaneously:
 - Turn the receiver until the ratchet strap is so loose that the receiver can be removed.

11.3 Receiver clamp (locating cable bundle)

The receiver clamp can be used to locate cable bundles in electric installations.

The receiver clamp can be used for:

- active locating (**Line** locating mode)
- passive locating (**Power** locating mode)

The following is required to locate a cable bundle:

- receiver
- receiver clamp
- generator and cable set are also required for active locating

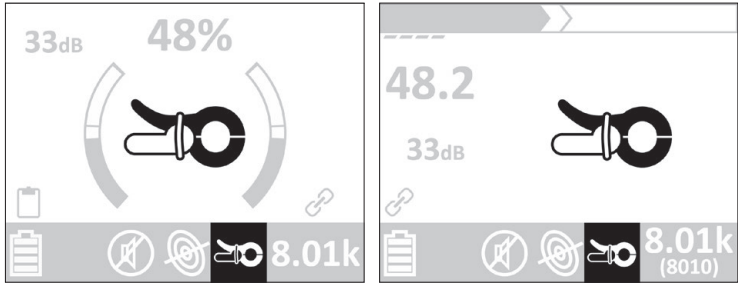

Fig. 39: Receiver display – receiver clamp connected
 Left image: **UtiliGuard2** user interface
 Right image: **Classic** user interface

WARNING!
Danger of electrical shock from high voltage
 High voltages may be present at exposed leads.
 • Only use the receiver clamp for insulated leads.

The receiver is switched on.

1. Connect the receiver clamp to the receiver (port for accessories).
2. Use the Mode key to select **Line** or **Power**.
3. Select the frequency.
4. Place the receiver clamp around a cable bundle.
5. Locate the cable bundle.
 - To do so, evaluate the reaction of the receiver.

Information about this:

- Active locating (**Line**): section 8.2
- Passive locating (**Power**): section 10

11.4 Receiving antenna (locating single leads)

A receiving antenna can be used to locate individual leads in cable bundles within electrical installations (e.g. control cabinets).

The receiving antenna can be used for:

- active locating (**Line** locating mode)
- passive locating (**Power** locating mode)

The following is required to locate a cable bundle:

- receiver
- receiver clamp
- generator and cable set are also required for active locating

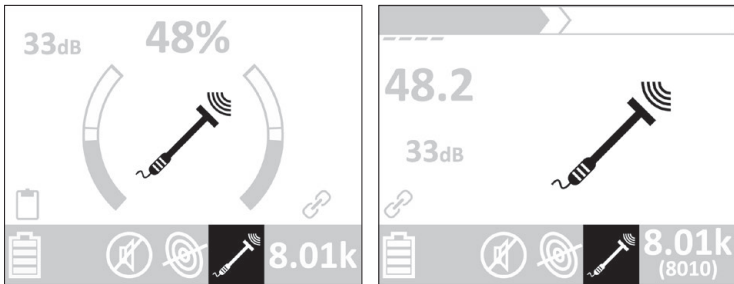

Fig. 40: Receiver display – receiving antenna connected

Left image: **UtiliGuard2** user interface

Right image: **Classic** user interface



WARNING!

Danger of electrical shock from high voltage

High voltages may be present at exposed leads.

- Only use the receiving antenna for insulated leads.
-

The receiver is switched on.

1. Connect the receiving antenna to the receiver (port for accessories).
2. Use the Mode key to select **Line** or **Power**.
3. Select the frequency.
4. Locate the lead.
 - Move the receiving antenna over each lead of the cable bundle in turn.

- Evaluate the reaction of the receiver.

Information about this:

- Active locating (**Line**): section 8.2
- Passive locating (**Power**): section 10

12 Maintenance and error management

12.1 Lithium-ion rechargeable battery (generator)

The generator can be operated with a special lithium-ion rechargeable battery.

Note:

Observe the safety information about the rechargeable battery (section 1.5).

12.1.1 Storing rechargeable batteries

If the rechargeable battery is going to be stored for long periods, it must be prepared for storage and maintained during storage.

Note:

Observe the permissible storage conditions (section 13.1.2).

Preparing for storage

- Before storage, charge or discharge the rechargeable battery to a remaining capacity of 30 – 50%.

Rechargeable battery maintenance during storage

Rechargeable batteries that have completely self-discharged can no longer be charged.

- You should charge the rechargeable battery every 6 months to prevent it from completely self-discharging. Only charge the rechargeable battery up to a remaining capacity of approx. 30 – 50%.

12.1.2 Charging the rechargeable battery

The **UT 9012** AC/DC adapter is required for the charging process. The rechargeable battery, i.e. the special battery compartment lid, must be removed from the generator. There is a charging socket on one of the longitudinal sides of the battery compartment lid.

The LED on the AC/DC adapter shows the charge status of the rechargeable battery:

LED	Charge status
red	rechargeable battery is being charged
green	rechargeable battery is fully charged (charging process complete) The LED also lights up green if the AC/DC adapter is connected to the power supply without the rechargeable battery being connected to the AC/DC adapter.

The battery compartment lid is sealed with quick-release fasteners.

The generator is switched off.

1. Open the battery compartment by turning the quick-release fasteners. Remove the battery compartment lid.
2. Connect the rechargeable battery to a suitable power source using the **UT 9012** AC/DC adapter.

The rechargeable battery is charged.

3. When the rechargeable battery is fully charged, disconnect the rechargeable battery from the power source.
4. Place the battery compartment lid back on the battery compartment. Close the battery compartment.

12.1.3 Handling faulty lithium-ion rechargeable batteries

Lithium-ion batteries are always classed as dangerous goods for transport purposes.

The transportation of faulty lithium-ion batteries is only permitted under certain conditions (e.g. must not be transported as air freight). Where transportation is permitted (e.g. by road or rail), it is subject to strict regulations. Faulty lithium-ion batteries must therefore always be removed before shipping. Transportation by

road or rail must occur in compliance with the current applicable version of the ADR¹ regulations.

Identifying faulty rechargeable batteries

A lithium-ion rechargeable battery is considered to be faulty if one of the following criteria applies:²

- housing damaged or badly deformed
- liquid leaking from battery
- smell of gas from battery
- rise in temperature with the receiver switched off (more than hand-hot)
- plastic parts melted or deformed
- connection leads melted

12.2 Care

All that is necessary to care for the receiver and generator is to wipe it down with a damp cloth.

SEWERIN recommends: always remove significant contamination immediately.

Displays

The display surface of the devices are sensitive to mechanical and chemical stress.

- Always use a clean, soft cloth to clean the displays.
- Never use cleaning agents containing aggressive constituents (e.g. acidic or abrasive constituents).

12.3 Servicing

SEWERIN recommends: Have the receiver and generator serviced regularly by SEWERIN Service or an authorised

¹ French abbreviation for: Accord européen relatif au transport international des marchandises Dangereuses par Route, *Engl.: European Agreement concerning the International Carriage of Dangerous Goods by Road

² According to: EPTA – European Power Tool Association

professional. Only regular servicing can ensure that the devices are always ready for use.

12.4 Solving problems

12.4.1 Source of errors during the locating process

Interference fields are the most common sources of error. Interference fields can distort the electromagnetic fields along the line, thus producing erroneous location results. This can apply to both the position and depth of the line or beacon.

Electromagnetic fields that are too weak or distorted can also lead to incorrect location results. Distorted fields, for example, occur if other lines cross the line being located or if there are junctions or curves.

Adjacent lines

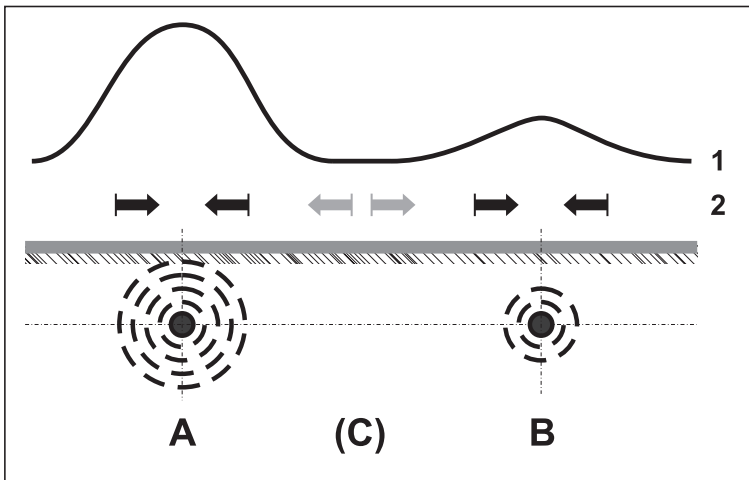

Fig. 41: Locating situation for adjacent lines
A line to be located (directly energised)
B other line
1 signal curve
2 directional arrows

Fig. 41 shows a locating situation where another line (B) is positioned closely next to the line being located (A). Line A is

energised directly. The signal curve (1) shows a maximum above both lines.

Users that predominantly rely on sound for the locating process can make the mistake of detecting a fictional line C between line A and line B.

This mistake cannot occur if the directional arrows on the display are observed during the locating process. The directional arrows indicate in which direction a line runs. The directional arrows change into a diamond when positioned directly over the line. As C is not a line, no diamond will appear.

12.4.2 Problems with the receiver

Problem	Possible cause	Corrective action
Receiver cannot be switched on	remaining capacity of batteries too low	<ul style="list-style-type: none"> replace the batteries
	power supply interrupted	<ul style="list-style-type: none"> check battery contacts
Receiver does not react after being switching on	receiver faulty	<ul style="list-style-type: none"> briefly remove the batteries, then insert again > switch on the receiver again
	remaining capacity of batteries too low	<ul style="list-style-type: none"> replace the batteries
No audible sound	sound switched off or volume set too low	<ul style="list-style-type: none"> increase volume
Display shows unusually fluctuating values	interference fields present	<ul style="list-style-type: none"> remove interference fields: e.g. switch off computers, monitors, light dimmers, industrial devices
Active locating: Field strength too strong (at minimum gain)	receiver too close to the generator	<ul style="list-style-type: none"> move receiver away from generator

12.4.3 Problems with the generator

Problem	Possible cause	Corrective action
Generator cannot be switched on	remaining capacity of batteries too low	<ul style="list-style-type: none"> replace the batteries charge rechargeable battery
Generator does not transmit after being switching on	generator faulty	<ul style="list-style-type: none"> check function of generator: switch on receiver and generator > detect ambient noise: the receiver must receive a significant signal strength of the frequency set on the generator.
	remaining capacity of batteries too low	<ul style="list-style-type: none"> replace the batteries charge rechargeable battery
Direct energising does not working	line is not electroconductive	<ul style="list-style-type: none"> system is unsuitable > use special accessory (e.g. fiber glass probe) or other system (e.g. COMBIPHON)
	electric circuit interrupted	<ul style="list-style-type: none"> use earthing spike
	no or low current in the line being located	
	cable set defective	<ul style="list-style-type: none"> replace cable set
	cable set not connected correctly	<ul style="list-style-type: none"> check cable set connection
Indirect energising does not working	generator not positioned correctly above the line being located	<ul style="list-style-type: none"> position generator differently
Generator shuts down during the locating process	power supply insufficient	<ul style="list-style-type: none"> select lower power setting replace the batteries

13 Appendix

13.1 Technical data

13.1.1 Receiver UT 9200/9100 R

Device data

Dimensions (W × D × H)	120 × 325 × 705 mm
Weight	2.2 kg (with batteries)

Certificates

Certificate	CE, FCC, IC
Marking	contains FCC ID: WAP3039 IC: 7922A-3039

Features

Display	graphics LCD, LED backlight with light sensor
Interface	mini USB
Operation	membrane keypad with 6 keys

Operating conditions

Operating temperature	-20 – 50°C
Humidity	10 – 90% r.h., non-condensing
Atmospheric pressure	950 – 1100 hPa
Protection rating	IP65
Non-permitted operating environments	in potentially explosive areas

Storage conditions

Storage temperature	-32 – 70°C
---------------------	------------

Power supply

Power supply	alkaline batteries LR20, mono D, two units
Operating time, typical	30 h

Data transmission

Transmission frequency	2.4 GHz
Radio range	max. 800 m
Communication	Bluetooth <ul style="list-style-type: none">• dual mode module (Bluetooth 4.0 (LE), Bluetooth Classic 2.1)• class 2

Location

Receiving frequency	<ul style="list-style-type: none">• 75 active frequencies between 256 Hz and 200 kHz• passive frequencies: 50/60/100/120/150/180 Hz
Location depth	<ul style="list-style-type: none">• max. 6 m• error:<ul style="list-style-type: none">◦ active locating: ±5% up to 3 m◦ passive locating: ±10% up to 3 m◦ beacon (locating transmitter): ±5% up to 3 m

Pinpointing via GNSS (UT 9200 R only)

Accuracy	2.5 m CEP, 50%
Antenna	integrated
Navigation systems	GPS, Galileo, GLONASS, Beidou

13.1.2 Generator UT 9012/9005 TX

Device data

Dimensions (W × D × H)	295 × 180 × 260 mm
Weight	3.75 kg (with batteries)

Certificates

Certificate	CE, FCC, IC
Marking	contains FCC ID: WAP3039 IC: 7922A-3039

Features

Display	graphics LCD, LED backlight with light sensor
Interface	mini USB
Operation	membrane keypad with 4 keys

Operating conditions

Operating temperature	-20 – 50°C
Humidity	10 – 90% r.h., non-condensing
Atmospheric pressure	950 – 1100 hPa
Protection rating	IP65
Non-permitted operating environments	in potentially explosive areas

Storage conditions

Storage temperature	<ul style="list-style-type: none">• with batteries: -32 – 70°C• with lithium-ion battery (rechargeable): -20 – 45°C, optimum: <21°C
Humidity	with lithium-ion battery (rechargeable): <80% r.h., non-condensing
Environment	with lithium-ion battery (rechargeable): free of corrosive gases

Power supply

Power supply	either: <ul style="list-style-type: none">• batteries: alkaline LR20, mono D, 10 units (as delivered)• lithium-ion battery (rechargeable) [9083-9007], built into special battery compartment lid
Net weight of batteries	weight per cell: 0.046 kg total: 16 × 0.046 kg = 0.736 kg
Operating time, maximum	<ul style="list-style-type: none">• with batteries: 100 h• with lithium-ion battery (rechargeable): 80 h
Battery power	130 Wh

Data transmission



















































Transmission frequency	2.4 GHz
Radio range	max. 800 m
Communication	Bluetooth <ul style="list-style-type: none">• dual mode module (Bluetooth 4.0 (LE), Bluetooth Classic 2.1)• class 2

Location

Transmitting frequency	75 active frequencies between 256 Hz and 200 kHz
Transmitting power	<ul style="list-style-type: none">• UT 9012 TX: 12 W, 5 power settings• UT 9005 TX: 5 W, 5 power settings
Transmitting current	max. 500 mA
Transmission voltage, effective	max. 65 V

13.2 Preset frequencies (factory settings)

13.2.1 Receiver UT 9200/9100 R

Frequency	suitable for
50 Hz	
60 Hz	
100 Hz	
120 Hz	
150 Hz	
180 Hz	
256 Hz	 
263 Hz	 
512 Hz	  
640 Hz	  
815 Hz	 
982 Hz	 
1.10 kHz	 
8.19 kHz	  
9.50 kHz	 
9.82 kHz	 
9.95 kHz	 
32.8 kHz	 
41.7 kHz	  
44.6 kHz	 
80.4 kHz	 
83.1 kHz	  
116 kHz	  
131 kHz	 
200 kHz	 

Symbol explanation:



Power



Line



Autogain

























































Beacon





Note about **Autogain**:

- The suitable frequencies are not displayed in the menu under **Frequencies**.
- The suitable frequencies are enabled if the same frequencies are enabled for **Line** locating mode.

13.2.2 Generator UT 9012/9005 TX

Frequency	suitable for
256 Hz	 
263 Hz	 
512 Hz	 
640 Hz	 
815 Hz	 
982 Hz	 
1.10 kHz	 
8.19 kHz	   
9.50 kHz	  
9.82 kHz	   
9.95 kHz	  
32.8 kHz	   
41.7 kHz	  
44.6 kHz	  
80.4 kHz	   
83.1 kHz	   
116 kHz	 
131 kHz	  
200 kHz	  

Symbol explanation:

-  Direct energising
-  Indirect energising
-  Cable clamp for low frequency
-  5" cable clamp

13.3 Symbols (meaning)

Symbols that are shown on the displays of the receiver and generator without a descriptive text are described in the following.

Modes



Line



Autogain



Power



Beacon



Radio

Antennas



Total Field



Twin



Single



Null

Basic information



Battery status



Volume switched on



Volume switched off



Direction detection

Interaction between the receiver and generator



Receiver and generator linked (link symbol)



Receiver and generator disconnected



Connection between receiver and generator interrupted



Frequency on generator not enabled



Generator transmitting



Generator not transmitting (no output power)



Generator not transmitting
(faulty connection during direct energising)

Power



Power setting



Dual Output



High Power

Satellite connection



Satellite search



Satellite reception

Ambient noise



Frequency suitable



Frequency not suitable



Ports

USB

Measurement data



Measurements can be saved



Measurement saved



Measurement could not be saved



Memory nearly full



Memory full

Accessories (except marker ball antenna)



Step-voltage probe



Reference point



Receiver clamp



Receiving antenna



Cable clamp



Cable set (simple cable set)



Splitter cable (twin cable set)



Generator without accessories

Marker ball antenna



Manual



Auto



No drinking water



Communications



Gas



Telephone



Sewer



Current



Water

13.4 Connecting or linking devices? Difference between radio and Bluetooth connection

Connection		Action
Type	between	– result
Radio	receiver (R) and generator (G)	Link RX Link TX – assigns R and G to one another
		Un-link RX Unlink TX – disconnects an existing link between R and G
		Radio > On – establishes a radio connection between R and G
		Radio > Off – disconnects the radio connection between R and G but not the link
Bluetooth	receiver (R) and (any) Bluetooth-enabled device (B)	Bluetooth > Connect – known as pairing – pairs R and B
		Bluetooth > Unpair – disconnects an existing connection between R and B

13.5 Accessories and consumables

Accessories

Part	Order number
UT euro lithium-ion rechargeable battery	UT90-Z0500
UT twin cable set (splitter cable)	UT90-Z0300
UT step voltage probe	UT90-Z1100
UT EU marker ball antenna	UT90-Z0600
UT receiving antenna	UT90-Z1400
UT receiver clamp	UT90-Z1500
UT 5" cable clamp	UT90-Z1000

Consumables

Part	Order number
Mono LR20 battery	1353-0003

Other accessories and consumables are available for the product. Please contact our SEWERIN sales department for further information.

13.6 Declaration of conformity

Hermann Sewerin GmbH hereby declares that receivers **UT 9200 R** and **UT 9100 R** fulfil the requirements of the following guideline:

- 2014/53/EU

Hermann Sewerin GmbH hereby declares that generators **UT 9012 TX** and **UT 9005 TX** fulfil the requirements of the following guidelines:

- 2014/30/EU
- 2014/35/EU
- 2014/53/EU

The complete declarations of conformity can be found online.

13.7 FCC Compliance Statements

This device complies with Part 15 of the FCC Rules. Operation is subject to the following conditions: (1) this device may not cause harmful interference, and (2) this device must accept any interference received, including interference that may cause undesired operation. Changes or modifications not expressly approved by The Charles Machine Works, Inc. could void the user's authority to operate the equipment.

This machine has been tested and found to comply with the limits for a Class A digital device, pursuant to Part 15 of the FCC rules. These limits are designed to provide reasonable protection against harmful interference when the equipment is operated in a commercial environment. This equipment generates, uses, and can radiate radio frequency energy, and, if not installed and used in accordance with the instructions, can cause harmful interference to radio communications. Operation of this equipment in a

residential area could cause harmful interference which the user will be required to correct at his own expense. Changes or modifications not expressly approved by The Charles Machine Works, Inc. could void the user's authority to operate the equipment.

This equipment has been tested and found to comply with the limits for a Class B digital device, pursuant to Part 15 of the FCC rules. These limits are designed to provide reasonable protection against harmful interference in a residential installation. This equipment generates, uses and can radiate radio frequency energy and, if not installed and used in accordance with the instructions, may cause harmful interference to radio communications. However, there is no guarantee that interference will not occur in a particular installation. If this equipment does cause harmful interference to radio or television reception, which can be determined by turning the equipment off and on, the user is encouraged to try to correct the interference by one or more of the following measures:

- Reorient or relocate the receiving antenna.
- Increase the separation between the equipment and receiver.
- Connect equipment into an outlet on a circuit different from that to which the receiver is connected.
- Consult the dealer or an experienced radio/TV technician for help.

13.8 Advice on disposal

The European Waste Catalogue (EWC) governs the disposal of devices and accessories in accordance with EU Directive 2014/955/EU.

Description of waste	Allocated EWC waste code
Device	16 02 13
Batteries	16 06 04
Lithium-ion rechargeable battery	16 06 05

Alternatively, devices can be returned to Hermann Sewerin GmbH.

14 Index

A

- Active locating 9, 61, 72
- Adjusting the volume 48
- Ambient Noise
 - detection 53
 - menu 31
- Antennas 10
 - menu 23
- Assignment 64
- Audio
 - mode 27
 - style 27
- Audio (menu) 27
- Autodepth (menu) 29
- Autogain
 - frequencies 100
 - locating mode 9

B

- Backlight 24, 40
- Beacon
 - active locating 72
 - locating 15
 - locating mode 10
- Bluetooth connection 58, 106
- Bluetooth (menu) 25

C

- Cable clamp 66
- Cable set 61
 - enabling/disabling 63
- Care 92
- Center Beep 27
- Classic (user interface) 30
- Colours for line types 30
- Communications (menu) 24, 44
- Compass 14
- Configuration (menu) 22
- Connecting 106
 - receiver to external device 58
- Current (locating mode) 9

D

- Default configuration 64
 - changing 64

Depth 54

- automatic determination 55
- display 17
- manual determination 55

Devices

- configuring/updating 60
- connecting 58
- linking 47
- unlinking 48
- unpairing 59

Diamond 15

- Direct energising 61
- Directional arrows 15
- Direction detection 41, 68
- Direction enabled (menu) 41

Display 13, 18, 34, 36

- Distinguishing battery compartment lids 37

Dual Output (menu) 42

E

Energising

- direct 61
- indirect 65
- with a cable clamp 66
- with high power 70
- without accessories on the generator 65

Evaluating 57

F

Fault Mode 46

Field strength 16

Frequencies

- available 49
- changing on generator 51
- changing on receiver 51
- enabled 49
- enabling 50
- menu 22, 40
- preset 49, 100
- setting 49
- suitability for locating 53

G

- Gain 16
 - adjusting 51
 - menu 27
- Generator 32
 - changing frequency 51
 - controlling with receiver 52
 - control panel 33
 - display in transmitting mode 34
 - display with main menu 36
 - keys 33
 - main menu 40
 - powered by batteries 38
 - powered by rechargeable battery 39
 - problems 95
 - product variants 32
 - switching off 33
 - switching on 33

H

- High Power 70
 - menu 42

I

- Indirect energising 65

K

- Keys 10, 33

L

- Language 23, 45
- Line
 - active locating 61
 - energising 61
 - locating 67
 - locating mode 9
- Link Info (menu) 26, 45
- Linking 106
 - receiver and generator 47
- Link RX (menu) 44
- Link TX (menu) 26
- Lithium-ion rechargeable battery 90
 - charge status (LED display) 91
 - charging 90
 - faulty 91
 - safety information 4
 - storing 90

Locating

- active 61
- beacon 15
- cable bundle 86
- cable fault 77
- display when approaching 14
- line 67
- lines, adjacent 93
- marker 80
- mode 9
- passive 75
- single leads 87
- source of errors 93
- suitable frequencies 53
 - with special accessories 77
- Locating the marker 80
 - known frequency 84
 - unknown frequency 85
- Locating transmitter *see* Beacon
- L/R Arrows 28

M

- Main menu 18, 36
 - opening 19, 36
- Marker ball antenna 80
- Marker selection 82
- Measurement
 - reading 59
 - saving 58
- Measuring mode 13
- Menu *see* Main menu
- Menu item
 - enabling/disabling 19, 36
 - selecting 19, 36
- Meter (menu) 43
- Metrics (menu) 30
- Modes (menu) 22

N

- Navigating the menus 19, 36
- Null (antenna) 10

O

- Offset Depth 56
 - automatic determination 57
 - manual determination 57
 - menu 29
- Operating modes 32

- Options (menu) 26, 45
- Output (menu) 41
- Output power 12 W 42, 70

P

- Parallel connection 63
- Passive locating 9, 75
- Pitch 27
- Power
 - locating mode 9
 - supply 20, 37
- Product variants 8, 32

R

- Radio connection 106
 - between devices 47
- Radio (locating mode) 10
- Radio On/Off (menu) 25, 44
- Receiver 8
 - adjusting the gain 51
 - changing frequency 51
 - clamp 86
 - control panel 10
 - display in measuring mode 13
 - display with main menu 18
 - keys 10
 - main menu 22
 - power supply 20
 - problems 94
 - product variants 8
 - switching off 11
 - switching on 11
 - toolbar 18
- Receiving antenna 87
- Rechargeable battery *see* Lithium-ion rechargeable battery
- Replacing the batteries 20, 38

S

- Satellite connection 20
- Selecting power setting 34
- Servicing 92
- Settings
 - changing 19, 36
 - menu 23, 40
- Shutdown Timer 24, 45

- Signal
 - indicator 14
 - tone 8
- Single (antenna) 10
- Solving problems 93
- Sound 8
- Splitter cable 42, 61, 63
- Step-voltage probe 77
- Switching
 - off 11, 33
 - off the sound 48
 - on 11, 33
- System
 - components 5
 - overview 5
- System Info (menu) 31, 46

T

- Toolbar 18
- Total Field (antenna) 10
- Transmitter *see* Generator
- Transmitting mode 34
- Twin (antenna) 10
- TX Control 52
 - menu 31

U

- Units 24
- Unlinking receiver and generator 48
- Un-Link RX (menu) 45
- Unlink TX (menu) 26
- Unpairing receiver and external device 59
- Use, intended 2
- User interface (menu) 30
- UT 9005 TX *see* Generator
- UT 9012 TX *see* Generator
- UT 9100 R *see* Receiver
- UT 9200 Com app 7
- UT 9200 R *see* Receiver
- UT configurator software 6, 60
- UtiliGuard2 (user interface) 30
- Utility Type (menu) 30



Hermann Sewerin GmbH

Robert-Bosch-Straße 3
33334 Gütersloh, Germany
Tel.: +49 5241 934-0
Fax: +49 5241 934-444
www.sewerin.com
info@sewerin.com

SEWERIN IBERIA S.L.

Centro de Negocios Eisenhower
Avenida Sur del Aeropuerto
de Barajas 28, Planta 2
28042 Madrid, España
Tel.: +34 91 74807-57
Fax: +34 91 74807-58
www.sewerin.com
info@sewerin.es

Sewerin Sp. z o.o.

ul. Twórcza 79L/1
03-289 Warszawa, Polska
Tel.: +48 22 675 09 69
Tel. kom.: +48 501 879 444
www.sewerin.com
info@sewerin.pl

SEWERIN SARL

17, rue Ampère – BP 211
67727 Hoerdt Cedex, France
Tél. : +33 3 88 68 15 15
Fax : +33 3 88 68 11 77
www.sewerin.fr
sewerin@sewerin.fr

Sewerin Portugal, Lda

Rua Sr. Dos Milagres, 16, 2º Esq
3800-261 Aveiro, Portugal
Tlf.: +351 234 133 740
Fax.: +351 234 024 446
www.sewerin.com
info@sewerin.pt

Sewerin Ltd.

Hertfordshire
UK
Phone: +44 1462-634363
www.sewerin.co.uk
info@sewerin.co.uk