



Operating Manual

**ALTAIR<sup>®</sup> 5X – Multigas Detector**

**ALTAIR<sup>®</sup> 5X IR – Multigas Detector**



Order No.: 10114801/04



*The Safety Company*

1000 Cranberry Woods Drive  
Cranberry Township, PA 16066  
USA

Phone 1-800-MSA-2222

Fax 1-800-967-0398

For your local MSA contacts please go to our website [www.MSAafety.com](http://www.MSAafety.com)



**EC Declaration of Conformity**

Mine Safety Appliances Company, LLC

Manufactured by: 1000 Cranberry Woods Drive  
Cranberry Township, PA 16066 USA

The manufacturer or his authorized representative established in the community

MSA Europe GmbH,  
Schlüsselstr.12,  
CH - 8645 Rapperswil-Jona

declares that the product:

**ALTAIR 5X, ALTAIR 5X IR**

based on the EC-Type Examination Certificate:

FTZU 08 ATEX 0340 X and FTZU 09 ATEX 0006 X

complies with the ATEX directive 94/9/EC, Annex III. Quality Assurance Notification complying with Annex IV of the ATEX Directive 94/9/EC has been issued by Ineris of France, Notified Body number: 0080.

ALTAIR 5X EN 60079-0:2012, EN 60079-1:2014, EN 60079-11:2012  
EN 60079-18:2009, EN 50303:2000  
EN 60079-29-1:2007, EN 50 104:2010, EN 50271:2010, EN 45544-1:1999  
EN 45544-2:1999

ALTAIR 5X iR EN 60079-0:2012, EN 60079-1:2014, EN 60079-7:2007  
EN 60079-11:2007, EN 60079-18:2009, EN 50303:2000, EN 60079-29-1:2007.  
EN 50 104:2010, EN 50271:2010, EN 45544-1:1999  
EN 45544-2:1999, EN 45544-2:1999

The product is in conformance with the Directive 2004/108/EC (EMC)

EN 50270:2006 Type 2, EN 61000 - 6 - 3:2011

The product is in conformance with the directive 2010/68 EC, (MED):  
EC-Type Examination Certificate: 213.050 Notified Body number: 0736

The product is in conformance with the Directive 1999/5/EC (R&TTE):  
EN 301 489-1, V1.9.2 , EN 301 489-3 V1.4.1. , EN 301 489-17 V2.2.1

The product is in conformance with the directive 93/68/EG (LVD):  
EN 61010-1:2010.

The product is in conformance with the Directive 2006/66/EC.

Paul Craig  
Marketing Director  
MSA Europe GmbH

Rapperswil-Jona,  
August 2015



# Contents

<b>1</b>	<b>Safety Regulations</b>	<b>7</b>
1.1	Correct Use	7
1.2	Liability Information	8
1.3	Safety and Precautionary Measures	8
<b>2</b>	<b>Description</b>	<b>11</b>
2.1	Overview	11
2.2	Device Hardware Interfaces	12
2.3	Alarms	13
2.4	On-Screen Indicators	14
2.5	Viewing Additional Pages	19
2.6	Sensor Missing Alarm	23
2.7	Monitoring Toxic Gases	23
2.8	Monitoring Oxygen Concentration	24
2.9	Monitoring Combustible Gases	24
<b>3</b>	<b>Operation</b>	<b>26</b>
3.1	Environmental Factors	26
3.2	Turning ON and Fresh Air Setup	27
3.3	Special Consideration for Oxygen Sensor	29
3.4	Measurement Mode (Normal Operation)	30
3.5	Device Setup	31
3.6	Bluetooth Operation	37
3.7	MSA Link Operation	38
3.8	Function Tests on the Device	38
3.9	Bump Test	39
3.10	Calibration	41
3.11	Time of Day Testing	45
3.12	Device Shutdown	45



<b>4</b>	<b>Maintenance .....</b>	<b>46</b>
4.1	Troubleshooting .....	46
4.2	Verifying Pump Operation .....	47
4.3	Replacing the Battery .....	48
4.4	Maintenance Procedure - Replacing or Adding a Sensor .....	49
4.5	Replacing the Pump Filter .....	51
4.6	Cleaning the Device Exterior .....	51
4.7	Storage .....	51
4.8	Shipment .....	51
<b>5</b>	<b>Technical Specifications .....</b>	<b>52</b>
5.1	Factory-set Alarm Thresholds and Setpoints .....	53
5.2	Performance Specifications .....	54
5.3	Calibration Specifications .....	56
5.4	Combustible Gas Cross Reference Factors for General-Purpose Calibration Using Calibration Cylinder (Part no. 10053022) .....	56
<b>6</b>	<b>Certification .....</b>	<b>57</b>
6.1	Marking, Certificates and Approvals According to the Directive 94/9/EC (ATEX) .....	57
6.2	Marking, Certificates and Approvals According to IECEx .....	61
<b>7</b>	<b>XCell Sensor Patents .....</b>	<b>63</b>
<b>8</b>	<b>Ordering Information .....</b>	<b>64</b>
8.1	US .....	64
8.2	Outside US .....	65
8.3	Accessories .....	65



**9 Appendix – Flow Charts ..... 70**

9.1 Basic Operation ..... 70

9.2 Bump Test/ Informational Pages ..... 71

9.3 Calibrations ..... 73

9.4 Setup ..... 74

9.5 Calibration Options ..... 75

9.6 Alarm Options ..... 76

9.7 Sensor Alarm Setup ..... 77

9.8 Instrument Options ..... 78

9.9 Sensor Setup ..... 80

**10 Changeable Feature Summary ..... 81**

US

# 1 Safety Regulations

## 1.1 Correct Use

The ALTAIR 5X and ALTAIR 5X IR Multigas Detectors, hereafter also referred to as device, are for use by trained and qualified personnel. They are designed to be used when performing a hazard assessment to:

- Assess potential worker exposure to combustible and toxic gases and vapors as well as low level of oxygen.
- Determine the appropriate gas and vapor monitoring needed for a workplace.

The ALTAIR 5X Multigas Detector can be equipped to detect:

- Combustible gases and certain combustible vapors.
- Oxygen-deficient or oxygen-rich atmospheres.
- Specific toxic gases for which a sensor is installed.
- US only: While the device can detect up to 30 % oxygen in ambient air, it is approved for use only up to 21 % oxygen.
- Outside the US: Oxygen for monitoring inertisation applications. The device is suitable and certified for the measurement of the oxygen concentration in gas mixtures for inertisation according to EN 50104 but without alarm function.

The ALTAIR 5X IR Multigas Detector can also contain one infrared sensor to detect CO<sub>2</sub> or specific combustible gases up to 100 % Vol.



### WARNING

- Perform a blocked flow test before each day's use.
- It is recommended that a Bump Test is performed before each day's use, and adjust if necessary.
- Perform a Bump Test more frequently if exposed to silicone, silicates, lead-containing compounds, hydrogen sulfide, or high contaminant levels.
- Recheck calibration if unit is subjected to physical shock.
- Use only to detect gases/vapors for which a sensor is installed.
- Do not use to detect combustible dusts or mists.
- For accurate catalytic combustible readings, make sure adequate oxygen is present (>10 % O<sub>2</sub>).
- Never block pump inlet, except to perform a sampling system safety test. Have a trained and qualified person interpret device readings. Risk of Explosion: Do not remove battery pack, recharge Li Ion battery, or replace alkaline batteries in a hazardous location. Do not alter or modify device.
- Use only MSA-approved sampling lines.
- Do not use silicone tubing or sampling lines.
- Wait sufficient time for the reading; response times vary based on gas and length of sampling line.
- Do not use the device for prolonged periods in an atmosphere containing a concentration of fuel or solvent vapors that may be greater than 10 % LEL.

Incorrect use can cause death or serious personal injury.

US only: This Class A digital apparatus complies with Canadian ICES-003.

It is imperative that this operating manual be read and observed when using the product. In particular, the safety instructions, as well as the information for the use and operation of the product, must be carefully read and observed. Furthermore, the national regulations applicable in the user's country must be taken into account for safe use.

Alternative use, or use outside this specification will be considered as non-compliance. This also applies especially to unauthorized alterations to the product and to commissioning work that has not been carried out by MSA or authorized persons.

## 1.2 Liability Information

MSA accepts no liability in cases where the product has been used inappropriately or not as intended. The selection and use of this product must be under the direction of a qualified safety professional who has carefully evaluated the specific hazards of the jobsite where it will be used and who is completely familiar with the product and its limitations. The selection and use of this product and its incorporation into the safety scheme of the jobsite is the exclusive responsibility of the employer.

Product liability claims, warranties also as guarantees made by MSA with respect to the product are voided, if it is not used, serviced or maintained in accordance with the instructions in this manual.

## 1.3 Safety and Precautionary Measures



### WARNING

Carefully review the following safety limitations and precautions before placing this device in service. Incorrect use can cause death or serious personal injury.

- Check function (see chapter 3.8) each day before use. MSA recommends carrying out a routine inspection prior to each day's use.
- It is recommended that a Bump Test is performed (see chapter 3.9) before each day's use to verify proper device operation. The device must pass the bump test. If it fails the test, perform a calibration (see chapter 3.10) before using the device.
- The ALTAIR 5X MultiGas Detectors are designed to detect gases and vapors in air only.
- Bluetooth Operation is dependent upon signal availability of the wireless service(s) necessary to maintain the communication link. Loss of wireless signal will prevent communication of alarms and other information to linked devices. Take appropriate precautions in the event a loss of wireless signal occurs.

Perform a Bump Test more frequently if the device is subjected to physical shock or high levels of contaminants. Also, check calibration more frequently if the tested atmosphere contains the following materials, which may desensitize the combustible gas sensor and reduce its readings:

- Organic silicones
- Silicates
- Lead-containing compounds
- Sulfur compound exposures over 200 ppm or exposures over 50 ppm for one minute.
- The minimum concentration of a combustible gas in air that can ignite is defined as the Lower Explosive Limit (LEL). A combustible gas reading of **XXX** indicates the atmosphere is above 100 % LEL, and an explosion hazard exists. Move away from hazardous area immediately.
- Do not use the device to test for combustible or toxic gases in the following atmospheres as this may result in erroneous readings:
  - Oxygen-deficient or oxygen-rich atmospheres
  - Reducing atmospheres
  - Furnace stacks
  - Inert environments (only IR sensors acceptable for use)
  - Atmospheres containing combustible airborne mists/dusts.
- Do not use the ALTAIR 5X and ALTAIR 5X IR Multigas Detectors to test for combustible gases in atmospheres containing vapors from liquids with a high flash point (above 38 °C, 100 °F) as this may result in erroneously low readings.
- Allow sufficient time for device to display accurate reading. Response times vary based on the type of sensor being utilized (→ chapter 5.2). Allow a minimum of 1 second per foot (3 seconds per meter) of sample line to allow the sample to be drawn through the sensors.
- Sampling lines made from 0.062 inch (1.57 mm) inner diameter tubing provide fast transport times to the device; however, they must be limited to 50 feet (15 m) in length.
- Sampling of reactive toxic gases (Cl<sub>2</sub>, ClO<sub>2</sub>, NH<sub>3</sub>) must only be done with the reactive gas sample line and probe kits listed in chapter 8.
- All device readings and information must be interpreted by someone trained and qualified in interpreting device readings in relation to the specific environment, industrial practice and exposure limitations.



- Outside the US: The device is suitable and certified for the measurement of the oxygen concentration in gas mixtures for inertisation according to EN 50104 without alarm function.

### Observe Proper Battery Maintenance

Use only battery chargers made available by MSA for use with this device; other chargers may damage the battery pack and the device. Dispose of in accordance with local health and safety regulations.

### Be Aware of Environmental Conditions

A number of environmental factors may affect the sensor readings, including changes in pressure, humidity and temperature. Pressure and humidity changes also affect the amount of oxygen actually present in the atmosphere.

### Be Aware of the Procedures for Handling Electrostatically Sensitive Electronics

The device contains electrostatically sensitive components. Do not open or repair the device without using appropriate electrostatic discharge (ESD) protection. The warranty does not cover damage caused by electrostatic discharges.



This equipment has been tested and found to comply with the limits for a Class A digital device, pursuant to part 15 of the FCC Rules. These limits are designed to provide reasonable protection against harmful interference when the equipment is operated in a commercial environment. This equipment generates, uses, and can radiate radio frequency energy and, if not installed and used in accordance with the instruction manual, may cause harmful interference to radio communications. Operation of this equipment in a residential area is likely to cause harmful interference in which case the user will be required to correct the interference at his own expense.

To comply with FCC RF exposure requirements MSA ensures that an approved antenna is installed per FCC ID: 7V1316.

PAN1326 is licensed to meet the regulatory requirements of Industry Canada (IC), license: IC: 216Q-1316 PAN1326

This device complies with part 15 of the FCC Rules. Operation is subject to the following conditions: (1) This device may not cause harmful interference, and (2) this device must accept any interference received, including any interference that may cause undesired operation.



### WARNING

This is a class A product in accordance with CISPR 22. In a domestic environment, this product may cause radio interference, in which case the user may be required to take adequate measures.

This Class A digital apparatus complies with Canadian ICES-003.

### Be Aware of the Warranty Regulations

The warranties made by Mine Safety Appliances Company with respect to the product are voided if the product is not used and maintained in accordance with the instructions in this manual. Please protect yourself and others by following them. We encourage our customers to write or call regarding this equipment prior to use or for any additional information relative to use or service.

### Be Aware of the Product Regulations

Follow all relevant national regulations applicable in the country of use.

**Warranty**

ITEM	WARRANTY PERIOD
Chassis and electronics	Three years
XCell COMB, O <sub>2</sub> , H <sub>2</sub> S, CO, SO <sub>2</sub> , NO <sub>2</sub> , and MSA IR sensors	Three years
XCell Cl <sub>2</sub> , NH <sub>3</sub> sensors	Two years
Series 20 ClO <sub>2</sub> , HCN, NO, NO <sub>2</sub> , PH <sub>3</sub> sensors	One year

This warranty does not cover filters, fuses, etc. As the battery pack ages, there will be a reduction in usable device run time. Certain other accessories not specifically listed here may have different warranty periods. This warranty is valid only if the product is maintained and used in accordance with Seller's instructions and/or recommendations.

The Seller shall be released from all obligations under this warranty in the event repairs or modifications are made by persons other than its own or authorized service personnel or if the warranty claim results from physical abuse or misuse of the product. No agent, employee or representative of the Seller has any authority to bind the Seller to any affirmation, representation or warranty concerning this product. Seller makes no warranty concerning components or accessories not manufactured by the Seller, but will pass on to the Purchaser all warranties of manufacturers of such components.

**THIS WARRANTY IS IN LIEU OF ALL OTHER WARRANTIES, EXPRESSED, IMPLIED OR STATUTORY, AND IS STRICTLY LIMITED TO THE TERMS HEREOF. SELLER SPECIFICALLY DISCLAIMS ANY WARRANTY OF MERCHANTABILITY OR OF FITNESS FOR A PARTICULAR PURPOSE.**

**Exclusive Remedy**

It is expressly agreed that Purchaser's sole and exclusive remedy for breach of the above warranty, for any tortious conduct of Seller, or for any other cause of action, shall be the replacement at Seller's option, of any equipment or parts thereof, which after examination by Seller is proven to be defective. Replacement equipment and/or parts will be provided at no cost to Purchaser, F.O.B. Seller's Plant. Failure of Seller to successfully replace any nonconforming equipment or parts shall not cause the remedy established hereby to fail of its essential purpose.

**Exclusion of Consequential Damage**

Purchaser specifically understands and agrees that under no circumstances will seller be liable to purchaser for economic, special, incidental or consequential damages or losses of any kind whatsoever, including but not limited to, loss of anticipated profits and any other loss caused by reason of nonoperation of the goods. This exclusion is applicable to claims for breach of warranty, tortious conduct or any other cause of action against seller.

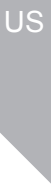

## 2 Description

### 2.1 Overview



Fig. 1 Device view

- |   |  |    |                            |
|---|--|----|----------------------------|
| 1 | LEDs<br>2 red "Alarm", 1 green "Safe" and 1 yellow "Fault" | 8  | IRDA Communication port    |
| 2 | Horn   | 9  | Pump inlet                 |
| 3 | Display  | 10 | RFID tag                   |
| 4 | ▲ Button   | 11 | Filter                     |
| 5 | ⊙ Button   | 12 | Belt Clip (ALTAIR 5X only) |
| 6 | ▼ Button   | 13 | Charging port              |
| 7 | Bluetooth Status LED                                       | 14 | Charge Status LED          |

The device monitors gases in ambient air and in the workplace.

The ALTAIR 5X is available with a maximum of four sensors, which can display readings for five separate gases (one Two-Tox Sensor provides both CO and H<sub>2</sub>S or CO and NO<sub>2</sub> sensing capabilities in a single package).

The ALTAIR 5X IR is available with a maximum of five sensors, which can display readings for six separate gases (one Two-Tox Sensor provides both CO and H<sub>2</sub>S or CO and NO<sub>2</sub> sensing capabilities in a single package).

The ALTAIR 5X and ALTAIR 5X IR Multigas Detectors are available with either a monochrome or color display.

The alarm levels for the individual gases are factory-set and can be changed through the Instrument Setup Menu. These changes can also be made through MSA Link Software. Ensure that the latest version of the MSA Link software has been downloaded from MSA's website [www.msasafety.com](http://www.msasafety.com). It is recommended that after making changes using MSA Link software, the device should be turned OFF and ON.

US only: While the device can detect up to 30 % oxygen in ambient air, it is approved for use only up to 21 % oxygen.

## 2.2 Device Hardware Interfaces

Device operation is dialog driven from the display with the aid of the three function buttons (→ Fig. 1). The device has three buttons for user operation. Each button can function as a "soft key", as defined on the display directly above the button.

### Button Definitions

Button	Description
⏻	The ⏻ button is used to turn the device ON or OFF and to confirm user action selections.
▼	The ▼ button is used to page down through data screens or to decrease the values in setup mode. This button is also used to initiate a Bump Test for the installed sensors, directly from the MEASURING page. If the user is granted access to the MotionAlert setting feature, this button can be used to activate the InstantAlert™ alarm. See chapter 3.5 for the means to allow/disallow user access.
▲	The ▲ button is used to reset Peak, STEL, TWA and alarms (where possible) or perform calibration in measuring mode. It is also used as page up or to increase the values in setup mode.







When the ▲ button and the ▼ button are pressed simultaneously while in normal measure mode, the Setup mode can be entered after the password is confirmed.

### LED Definitions

LED	Description
<b>RED</b> (Alarm)	The red alarm LEDs are visual indications of an alarm condition or any type of error in the device.
<b>GREEN</b> (Safe)	The Safe LED flashes once every 15 seconds to notify the user that the device is ON and operating under the conditions defined below: <ul style="list-style-type: none"> <li>- The green SAFE LED is enabled</li> <li>- Combustible reading is 0 % LEL or 0 % Vol</li> <li>- Oxygen (O<sub>2</sub>) reading is 20.8 %</li> <li>- Carbon Dioxide (CO<sub>2</sub>) reading is ≤ 0.03 %</li> <li>- All other sensor readings are 0 ppm</li> <li>- No gas alarms are present (low or high)</li> <li>- Device is not in Low Battery warning or alarm</li> <li>- STEL and TWA readings are 0 ppm</li> </ul> This option can be turned OFF through the MSA Link software.
<b>YELLOW</b> (Fault)	The Fault LED activates if any of several fault conditions are detected during device operation. This includes: <ul style="list-style-type: none"> <li>- A device memory error</li> <li>- A sensor determined to be missing or inoperative</li> <li>- A pump fault</li> </ul> These faults are also indicated by activation of device alarm LEDs, horn, and vibrating alarm.
<b>BLUE</b> (Bluetooth Status)	The blue LED is a visual indication of the Bluetooth connection status. <ul style="list-style-type: none"> <li>- Off = Bluetooth board OFF or Undiscoverable</li> <li>- Fast Flash = Discoverable Mode</li> <li>- Slow Flash = Connected</li> </ul>

## 2.3 Alarms

The device is equipped with multiple alarms for increased user safety:

Icon	Alarm
	<p><b>Vibrating Alarm</b> The device vibrates when any alarm condition is active. This can be turned OFF through the SETUP- ALARM OPTIONS menu (→ chapter 3.5).</p>
	<p><b>Horn</b> The device is equipped with an audible alarm. The horn can be turned OFF through the SETUP- ALARM OPTIONS menu (→ chapter 3.5).</p>
	<p><b>InstantAlert™ Alarm</b> The InstantAlert exclusive feature allows the user to manually activate an audible alarm to alert those nearby to potentially dangerous situations. Holding the ▼ button for approximately 5 seconds while in Normal Measure Mode activates the InstantAlert alarm. Access to this feature may be restricted. See chapter 3.5 for means to allow/disallow user access.</p>
	<p><b>MotionAlert™ Alarm</b> If MotionAlert is turned ON (see chapter 3.5), the device activates a "Man Down" alarm if motion is not detected within 30 seconds. The Alarm LEDs flash, and the horn activates with an increasing audible frequency. MotionAlert is always turned OFF when the device is turned OFF. Access to this feature may be restricted by user settings. See chapter 3.5 for means to allow/disallow user access.</p>
	<p><b>Stealth Mode</b> Stealth Mode disables the visual, audible and vibrating alarms. MSA recommends that this feature be left in its default "OFF" state. Stealth mode can be turned ON through the SETUP - INSTRUMENT OPTIONS menu (chapter 3.5). The message "Alarms OFF" flashes on the monochrome display when Stealth mode is ON. On the color display, all three alarm icons are shown as OFF.</p>
	<p><b>Sensor Life Alarm</b> The device evaluates the condition of the sensors during Calibration. As the end of a sensor's life approaches, a warning is provided. While the sensor is still fully functional, the warning gives the user time to plan for a replacement sensor to minimize downtime. The Sensor Life indicator ♥ displays during ongoing operations as a reminder of a sensor's pending end of life. When a sensor's end-of-life is reached, sensor calibration will not be successful, and the user is then alerted by a Sensor Life Alarm. A flashing Sensor Life indicator ♥ displays during ongoing operations until the sensor is replaced and/or successfully calibrated. On the monochrome display, the Sensor Life indicator appears on the display at the same position as the MotionAlert indicator. If MotionAlert is enabled (the + indicator displays) and a Sensor Life warning or alarm occurs, the Sensor Life indicator ♥ takes priority and is shown instead. On the color display, each displayed gas will have its own Sensor Life indicator. If a sensor is in end-of-life warning, its indicator will be an orange ♥. If a sensor has reached end-of-life, it is in alarm and its Sensor Life indicator will be a continuous blinking red ♥. See chapter 3.10 for additional details on Sensor Life determination and indication.</p>
	<p><b>Backlight</b> The backlight automatically activates when any front panel button is pressed and remains ON for the duration of user-selected timeout. This duration can be changed using the SETUP - INSTRUMENT SETUP(→ chapter 3.5) or through MSA Link software.</p>

Icon	Alarm
	<p>Operating Beep</p> <p>This operating beep activates every 30 seconds by momentarily beeping the horn and flashing the alarm LEDs under the following conditions:</p> <ul style="list-style-type: none"> <li>- Operating beep is enabled</li> <li>- Device is on normal Measure Gases page</li> <li>- Device is not in battery warning</li> <li>- Device is not in gas alarm.</li> </ul> <p>The Operating Beep can be disabled using the SETUP - INSTRUMENT OPTIONS (→ chapter 3.5) or through MSA Link software.</p>

## 2.4 On-Screen Indicators

### Monochrome Display

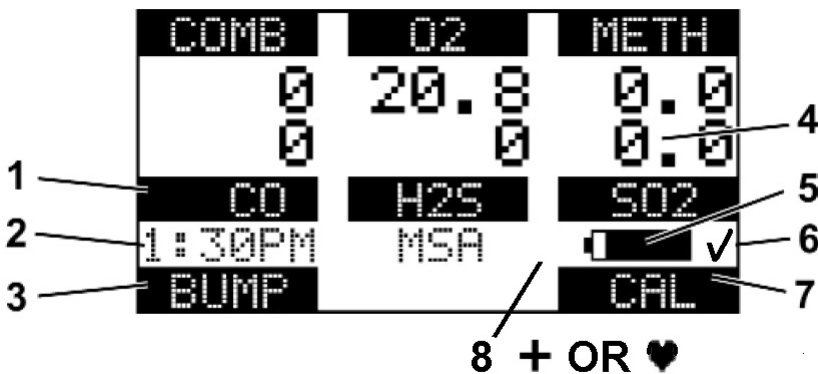





Fig. 2 Monochrome Display

- |                          |   |
|--------------------------|---|
| 1 Gas type               | 5 Battery condition   |
| 2 Current time           | 6 Successful Bump Test/Calibration Indicator  |
| 3 "Soft Key" ▼ Indicator | 7 "Soft Key" ▲ indicator  |
|                          |  MotionAlert (+ = ON)    |
| 4 Gas reading            | 8  Sensor Life Indicator |
|                          |  Bluetooth On/Off        |

On a monochrome display, a message appears every 30 seconds if the Vibration, Horn or LED alarms are turned OFF.

## Color Display

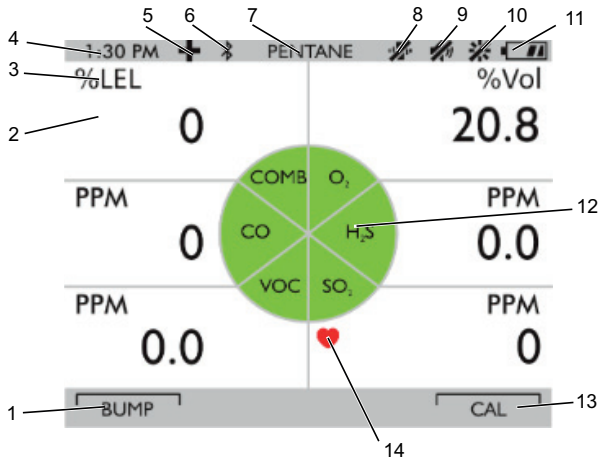

Fig. 3 Color display

1	"Soft Key" ▼ Indicator	8	Vibration alarm OFF
2	Gas reading	9	Horn OFF or successful Bump Test/ Calibration Indicator
3	Gas Concentration Units	10	LED OFF
4	Current Time	11	Battery charge level
5	Motion Alert symbol ON	12	Gas Type
6	or  Wireless USB or Bluetooth ON	13	"Soft Key" ▲ Indicator
7	Combustible Gas/VOC type	14	Sensor Life Indicator

**Battery Charge Level Indicator**

The battery condition icon continuously displays in the upper right-hand corner of the color display and in the lower right-hand corner of the monochrome display. A bar represents the charging level of the battery.

The nominal run-time of the device (COMB, O<sub>2</sub>, CO, H<sub>2</sub>S, with pump and monochrome display) at room temperature is 20 hours. Actual run-time will vary depending on ambient temperature, battery and alarm conditions.

## Low Battery Warning

WARNING

If battery warning alarm activates while using the device, leave the area immediately as the end of battery life is approaching. Failure to follow this warning can result in serious personal injury or death.

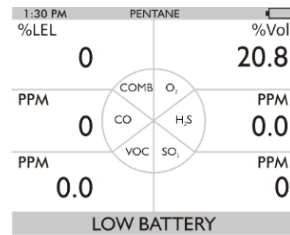
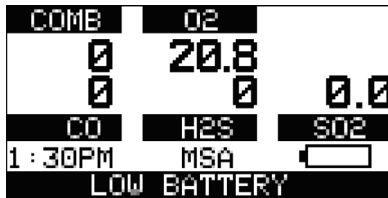

Fig. 4 Battery Warning

The duration of remaining device operation during a Low Battery Warning depends on ambient temperatures, battery condition alarm status. Nominal battery life is 30-60 minutes after the Battery Warning activates.

When the device goes into battery warning the:

- battery life indicator continuously blinks
- alarm sounds and alarm LEDs flash every 30 seconds
- Safe LED no longer flashes
- device continues to operate until it is turned OFF or battery shutdown occurs.



### Battery Shut Down



#### WARNING

If battery alarm displays, stop using the device as it no longer has enough power to indicate potential hazards, and persons relying on this product for their safety could sustain serious personal injury or death.

The device goes into battery shutdown mode 60 seconds before final shutdown (when the batteries can no longer operate the device):

- "BATTERY ALARM" flashes on the display
- Alarm sounds
- Alarm LEDs flash
- Fault LED is on
- No other pages can be viewed; after approximately one minute, the device automatically turns OFF.

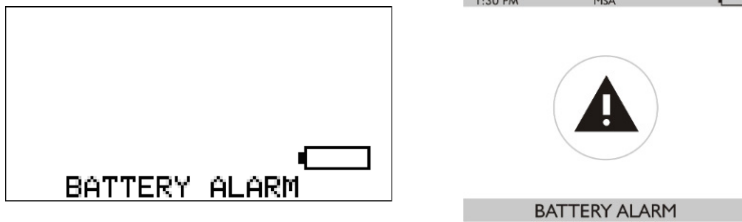

Fig. 5 Battery Shut Down

When battery shutdown condition occurs (shown in Fig. 5):

- (1) Leave the area immediately.
- (2) Recharge or replace the battery pack.

**Battery Charging****WARNING**

Risk of explosion: Do not recharge device in hazardous area.

**NOTICE**

Use of any charger, other than the charger supplied with the device, may damage or improperly charge the batteries.



For users in Australia/ New Zealand: The charge cradle is a Class A product. In a domestic environment, this product may cause radio interference, in which case, the user may be required to take adequate measures.

The charger is capable of charging a completely depleted pack in less than six hours in normal, room-temperature environments.



Allow very hot or cold devices to stabilize for one hour at room temperature before attempting to charge.

- Minimum and maximum ambient temperature to charge the device is 10 °C (50 °F) and 35 °C (95 °F), respectively.
- For best results, charge the device at room temperature 23 °C (73 °F).

**To Charge the Device**

- Firmly insert the charger connector into the charge port on the back of the device.
- An LED in the battery pack is used to indicate on the charge status.  
Red = charging, Green = charged, yellow = fault
- If a problem is detected during charging (LED turns yellow):  
Disconnect the charger momentarily to reset the charge cycle.
- The battery pack may be charged separately from the device.
- During periods of non-use, the charger may remain connected to the device/battery pack.



The charger must be disconnected for the device to operate.

## 2.5 Viewing Additional Pages

The Main Screen appears at device turn-ON.

Additional displays can be viewed by pressing the ▼ button to move to the screen as indicated by the "soft key".

(For the monochromatic display the name of the page is displayed, for the color version it is represented by an icon.)

The sequence of pages are as follows and are described below:

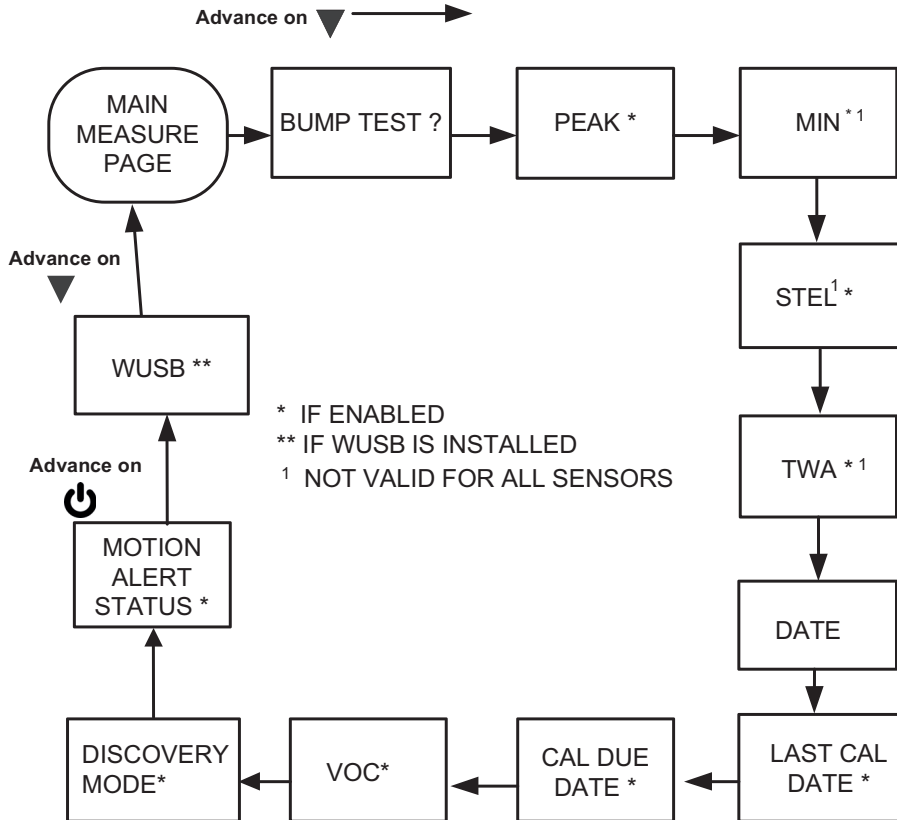

US

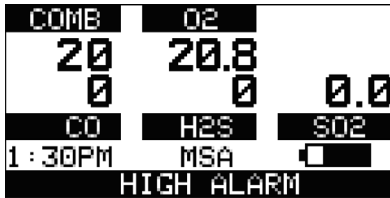
**Bump Test (BUMP page)**

This page allows the user to perform an automated Bump Test on the device. To perform the test, the (YES) button is pressed. See chapter 3.9 for details on performing the Bump Test.

If the ▼ button is pressed, the Bump Test is not performed, and the display shows the next page in the sequence (PEAK).

If the ▲ button is pressed, the Bump Test is not performed, and the display reverts back to the normal MEASURE page.

**Peak Readings (PEAK page)****Monochromatic display****PEAK****Color display**

This page shows the highest levels of gas recorded by the device since turn-ON or since peak readings were reset.

To reset the peak readings:

- (1) Access the PEAK page.
- (2) Press the ▲ button.



This page can be de-activated through MSA Link software.

**Minimum Readings (MIN page)****Monochromatic display****MIN****Color display**

This page shows the lowest level of oxygen recorded by the device since turn-ON or since the MIN reading was reset. It is only shown if an oxygen sensor is installed and enabled.

To reset the MIN reading:

- (1) Access the MIN page.
- (2) Press the ▲ button.

## Short Term Exposure Limits (STEL page)

**WARNING**

If the STEL alarm activates, leave the contaminated area immediately; the ambient gas concentration has reached the preset STEL alarm level. Failure to follow this warning will cause over-exposure to toxic gases and persons relying on this product for their safety could sustain serious personal injury or death.

**Monochromatic display****STEL****Color display**

This page shows the average exposure over a 15-minute period.

When the amount of gas detected by device is greater than the STEL limit:

- Alarm sounds, alarm lights flash.
- Alarm LEDs flash
- "STEL ALARM" message flashes.

To reset the STEL:

- (1) Access the STEL page.
- (2) Press the ▲ button.

The STEL alarm is calculated over a 15-minute exposure.

STEL calculation examples:

Assume the device has been running for at least 15 minutes:

**15 minute exposure of 35 ppm:**

$$\frac{(15 \text{ minutes} \times 35 \text{ ppm})}{15 \text{ minutes}} = 35 \text{ ppm}$$

**10 minute exposure of 35 ppm and 5 minutes exposure of 15 ppm:**

$$\frac{(10 \text{ minutes} \times 35 \text{ ppm}) + (5 \text{ minutes} \times 15 \text{ ppm})}{15 \text{ minutes}} = 25 \text{ ppm}$$



This page can be de-activated through MSA Link software.

## Time Weighted Average (TWA page)

**WARNING**

If the TWA alarm activates, leave the contaminated area immediately; the ambient gas concentration has reached the preset TWA alarm level. Failure to follow this warning will cause over-exposure to toxic gases and persons relying on this product for their safety could sustain serious personal injury or death.

This page shows the average exposure over 8 hours since the device was turned ON or since the TWA reading was reset. When the amount of gas detected is greater than the eight-hour TWA limit:

**Monochromatic display****TWA**

- Alarm sounds
- Alarm LEDs flash
- "TWA ALARM" message flashes.

To reset the TWA Readings:

- (1) Access the TWA page.
- (2) Press the ▲ button.

The TWA alarm is calculated over an eight-hour exposure.

TWA calculation examples:

**1 hour exposure of 50 ppm:**

$$\frac{(1 \text{ hour} \times 50 \text{ ppm}) + (7 \text{ hours} \times 0 \text{ ppm})}{8 \text{ hours}} = 6.25 \text{ ppm}$$

**4 hour exposure of 50 ppm and 4 hour exposure of 100 ppm:**

$$\frac{(4 \text{ hours} \times 50 \text{ ppm}) + (4 \text{ hours} \times 100 \text{ ppm})}{8 \text{ hours}} = 75 \text{ ppm}$$

**12 hour exposure of 100 ppm:**

$$\frac{(12 \text{ hours} \times 100 \text{ ppm})}{8 \text{ hours}} = 150 \text{ ppm}$$



This page can be de-activated through MSA Link software.

**Date Display**

Current date appears on the display in the format: **MM-DD-YY**.

**Last cal page**

Displays the device last successful calibration date in the format: **MM-DD-YY**. This page can be de-activated through MSA Link software or the SETUP - CAL OPTIONS page.

**Cal due page**

Displays the days until the device's next calibration is due (user selectable). This page can be de-activated through MSA Link software or the SETUP - CAL OPTIONS page.

**Discoverable Mode page**

Allows the user to put the device into Bluetooth discoverable mode in order to pair with another device. This page can be deactivated through the SETUP - INSTRUMENT OPTIONS page.

### Motion Alert Activation Page

When the MotionAlert feature is active, the + symbol appears. The device enters pre-alarm when no motion is detected for 20 seconds. This condition can be cleared by moving the device. MotionAlert is turned OFF each time the device is powered OFF. After 30 seconds of no motion, the full MotionAlert alarm is triggered. This alarm can only be cleared by pressing the ▲ button. This page displays if it was selected in Setup Mode. To activate or deactivate the MotionAlert feature, press the ▲ button while the MOTIONALERT ACTIVATION page is displayed.

## 2.6 Sensor Missing Alarm

Enabled IR and XCell sensors are continuously monitored for proper function. If, during operation, the IR or an XCell sensor is detected as failed or disconnected, this alarm message appears.

- "SENSOR MISSING" flashes on the display.
- The problematic sensor is indicated.
- The alarm sounds and the Fault and Alarm LEDs flash.
- The alarm can be silenced by pressing the ▲ button; no other pages can be viewed.

WARNING

When this alarm occurs, the device is inoperative for measuring gases. The user must exit the hazardous area, the device must be powered down, and the sensor situation must be corrected.

## 2.7 Monitoring Toxic Gases

The device can monitor the concentration of a variety of toxic gases in ambient air. Which toxic gases are monitored depends on the installed sensors.

The device displays the gas concentration in parts per million (ppm),  $\mu\text{mol}/\text{mol}$  or  $\text{mg}/\text{m}^3$  on the Measuring page. Gas units are selected in the SETUP - INSTRUMENT OPTIONS page.

WARNING

If an alarm is triggered while using the device, leave the area immediately. Remaining in the area under such circumstances can cause serious personal injury or death.

The device has four gas alarms:

- HIGH Alarm
- LOW Alarm
- STEL Alarm
- TWA Alarm

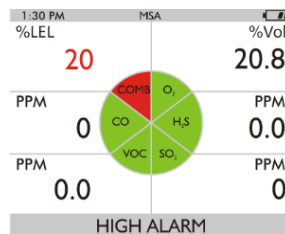
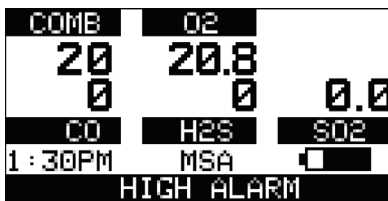

Fig. 6 Alarm Conditions (here High Alarm)

If the gas concentration reaches or exceeds the alarm set point or the STEL or TWA limits, the:

- alarm message displays and flashes in combination with the corresponding gas concentration
- backlight turns on
- alarm sounds (if active)
- alarm LEDs flash (if active)
- vibrating alarm triggers (if active)

## 2.8 Monitoring Oxygen Concentration

The device monitors the oxygen concentration in ambient air. The alarm set points can be configured to activate on two different conditions:

- Enriched - oxygen concentration > 20.8 vol % or
- Deficient - oxygen concentration < 19.5 vol %.



### WARNING

If an alarm is triggered while using the device, leave the area immediately.  
Remaining in the area under such circumstances can cause serious personal injury or death.

When the alarm set point is reached for either of the above conditions:

- the alarm message displays and flashes in combination with the corresponding gas concentration
- backlight turns on
- alarm sounds (if active)
- alarm LEDs flash (if active)
- vibrating alarm triggers (if active)

The LOW alarm (oxygen deficient) is latching and will not automatically reset when the O<sub>2</sub> concentration rises above the LOW set point. To reset the alarm press the ▲ button. If the alarm is latching, the ▲ button silences the alarm for five seconds. Alarms can be made latching or unlatching via MSA Link software.

False oxygen alarms can occur due to changes in barometric pressure (altitude), humidity or extreme changes in ambient temperature.

It is recommended that an oxygen calibration be performed at the temperature and pressure of use. Be sure that the device is in known fresh air before performing a calibration.

## 2.9 Monitoring Combustible Gases

The device can be equipped with a catalytic combustible sensor that detects a variety of combustible gases up to 100 % LEL and displays the reading as either % LEL or % CH<sub>4</sub>. The ALTAIR 5X IR can also contain an IR combustible sensor. The IR sensor displays the reading in % Vol or %LEL.



### WARNING

If an alarm is triggered while using the device, leave the area immediately.  
Remaining in the area under such circumstances can cause serious personal injury or death.

The catalytic combustible, 25 % Vol Butane IR, and 100% LEL Propane IR sensors have two alarm setpoints:

- HIGH Alarm
- LOW Alarm

If the gas concentration reaches or exceeds the alarm set point, the device:

- alarm message displays and flashes in combination with the corresponding gas concentration:
- backlight turns on
- alarm sounds (if active)
- alarm LEDs flash (if active)

The 100 % Vol IR sensors have no alarm setpoints.



**Gas Exposure of 100 % LEL**

When gas reading exceeds 100 % of the lower explosive limit (LEL), the device enters a Lock Alarm state and displays "XXX" in place of the actual reading.

**WARNING**

A catalytic combustible gas reading of "XXX" indicates the atmosphere could be above 100 % LEL or 5.00 % Vol CH<sub>4</sub> and an explosion hazard exists. Move away from contaminated area immediately.

For ALTAIR 5X IR devices with an enabled 100 % Vol methane IR sensor, the LockAlarm will clear, and the catalytic combustible again displays combustible concentrations when the gas sample drops to a lower level. For devices without an enabled 100 % Vol methane IR sensor, the user can clear the LockAlarm state only by turning the device OFF, and then ON again in a fresh air environment. When catalytic combustible gas reading digits appear, the device is available for measuring gases once again.



LockAlarm of the catalytic combustible sensor occurs during Bump Testing and calibration of a % Vol combustible IR sensor.

After the IR sensor Bump Test, the LockAlarm must be cleared (as described above) before the catalytic combustible sensor is again able to measure and provide readings.



Check your national standard values for 100 % LEL.

## 3 Operation

Device operation is dialog driven from the display with the aid of the three function buttons (→ chapter 2.2).

For more information, see the flow charts in chapter 9.

### 3.1 Environmental Factors

A number of environmental factors may affect the gas sensor readings, including changes in pressure, humidity and temperature. Pressure and humidity changes affect the amount of oxygen actually present in the atmosphere.

#### Pressure Changes

If pressure changes rapidly (e.g., stepping through airlock), the oxygen sensor reading may temporarily shift and possibly cause the device to go into alarm. While the percentage of oxygen may remain at or near 20.8 Vol %, the total amount of oxygen present in the atmosphere available for respiration may become a hazard if the overall pressure is reduced by a significant degree.

#### Humidity Changes

If humidity changes by any significant degree (e.g., going from a dry, air conditioned environment to outdoor, moisture laden air), oxygen readings can be reduced by up to 0.5 %, due to water vapor in the air displacing oxygen.

The oxygen sensor has a special filter to reduce the effects of humidity changes on oxygen readings. This effect will not be noticed immediately, but slowly impacts oxygen readings over several hours.

#### Temperature Changes

The sensors have built-in temperature compensation. However, if temperature shifts dramatically, the sensor reading could shift.

## 3.2 Turning ON and Fresh Air Setup

Device operation is dialog driven from the display with the aid of the three function buttons (→ chapter 2.2).

For more information, see the flow charts in chapter 9.

Turn the device ON with the **⏻** button.

The device performs a self test:

During the self test, the device checks alarm LEDs, audible alarm, vibrating alarm and installed sensors.

The device displays:

- Startup logo
- Software version, device serial number, company name, department and user names
- IC / FCC ID Identifier
- Sampling system safety test

During the turn-ON sequence, if a sensor was changed since the previous device operation, the current listing of the installed sensors displays and user interaction is required.

- ▷ The user must accept the new configuration by pressing the **▲** button.
  - ▷ If the current sensor configuration is not accepted, the device alarms and is not usable.
- Combustible gas type, and installed sensor indication
- Combustible gas type and sensor units (monochrome display only)
- Alarm setpoints Low Alarm
- Alarm setpoints High Alarm
- Alarm setpoints STEL Alarm (if enabled)
- Alarm setpoints TWA Alarm (if enabled)
- Settings for calibration cylinder
- Current date
- Last calibration date (if enabled)
- CAL due date. If the calibration due date is enabled, the message "**CAL DUE; X DAYS**" appears on the device display.
  - X = the number of days until a calibration is due, user selectable for 1 to 180 days.
- If the number of days until calibration is due reaches 0, an alert occurs and "**CAL DUE, NOW**" displays.
  - Press the **▲** button to clear the alert
- Sensor warm-up period
- Fresh Air Setup option (if enabled).

The Main Measure Page will appear.

The presence of a **♥** indicator on the display means a sensor is approaching or has reached its end-of-life. See chapter 2.3 for details on the Sensor Life Alarm situation.

Refer to flowchart in chapter 9.1.

### Sampling System Safety Test

Upon startup, an alarm (visual, audible and vibrating) is triggered and the customer is prompted to block the pumps/sampling system of the device within 30 seconds.

When the device detects a pump flow block, it will display a PASS message. The startup sequence will resume.

If the device does not detect a pump flow block, it will display an error message.

The device will shut OFF after the customer acknowledges this message by pressing the **▲** button.

Check your sampling system if this occurs and contact MSA as needed.

Users can check the operation of the sampling system anytime during operation by blocking the sampling system to generate a pump alarm.

**⚠ WARNING**

Do not use the pump, sample line, or probe unless the pump alarm activates when the flow is blocked. Lack of an alarm is an indication that a sample may not be drawn to the sensors, which could cause inaccurate readings.

Failure to follow the above can result in serious personal injury or death.

Never let the end of the sampling line touch or go under any liquid surface. If liquid is drawn into the device, readings will be inaccurate and device could be damaged. We recommend the use of an MSA sample probe containing a special membrane filter, permeable to gas but impermeable to water, to prevent such an occurrence.

**Fresh Air Setup (FAS) at device Turn-ON**

The Fresh Air Setup (FAS) is for automatic ZERO adjustment of the device.

The FAS has limits. If a hazardous level of gas is present, the device ignores the FAS command and the device alarm activates.

The ability to perform an FAS at device turn-ON can be disabled by using MSA Link software.



The Fresh Air Setup is not available for the CO2 sensor.

**⚠ WARNING**

Do not perform the Fresh Air Setup unless you are certain you are in fresh, uncontaminated air; otherwise, inaccurate readings can occur which can falsely indicate that a hazardous atmosphere is safe. If you have any doubts as to the quality of the surrounding air, do not use the Fresh Air Setup feature. Do not use the Fresh Air Setup as a substitute for daily calibration checks. The calibration check is required to verify span accuracy. Failure to follow this warning can result in serious personal injury or death.

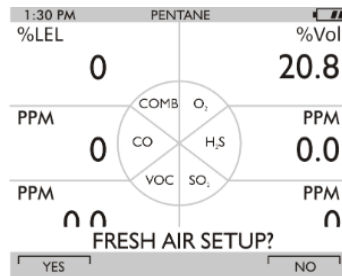
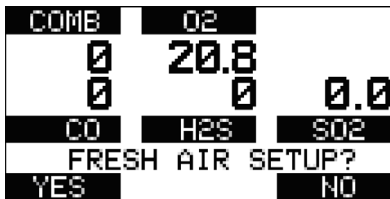

Fig. 7 Fresh Air Setup



The device displays a blinking "FRESH AIR SETUP?", prompting the user to perform a Fresh Air Setup:

- (1) Press the ▲ button to bypass the Fresh Air Setup.
  - ▷ The Fresh Air Setup is skipped and the device goes to the Measuring page (Main page).
- (2) Press the ▼ button to perform the Fresh Air Setup.
  - ▷ The device starts the FAS sequence and the FAS screen displays.
  - ▷ A progress bar shows the user how much of the FAS has been completed.
  - ▷ At the end of the FAS, the device displays either "FRESH AIR SETUP PASS" or "FRESH AIR SETUP FAIL".

If the FAS fails, perform a zero calibration (→ chapter 3.10).

### 3.3 Special Consideration for Oxygen Sensor

Under the following situations, the oxygen sensor display reading may be suppressed for up to 30 minutes at device turn-ON as a sensor 'cook down' is performed.

This could occur if:

- the oxygen sensor was just installed
- the battery pack was allowed to be deep-discharged
- the battery pack was removed from the device.











During this time, the oxygen sensor numeric position on the display indicates "PLEASE WAIT". While this message displays, the device cannot respond to a:

- Fresh Air Setup
- Calibration
- Bump Test procedure.

When the numeric oxygen reading appears, the FAS, calibration, or Bump Test procedures may be performed.

### 3.4 Measurement Mode (Normal Operation)

The following options pages can be executed from the Measurement screen:

<b>BUMP page</b>		This page allows user to perform a Bump Test on installed sensors
<b>Peak Page*</b>		This page shows the peak readings for all sensors.
<b>Min Page</b>		This page shows the minimum readings for the oxygen sensor.
<b>STEL Page*</b>		This page shows the calculated STEL readings of the device.
<b>TWA Page*</b>		This page shows the calculated TWA readings of the device.
<b>Date Page</b>		This page shows actual date settings of the device.
<b>Last Cal Date</b>		This page shows the date of the last calibration.
<b>Cal Due*</b>		This page shows the set date for the next calibration.
<b>Discoverable Mode</b>		This page allows the user to put the instrument into Bluetooth discoverable mode in order to pair with another device.
<b>Motion Alert</b>		This page allows the Motion Alert Feature to be activated or deactivated.
<b>Wireless USB</b>		This page allows the Wireless USB communication to be activated or deactivated.

\* The display of these pages can be de-activated through MSA Link software  
For further information see chapter 10.

### 3.5 Device Setup

The device has provisions to access and modify the following parameters through direct button interface:

- Calibration Options
- Alarm Options
- Instrument Options

These menus can be accessed only from the measure page by pressing and holding the ▼ and ▲ buttons simultaneously until you are prompted for a password.

The operation is as follows:

- (1) Turn the device ON and wait until the measure page appears.
- (2) Simultaneously press and hold the ▼ and ▲ buttons for approximately five seconds.
  - ▷ The default password is "672".

#### PASSWORD



- (3) Enter the first digit by pressing the ▼ or ▲ button and confirm with the Ⓞ button.
  - ▷ The cursor jumps to the second digit.
- (4) Enter the second as well as the third digits.
  - ▷ Incorrect password: device returns to the Main Page.
  - ▷ Correct password: user can enter the Setup mode.

The password can be changed with a PC through the MSA Link software. If the password is forgotten, it can be reset by using MSA Link software. Contact MSA Customer Service for assistance.

The following Options are available by pressing the ▼ and ▲ buttons:

- Calibration Options - see chapter 3.5
- Alarm Options - see chapter 3.5
- Instrument Options - see chapter 3.5

## Calibration Setup

### CALIBRATION OPTIONS



The Calibration Options menu has provisions to:

- modify the calibration cylinder settings (CYLINDER SETUP)
- enable/disable calibration due and to set the number of days (CAL DUE OPTIONS)
- enable/disable the option to show the last cal date at turn on and (LAST CAL DATE)  
When enabled, the date of the last device calibration displays during the turn-ON process.
- enable/disable the option for password protected calibration (CAL PASSWORD)  
When enabled, the device setup password must be entered prior to calibration.

Press:

- the ▼ button go to next page
- the ▲ button to go previous page
- the ⏻ button to enter setup.

#### Setting Calibration Cylinder

This option has a dialog similar to the span calibration dialog.  
The display shows all active sensors.

- (1) Press the ⏻ button to enter setup.
  - ▷ The screen for the first calibration cylinder displays.
- (2) Press
  - ▷ the ▼ or ▲ button to change the value.
  - ▷ the ⏻ button to confirm the setup.

With this confirmation the device automatically moves to the next cylinder setting.

- (3) Repeat the sequence for changing the required settings for all necessary gas values.  
After the last setting is performed, the device returns to the Calibration Options menu.



**Setting Cal Due Options**

- (1) Press the  $\phi$  button to enter setup.
- (2) Press the  $\blacktriangledown$  or  $\blacktriangle$  button to enable/disable this option.
- (3) Press the  $\phi$  button to confirm.
- (4) After confirmation the device prompts the user to enter the number of days for the reminder.
- (5) Change number of days by pressing the  $\blacktriangledown$  or  $\blacktriangle$  button.
- (6) Press the  $\phi$  button to go to the next menu.

**Setting Last Cal Date**

- (1) Press the  $\phi$  button to enable/disable this option.
- (2) Press the  $\blacktriangledown$  button to go to the next page.
- (3) Press the  $\blacktriangle$  button to go to the previous page.

**Setting Calibration Password**

- (1) Press the  $\phi$  button to enable/disable this option.
- (2) Press the  $\blacktriangledown$  button to go to the next page.
- (3) Press the  $\blacktriangle$  button to go to the previous page.

**Back To Main Menu**

- (1) Press the  $\phi$  button to go to Device Setup Menu
  - ▷ The Cal Options screen displays
- (2) Press the  $\blacktriangledown$  button to go to the next (Alarm options) or the  $\blacktriangle$  button to exit the Setup menu.

**Alarm Setup**

**ALARM OPTIONS**



The Alarm Options Menu allows the user to:

- enable/disable the vibrating alarm
- enable/disable the audible alarm (horn)
- enable/disable the Alarm LEDs
- enable/disable the MOTIONALERT SELECTION page.  
If disabled, the user cannot change the device MotionAlert setting.
- set Sensor Alarms.

Press

- the  $\blacktriangledown$  button go to next page
- the  $\blacktriangle$  button to go previous page
- the  $\phi$  button to enter setup.

**Setting Vibrating Alarm**

Press the  $\phi$  button to enable/disable this option.

**Setting Horn Alarm**

Press  $\phi$  button to enable/disable this option.

**Setting LED Alarm**

Press  $\phi$  button to enable/disable this option.



**Setting MotionAlert Access**

Setting this parameter allows the user to access the MOTIONALERT page from the MEASURE page. If access is denied here:

- the user cannot access the MOTIONALERT page to enable or disable that feature
  - the InstantAlert feature (chapter 2.3) cannot be activated.
- (1) To grant or deny user access to the MOTIONALERT page, use the button to change the indicated selection.  
 User access is:
- ▷ permitted when the setting indicates ON.
  - ▷ denied when the setting indicates OFF.
- (2) The selection is confirmed by pressing either the ▼ or ▲ button.

**Setting Sensor Alarms**

This page allows modifying the preset alarm values of:

- LOW Alarm
- HIGH Alarm
- STEL Alarm
- TWA Alarm.



Factory set alarm levels are shown in chapter 5.1.

- (1) Press the Ⓞ button to enter Sensor Alarm setup.  
 ▷ LOW Alarm Setup screen displays.

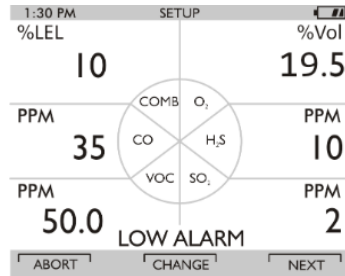
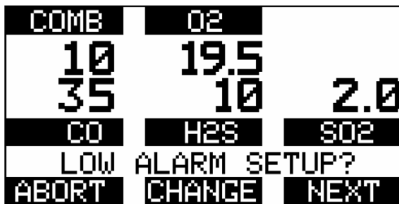

Fig. 8 Sensor Alarm Setup

- (2) Press
- the ▼ button to abort the operation or
  - the ▲ button to go to next alarm setup or
  - the Ⓞ button to change the alarm setpoints.
- ▷ Alarm Value for the first Sensor displays.

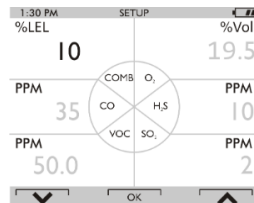

Fig. 9 Sensor Alarm Setup

- (3) Set values for Sensor Alarm by pressing the ▼ or ▲ button.
- (4) Press the ⏻ button to confirm set value.
- (5) Repeat setting for all other sensors.
- (6) Press the ▲ button to return to the Alarm Options menu.
- (7) Repeat setting for all other alarm types.

### Instrument Options

#### SETTINGS



The Instrument Options menu allows modification of different device options:

- Sensor Setup (enable/disable the channel)
- Language Setup
- Time Date Setup
- Datalog Intervals
- Stealth Mode
- Operating Beep
- Display Contrast (monochrome only)
- Backlight Options
- Bluetooth

Press

- the ▼ button go to next page
- the ▲ button to go previous page
- the ⏻ button to enter setup.

#### Setting Sensor Options

- (1) Press the ⏻ button to enter setup.
  - ▷ Following screen displays:

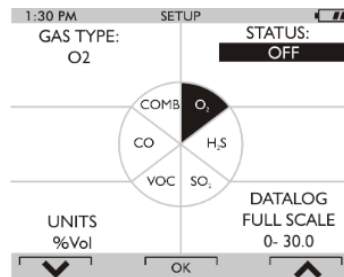
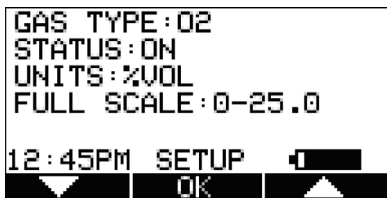

Fig. 10 Sensor Options Setup

- (2) Press the ▼ button to select sensor, press the ⏻ button to make changes.
  - ▷ The sensor information is displayed and the sensor can be enabled or disabled.



Other operations such as changing the gas type (Methane, Butane, Propane etc. for the combustible sensor) and units (ppm to mg/m3) are only possible using the MSA Link software.

- (3) Change status by pressing the ▼ or ▲ button.
- (4) Press the ⏻ button to confirm and advance to next screen (next sensor).
- (5) Perform the sequence for all other sensors.
  - ▷ After setting up the last sensor the device goes to the next Setup Page.

### Language Setup

This option is for setting the language of the device.

- (1) Press the ⏻ button to enter setup.
- (2) Change language by pressing the ▼ or ▲ button.
- (3) Confirm with the ⏻ button.
  - ▷ The device goes to the next Setup Page.

### Time and Date Setup

This option is for setting the device time and date. The device first prompts to set the time and then it prompts for the date.



The time can be set up for either regular AM/PM or military time (through MSA Link software). AM/PM time is the default setting.

- (1) Press the ⏻ button to enter setup.
- (2) Change hours by pressing the ▼ or ▲ button.
- (3) Confirm with the ⏻ button.
- (4) Change minutes by pressing the ▼ or ▲ button.
- (5) Confirm with the ⏻ button.
  - ▷ The device goes to the Set Date Page.
- (6) Change month, date and year by pressing the ▼ or ▲ button and confirming with the ⏻ button.
  - ▷ The device goes to the next Setup Page.
- (7) Confirm with the ⏻ button.
  - ▷ The device goes to the next Setup Page.

### Setting Datalog Intervals

This option is for setting the intervals at which all the readings will be logged.

- (1) Press the ⏻ button to enter setup.
- (2) Change interval by pressing the ▼ or ▲ button.
- (3) Confirm with the ⏻ button.
  - ▷ The device goes to the next Setup Page.

### Setting Stealth Mode

Stealth mode disables the visual, audible and vibrating alarms.

- (1) Press the ⏻ button to change mode (ON/OFF).
- (2) Press the ▼ button to go to the next page or the ▲ button to return to previous page.

### Setting Operating Beep

- (1) Press the ⏻ button to change mode (ON/OFF).
- (2) Press the ▼ button to go to the next page or the ▲ button to return to previous page.

**Setting Display Contrast (monochrome display)**

- (1) Press ▼ or ▲ button to adjust the contrast level.
- (2) Press ⏻ button to confirm the contrast level.

**Setting Backlight**

- (1) Press the ⏻ button to enter setup.
  - ▷ Change option by pressing the ▼ or ▲ button.
- (2) Press the ⏻ button to enter.
- (3) Change timeout by pressing the ▼ or ▲ button.
- (4) Press ⏻ button to confirm timeout.

**Setting Bluetooth**

- (1) Press the ⏻ button to change mode (ON/OFF).
- (2) Press the ▼ button to go to the next page or the ▲ button to return to previous page.

**Back To Main Menu**

There are three options at this point:

the ▼ button	Sensor Options menu
the ▲ button	Previous Setup page in the Instrument Options menu
the ⏻ button	Instrument Options menu

**3.6 Bluetooth Operation**

Bluetooth must be enabled for any Bluetooth functions to operate. See chapter 3.5. Compatible Bluetooth host with appropriate software is required for proper operation.

**Bluetooth security**

The Bluetooth connection is encrypted and secured with a unique six digit pin that must be double confirmed on both device and Bluetooth host at the time of pairing.

**Discovery Mode**

This device mode is used to enable a Bluetooth host to pair with the device for the first time or if a different Bluetooth host was connected with the device previously.



Note that the device will automatically enter discovery mode for five minutes at device turn on if Bluetooth has been enabled. Discovery mode will also be entered for 5 minutes following a disconnection.

To manually enter discovery mode:

- (1) Page down through the menu pages in Measurement Mode using the ▼ button until the Discovery Mode page is displayed.
- (2) Press the ⏻ button to enter discovery mode.
  - ▷ The blue led will blink rapidly indicating that the device is in Discovery Mode.

**Connecting the device to a Bluetooth host for the first time**

- (1) Ensure that the device is on and in Discovery Mode
- (2) On the Bluetooth host, locate the Bluetooth device list. Select "A5X-xxxxxxx" from the list.
  - ▷ Both the device and Bluetooth host will display a unique six digit security code to ensure that the correct devices are being paired.
- (3) After confirming that the six digit codes match, confirm the pairing request on the device by pressing the ▼ button.
- (4) Confirm on the Bluetooth host as well.

**Connecting the device to a Bluetooth host**

If this was the last device connected to the Bluetooth host, the Bluetooth host can connect to the device whether or not the device is in discovery mode as long as Bluetooth is enabled. The six digit code confirmation will not be displayed.



The device will only recall the last Bluetooth host it was paired with. If connecting to another Bluetooth host, the device must be placed into discovery mode to be detected.

#### **Bump pairing the device to a Bluetooth host**

This device has an integrated RFID chip to facilitate a faster Bluetooth pairing process with a Bluetooth host that supports a RFID or NFC reader with appropriate software. Simply align the RFID or NFC reader of the Bluetooth host directly over the MSA logo on the front of the device. The device and Bluetooth host should become paired and connected.

#### **Disconnecting the device from a Bluetooth host**

The device does not have a disconnect feature as this would be initiated by the Bluetooth host. Use the Bluetooth host functions to purposefully disconnect the device from the Bluetooth host.

#### **Device configuration over Bluetooth connection**

The device has the ability to receive updates to device settings over the Bluetooth connection. The user must successfully pair the device and Bluetooth host confirming that the six digit security code matches both on the device and the Bluetooth host. After a configuration change has been initiated, the user must confirm the request on the device by pressing the ▲ button.

#### **Evacuation alert over Bluetooth connection**

The device has the ability to receive an evacuate message over the Bluetooth connection. The user must successfully pair the device and Bluetooth host confirming that the six digit security code matches both on the device and the Bluetooth host. Once connected, an evacuate message sent to the device will send the device into alarm while displaying EVACUATE on the display. Press the ▲ button to silence the Evacuation alert and confirm the alert was received. Press the ▲ button a second time to reset the Evacuation alert once in a safe area.

### **3.7 MSA Link Operation**

#### **Connecting device to PC**

- (1) Switch ON the device and align the Datalink Communication port on the device to the IR interface of the PC.
- (2) Start the MSA Link software on the PC and start the connection by clicking the connect icon.

### **3.8 Function Tests on the Device**

#### **Alarm Test**

- Turn ON the device.

The user should verify that:

- alarm LEDs flash
- horn sounds briefly
- vibrating alarm triggers briefly.

3.9 Bump Test



**WARNING**

Perform a Bump Test before each day's use to verify proper device operation. Failure to perform this test can result in serious personal injury or death.



Bump test frequency is often stipulated by national or corporate regulations; however, bump testing before each day's use is generally the accepted best safety practice and is therefore MSA's recommendation.

This test quickly confirms that the gas sensors are functioning. Perform a full calibration periodically to ensure accuracy and immediately if the device fails the Bump Test. The Bump Test can be performed using the procedure below or automatically using the GALAXY or GALAXY GX2 Test Stand.

CSA requires (per 22.2 NO. 152) that combustible sensor sensitivity be tested before each day's use on a known concentration of methane equivalent to 25 to 50 % of full scale concentration. ACCURACY MUST BE WITHIN 0 to +20 % OF ACTUAL. Correct accuracy by performing the calibration procedure described in chapter 3.10.

NOTE: The Automated Test Stands cannot test the following sensors:

GALAXY	GALAXY GX2
Chlorine Dioxide	Chlorine Dioxide
% Vol Butane	% Vol Butane
% Vol Propane	% Vol Propane
% Vol Methane	

For these sensors, use this Bump Test procedure.

**Equipment**

See accessory chapter for ordering information for these components.

- Calibration Check Gas Cylinder(s)  
See chapter 5.3 for calibration gas target values and appropriate MSA calibration gas cylinders.
- Demand Flow Regulator(s)
- Tubing appropriate for the gases to be tested
- Kits containing tubing and regulators suitable for reactive and non-reactive gases are available from MSA.



### Performing a Bump Test

For ALTAIR 5X IR devices with combustible % Vol IR sensors, the following gas levels should not be exceeded when used for daily Bump Tests:

- IR Butane 25 % Vol - 8 % Vol Butane Cal Check gas
  - IR Propane 100 % Vol - 50 % Propane Cal Check gas
  - IR Methane 100 % Vol - 20 % Methane Cal Check gas.
  - IR Propane 100% LEL
- (1) While the device is turned ON in a clean, fresh air environment, verify that readings indicate no gas is present.
  - (2) From the normal measure screen press the ▼ button to display "BUMP TEST?".
  - (3) Verify the gas concentrations displayed match the Calibration Check Gas Cylinder. If they do not, adjust the values through the Calibration Setup menu.
    - ▷ Depending on the sensors installed, there could be one to five separate Bump Tests performed, each with a different cylinder, regulator, and tubing used.
  - (4) Attach the demand regulator (supplied in the calibration kit) to the cylinder providing the indicated gases.
  - (5) Connect tubing (supplied in the calibration kit) to the regulator.
  - (6) Attach the other end of tubing to the device pump inlet.
  - (7) Press the ⓪ button to start the bump test:
    - ▷ the progress bar advances
    - ▷ the sensors respond to the gas.

The message BUMP TEST PASS indicates a successful Bump Test of the sensors.

If any sensor fails the Bump Test:

- the message BUMP TEST FAIL appears
- the failed sensor is indicated.

If there are more sensors to be Bump Tested, the next sensor displays and the process repeats from Step 4.

If there are no more sensors to be Bump Tested, the tubing can be removed from the device pump inlet.

In the ALTAIR 5X IR, Bump Testing of a combustible IR sensor causes the catalytic combustible sensor to enter the LockAlarm condition. While a device with a % Vol methane IR sensor automatically recovers from LockAlarm, propane or butane IR devices do not. For these devices, clear the LockAlarm state by turning the device OFF, then ON while in a fresh air environment. See chapter 2.9 for additional details.

### After the Bump Test

After all installed sensors pass the Bump Test, the √ symbol displays on the MEASURE page. This √ symbol appears on the:

- color display in the upper feature bar
- monochrome display in the lower-right corner.

If any sensor was not bump tested, or fails the Bump Test, the √ symbol does not display.

The color display:

- temporarily shows the √ symbol at each gas reading for successfully bump tested sensors
- √ symbol is then replaced by the present gas reading.

The monochrome display does not show √ symbols for individual gas readings.

The √ symbol shows for 24 hours after the Bump Test.

If a sensor fails the Bump Test, calibrate the device as described in chapter 3.10.



### 3.10 Calibration

The ALTAIR 5X can be calibrated either manually using this procedure or automatically using the GALAXY or GALAXY GX2 test stand. Refer to chapter 9.5.

The use of the demand regulators listed in chapter 8 is recommended. If a new sensor has been installed, the battery pack has been depleted or a new battery pack has been installed allow sensors to stabilize for 30 minutes before calibration is performed.



#### WARNING

Special conditions with toxic gases!

If the device is to be checked or calibrated for reactive gases, prerequisites are required; otherwise, incorrect calibration would result in incorrect device operation.

Reactive toxic gases (e.g., chlorine, ammonia, chlorine dioxide) have the property of diffusing into the rubber and plastic tubes so that the volume of test gas available in the device would no longer be sufficient to correctly perform device calibration.

When calibrating the device with toxic gases, certain prerequisites are required, otherwise incorrect calibration could result:

- A special pressure regulator
- Shortest possible connection tubes between the pressure regulator and the device
- Connection tubes made from a material that does not absorb the test gases (e.g., PTFE).

NOTE: If using normal tubes and pressure regulators, expose them to the required test gas for an extended time period. Keep these materials dedicated for use with that test gas only; do not use them for other gases.

For example, for chlorine, allow the entire contents of a test gas cylinder to flow through the pressure regulator and tubes before using to calibrate the device. Mark these materials for use with chlorine only.

### Zero Calibration

- (1) Press the ▲ button for five seconds in Normal Measurement page.
  - ▷ ZERO screen displays.

To skip the ZERO procedure and move directly to the span calibration procedure, push the ▲ button. If no button is pushed for 30 seconds, the device prompts user to perform a SPAN calibration before device returns to the Normal Measurement page.

To perform ONLY a Fresh Air Setup at this time, press the ◊ button. The device then performs a Fresh Air Setup as described in chapter 3.2. When the Fresh Air Setup is complete, the device returns to the normal Measure screen.

- (2) Press the ▼ button to confirm the ZERO screen, i. e. to execute zero calibration.
  - ▷ The message "SENSOR REFRESH" displays, followed by the message "ZERO CALIBRATION".
  - ▷ The "REFRESH" message does not appear if a catalytic combustible sensor is not installed.
  - ▷ ZERO calibration starts.
  - ▷ A progress bar shows the user how much of the calibration has been completed.

During the first moments of a ZERO calibration, the combustible sensor reading may be replaced by a moving display of "PLEASE WAIT". This is normal.

- ▷ After the ZERO calibration is completed the device displays either "ZERO CALIBRATION PASS" or "ZERO CALIBRATION FAIL".

- ▷ Only if the device passes the zero calibration the SPAN screen displays.

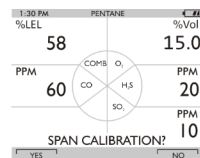
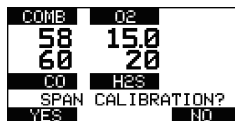
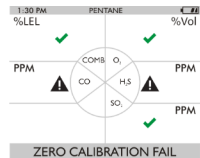
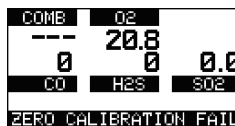
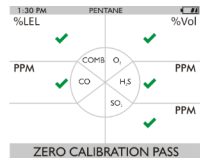
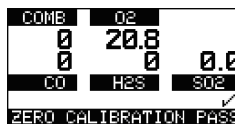
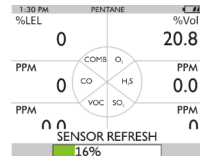
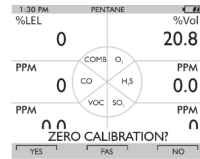
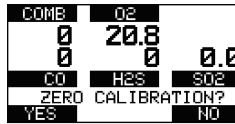

US

### Span Calibration

To skip the Span calibration procedure, push the ▲ button.



If the SPAN calibration of the combustible sensor is skipped after a successful ZERO calibration, the combustible sensor reading may be replaced with a moving display of "PLEASE WAIT" for a few moments. This is normal, and the device is fully operational once a combustible gas reading reappears.

If no button is pushed for 30 seconds, span calibration is skipped.

Because of the different possible combinations of gases that are possible, skipping a Span calibration could advance the user to the Span calibration of another installed sensor, or back to Measuring mode. When calibrating with combustible gases > 100 % LEL, select the "Yes" option to prompt "Span Calibration?" BEFORE applying gas to the device.

- (1) Connect one end of tubing to the cylinder regulator (supplied in the calibration kit).
- (2) Connect the other end of the tubing to the pump inlet.
- (3) Press the ▼ button to calibrate (span) the device.

- ▷ "SPAN CALIBRATION" flashes
- ▷ SPAN calibration starts.
- ▷ A progress bar shows the user how much of the calibration has already been completed.

- ▷ After the SPAN calibration is completed, the device displays either

"SPAN CALIBRATION PASS"

or

"SPAN CALIBRATION FAIL"

- ▷ The device returns to Measuring mode.

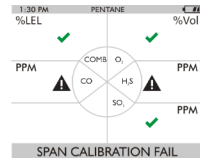
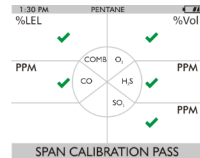
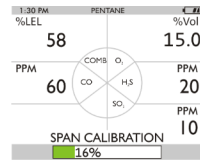
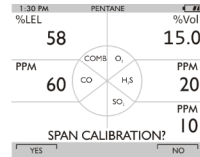
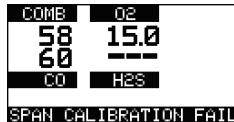
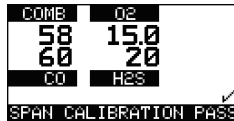
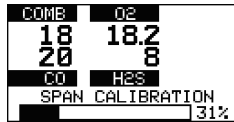
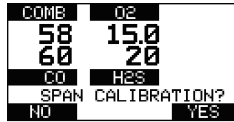

If a sensor is nearing its end-of-life, the "PASS" display is followed by the Sensor Life indicator ♥ display.

- While the sensor is still fully functional, this warning gives the user time to plan for a replacement sensor to minimize downtime.
- The ♥ indicator blinks as the device returns to Measure mode.
- After 15 seconds, the blinking stops, but the ♥ indicator continues to display during ongoing operations as a reminder of a sensor's pending end-of-life.

If a span calibration fails:

- The Sensor Life Indicator ♥ blinks to show a sensor has reached its end-of-life and should be replaced.
- The device remains in the Sensor Life alarm condition until the ▲ button is pressed.
- After the alarm is cleared, the device enters Measure mode and the Sensor Life indicator ♥ blinks during ongoing operations until the sensor is replaced and/or successfully calibrated.

Span calibration can fail for reasons other than a sensor at the end of its life. If a span calibration failure occurs, verify items such as:

- sufficient gas remaining in the calibration cylinder
  - gas expiration date
  - integrity of calibration tubing/fittings, etc.
- Reattempt the span calibration before replacing the sensor.

### Finishing Successful Calibration

(1) Remove the calibration tube from pump inlet.

The calibration procedure adjusts the span value for any sensor that passes the calibration test.

Sensors that fail calibration are left unchanged.

In the ALTAIR 5X IR, a combustible IR sensor calibration causes the catalytic combustible sensor to enter the LockAlarm condition.

- While a device with a % Vol methane IR sensor automatically recovers from LockAlarm, propane and butane IR devices do not; for these devices, the LockAlarm state is cleared by turning the device OFF, then ON while in a fresh air environment (→ chapter 3.2 for details)

On the color display, each successfully calibrated sensor temporarily shows a √ symbol at its gas reading.

These √ symbols remain visible for a few moments and are then replaced by the present gas reading.

The monochrome display does not show √ symbols for individual gas readings.

Since residual gas may be present, the device may briefly go into an exposure alarm after the calibration sequence is completed.

- Press the ▲ button to reset the alarm as necessary.

A √ symbol displays on the MEASURE page. This √ symbol appears on the:

- color display in the upper feature bar
- monochrome display in the lower-right corner.

The √ symbol displays for 24 hours after the calibration and then turns off.



If the horn alarm is turned OFF, the calibration √ symbol does not appear on the color display.

**Calibration with an Automated Test System**

The device can be calibrated using the GALAXY or GALAXY GX2 Automated Test System - contact MSA for a list of compatible gases and concentrations.

Similar to the successful (manual) calibration described in chapter 3.10, a ✓ symbol displays on the MEASURE page after successful GALAXY or GALAXY GX2 calibration.

This ✓ symbol appears on the:

- color display in the upper feature bar
- monochrome display in the lower-right corner.

The ✓ symbol displays for 24 hours after the calibration and then turns off.



If the horn alarm is turned OFF, the calibration ✓ symbol does not appear on the color display.

**3.11 Time of Day Testing**

This feature permits the device to be automatically calibrated on a user-defined interval. The most common use of this feature allows the user to configure the ALTAIR 5X and the GALAXY GX2 System to automatically calibrate a device prior to the start of work-shift. See the GALAXY GX2 Operating Manual ("Automated Testing Features" section) for a complete description of how to configure the GALAXY GX2 for this mode.

On ALTAIR 5X devices with firmware version 1.30 or higher, the following settings must be configured using either MSA Link or the GALAXY GX2 → Instrument Setup page:

- Calibration Due must be enabled and a non-zero Calibration Interval must be entered for automatic calibration testing
- Bump Due must be enabled and a non-zero Bump Interval must be entered for automatic bump testing

The firmware version is displayed on instrument startup. Carefully follow all GALAXY GX2 set-up directions as described in the GALAXY GX2 Operating Manual for proper setup.

**3.12 Device Shutdown**

For device shutdown press and hold the ⏻ button.

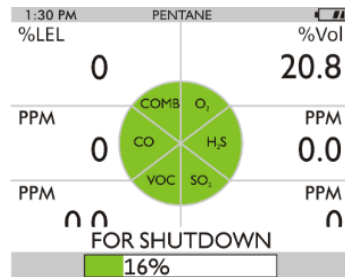



Fig. 11 Shutdown

The device displays a blinking "HOLD BUTTON FOR SHUTDOWN" and a progress bar shows the user how much longer to hold the button to complete the shutdown.

## 4 Maintenance

If irregularities occur during operation, use the displayed error codes and messages to determine appropriate next steps.





WARNING

Repair or alteration of the device beyond the procedures described in this manual or by anyone other than a person authorized by MSA, could cause the unit to fail to perform properly. Use only genuine MSA replacement parts when performing any maintenance procedures described in this manual. Substitution or incorrect installation of components can seriously impair performance of the unit, alter intrinsic safety characteristics or void agency approvals. Failure to follow this warning can result in serious personal injury or death.



Refer to EN 60079-29-2 (Guide for the selection, installation, use and maintenance of apparatus for the detection and measurement of combustible gases or oxygen) and EN 45544-4 (Guide for the selection, installation, use and maintenance of electrical apparatus used for the direct detection and direct concentration measurement of toxic gases and vapors).

### 4.1 Troubleshooting

Error State	Details	Recommended Action
<b>Alternating display</b>		
ADC ERROR	Analogue measurement error	Contact MSA
MEM ERROR	Memory error	Contact MSA
PROG ERROR	Program error	Contact MSA
RAM ERROR	RAM error	Contact MSA
BT ERROR	Bluetooth error	Contact MSA
LOW BATTERY		
 (flashing)	Battery Warning repeats every 30 seconds	Remove from service as soon as possible and recharge or replace battery
BATTERY ALARM	Battery is completely discharged	Device is no longer sensing gas; Remove from service and recharge or replace battery.
Device does not turn ON	Battery fully discharged	Remove from service as soon as possible and recharge or replace battery pack.
SENSOR MISSING	Sensor damaged or missing	Replace sensor
NO SENSORS	No sensors are enabled	Device must have at least one sensor enabled at all times
	Sensor warning	Sensor is near the end of its life
 (flashing)	Sensor alarm	Sensor has reached the end of its life and cannot be calibrated. Replace sensor and recalibrate.
PUMP ERROR	Pump malfunction or flow path blockage	Check flowpath for blockage. If error persists, remove from service.
INVALID CONFIGURATION	Sensor(s) installed in incorrect location.	Install sensors as shown in Figure 14.

US

## 4.2 Verifying Pump Operation

Users can check operation of the sampling system any time during operation by blocking the sampling system to generate a pump alarm.

When the pump inlet, sample line or probe is blocked, the pump alarm must activate.

Once gas readings are displayed, plug the free end of the sampling line or probe.

- The pump motor shuts down and an alarm sounds.
- PUMP ERROR will flash on the display.
- Press the ▲ button to reset the alarm and restart the pump.

If the alarm does not activate:

- Check the sample line and probe for leaks.
- Once leak is fixed, recheck pump alarm by blocking the flow.
- Press the ▲ button to reset the alarm and restart the pump.



### WARNING

Do not use the device, sample line, or probe unless the pump alarm activates when the flow is blocked. Lack of an alarm is an indication that a sample may not be drawn to the sensors, which could cause inaccurate readings. If a sample line or probe is installed and the pump alarm does not activate, remove the line or probe and repeat the test. This will provide information on where the blockage is located.

Failure to follow the above can result in serious personal injury or death.

Never let the end of the sampling line touch or go under any liquid surface. If liquid is drawn into the device, readings will be inaccurate and device could be damaged. We recommend the use of an MSA sample probe containing a special membrane filter, permeable to gas but impermeable to water, to prevent such an occurrence.

During operation, a pump alarm may occur when the:

- Flow system is blocked
- Pump is inoperative
- Sample lines are attached or removed.

### To Clear Pump Alarm

- (1) Correct any flow blockage.
- (2) Press the ▲ button.
  - ▷ The Pump will now restart.

### 4.3 Replacing the Battery

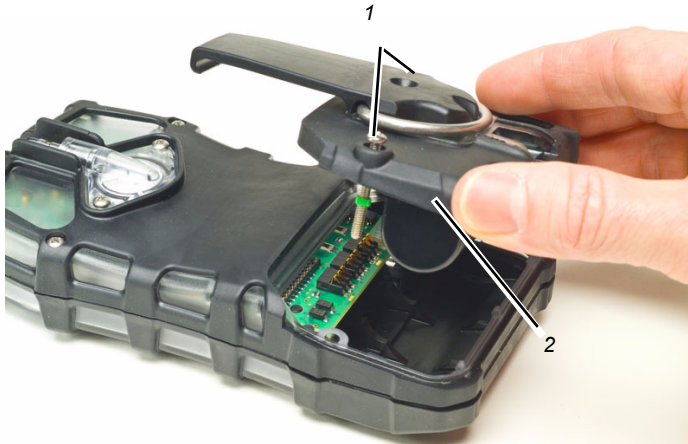

Fig. 12 Battery Replacement

1 Captive screw

2 Battery pack

- (1) Unscrew the two captive screws on the rear of the device.
- (2) Pull the battery pack out of the device by gripping the sides and lifting it up and away from the device.



Fig. 13 Battery Replacement

1 Battery holder

- (3) For alkaline battery packs (ALTAIR 5X only):
  - ▷ Remove the battery holder circuit board from the pack door.
  - ▷ Replace the 3 cells, using only those listed on the label.
  - ▷ Be sure to observe proper polarity on the cells.
  - ▷ Place the battery holder circuit board back in the device and reinstall the door.
- (4) When replacing the battery, be sure to accurately align screws and battery with housing.
- (5) Screws should be tightened and torqued to 5.5 in lb.



#### 4.4 Maintenance Procedure - Replacing or Adding a Sensor

Any factory-installed Series 20 sensor may be removed or replaced with a like type. Any XCell sensor may be removed or replaced according to the positions allowed in table below Figure 1414.

If the type of any sensor (including the IR sensor) is to be changed, the device must be returned to an authorized service center.

**NOTICE**

Before handling the PC board, ensure you are properly grounded; otherwise, static charges from your body could damage the electronics. Such damage is not covered by the warranty. Grounding straps and kits are available from electronics suppliers.



**WARNING**

Remove and reinstall sensors carefully, ensuring that the components are not damaged; otherwise device intrinsic safety may be adversely affected, wrong readings could occur, and persons relying on this product for their safety could sustain serious personal injury or death.



While device case is open, do not touch any internal components with metallic/conductive objects or tools. Damage to the device can occur.

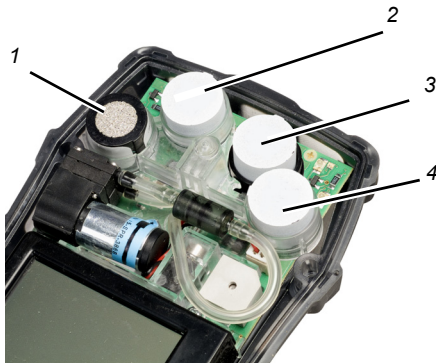

Fig. 14 Possible positions for sensor replacement

- |   |                                       |   |  |
|---|---------------------------------------|---|--|
| 1 | Combustible sensor                    | 3 | NH <sub>3</sub> , CL <sub>2</sub> , H <sub>2</sub> S, SO <sub>2</sub> sensor (position with adapter) or Series 20 sensor |
| 2 | O <sub>2</sub> sensor, Two-Tox sensor | 4 | NH <sub>3</sub> , CL <sub>2</sub> , SO <sub>2</sub> , CO-HC sensor, Two-Tox sensor                                       |

SENSOR	OPERATIONAL ONLY IN POSITION
XCell combustable sensor	1
XCell O <sub>2</sub> sensor	2
XCell Two-Tox sensor	2 or 4
XCell SO <sub>2</sub> , CL <sub>2</sub> , NH <sub>3</sub>	3 or 4
XCell CO-HC	4
Series 20 sensor	3

- (1) Verify that the device is turned OFF.

- (2) Remove the battery pack.
  - (3) Remove the two remaining case screws, and remove the case front.
  - (4) Gently remove the sensor to be replaced.
  - (5) Carefully align the new sensor contact pins with the sockets on the printed circuit board.
  - (6) Press the new sensor into place.
  - (7) Note the position restrictions in the table above.
    - ▷ Adapter (part no. 10110183) is required for XCell usage in position 3.
    - ▷ If a sensor is removed and will not be replaced, be sure to install a sensor plug in its place in order to maintain correct device function.
    - ▷ The plug for XCell positions is P/N 10105650.
    - ▷ The Series 20 plug is P/N 10088192.
  - (8) Reinstall the sensor gasket in the case front.
  - (9) Attach front case and tighten two case screws using 5.5 in-lbs of torque.
  - (10) Attach the battery pack and tighten the two battery pack screws using 5.5 in-lbs of torque.
- If a change in XCell Sensor configuration is detected during the device turn-ON process:
- The "ACCEPT?" prompt appears on the display
  - The ▼ button accepts the sensor configuration
  - The ▲ button rejects the sensor configuration; the device is not operational.
- When an XCell sensor is replaced, the device automatically enables the sensor after the change has been accepted. If a Series 20 sensor is replaced, it must be manually enabled (→ chapter 3.5 SETTING SENSOR OPTIONS).
- If the oxygen sensor was replaced, see chapter 3.2 regarding the oxygen reading display.
- (11) Allow sensors to stabilize at least 30 minutes before calibration.
  - (12) Calibrate device before use.

**WARNING**

Calibration is required after a sensor is installed; otherwise, the device will not perform as expected and persons relying on this product for their safety could sustain serious personal injury or death.

#### 4.5 Replacing the Pump Filter

- (1) Turn OFF the device.
- (2) Unscrew the two captive screws from the clear filter cover on the back of the device to access the filter.
- (3) Carefully lift out the O-ring and the filter disk(s).
- (4) Use both the paper-like filter and the fibrous dust filter (the thicker disk) as supplied in Maintenance Kit if the device is NOT configured to use a reactive toxic gas sensor (does not have a Cl<sub>2</sub>, ClO<sub>2</sub>, or NH<sub>3</sub> sensor).  
Use ONLY the paper filter supplied in the Reactive Gas Maintenance Kit if the device IS configured to use a reactive toxic gas sensor (Cl<sub>2</sub>, ClO<sub>2</sub>, or NH<sub>3</sub>).
- (5) Place the new paper-like filter into the recess in the back of the device. If it is to be used, place the fibrous dust filter into the clear filter cover.



#### WARNING

Use of the fibrous dust filter or the incorrect paper filter for the measurement of reactive gases could cause erroneous readings.

- (6) Replace the O-ring in the recess.
- (7) Re-install the clear filter cover on the back of the device.

#### 4.6 Cleaning the Device Exterior

Clean the exterior of the device regularly using only a damp cloth. Do not use cleaning agents as many contain silicones which will damage the combustible sensor.

#### 4.7 Storage

When not in use, store the device in a safe, dry place between 18 °C (65 °F) and 30 °C (86 °F). After storage, always recheck device calibration before use. If not to be used in 30 days remove battery pack or connect it to a charger.

#### 4.8 Shipment

Pack the device in its original shipping container with suitable padding. If the original container is unavailable, an equivalent container may be substituted.

## 5 Technical Specifications

<b>Weight</b>	0.45 kg (1 lb.) - device with battery and clip (ALTAIR 5X unit)
<b>Weight (with IR Sensor)</b>	0.52 kg (1.15 lb.)
<b>Dimensions (cm)</b>	17 x 8.87 x 4.55 (6.69" H x 3.49" W x 1.79" D) pumped, without belt clip (ALTAIR 5X unit)
<b>Dimensions (cm) (with IR Sensor)</b>	17 x 8.94 x 4.88 (6.68" H x 3.52" W x 1.92" D)
<b>Alarms</b>	LEDs, audible alarm, vibrating alarm
<b>Volume of audible alarm</b>	95 dB typical
<b>Displays</b>	Monochrome / Color
<b>Battery types</b>	Rechargeable Li ION battery Replaceable AA alkaline (ALTAIR 5X only) For battery types see chapters 6.1 and 6.2.
<b>Charging time</b>	≤ 6 hours The maximum safe area charging voltage Um = 6.7 Volts DC
<b>Normal Temperature range</b>	-10 °C to 40 °C (14 °F to 104 °F)
<b>Extended Temperature range</b>	-20 °C to 50 °C (-4 °F to 122 °F) Monochrome display -10 °C to 50 °C (14 °F to 122 °F) color display -20 °C to 40 °C (-4 °F to 104 °F) for devices with ClO <sub>2</sub> sensors
<b>Short Term Operations (15 minutes) temperature range</b>	-40 °C to 50 °C (-40 °F to 122 °F) for devices without PID sensors
<b>Humidity range</b>	15 - 90 % relative humidity, non-condensing, 5 - 95 % RH intermittent
<b>Atmospheric pressure range</b>	80 kPa to 120 kPa (11.6 to 17.4 PSIA)
<b>Ingress protection</b>	IP 65
<b>Measuring methods</b>	Combustible gases - Catalytic or Infrared sensor Oxygen and Toxic gases - Electrochemical or Infrared sensor
<b>Warranty</b>	See chapter

Measuring Range			
<b>ClO<sub>2</sub></b>	0-1.00 ppm	<b>NH<sub>3</sub></b>	0-100 ppm
<b>Cl<sub>2</sub></b>	0-10 ppm	<b>NO</b>	0-200 ppm
<b>CO</b>	0-2000 ppm	<b>NO<sub>2</sub> (S20)</b>	0-20.0 ppm
<b>CO - HC</b>	0-10,000 ppm	<b>NO<sub>2</sub> (XCell)</b>	0-50.0 ppm
<b>Combustible</b>	0-100 % LEL 0-5.00 % CH <sub>4</sub>	<b>O<sub>2</sub></b>	0-30 % Vol.
<b>H<sub>2</sub>S</b>	0-200 ppm	<b>PH<sub>3</sub></b>	0-5.00 ppm
<b>H<sub>2</sub>S - LC</b>	0-100 ppm	<b>PID</b>	0-2000 ppm
<b>HCN</b>	0-30 ppm	<b>SO<sub>2</sub></b>	0-20.0 ppm

US

5.1 Factory-set Alarm Thresholds and Setpoints



Check the monitor or calibration certificate for exact alarm levels as they vary depending on national or corporate regulations.

Sensor	LOW alarm	HIGH alarm	SETPOINT min	SETPOINT max	STEL	TWA
CL <sub>2</sub>	0.5 ppm	1.0 ppm	0.3 ppm	7.5 ppm	1.0 ppm	0.5 ppm
ClO <sub>2</sub>	0.1 ppm	0.3 ppm	0.1 ppm	0.9 ppm	0.3 ppm	0.1 ppm
CO	25 ppm	100 ppm	10 ppm	1700 ppm	100 ppm	25 ppm
CO-HC	25 ppm	100 ppm	10 ppm	8500 ppm	100 ppm	25 ppm
COMB	10 % LEL	20 % LEL	5 % LEL	60 % LEL	-- <sup>1</sup>	-- <sup>1</sup>
H <sub>2</sub> S	10 ppm	15 ppm	5 ppm	175 ppm	15 ppm	10 ppm
H <sub>2</sub> S-LC	5 ppm	10 ppm	1 ppm	70 ppm	10 ppm	1 ppm
HCN	4.5 ppm	10.0 ppm	2.0 ppm	20.0 ppm	10 ppm	4.5 ppm
HCN	4.5 ppm	10.0 ppm	2.0 ppm	20.0 ppm	10.0 ppm	4.5 ppm
NH <sub>3</sub>	25 ppm	50 ppm	10 ppm	75 ppm	35 ppm	25 ppm
NO	25 ppm	75 ppm	15 ppm	100 ppm	25 ppm	25 ppm
NO <sub>2</sub> (S 20)	2.0 ppm	5.0 ppm	1.0 ppm	17.5 ppm	5.0 ppm	2.0 ppm
NO <sub>2</sub> (XCell)	2.5 ppm	5.0 ppm	1.0 ppm	47.5 ppm	5.0 ppm	2.5 ppm
O <sub>2</sub>	19.5 %	23.0 %	5.0 %	24.0 %	-- <sup>1</sup>	-- <sup>1</sup>
PH <sub>3</sub>	0.3 ppm	1.0 ppm	0.3 ppm	3.75 ppm	1.0 ppm	0.3 ppm
SO <sub>2</sub>	2.0 ppm	5.0 ppm	2.0 ppm	17.5 ppm	5.0 ppm	2.0 ppm
IR Butane (25 % Vol)	8 % Vol	15 % Vol	5 % Vol	25 % Vol	-- <sup>1</sup>	-- <sup>1</sup>
IR CO <sub>2</sub> (10 % Vol)	0.5 % Vol	1.5 % Vol	0,2 % Vol	8 % Vol	0.5 % Vol	1.5 % Vol
IR Methane (100 % Vol)	-- <sup>2</sup>	-- <sup>2</sup>	-- <sup>2</sup>	-- <sup>2</sup>	-- <sup>1</sup>	-- <sup>1</sup>
IR Propane (100 % LEL)	15% LEL	29% LEL	9% LEL	100% LEL	-- <sup>1</sup>	-- <sup>1</sup>
IR Propane (100 % Vol)	-- <sup>2</sup>	-- <sup>2</sup>	-- <sup>2</sup>	-- <sup>2</sup>	-- <sup>1</sup>	-- <sup>1</sup>

<sup>1</sup>STEL and TWA not applicable for combustible and oxygen gases.

<sup>2</sup>No alarm thresholds are possible for the 0-100 % Vol Methane and Propane IR sensors. In environments with >100 % LEL combustible gas present, devices with a catalytic combustible LEL sensor will be in a latching over-range alarm, and the 100 % Vol IR sensors will display the % Vol gas reading.



5.2 Performance Specifications

Sensor	Range	Resolution	Reproducibility	Response time
<b>Combustible Gas</b>	0 to 100 % LEL or 0 to 5 % CH <sub>4</sub>	1 % LEL or 0.05 Vol % CH <sub>4</sub>	Normal temp. range: <50 % LEL: 3 % LEL 50-100 % LEL: 5 % LEL <2.5 % CH <sub>4</sub> : 0.15 % CH <sub>4</sub>	t(90)< 15 sec (Pentane) (normal temp.) t(90)< 10 sec (Methane) (normal temp.)
			Extended temp. range: <50 % LEL: 5 % LEL 50-100% LEL: 8% LEL <2.5 % CH <sub>4</sub> : 0.25 % CH <sub>4</sub> 2.5-5.00 % CH <sub>4</sub> : 0.40 % CH <sub>4</sub>	
<b>Oxygen</b>	0 – 30% O <sub>2</sub> *	0.1% O <sub>2</sub>	0.7 % O <sub>2</sub> for 0 – 30 % O <sub>2</sub>	t(90)< 10 sec (normal temp.)
<b>Carbon Monoxide</b>	0-2000 ppm CO	1 ppm CO	normal temperature range: ±5 ppm CO or 10 % of reading, whichever is greater	t(90)< 15 sec (normal temp.)
			extended temperature range: ±10 ppm CO or 20 % of reading, whichever is greater	
<b>Hydrogen Sulfide</b>	0-200 ppm H <sub>2</sub> S	1 ppm H <sub>2</sub> S, for 3 to 200 ppm H <sub>2</sub> S	normal temperature range: ±2 ppm H <sub>2</sub> S or 10 % of reading, whichever is greater	t(90)< 15 sec (normal temp.)
			extended temperature range: ±20 ppm H <sub>2</sub> S or 20 % of reading, whichever is greater	

IR Sensors

Sensor	Range	Resolution	Response time at 20 °C	Reproducibility of the zero point	Reproducibility of the measured value <sup>1)</sup>
t <sub>90</sub>					
Carbon Dioxide	0-10 % Vol	0.01 % Vol	≤ 35 s	≤ ± 0.01 % Vol	≤ ±4 %
Methane	0-100 % Vol	1 % Vol	≤ 34 s	≤ ± 5 % Vol	≤ ±10 %
Propane	0-100 % Vol	1 % Vol	≤ 36 s	≤ ± 3 % Vol	≤ ±8 %
Propane	0-100%LEL	1% LEL	≤ 32 s	≤ ± 3% LEL	≤ ±8%
Butane	0-25 % Vol	0.1 % Vol	≤ 35 s	≤ ± 0.5 % Vol	≤ ±4 %



**Additional Toxic Sensors**

Sensor	Range (ppm)	Resolu- tion (ppm)	Reproducibility		Nominal response*
			Normal temperature range:	Extended temp. range:	
<b>Cl<sub>2</sub> Chlorine</b>	0 - 10	0.05	±0.2 ppm or 10 % of reading, whichever is greater	±0.5 ppm or 20 % of reading, whichever is greater	t(90)< 30 s
<b>ClO<sub>2</sub> Chlorine dioxide</b>	0 - 1	0.01	±0.1 ppm or 10 % of reading, whichever is greater	±0.2 ppm or 20 % of reading, whichever is greater	t(90)< 2 min
<b>CO-HC Carbon Monoxide</b>	0 - 10000	5	±5 ppm or 10 % of reading, whichever is greater	±10 ppm or 20 % of reading, whichever is greater	t(90)< 15 s
<b>H<sub>2</sub>S-LC Hydrogen Sulfide</b>	0 - 100	0.1	±0.2 ppm or 10 % of reading, whichever is greater	±0.5 ppm or 20 % of reading, whichever is greater	t(90)< 15 s
<b>HCN Hydrogen cyanide</b>	0 - 30	0.5	±1 ppm or 10 % of reading, whichever is greater	±2 ppm or 20 % of reading, whichever is greater	t(90)< 30 s
<b>NH<sub>3</sub> Ammonia</b>	0 - 100	1	±2 ppm or 10 % of reading, whichever is greater	±5 ppm or 20 % of reading, whichever is greater	t(90)< 40 s
<b>NO<sub>2</sub> Nitrogen dioxide (S 20)</b>	0 - 20	0.1	±2 ppm or 10 % of reading, whichever is greater	±3 ppm or 20 % of reading, whichever is greater	t(90)< 40 s
<b>NO<sub>2</sub> Nitrogen dioxide (XCell)</b>	0 - 50	0.1	±1 ppm or 10 % of reading, whichever is greater	±2 ppm or 20 % of reading, whichever is greater	t(90)< 15 s
<b>NO Nitric oxide</b>	0 - 200	1	±5 ppm or 10 % of reading, whichever is greater	±10 ppm or 20 % of reading, whichever is greater	t(90)< 40 s
<b>PH<sub>3</sub> Phosphine</b>	0 - 5	0.05	±0.2 ppm or 10 % of reading, whichever is greater	±0.25 ppm or 20 % of reading, whichever is greater	t(90)< 30 s
<b>SO<sub>2</sub> Sulfur dioxide</b>	0 - 20	0.1	±2 ppm or 10 % of reading, whichever is greater	±3 ppm or 20 % of reading, whichever is greater	t(90)< 20 s

\* Response time is for normal temperature range with sensor in position #3



5.3 Calibration Specifications

Sensor	Zero Gas	Zero Cal Value**	Span Cal Gas	Span Cal	
				Value	Time (min)
COMB Pentane	Fresh Air	0	1.45 % Vol Methane	58 % LEL	1
COMB Methane (0 - 5 % Vol)	Fresh Air	0	2.5 % Vol Methane	2,5 %	1
COMB Methane (4.4 % Vol)	Fresh Air	0	1.45 % Vol Methane	33 % LEL	1
COMB Propane (2.1 % Vol)	Fresh Air	0	1.45 % Vol Methane	46 % LEL	1
COMB Propane (1.7 % Vol)	Fresh Air	0	1.45 % Vol Methane	37 % LEL	1
COMB Butane (1.4 % Vol)	Fresh Air	0	1.45 % Vol Methane	46 % LEL	1
COMB Methane (5 % Vol)	Fresh Air	0	1.45 % Vol Methane	29 % LEL	1
COMB Hydrogen (4,0 % Vol)	Fresh Air	0	1.45 % Vol Methane	33 % LEL	1
O <sub>2</sub>	Fresh Air	20.8 %	15 % O <sub>2</sub>	15 %	1
CO	Fresh Air	0	60 ppm CO	60 ppm	1
H <sub>2</sub> S	Fresh Air	0	20 ppm H <sub>2</sub> S	20 ppm	1
SO <sub>2</sub>	Fresh Air	0	10 ppm SO <sub>2</sub>	10 ppm	1
Cl <sub>2</sub>	Fresh Air	0	10 ppm Cl <sub>2</sub>	10 ppm	2
NO	Fresh Air	0	50 ppm NO	50 ppm	4
NO <sub>2</sub>	Fresh Air	0	10 ppm NO <sub>2</sub>	10 ppm	2
NH <sub>3</sub>	Fresh Air	0	25 ppm NH <sub>3</sub>	25 ppm	2
PH <sub>3</sub>	Fresh Air	0	0.5 ppm PH <sub>3</sub>	0.5 ppm	1
HCN	Fresh Air	0	10 ppm HCN	10 ppm	4
*ClO <sub>2</sub>	Fresh Air	0	2 ppm Cl <sub>2</sub>	0.8 ppm	6
IR CO <sub>2</sub> (10 % Vol)	Fresh Air	0.03 %	2.5 % CO <sub>2</sub>	2.5 %	2
IR Butane (25 % Vol)	Fresh Air	0	8 % Vol	8 % Vol	2
IR Propane (100 % Vol)	Fresh Air	0	50 % Vol Propane	50 % Vol	2
IR Propane (100 % LEL)	Fresh Air	0	0.6 % Vol Propane	29% LEL	2
IR Methane (100 % Vol)	Fresh Air	0	50 % Vol Methane	50 % Vol	2

Span values can be changed if using different gas cylinders than those listed. Changes can be made using MSA Link software and through calibration cylinder setup.

\*For most accurate results, calibration with ClO<sub>2</sub> is recommended.

\*\*Zero cal time is one minute if a catalytic combustible sensor is installed - 30 seconds if not.



LEL values, if not listed here, are according to EN 60079-20-1. Local regulations may differ.

5.4 Combustible Gas Cross Reference Factors for General-Purpose Calibration Using Calibration Cylinder (Part no. 10053022)

See the applicable addendum on the Product CD.



## 6 Certification

See device label for the certification that applies to your specific device.

### USA and Canada

USA	
<b>USA / NRTL (Intrinsic Safety, Non-Mining)</b>	UL913 for Class I, Div. 1, Groups A, B, C and D, Class II, Div. 1, -40 °C to +50 °C, T4
Canada	
<b>Canada / CSA (Intrinsic Safety, Combustible Performance, Non- Mining)</b>	CSA C22.2 No. 157 for Class I, Div. 1, Groups A, B, C and D CSA C22.2 No. 152 M1984 Combustible Performance Tamb = -40 °C to +50 °C, T4 for Intrinsic Safety Tamb = -20 °C to +50 °C, T4 for Combustible Performance
<b>Australia (Intrinsic Safety, Industrial and Mining - TestSafe)</b>	ALTAIR5X / ALTAIR5XiR Ex ia s Zone 0 I IP65 Ex ia s Zone 0 IIC T4 IP65, Tamb = -40 °C to +50 °C IEC60079-0, IEC60079-1, IEC60079-11, AS-1826

### 6.1 Marking, Certificates and Approvals According to the Directive 94/9/EC (ATEX)

#### ALTAIR 5X

Manufacturer:	Mine Safety Appliances Company, LLC 1000 Cranberry Woods Drive Cranberry Township, PA 16066 USA
Product:	<b>ALTAIR 5X</b>
EC-Type Examination Certificate:	FTZU 08 ATEX 0340 X
Type of protection:	EN 60079-0:2012, EN 60079-1:2014, EN 60079-11:2007
Performance	EN 60079-18:2009, EN 60079-26:2007, EN 50303:2000 EN 60079-29-1:2007, EN 50104:2010, EN 50271:2010
Gas	measuring range 0-100 % LEL: Methane, Hydrogen, Propane, Butane, Pentane, Oxygen: measuring range 0-25 Vol %, indication 0-30 Vol %
Marking:	 <p>I M1 Ex ia I Ma II 1G Ex ia IIC T4 Ga when combustible XCell sensor is not installed II 2G Ex db ia mb IIC T4 Gb Ta = -40 °C to +50 °C</p>
Alkaline	T4: Duracell LR6,MN 1500
Li-Ion	Um 6,7 V  IP 65

**Special Conditions:**

The model ALTAIR 5X shall be charged by Manufacturer's chargers only (0 - 45 °C) and opened in a non-hazardous area.

When using the ALTAIR 5X or ALTAIR 5X IR in a hazardous area, the device should be worn or carried on the body. Do not store the device in a hazardous location. This prevents the possibility of the device building up an electrostatic charge.

The antenna used for activation of the internal RFID tag with the RF radiation power shall not exceed 6 W for Group I and 2 W for Group IIC.

In the event of a combustible sensor overrange, the device should be exposed to fresh air for a minimum of 20 minutes. Following this, a Zero Calibration procedure should be performed.

The warm-up time for oxygen is up to 180 sec.

The alarm set points are not applied for measuring oxygen inertisation and it shall be taken into account.

Capacitance:

5X Alkaline Battery Pack Screws:	6 pF
5X Rechargeable Battery Pack D-Ring:	26 pF
5X Charge contact pins:	16 pF
5XiR Rechargeable Battery Pack D-Ring:	33 pF
5XiR Charge contact pins:	24 pF

Quality Assurance Notification:	0080
Year of Manufacture:	see Label
Serial Nr.:	see Label

National Certification:	FTZU 09 E 0026
Performance:	EN 45544-1:1999, EN 45544-2:1999 EN 50104 : 2010 CO : 0-2000 ppm

Gas:	H <sub>2</sub> S : 0-200 ppm Oxygen: measuring range 0-25 Vol %, indication range 0-30 Vol %
------	---

Capacitance:

5X Alkaline Battery Pack Screws:	6 pF
5X Rechargeable Battery Pack D-Ring:	26 pF
5X Charge contact pins:	16 pF
5XiR Rechargeable Battery Pack D-Ring:	33 pF
5XiR Charge contact pins:	24 pF

Quality Assurance Notification:	0080
Year of Manufacture:	see Label
Serial Nr.:	see Label

National Certification:	FTZU 09 E 0026
Performance:	EN 45544-1:1999, EN 45544-2:1999 EN 50104 : 2010 CO : 0-2000 ppm

Gas:	H <sub>2</sub> S : 0-200 ppm Oxygen: measuring range 0-25 Vol %, indication range 0-30 Vol %
------	---



**ALTAIR 5X IR**

Manufacturer:	Mine Safety Appliances Company, LLC 1000 Cranberry Woods Drive Cranberry Township, PA 16066 USA
Product:	<b>ALTAIR 5X IR</b>
EC-Type Examination Certificate:	FTZU 09 ATEX 0006 X
Type of protection:	EN 60079-0:2012, EN 60079-1:2014, EN 60079-7:2007 EN 60079-11:2007, EN 50303:2000, EN 60079-18:2009
Performance	EN 60079-29-1:2007, EN 50 104:2010, EN 50271:2010
Gas	measuring range 0-100 % LEL: Methane, Hydrogen, Propane, Butane, Pentane Oxygen: measuring range 0-25 Vol %, indication range 0 - 30 Vol %
Marking:	 I M1 Ex ia I Ma II 2G Ex db e ia mb IIC T4 Gb Ta = -40 °C to +50 °C
Li-Ion	Um 6,7 V IP 65

**Special Conditions:**

The model ALTAIR 5X IR shall be charged by Manufacturer's chargers only (0 - 45 °C) and opened in a non-hazardous area.

When using the ALTAIR 5X or ALTAIR 5X IR in a hazardous area, the device should be worn or carried on the body. Do not store the device in a hazardous location. This prevents the possibility of the device building up an electrostatic charge.

The antenna used for activation of the internal RFID tag with the RF radiation power shall not exceed 6 W for Group I and 2 W for Group IIC.

In the event of a combustible sensor overrange, the device should be exposed to fresh air for a minimum of 20 minutes. Following this, a Zero Calibration procedure should be performed.

The pressure range is 90 kPa to 120 kPa for gas CH<sub>4</sub> in range 0-100 % (v/v) for IR sensor.

The warm-up time for oxygen is up to 180 sec.

The alarm set points are not applied for measuring oxygen inertisation and it shall be taken into account.

Quality Assurance Notification:	0080
Year of Manufacture:	see Label
Serial No.:	see Label
National Certification:	FTZU 09 E 0027 EN 45544-1: 1999 EN 45544-2: 1999
Performance:	EN 45544-3: 1999 EN 50104 : 2010 CO: 0-2000 ppm CO <sub>2</sub> : 0-10 % v/v
Gas:	H <sub>2</sub> S: 0-200 ppm Oxygen: measuring range 0-25 Vol %, indication range 0-30 Vol %
Capacitance:	

US

5X Alkaline Battery Pack Screws:	6 pF
5X Rechargeable Battery Pack D-Ring:	26 pF
5X Charge contact pins:	16 pF
5XiR Rechargeable Battery Pack D-Ring:	33 pF
5XiR Charge contact pins:	24 pF
Quality Assurance Notification:	0080
Year of Manufacture:	see Label
Serial Nr.:	see Label
National Certification:	FTZU 09 E 0026
Performance:	EN 45544-1:1999, EN 45544-2:1999 EN 50104 : 2010 CO : 0-2000 ppm
Gas:	H <sub>2</sub> S : 0-200 ppm Oxygen: measuring range 0-25 Vol %, indication range 0-30 Vol %

**6.2 Marking, Certificates and Approvals According to IECEx  
ALTAIR 5X**

Manufacturer:	Mine Safety Appliances Company, LLC 1000 Cranberry Woods Drive Cranberry Township, PA 16066 USA
Product:	<b>ALTAIR 5X</b>
IECEX-Type Examination Certificate:	IECEX TSA 09.0013X
Type of protection:	IEC 60079-0:2004, IEC 60079-1:2003 IEC 60079-11:2006
Performance	none
Marking:	Ex ia I Ma Ex ia IIC T4 Ga Ex d ia IIC T4 Gb when combustible XCell sensor is installed Ta = -40 °C to +50 °C
Alkaline	T4: Energizer E91, LR6, MN1500 Duracell LR6, MN 1500
Li-Ion	Um ≤ 6,7 V DC IP 65

**Special Conditions:**

The model ALTAIR 5X shall be charged by Manufacturer's chargers only (0 - 45 °C) and opened in a non-hazardous area.

When using the ALTAIR 5X or ALTAIR 5X IR in a hazardous area, the device should be worn or carried on the body. Do not store the device in a hazardous location. This prevents the possibility of the device building up an electrostatic charge.

The antenna used for activation of the internal RFID tag with the RF radiation power shall not exceed 6 W for Group I and 2 W for Group IIC.

In the event of a combustible sensor overrange, the device should be exposed to fresh air for a minimum of 20 minutes. Following this, a Zero Calibration procedure should be performed.

The warm-up time for oxygen is up to 180 sec.

The alarm set points are not applied for measuring oxygen inertisation and it shall be taken into account.

Capacitance:

5X Alkaline Battery Pack Screws:	6 pF
5X Rechargeable Battery Pack D-Ring:	26 pF
5X Charge contact pins:	16 pF
5XiR Rechargeable Battery Pack D-Ring:	33 pF
5XiR Charge contact pins:	24 pF

US

**ALTAIR 5X IR**

Manufacturer: Mine Safety Appliances Company, LLC  
 1000 Cranberry Woods Drive  
 Cranberry Township, PA 16066 USA

Product: **ALTAIR 5X IR**

IECEX-Type Examination Certificate: IECEx TSA 09.0014X  
 IEC 60079-0:2004, IEC 60079-1:2003  
 Type of protection: IEC 60079-11:2006

Performance none

Marking: Ex d e ia I Ma  
 EX d e ia IIC T4 Gb  
 Ta = -40 °C to +50 °C

Li-Ion Um ≤ 6,7 V DC  
 IP 65

**Special Conditions:**

The model ALTAIR 5X shall be charged by Manufacturer's chargers only (0 - 45 °C) and opened in a non-hazardous area.

When using the ALTAIR 5X or ALTAIR 5X IR in a hazardous area, the device should be worn or carried on the body. Do not store the device in a hazardous location. This prevents the possibility of the device building up an electrostatic charge.

The antenna used for activation of the internal RFID tag with the RF radiation power shall not exceed 6 W for Group I and 2 W for Group IIC.

In the event of a combustible sensor overrange, the device should be exposed to fresh air for a minimum of 20 minutes. Following this, a Zero Calibration procedure should be performed.

The warm-up time for oxygen is up to 180 sec.

The alarm set points are not applied for measuring oxygen inertisation and it shall be taken into account.

Capacitance:

5X Alkaline Battery Pack Screws:	6 pF
5X Rechargeable Battery Pack D-Ring:	26 pF
5X Charge contact pins:	16 pF
5XiR Rechargeable Battery Pack D-Ring:	33 pF
5XiR Charge contact pins:	24 pF

US

## 7 XCell Sensor Patents

SENSOR	PART NO.	PATENT STATUS
Combustible	10106722	US8826721
Oxygen	10106729	US8790501
Carbon Monoxide / Hydrogen Sulfide	10106725	US8790501, US8702935
Ammonia	10106726	US8790501, US8623189
Chlorine	10106728	US8790501, US8623189
Sulphur Dioxide	10106727	US8790501, US8623189

## 8 Ordering Information

### 8.1 US

#### Gas Cylinder Parts List

Gases	Gases Mix	MSA P/N		
		ECONO-CAL (34 L)	RP (58 L)	Recommended CAL Gas for:
1	10 % CO <sub>2</sub> in N <sub>2</sub>		10081603	
1	8 % Butane in N <sub>2</sub> (6L)	10075802		25 % Vol Butane IR
1	50 % Vol Methane in N <sub>2</sub> (103L)		10075804	100 % Vol Methane IR
1	100 % Vol Methane		711014	
1	10 ppm NO <sub>2</sub> in Air	711068	808977	NO <sub>2</sub> sensor
1	10 ppm SO <sub>2</sub> in Air	711070	808978	SO <sub>2</sub> sensor
1	25 ppm NH <sub>3</sub> in N <sub>2</sub>	711078	814866	NH <sub>3</sub> sensor
1	10 ppm Cl <sub>2</sub> in N <sub>2</sub>	711066	806740	Cl <sub>2</sub> sensor
1	2 ppm Cl <sub>2</sub> in N <sub>2</sub>	711082	10028080	ClO <sub>2</sub> sensor
1	10 ppm HCN in N <sub>2</sub>	711072	809351	HCN sensor
1	0.5 ppm PH <sub>3</sub> in N <sub>2</sub>	711088	710533	PH <sub>3</sub> sensor
3	1.45 % CH <sub>4</sub> , 15.0 % O <sub>2</sub> , 20 ppm H <sub>2</sub> S	10048790	10048788	
3	2.50 % CH <sub>4</sub> , 15.0 % O <sub>2</sub> , 20 ppm H <sub>2</sub> S	10048888	10048889	
3	1.45 % CH <sub>4</sub> , 15.0 % O <sub>2</sub> , 60 ppm CO	10048789	478191 (100L)	
3	2.50 % CH <sub>4</sub> , 15.0 % O <sub>2</sub> , 60 ppm CO	10049056	813718 (100L)	
4	1.45 % CH <sub>4</sub> , 15.0 % O <sub>2</sub> , 60 ppm CO, 10 ppm NO <sub>2</sub>	10058036	10058034	
4	1.45 % CH <sub>4</sub> , 15.0 % O <sub>2</sub> , 60 ppm CO, 20 ppm H <sub>2</sub> S	10048280	10045035	
4	2.50 % CH <sub>4</sub> , 15.0 % O <sub>2</sub> , 60 ppm CO, 20 ppm H <sub>2</sub> S	10048981	10048890	
4	2.50 % CH <sub>4</sub> , 15.0 % O <sub>2</sub> , 60 ppm CO, 10 ppm NO <sub>2</sub>	10058172	10058172	
5	1.45 % CH <sub>4</sub> , 15.0 % O <sub>2</sub> , 60 ppm CO, 20 ppm H <sub>2</sub> S, 2.5% CO <sub>2</sub>		10103262	10 % CO <sub>2</sub> IR
5	1.45 % CH <sub>4</sub> , 15.0 % O <sub>2</sub> , 60 ppm CO, 20 ppm H <sub>2</sub> S, 10 ppm SO <sub>2</sub>	10098855	10117738	SO <sub>2</sub> sensor

US



## 8.2 Outside US

Description	Part No.
<b>Gas</b>	
Cylinder 34L, 60 ppm CO	10073231
Cylinder 34L, 40 ppm H <sub>2</sub> S	10011727
Cylinder 34L, 25 ppm NH <sub>3</sub>	10079807
Cylinder 34L, 10 ppm Cl <sub>2</sub>	10011939
Cylinder 34L, 10 ppm SO <sub>2</sub>	10079806
Cylinder 34L, 10 ppm NO <sub>2</sub>	10029521
Cylinder 34L, 0.5 ppm PH <sub>3</sub>	10029522
Cylinder 34L, 2 ppm Cl <sub>2</sub> (To calibrate ClO <sub>2</sub> sensor)	711082
Cylinder 34L, 10 ppm HCN	711072
Calibration Cylinder 58L (1.45 % CH <sub>4</sub> , 15.0 % O <sub>2</sub> , 60 ppm CO, 20 ppm H <sub>2</sub> S)	10053022
Calibration Cylinder 58L (1.45 % CH <sub>4</sub> , 15.0 % O <sub>2</sub> , 60 ppm CO, 20 ppm H <sub>2</sub> S) (US)	10045035
Cylinder 34L, 50 ppm NO	10126429
Cylinder 58L (0,4 % Propane, 15 % O <sub>2</sub> , 60 ppm CO, 20 ppm H <sub>2</sub> S)	10086549
Cylinder 58L (1.45 % CH <sub>4</sub> , 2.5 % CO <sub>2</sub> , 60 ppm CO, 20 ppm H <sub>2</sub> S, 15 % O <sub>2</sub> )	10102853
Cylinder 34L (1.45 % CH <sub>4</sub> , 15 % O <sub>2</sub> , 60 ppm CO, 20 ppm H <sub>2</sub> S, 10 ppm SO <sub>2</sub> ,)	10122425
Cylinder 58L (1.45 % CH <sub>4</sub> , 15 % O <sub>2</sub> , 60 ppm CO, 20 ppm H <sub>2</sub> S, 10 ppm SO <sub>2</sub> ,)	10122426
<b>For IR Sensors</b>	
Cylinder 34L, 2.5 % Vol CO <sub>2</sub>	10069618
Cylinder 34L, 8 % Vol Butane	10078012
Cylinder 34L, 20 % Vol Methane	10022595
Cylinder 34L, 50 % Vol Methane	10029500

## 8.3 Accessories

Description	Part No.
Universal Demand Regulator kit	10034391
MSA Link USB dongle	10082834
MSA Link Datalogging Software	10088099
Shoulder Strap	474555
Retractable Line with Belt Clip	10050976
Holster, leather	10099648
Sampling Probe, flexible 30 cm, conductive	10103191
Sampling Line, 1,5 m, conductive	10103188
Sampling Line, 3 m, conductive	10103189
Sampling Line, 5 m, conductive	10103190
Sampling System w/floating probe, 5 m, PU conductive	10082307

US

Description	Part No.
Sampling Line, 20 m, conductive	10159430
Sampling Line, 30 m, conductive	10159431
Probe, 1 ft. straight PEEK	10042621
Probe, 3 ft. straight PEEK	10042622
Polyurethane Sample Line, 10 ft.	10040665
Polyurethane Sample Line, 25 ft.	10040664
Polyurethane Sample Line, 3 ft. Coiled	10040667
(Cl2, ClO2, NH3) 5 ft. PU Coiled Sample line & probe, kit	10105210
(Cl2, ClO2, NH3) 5 ft. PU Sample line & probe, kit	10105251
(Cl2, ClO2, NH3) 10 ft. Teflon Sample line & probe, kit	10105839
Replacement Filters for probe, 10 pack	801582
Charger only (North America)	10087913
Charger only (Global version)	10092936
Charging Cradle with Barrier- (North America)	10093055
Charging Cradle - (North America)	10093054
Charging Cradle (Europe)	10093057
Charging Cradle (Australia)	10093056
Vehicle Charger Cradle	10099397
Cradle Only - (no charger)	10093053
ALTAIR 5/5X Multi-Unit Charger, 4 Unit (North American)	10127427
ALTAIR 5/5X Multi-Unit Charger, 4 Unit (Europe)	10127428
ALTAIR 5/5X Multi-Unit Charger, 4 Unit (UK)	10127429
ALTAIR 5/5X Multi-Unit Charger, 4 Unit (Australia)	10127430
ALTAIR 5/5X Multi-Unit Charger, 4 Unit No Power Cord	10128704
Carrying Case	10152079



Please note that not all accessories are available in every local market. Check availability with the local MSA representative .

Replacement Parts

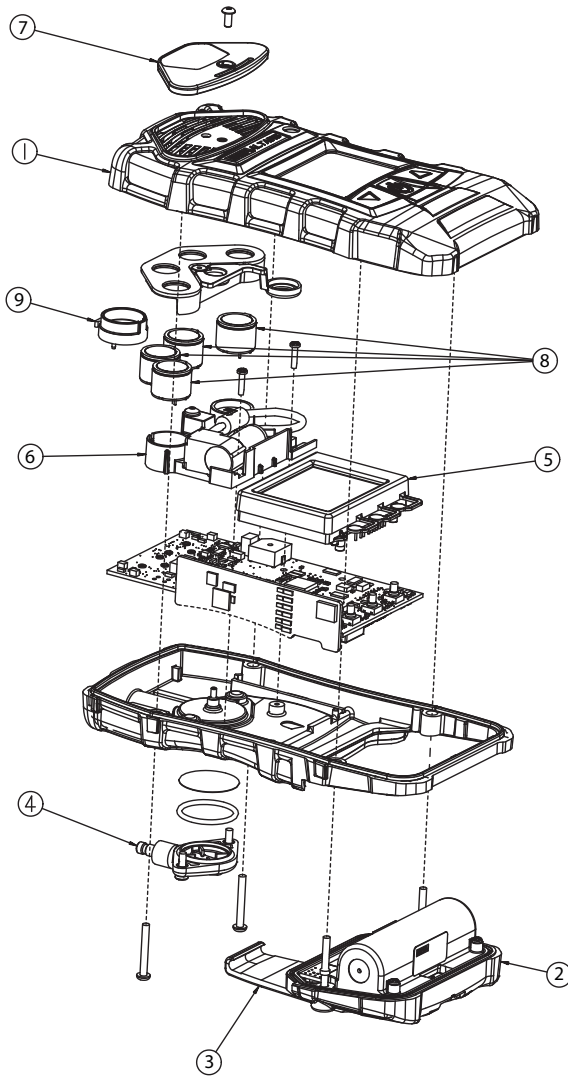

US

No.	Description	Part No.
1	Case assembly, upper, with label	10114853
	Case assembly, upper, (phosphorescent), with label	10114854
2	Battery pack, rechargeable, North America, ALTAIR 5X	10114835
	Battery pack, rechargeable, EU/Aus, ALTAIR 5X	10114836
	Battery pack, rechargeable, North America, ALTAIR 5X IR	10114839
	Battery pack, rechargeable, EU/Aus, ALTAIR 5X IR	10114851
	Battery Pack, rechargeable, North America ALTAIR 5X IR (phosphorescent)	10114840
3	Battery Pack, rechargeable, European/Australian ALTAIR 5X IR (phosphorescent)	10114852
	Kit, belt clip replacement, (ALTAIR 5X rechargeable)	10094830
	Kit, maintenance (includes filters, o-ring, screws)	10114949
4	Kit, maintenance, reactive gas (Cl2, ClO2, NH3) (includes filters, o-ring, screws)	10114950
	Filter cover assembly	10083591
5	Display assembly, monochrome	10111389
	Display assembly, color	10148366
6	Sensor bracket assembly with pump, ALTAIR 5X (includes vibrator motor)	10114804
	Sensor bracket assembly with pump, ALTAIR 5X IR (includes vibrator motor)	10114805
7	Kit, pump cap replacement	10114855

No.	Description	Part No.
	Sensor, HCN (Series 20)	10106375
	XCell Sensor, Cl <sub>2</sub>	10106728
	Sensor, ClO <sub>2</sub> (Series 20)	10080222
	XCell Sensor, SO <sub>2</sub>	10106727
	Sensor, NO <sub>2</sub> (Series 20)	10080224
	XCell Sensor, NH <sub>3</sub>	10106726
	Sensor, PH <sub>3</sub> (Series 20)	10116638
	XCell Sensor, COMB	10106722
	XCell Sensor, O <sub>2</sub>	10106729
8	XCell Sensor, CO	10106724
	XCell Sensor, H <sub>2</sub> S	10106723
	XCell Sensor, CO-H <sub>2</sub> S, Two-Tox	10106725
	XCell Sensor, CO/ NO <sub>2</sub>	10121217
	XCell Sensor, CO-HC	10121216
	XCell Sensor, H <sub>2</sub> S-LC/CO	10121213
	XCell Sensor, CO-H <sub>2</sub> Res/H <sub>2</sub> S	10121214
	Sensor, NO (Series 20)	10114750
	XCell Sensor plug	10105650
	20 mm sensor plug	10088192
9	XCell adapter socket	10110183

Description	Part No.
<b>IR sensors - Must be repaired or replaced at a Certified Repair Center</b>	
IR sensor HC 0-25 % Vol Butane	10145739-SP
IR sensor HC 0-100 % Vol Methane	10145752-SP
IR sensor HC 0-100 % Vol Propane	10145740-SP
IR sensor 0-10 % Vol CO <sub>2</sub>	10145738-SP
IR sensor 0-100% LEL Propane	10145751-SP

US

9 Appendix – Flow Charts

9.1 Basic Operation

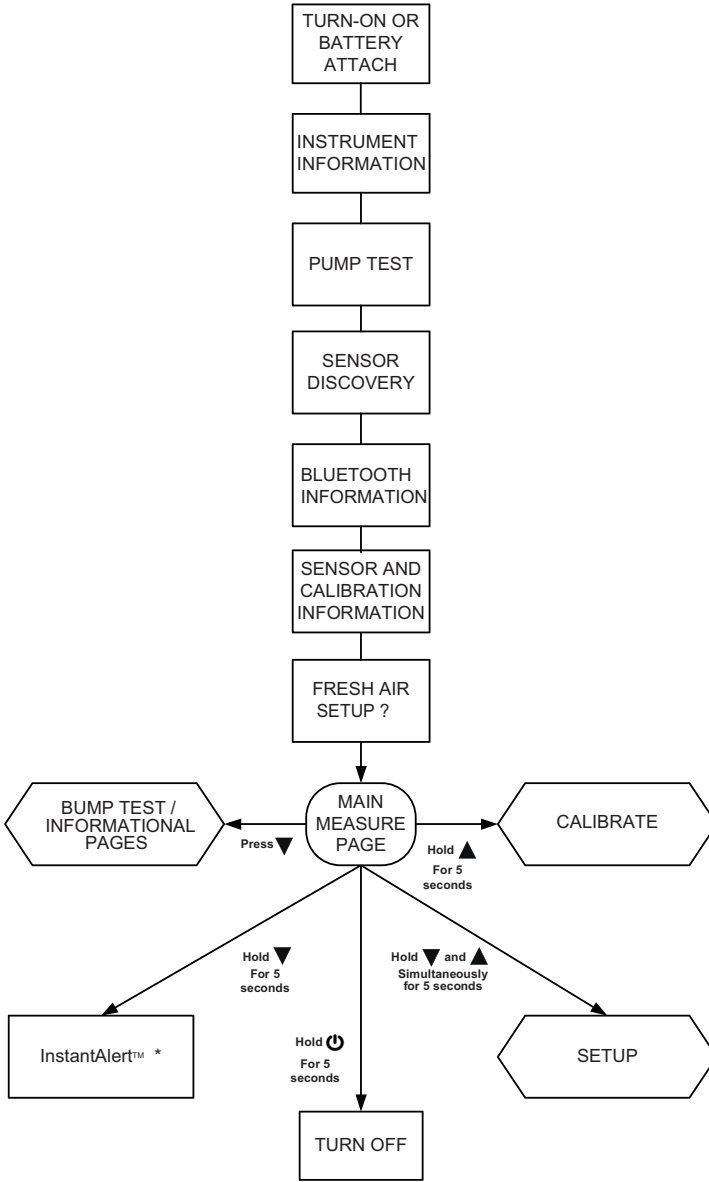

\* IF ENABLED

US

9.2 Bump Test/ Informational Pages

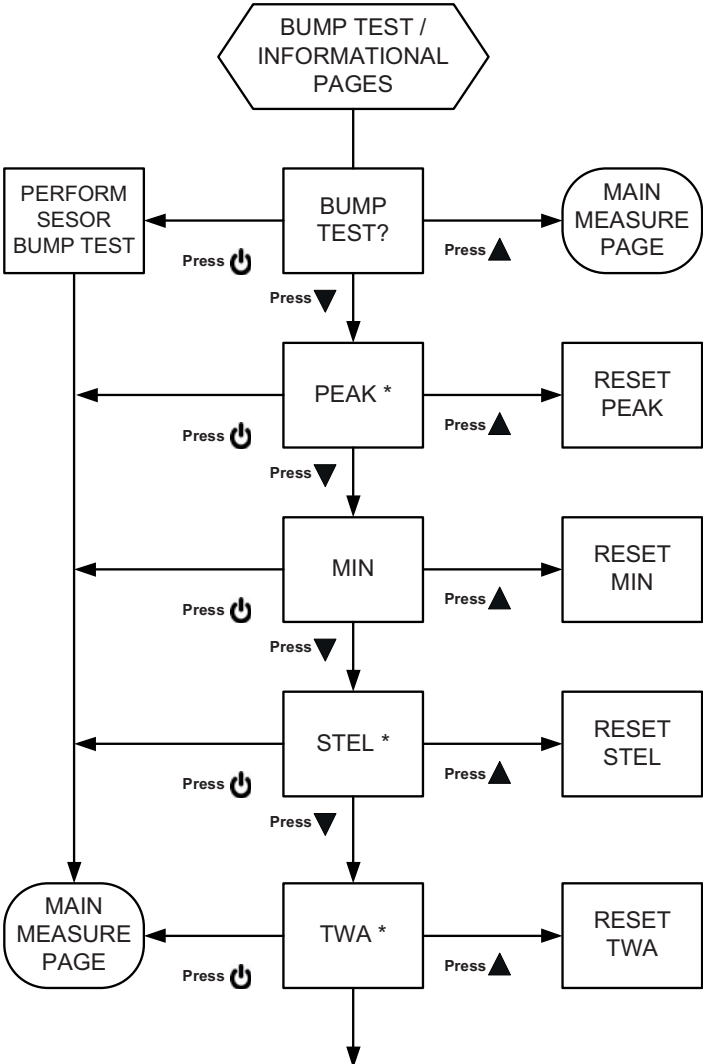

\* IF ENABLED (NOT VALID FOR ALL SENSORS)



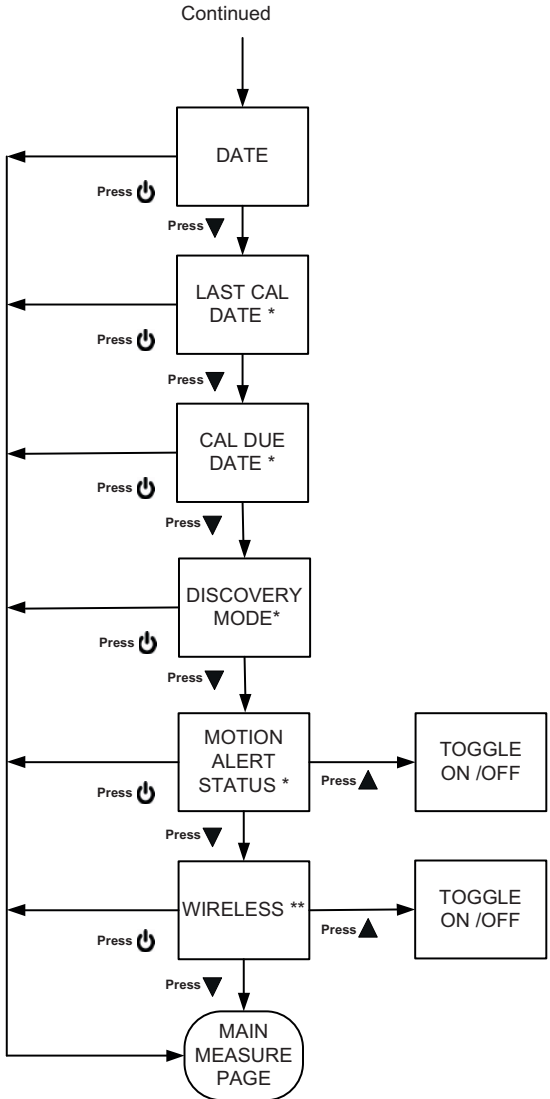

\* IF ENABLED

\*\* IF WIRELESS IS INSTALLED





9.3 Calibrations

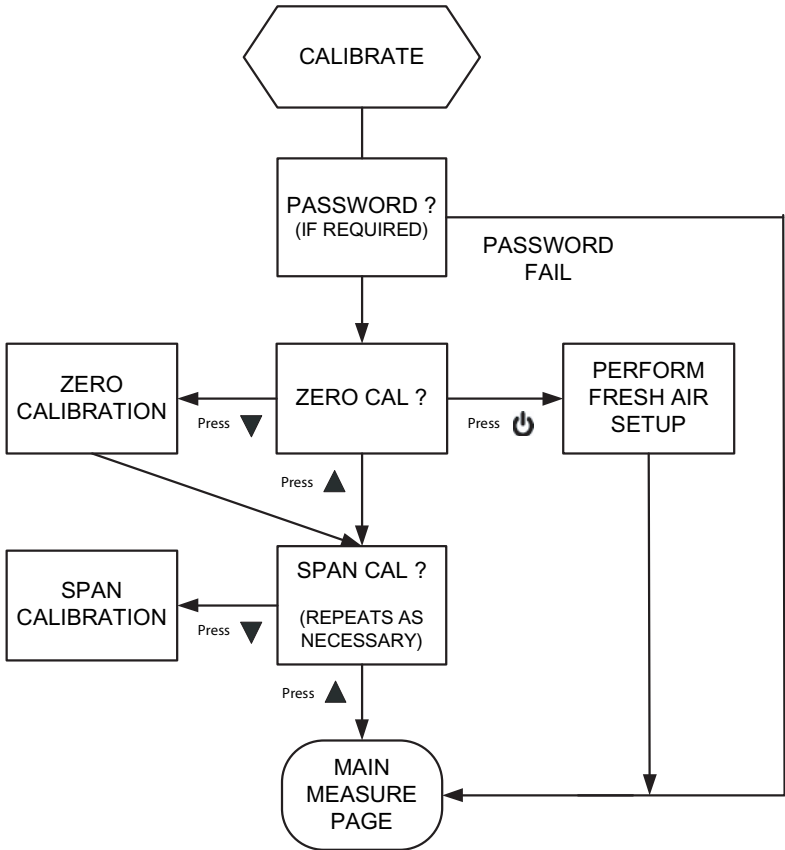

9.4 Setup

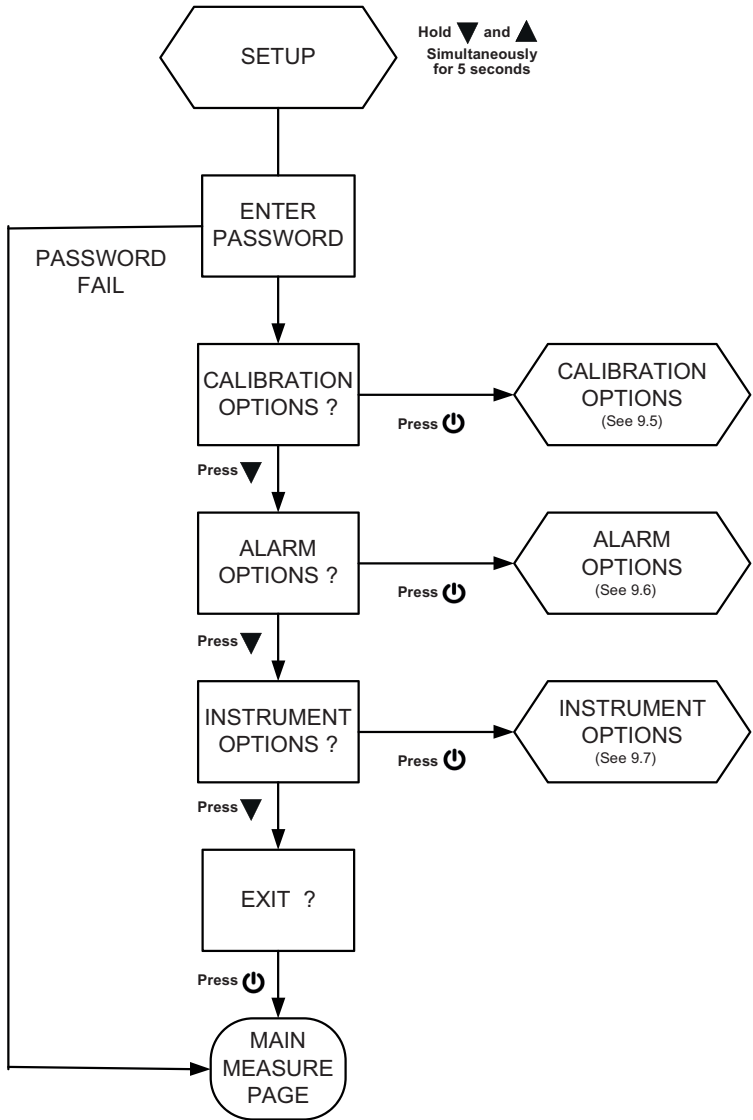

9.5 Calibration Options

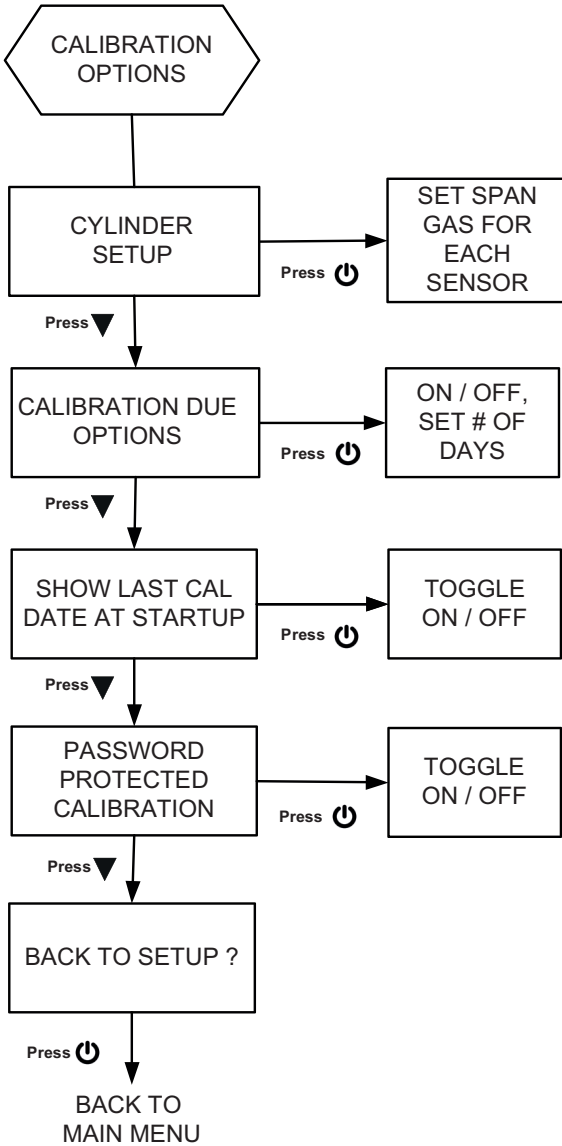

US

9.6 Alarm Options

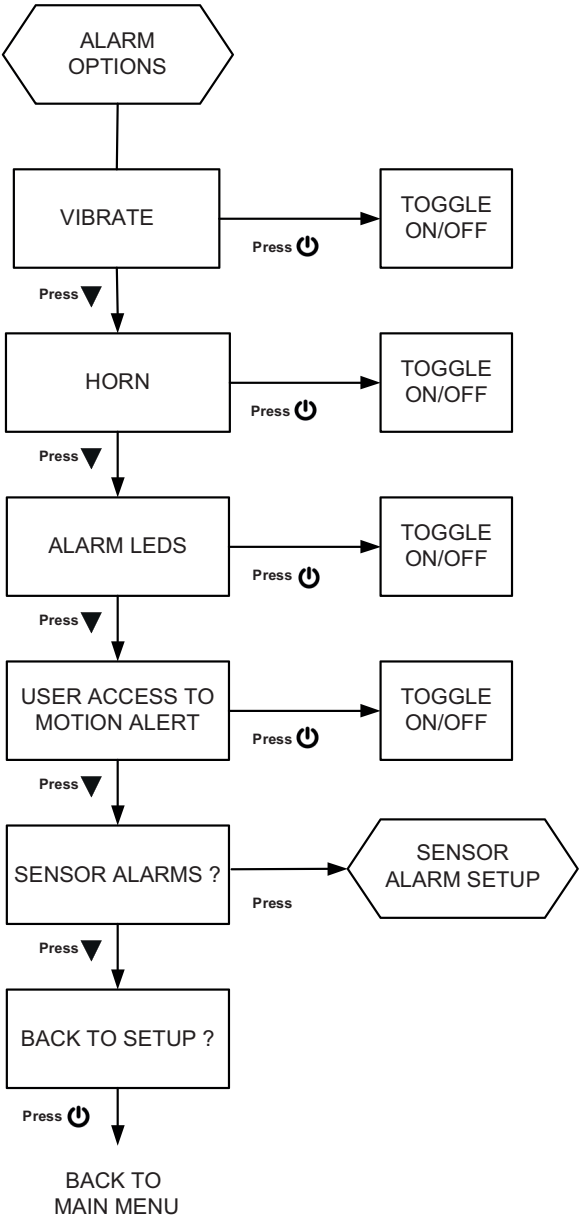

9.7 Sensor Alarm Setup

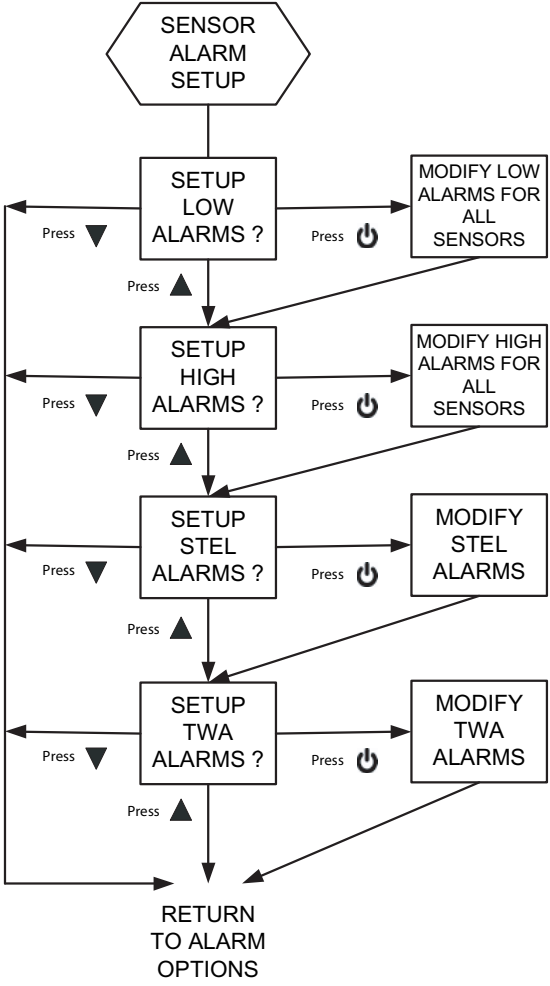

NOTE: STEL AND TWA ARE NOT VALID FOR ALL SENSORS



9.8 Instrument Options

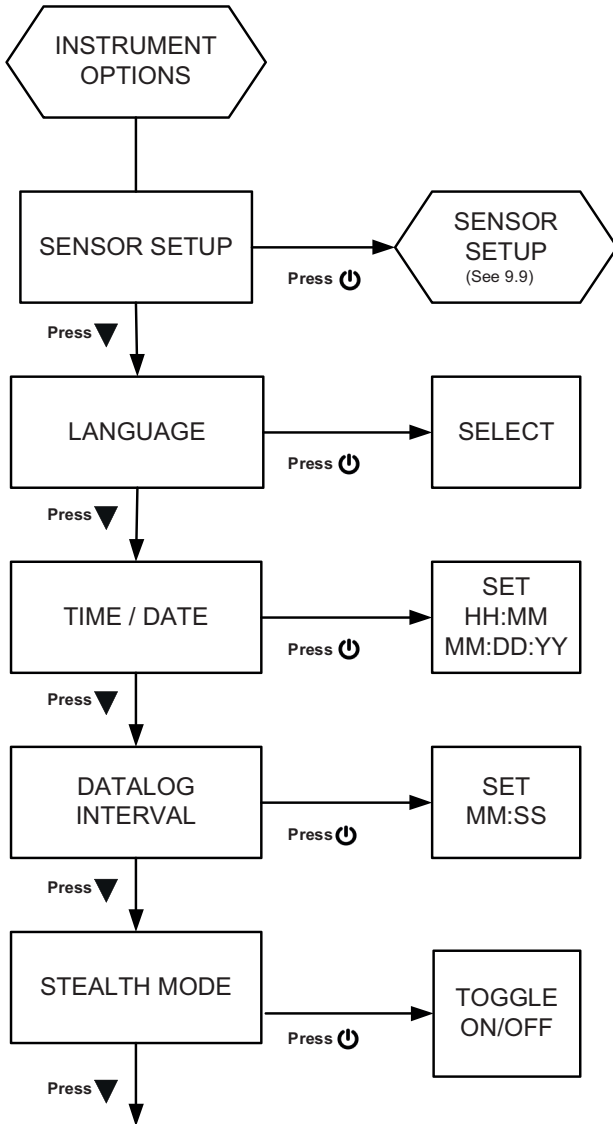

US

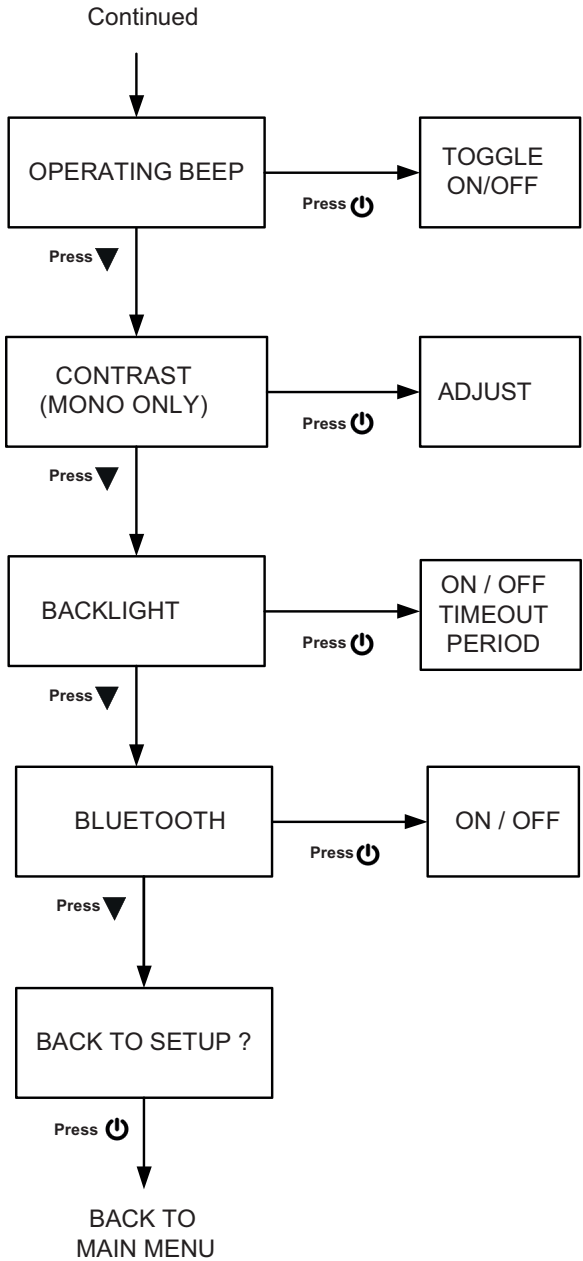

US

9.9 Sensor Setup

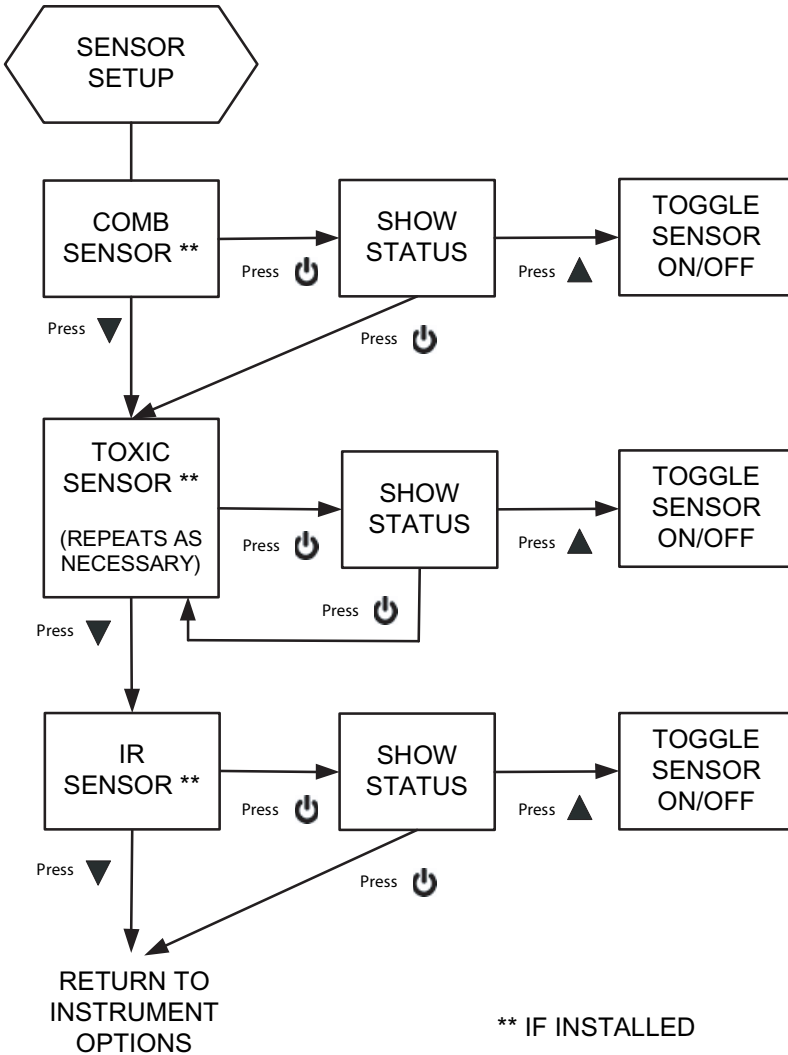

US



## 10 Changeable Feature Summary

Feature	Initial Setting	Setup Path to Change this Setting	Change with MSA link?	Change via Bluetooth?
Setup Password	672	-	Yes	No
Vibrating Alarm	ON	ALARM OPTIONS	Yes	Yes
Horn Alarm	ON	ALARM OPTIONS	Yes	Yes
LED Alarm	ON	ALARM OPTIONS	Yes	Yes
Safe LED (green)	ON	-	Yes	No
Operating Beep (alarm LEDs & horn)	OFF	INSTRUMENT OPTIONS	Yes	No
Stealth	OFF	INSTRUMENT OPTIONS	No	No
MotionAlert - Access	Allowed	ALARM OPTIONS	No	Yes
MotionAlert	OFF	Use ▼ button from MEASURE page	No	Yes
Sensor Alarm Levels		ALARM OPTIONS / SENSOR ALARM SETUP	Yes	Yes
Enable / Disable High & Low Alarms	Enabled	-	Yes	Yes
Turn Sensors ON / OFF	ON	INSTRUMENT OPTIONS / SENSOR SETUP	Yes	No
Show Peak	ON	-	Yes	No
Show STEL, TWA	ON	-	Yes	No
Cal Cylinder Setup		CAL OPTIONS	Yes	Yes
Show Last Cal Date	ON	CAL OPTIONS	No	No
Show Cal Due	ON	CAL OPTIONS	Yes	No
Cal Password Required	OFF	CAL OPTIONS	No	No
Backlight	Enabled	-	No	Yes
Backlight Duration	10 s	INSTRUMENT OPTIONS	Yes	Yes
Display Contrast	Factory-set	INSTRUMENT OPTIONS	No	No
Language	User-set	INSTRUMENT OPTIONS	No	Yes
Date, Time	User-set	INSTRUMENT OPTIONS	Yes	Yes
Datalog Interval	3 min	INSTRUMENT OPTIONS	Yes	No
Custom Logo Screen	Factory-set	Certified service center	Yes	No
Device S/N	Factory-set	-	No	No
Company Name	Blank	-	Yes	Yes
Dept./User Name	Blank	-	Yes	Yes
VOC RF ON/OFF	ON	INSTRUMENT OPTIONS	Yes	No
Bump Due ON/OFF	OFF	-	Yes	Yes
Bump Interval	1	-	Yes	Yes
Cal Due Interval	30	INSTRUMENT OPTIONS	Yes	Yes

US

For local MSA contacts, please visit us at [\*\*MSAsafety.com\*\*](http://MSAsafety.com)

*Because every life has a **purpose...***