



EI Tester
MI 3288
Instruction manual
Version 1.2.2, Code No. 20 753 190

Distributor:

Manufacturer:

METREL d.d.
Ljubljanska cesta 77
1354 Horjul
Slovenia
web site: <http://www.metrel.si>
e-mail: metrel@metrel.si



Mark on your equipment certifies that it meets requirements of all subjected EU regulations

© 2021 METREL

The trade names Metrel[®], Smartec[®], Eurotest[®], Auto Sequence[®] are trademarks registered in Europe and other countries.

No part of this publication may be reproduced or utilized in any form or by any means without permission in writing from METREL.

i. About the Instruction manual

- This Instruction manual contains detailed information on the MI 3288, its key features, functionalities and use.
- It is intended for technically qualified personnel responsible for the product and its use.
- Please note that LCD screenshots in this document may differ from the actual instrument screens in details due to firmware variations and modifications.
- Metrel reserve the right to make technical modifications without notice as part of the further development of the product.
- MI 3288 instrument is available in multiple sets with a combination of different accessories and measurement functions. The functionality of an existing set can be expanded by ordering additional accessory and license keys.

See Appendix B– Profiles Selection Table for more information.

Table of contents

1	General description	8
1.1	Features	8
2	Safety and operational considerations	9
2.1	Warnings and notes	9
2.2	Battery and charging of Li-ion battery pack	11
2.2.1	Precharge.....	12
2.2.2	Li – ion battery pack guidelines	14
2.3	Standards applied	15
3	Terms and definitions	16
4	Instrument description	17
4.1	Operator’s panel.....	17
4.2	Connector panel	18
4.2.1	Designation of the Test connector terminals	18
4.3	Back side.....	19
4.3.1	Secure attachment of the strap	21
5	Accessories	22
5.1	Standard set.....	22
5.2	Optional accessories	22
6	Instrument operation	23
6.1	General meaning of keys.....	23
6.2	General meaning of touch gestures	23
6.3	Virtual keyboard	24
6.4	Display and sound.....	25
6.4.1	Battery and time indication	25
6.4.2	Messages.....	25
6.4.3	Sound indication.....	27
6.4.4	Terminal voltage monitor.....	27
6.4.5	Bluetooth.....	28
6.4.6	Help screens	28
7	Main menu	29
7.1	Instruments main menu	29
8	General Settings	30
8.1	Language	31
8.2	Power Save	31
8.3	Date and time	32
8.4	Instrument profiles.....	32
8.5	Settings	33
8.6	Initial Settings	34
8.7	About.....	34
8.8	Auto Sequence® groups	35
8.8.1	Auto Sequence® groups menu	35
8.8.2	Operations in Auto Sequence® groups menu:	35
8.8.3	Selecting a list of Auto Sequences®	36
8.8.4	Deleting a list of Auto Sequences®.....	36
8.9	Workspace manager	37
8.9.1	Workspaces and Exports	37

8.9.2	Workspace Manager main menu	37
8.9.3	Operations with Workspaces.....	38
8.9.4	Operations with Exports	38
8.9.5	Adding a new Workspace.....	39
8.9.6	Opening a Workspace.....	40
8.9.7	Deleting a Workspace / Export.....	40
8.9.8	Importing a Workspace	41
8.9.9	Exporting a Workspace	41
8.10	User accounts	43
8.10.1	Signing in	43
8.10.2	Changing user password, signing out	44
8.10.3	Managing accounts	45
8.10.4	Setting Black-box password.....	47
9	Memory Organizer	48
9.1	Memory Organizer menu.....	48
9.1.1	Measurement statuses	48
9.1.2	Structure items	49
9.1.3	Measurement status indication under the Structure item	49
9.1.4	Operations in Tree menu.....	50
10	Single tests.....	64
10.1	Selection modes.....	64
10.1.1	Single test screens.....	65
10.1.2	Setting parameters and limits of single tests	66
10.1.3	Single test result screen	67
10.1.4	Recall single test result screen.....	68
10.1.5	Single test (Visual Test) screens.....	68
10.1.6	Single test (Visual Test) start screen.....	69
10.1.7	Single test (Visual Test) screen during test.....	70
10.1.8	Single test (Visual Test) result screen.....	71
10.1.9	Single test (Visual Test) memory screen.....	72
11	Tests and Measurements	73
11.1	Visual tests	73
11.2	Voltage and Frequency Measurements [U/f]	75
11.2.1	Voltage Meter	75
11.3	Earth Measurements [Ze and Re]	77
11.3.1	2 – pole measurement.....	77
11.3.2	3 – pole measurement.....	79
11.3.3	4 – pole measurement.....	81
11.3.4	Selective (Iron Clamp) measurement.....	82
11.3.5	2 Clamps measurement	84
11.4	Specific Earth Resistance Measurements[ρ].....	87
11.4.1	General on specific earth	87
11.4.2	Wenner method measurement.....	88
11.4.3	Schlumberger method measurement	90
11.5	Earth Potential [Us]	92
11.5.1	Step and Touch Measurement	93
11.6	DC Resistance [R].....	95
11.6.1	Ω - Meter (200 mA) Measurement.....	96
11.6.2	Ω - Meter (7 mA) Measurement.....	97

11.7	Insulation Resistance Measurement [Riso]	99
11.7.1	Insulation Resistance measurement	100
11.7.2	Diagnostic Test	101
11.7.3	Varistor Test	105
11.8	Current [I]	106
11.8.1	Current Clamp Meter	107
12	Auto Sequences®	108
12.1	Selection of Auto Sequence®	108
12.1.1	Selecting an active Auto Sequence® group in Auto Sequences® menu	108
12.1.2	Searching in Auto Sequences® menu	109
12.1.3	Organization of Auto Sequences® in Auto Sequences® menu	110
12.2	Organization of Auto Sequence®	112
12.2.1	Auto Sequence® view menu	112
12.2.2	Step by step executions of Auto Sequence®	113
12.2.3	Auto Sequence® result screen	114
12.2.4	Auto sequence memory screen	117
13	Communication	118
14	Maintenance	119
14.1	Fuse replacement	119
14.2	Battery pack insertion / replacement	120
14.3	Cleaning	121
14.4	Periodic calibration	121
14.5	Service	121
14.6	Upgrading the instrument	121
15	Technical specifications	122
15.1	Voltage and frequency [U/f]	122
15.1.1	Voltage Meter RMS	122
15.1.2	Frequency	122
15.2	Current [I]	123
15.2.1	Iron (A 1281) and Flex (A 1227, A 1609) current clamp	123
15.3	Earth [Ze]	124
15.3.1	2, 3, 4 - pole	124
15.3.2	Selective (Iron Clamp)	125
15.3.3	2 Clamps	126
15.4	Specific Earth Resistance Measurements [p]	127
15.4.1	Wenner and Schlumberger method	127
15.5	Earth Potential [Us]	128
15.5.1	Step and Touch	128
15.6	DC Resistance [R]	129
15.6.1	Ω - Meter (200mA)	129
15.6.2	Ω - Meter (7mA)	130
15.7	Insulation Resistance Measurement [Riso]	131
15.7.1	Insulation Resistance - (IR, DD, - Test)	131
15.7.2	Varistor test	133
15.8	Influence of the auxiliary electrodes	134
15.9	Influence of low test current through clamps	134
15.10	Influence of noise	135
15.10.1	Digital filtering technique	136
15.11	Sub-results in measurement functions	136

15.12	General data.....	137
Appendix A	– Structure objects	139
Appendix B	– Profiles Selection Table	140
Appendix C	– Functionality and placing of test probes.....	141
Appendix D	– Programming of Auto Sequences® on Metrel ES Manager	145
D.1	Auto Sequence® Editor workspace.....	145
D.2	Managing groups of Auto Sequences®.....	146
D.2.1	Auto Sequences® Name, Description and Image editing	148
D.2.2	Search within selected Auto sequence® group.....	149
D.3	Elements of an Auto Sequence®	149
D.3.1	Auto Sequence® steps.....	149
D.3.2	Single tests.....	149
D.3.3	Flow commands	150
D.3.4	Number of measurement steps	150
D.4	Creating / modifying an Auto Sequence®	150
D.5	Description of flow commands.....	151
D.6	Custom Inspection programming.....	152
D.6.1	Creating and editing Custom Inspections.....	152
D.6.2	Applying Custom Inspections	154

1 General description

1.1 Features

EI (Earth – Insulation) Tester (MI 3288) is a Multi-function, portable battery (Li-ion) test instrument with excellent IP protection **IP54**, intended for: Voltage and frequency measurement (TRMS), Insulation resistance measurement up to 2,5 kV, Earth resistance and impedance, Specific earth resistance, Earth potential and continuity (7 mA, 200 mA) measurement. It is designed and produced with the extensive knowledge and experience acquired through many years of working in this field.

Available functions and features offered by the **MI 3288 Tester**:

- Voltage and frequency measurement up to 1 kV TRMS;
- Earth Impedance or Resistance 2, 3, 4 – pole;
- Selective Earth Impedance (Iron Clamp);
- 2 Clamps measurement;
- Specific Earth Resistance ρ (Wenner, Schlumberger method);
- Earth Potential;
- Insulation measurement from 50 to 2500 V;
- Polarization Index (PI) and Dielectric Absorption ratio (DAR);
- Dielectric Discharge ratio (DD);
- Capacitance measurement;
- Varistor test (Over-voltage Protection Devices);
- Ω - Meter (7 mA and 200 mA);
- Current RMS Measurement;
- Auto Sequence®;
- Visual Test;
- Memory Organizer.

A **4.3" (10.9 cm) colour LCD** display with **touch screen** offers easy-to-read results and all associated parameters. The operation is straightforward and clear to enable the user to operate the instrument without the need for special training (except reading and understanding this Instruction Manual).

Test results can be stored on the instrument. PC software that is supplied as a part of standard set enables transfer of measured results to PC where can be analysed or printed.

MI 3288 EI Tester	according to:
2 – pole	EN 61557 – 5 [<i>Resistance to earth</i>]
3 – pole	IEEE Std 81 – 2012 [<i>Two-point method, Three-point method, Fall-of-potential method</i>]
4 – pole	
2 Clamps	IEEE Std 81 – 2012 [<i>Resistance measurements by clamp-on stakeless method</i>]
Selective (Iron Clamp)	IEEE Std 81 – 2012 [<i>Resistance measurements by FOP/clamp-on method</i>]
Wenner Method	IEEE Std 81 – 2012 [<i>Four-point method (Equally Spaced or Wenner Arrangement); (Unequally Spaced or Schlumberger-Palmer Arrangement)</i>]
Schlumberger Method	
Ω - Meter (200mA)	EN 61557 – 4 [<i>Resistance of earth connection and equipotential bonding</i>]
Insulation Resistance	EN 61557 – 2 [<i>Insulation resistance</i>]

2 Safety and operational considerations

2.1 Warnings and notes

In order to maintain the highest level of operator safety while carrying out various tests and measurements Metrel recommends keeping your **MI 3288** instruments in good condition and undamaged. When using the instrument, consider the following general warnings:

- The  symbol on the test equipment means »Read the Instruction manual with special care for safe operation«. The symbol requires an action!
- If the test equipment is used in a manner not specified in this Instruction manual, the protection provided by the equipment could be impaired!
- Read this Instruction manual carefully, otherwise the use of the test equipment may be dangerous for the operator, the test equipment itself or for the tested object!
- A lethal voltage can exist between the ground electrode under test and a remote ground!
- Do not use the test equipment or any of the accessories if any damage is noticed!
- Consider all generally known precautions in order to avoid risk of electric shock while dealing with hazardous voltages!
- Do not connect the test equipment to a mains voltage different from the one defined on the label adjacent to the mains connector, otherwise it may be damaged.
- Service intervention or adjustment is only allowed to be carried out by competent authorized personnel!
- All normal safety precautions must be taken in order to avoid risk of electric shock while working on electrical installations!
- Do not use the equipment in a wet environment, around explosive gas, vapour.
- Only adequately trained and competent persons may operate the equipment.
- Do not connect any voltage source on GUARD (C1) terminal. It is intended only for connection of GUARD lead.

2 wire test accessory:

- Maximum allowed input voltage between HV+ and HV- test terminals on test connector is 1000 V! (CAT II 1000 V)

4 wire test accessories:

- Maximum allowed input voltage between C1 and C2 or H and E test terminals on test connector is 1000 V! (CAT II 1000 V)
- Maximum allowed input voltage between any other combination of test terminals on test connector is 300 V! (CAT IV 300 V)

Markings on the instrument:



Read the Instruction manual with special care to safety operation«. The symbol requires an action!



Mark on your equipment certifies that it meets requirements of all subjected EU regulations.



■ This equipment should be recycled as electronic waste.



Warnings related to measurement functions:

Working with the instrument

- ❑ Use only standard or optional test accessories supplied by your distributor!
- ❑ Always connect accessories to the test equipment and to the test object before starting measurement. Do not touch test leads or crocodile clips during measurement.
- ❑ Do not touch any conductive parts of equipment under test during the test, risk of electric shock!
- ❑ Make sure that the tested object is disconnected (mains voltage disconnected) and de-energized, before connecting the test leads and starting the measurement!
- ❑ Do not use a current measurement as an indication that a circuit is safe to touch. A voltage measurement is necessary to know if a circuit is hazardous.
- ❑ The instrument automatically discharges tested object after finished measurement.
- ❑ It is recommended to use the GUARD connection when high insulation resistance (>10 GΩ) is measured.
- ❑ **Insulation resistance** measurements shall be performed on de-energized objects, i.e., voltage between test terminals should be lower than **300 Vac** and **50 Vdc**!
- ❑ **Earth resistance** measurements shall be performed on de-energized objects, i.e., voltage between test terminals should be lower than **30 Vac or dc**!
- ❑ **Ohm resistance R7** measurements shall be performed on de-energized objects, i.e., voltage between test terminals should be lower than **10 Vac or dc**!
- ❑ **Ohm resistance R200** measurements shall be performed on de-energized objects, i.e. voltage between test terminals should be lower than **5 Vac or dc**!
- ❑ PASS / FAIL indication is enabled when limit is set to ON. Apply appropriate limit value for evaluation of measurement results.



Warnings related to Batteries:

- ❑ **Use only batteries provided by the manufacturer.**
- ❑ **Never dispose of the batteries in a fire as it may cause them to explode or generate a toxic gas.**
- ❑ **Do not attempt to disassemble, crush or puncture the batteries in any way.**
- ❑ **Do not short circuit or reverse polarity the external contacts on a battery.**
- ❑ **Keep the battery away from children.**
- ❑ **Avoid exposing the battery to excessive shock/impacts or vibration.**
- ❑ **Do not use a damaged battery.**
- ❑ **The Li – ion battery contains safety and protection circuit, which if damaged, may cause the battery to generate heat, rupture or ignite.**
- ❑ **Do not leave a battery on prolonged charge when not in use.**
- ❑ **If a battery has leaking fluids, do not touch any fluids.**
- ❑ **In case of eye contact with fluid, do not rub eyes. Immediately flush eyes thoroughly with water for at least 15 minutes, lifting upper and lower lids, until no evidence of the fluid remains. Seek medical attention.**

2.2 Battery and charging of Li-ion battery pack

The instrument is designed to be powered by rechargeable Li-ion battery pack or with mains supply. The LCD contains an indication of battery condition and the power source (upper left section of LCD). In case the battery is too weak the instrument indicates this as shown in **Figure 2.1**.

Symbol:

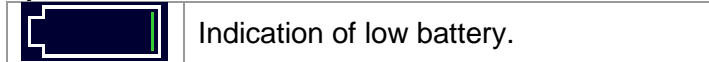

Figure 2.1: Battery test

The battery is charged whenever the power supply is connected to the instrument. The power supply socket is shown in Figure 2.2. Internal circuit controls (CC, CV) charging and assures maximum battery lifetime. Nominal operating time is declared for battery with nominal capacity of 4.4 Ah.



Figure 2.2: Charger socket polarity

The instrument automatically recognizes the connected power supply and begins charging.

Symbol:

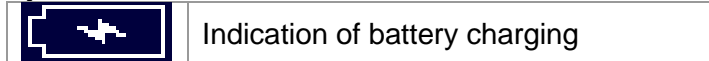

Figure 2.3: Charging indication (animation)

Battery and charging characteristic	Typical
Battery type	18650T22A2S2P 18650T22A2S4P (optional)
Charging mode	CC / CV
Nominal voltage	7.2 V
Rated capacity	4400 mAh (type: 18650T22A2S2P) 8800 mAh (type: 18650T22A2S4P)
Max charging voltage	8.0 V
Max charging current	2.2 A (type: 18650T22A2S2P) 3.0 A (type: 18650T22A2S4P)
Max discharge current	2.5 A
Typical charging time	3 hours (type: 18650T22A2S2P) 4.5 hours (type: 18650T22A2S4P)

Typical charging profile which is also used in this instrument is shown in **Figure 2.4**.

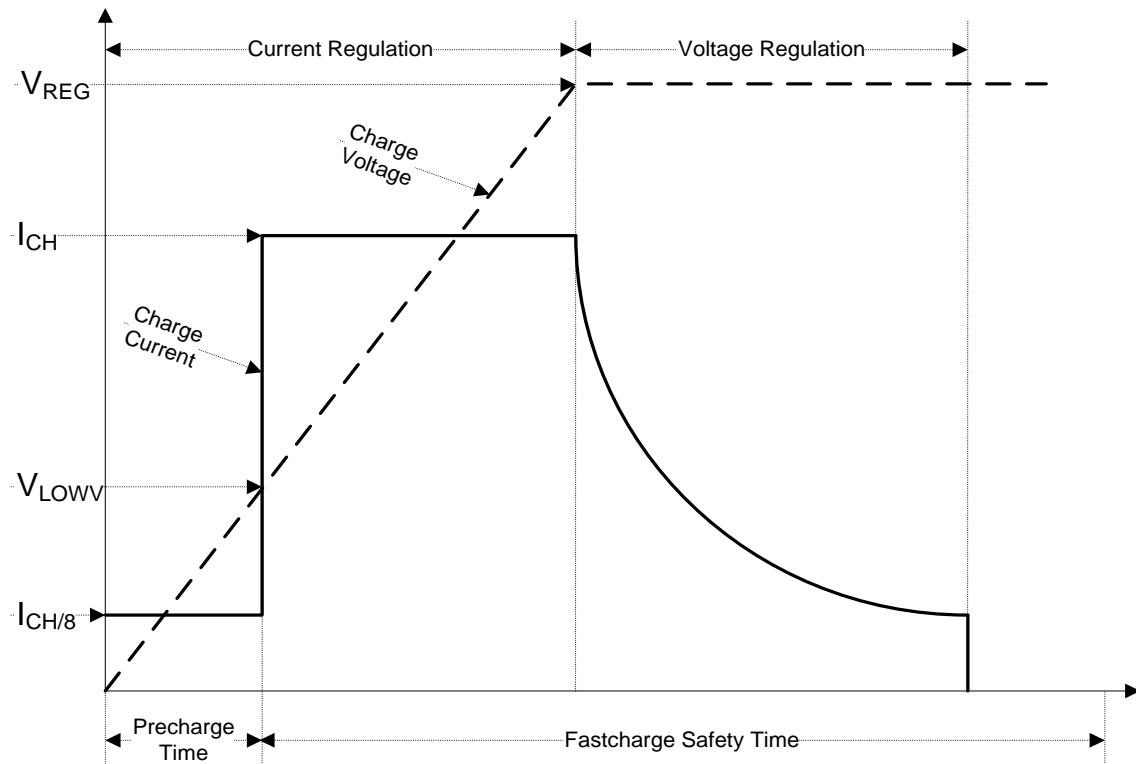

Figure 2.4: Typical charging profile

where:

- V_{REG} Battery charging voltage
- V_{LOWV} Precharge threshold voltage
- I_{CH} Battery charging current
- $I_{CH/8}$ 1/8 of the charging current

2.2.1 Precharge

On power up, if the battery voltage is below the V_{LOWV} threshold, the charger applies 1/8 of the charging current to the battery. The precharge feature is intended to revive deeply discharged battery. If the V_{LOWV} threshold is not reached within 30 minutes of initiating precharge, the charger turns off and a FAULT is indicated.



Figure 2.5: Battery fault indication (charging suspended, timer fault, battery absent)



Figure 2.6: Battery full indication (charging completed)

Note:

- As a safety backup, the charger also provides an internal 5-hour charge timer for fast charge.

Typical charging time is 3 hours (Battery type: 18650T22A2S2P) in the temperature range of 5°C to 60°C.

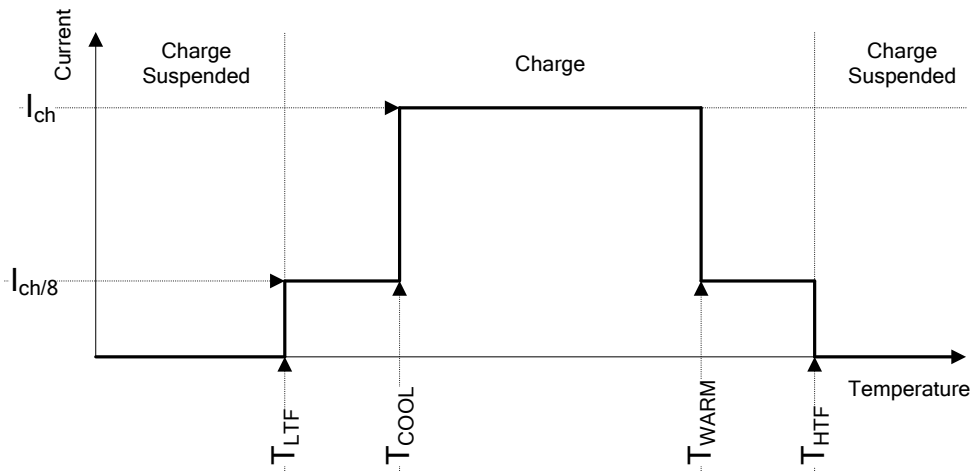

Figure 2.7: Typical charging current vs temperature profile

where:

- T_{LTF} Cold temperature threshold (typ. -15°C)
- T_{COOL} Cool temperature threshold (typ. 0°C)
- T_{WARM} Warm temperature threshold (typ. +60°C)
- T_{HTF} Hot temperature threshold (typ. +75°C)

The charger continuously monitors battery temperature. To initiate a charge cycle, the battery temperature must be within the T_{LTF} to T_{HTF} thresholds. If battery temperature is outside of this range, the controller suspends charge and waits until the battery temperature is within the T_{LTF} to T_{HTF} range.

If the battery temperature is between the T_{LTF} and T_{COOL} thresholds or between the T_{WARM} and T_{HTW} thresholds, charge is automatically reduced to $I_{CH/8}$ (1/8 of the charging current).

2.2.2 Li – ion battery pack guidelines

Li – ion rechargeable battery pack requires routine maintenance and care in their use and handling. Read and follow the guidelines in this Instruction manual to safely use Li – ion battery pack and achieve the maximum battery life cycles.

Do not leave batteries unused for extended periods of time – more than 6 months (self – discharge).

When a battery has been unused for 6 months, check the charge status see chapter **6.4.1 Battery and time indication**. Rechargeable Li – ion battery pack has a limited life and will gradually lose their capacity to hold a charge. As the battery loses capacity, the length of time it will power the product decreases.

Storage:

- ❑ Charge or discharge the instruments battery pack to approximately 50% of capacity before storage.
- ❑ Charge the instrument battery pack to approximately 50% of capacity at least once every 6 months.

Transportation:

- ❑ Always check all applicable local, national, and international regulations before transporting a Li – ion battery pack.



Handling Warnings:

- ❑ **Do not disassemble, crush, or puncture a battery in any way.**
- ❑ **Do not short circuit or reverse polarity the external contacts on a battery.**
- ❑ **Do not dispose of a battery in fire or water.**
- ❑ **Keep the battery away from children.**
- ❑ **Avoid exposing the battery to excessive shock/impacts or vibration.**
- ❑ **Do not use a damaged battery.**
- ❑ **The Li – ion battery contains safety and protection circuit, which if damaged, may cause the battery to generate heat, rupture or ignite.**
- ❑ **Do not leave a battery on prolonged charge when not in use.**
- ❑ **If a battery has leaking fluids, do not touch any fluids.**
- ❑ **In case of eye contact with fluid, do not rub eyes. Immediately flush eyes thoroughly with water for at least 15 minutes, lifting upper and lower lids, until no evidence of the fluid remains. Seek medical attention.**

2.3 Standards applied

The MI 3288 instrument is manufactured and tested in accordance with the following regulations:

Electromagnetic compatibility (EMC)

EN 61326 - 1	Electrical equipment for measurement, control and laboratory use – EMC requirements – Part 1: General requirements
EN 61326 - 2 - 2	Electrical equipment for measurement, control and laboratory use – EMC requirements – Part 2-2: Particular requirements - Test configurations, operational conditions and performance criteria for portable test, measuring and monitoring equipment used in low-voltage distribution systems

Safety (LVD)

EN 61010 - 1	Safety requirements for electrical equipment for measurement, control and laboratory use – Part 1: General requirements
EN 61010 - 2 - 030	Safety requirements for electrical equipment for measurement, control and laboratory use – Part 2-030: Particular requirements for testing and measuring circuits
EN 61010 - 2 - 032	Safety requirements for electrical equipment for measurement, control and laboratory use – Part 2-032: Particular requirements for hand-held and hand-manipulated current sensors for electrical test and measurement.
EN 61010 - 031	Safety requirements for hand-held probe assemblies for electrical measurement and test.

Some further recommendations

EN 61557	Electrical safety in low voltage distribution systems up to 1000 V a.c. and 1500 V d.c. - Equipment for testing, measuring or monitoring of protective measures. Part 1: General requirements Part 2: Insulation resistance Part 4: Resistance of earth connection and equipotential bonding Part 5: Resistance to earth Part 10: Combined measuring equipment
IEEE 81 – 2012	IEEE Guide for Measuring Earth Resistivity, Ground Impedance, and Earth Surface Potentials of a Grounding System.
EN 50522 – 2010	Earthing of power installations exceeding 1 000 V a.c.
IEEE 142 – 2007	IEEE Recommended Practice for Grounding of Industrial and Commercial Power Systems (US).
IEEE 367 – 2012	IEEE Recommended Practice for Determining the Electric Power Station Ground Potential Rise and Induced Voltage from a Power Fault.

Li – ion battery pack

IEC 62133 - 2	Secondary cells and batteries containing alkaline or other non-acid electrolytes - Safety requirements for portable sealed secondary cells, and for batteries made from them, for use in portable applications – Part 2: Lithium systems protection for household and similar uses
----------------------	--

Note about EN and IEC standards:

- Text of this manual contains references to European standards. All standards of EN 6XXXX (e.g. EN 61010) series are equivalent to IEC standards with the same number (e.g. IEC 61010) and differ only in amended parts required by European harmonization procedure.

3 Terms and definitions

For the purposes of this document and instrument MI 3288, the following definitions apply.

Index:	Unit:	Description:
Re	[Ω]	Earth resistance of complete system.
Ze	[Ω]	Earth impedance of complete system.
Rp	[Ω]	Auxiliary potential probe impedance.
Rc	[Ω]	Auxiliary current probe impedance.
Ie	[A]	System current or generator current.
f	[Hz]	Test frequency.
Ic	[A]	Iron clamp current.
Zsel	[Ω]	Earth impedance of measured branch.
ρ	[$\Omega\text{m} / \Omega\text{ft}$]	Specific earth resistance [resistivity].
R	[Ω]	Resistance [DC current].
I_{dc}	[A]	DC current.
R+	[Ω]	Low Ohm resistance [positive current direction].
R-	[Ω]	Low Ohm resistance [negative current direction].
Riso	[Ω]	Insulation resistance
Um	[V]	Measured test voltage.
I	[A]	Measured leaking current or clamp current
C	[F]	Measured capacitance.
R1-5	[Ω]	Insulation resistance 1 to 5 [different time of measurement].
U1-5	[V]	Measured test voltage 1 to 5 [different time of measurement].
DAR	[]	Dielectric Absorption Ratio.
PI	[]	Polarization Index.
DD	[]	Dielectric Discharge index.
U_{dc}	[V]	Breakdown voltage DC in varistor test measurement
U_{ac}	[V]	Calculated breakdown AC voltage in varistor test measurement
U	[V]	Measured voltage.
Freq	[Hz]	Measured frequency.
f	[Hz]	Measured frequency.
R	[m/ft]	Distance between E and auxiliary earth rod H.
r	[m/ft]	Distance between E and S probe.
I_{gen}	[A]	Generator current.
Us	[V]	Calculated step, touch voltage.
I_{fault}	[A]	Maximum expected fault current.

Notes (acc.to EN 50522-2010):

- **Resistance to earth, R_E** - real part of the impedance to earth.
- **Impedance to earth, Z_E** - impedance at a given frequency between a specified point in a system or in an installation or in equipment and reference earth.

The impedance to earth is determined by the directly connected earth electrodes and also by connected overhead earth wires and wires buried in earth of overhead lines, by connected cables with earth electrode effect and by other earthing systems which are conductively connected to the relevant earthing system by conductive cable sheaths, shields, PEN conductors or in another way.

4 Instrument description

4.1 Operator's panel

The operator's panel is shown in Figure 4.1 below.

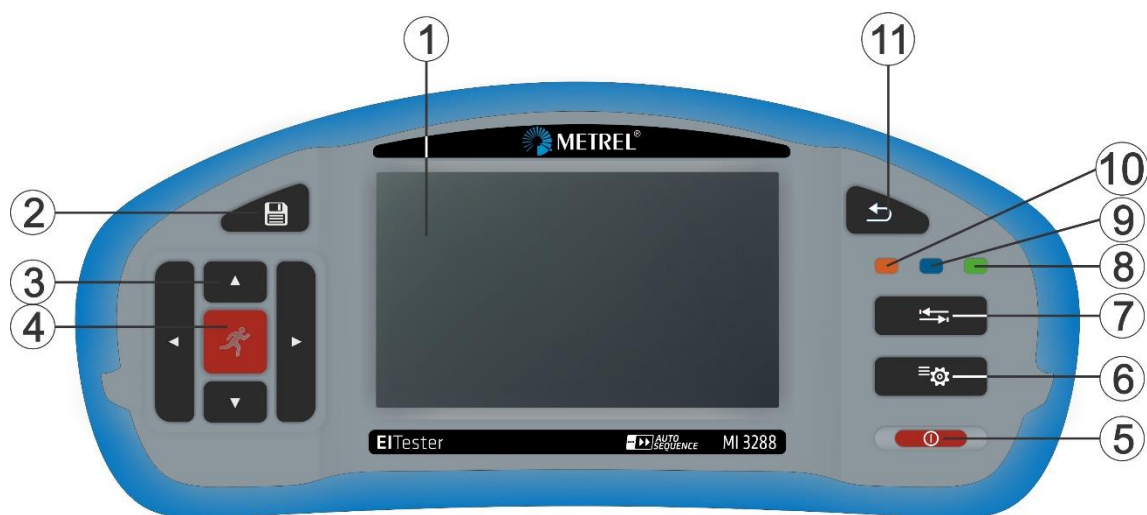

Figure 4.1: The operator's panel

1	Colour TFT display with touch screen
2	SAVE Stores actual measurement result(s)
3	CURSOR Navigate in menus
4	RUN Start / stop selected measurement. Enter selected menu or option. View available values for selected parameter / limit.
5	ON / OFF Switch instrument on / off. The instrument automatically switches off after 10 minutes of idle state (no key pressed or any touchscreen activity) Press and hold the key for 5 s to switch off the instrument.
6	GENERAL SETTINGS Enter General settings menu.
7	OPTIONS Show detailed view of options.
8	MEMORY ORGANIZER shortcut Shortcut key to enter Memory organizer menu.
9	SINGLE TESTS shortcut Shortcut key to enter Single Tests menu.
10	AUTO SEQUENCES® shortcut Shortcut key to enter Auto Sequences® menu.
11	ESC Back to previous menu.

4.2 Connector panel

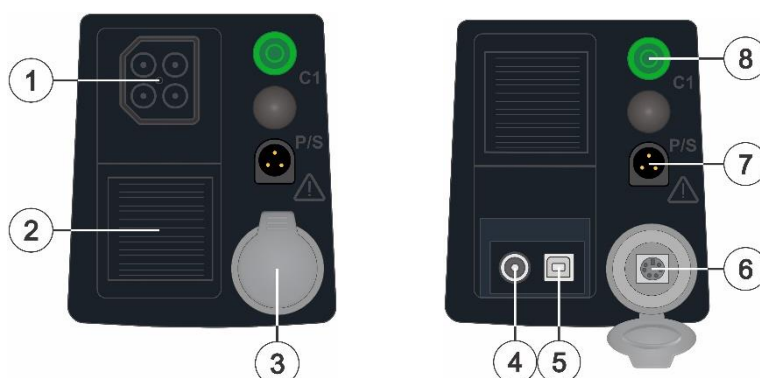



Figure 4.2: Connector panel

1	Test connector
2	Protection cover
3	Protection cover – PS/2 communication port
4	Charger socket 
5	USB communication port Communication with PC USB port
6	PS/2 communication port Communication with PC RS232 serial port
7	P/S input Active current clamps measuring terminal
8	GUARD (C1) Guard input terminal.



Warnings!

- Do not connect any voltage source on GUARD (C1) terminal. It is intended only for connection of GUARD lead.
- Use original test accessories only!
- Maximum short-term voltage of external power supply adapter is 14 V!

4.2.1 Designation of the Test connector terminals

2-wire test accessory (Insulation resistance, Voltage measurement, DC Resistance (2-wire)):

- | | |
|---|--|
| <input type="checkbox"/> HV+ (red) | - positive high voltage output terminal
- positive voltage input terminal
- DC resistance terminal |
| <input type="checkbox"/> HV- (black) | - negative high voltage output terminal
- negative voltage input terminal
- DC resistance terminal |

4-wire test accessory (Earth measurements, Step and Touch voltage):

<input type="checkbox"/> E (blue)	- terminal for the earth electrode
<input type="checkbox"/> ES (red)	- terminal for the probe placed nearest to the earth electrode
<input type="checkbox"/> S (green)	- terminal for a probe
<input type="checkbox"/> H (black)	- terminal for the auxiliary earth electrode

4-wire test accessory (DC Resistance 4-wire):

<input type="checkbox"/> C1 (red)	- current terminal
<input type="checkbox"/> P1 (black)	- potential terminal
<input type="checkbox"/> P2 (black)	- potential terminal
<input type="checkbox"/> C2 (red)	- current terminal

**Warnings!****2 wire test accessory:**

- Maximum allowed input voltage between HV+ and HV- test terminals on test connector is 1000 V! (CAT II 1000 V)**

4 wire test accessories:

- Maximum allowed input voltage between C1 and C2 or H and E test terminals on test connector is 1000 V! (CAT II 1000V)**
- Maximum allowed input voltage between any other combination of test terminals on test connector is 300 V! (CAT IV 300 V)**

4.3 Back side

Figure 4.3: Back view

1	Battery / fuse compartment cover
2	Fixing screws for battery / fuse compartment cover
3	Back panel information label

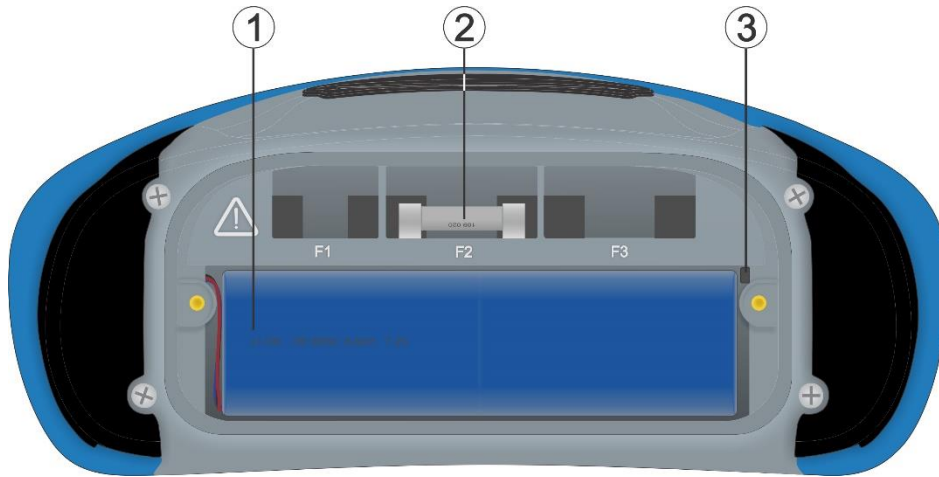

Figure 4.4: Battery and fuse compartment

- | | |
|-----------------------|--|
| 1 Li-ion battery pack | Type: 4400 mAh (18650T22A2S2P)
Type: 8800 mAh (18650T22A2S4P) |
| 2 Fuse F2 | FF 2 A / 1000 V (breaking capacity 50 kA) |

3 SD card slot

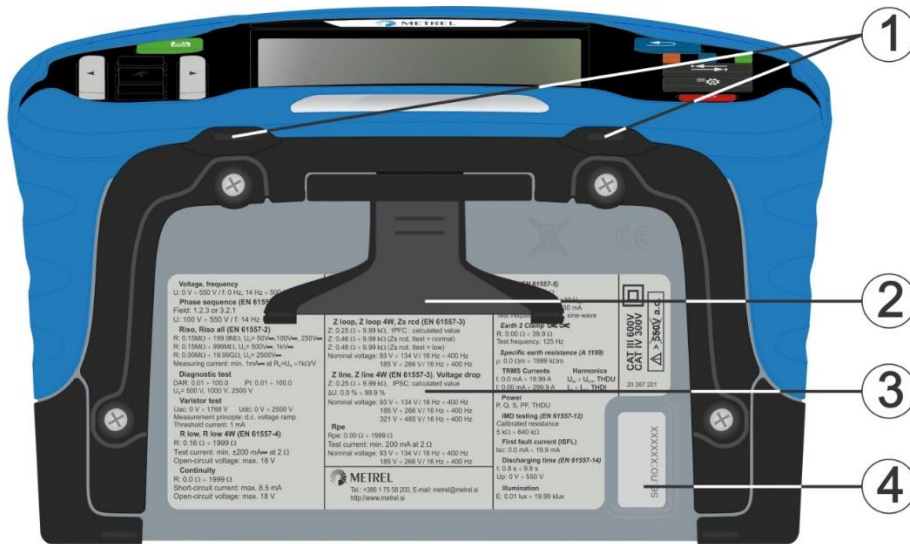
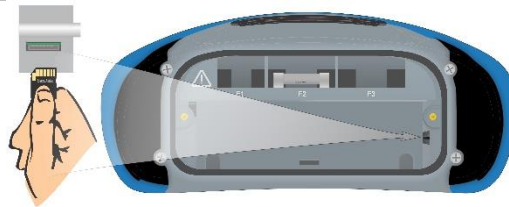

Figure 4.5: Bottom view

- | | |
|---|--------------------------|
| 1 | Neck belt openings |
| 2 | Stand for desktop use |
| 3 | Bottom information label |
| 4 | Serial number label |

4.3.1 Secure attachment of the strap

You can choose between two methods:

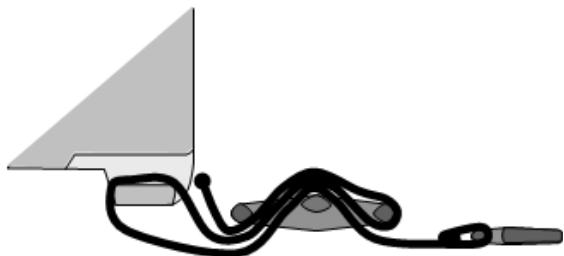

Figure 4.6: First method

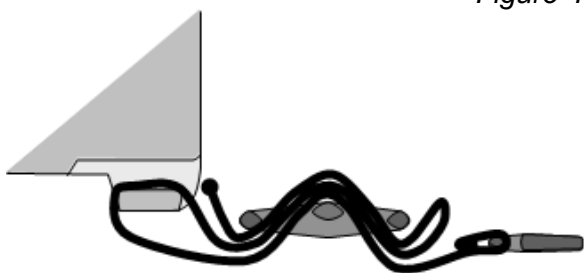

Figure 4.7: Alternative method

Please perform a periodical check of the attachment.

5 Accessories

The accessories consist of standard and optional accessories. Optional accessories can be delivered upon request. See *attached* list for standard configuration and options or contact your distributor or see the METREL home page: <http://www.metrel.si>.

MI 3288 tester is available in multiple sets with a combination of different accessories and measurement functions. The functionality of an existing set can be expanded by ordering additional accessories and license keys.

5.1 Standard set

- ❑ Instrument MI 3288
- ❑ Soft carrying bag and set of carrying straps
- ❑ 2.5 kV test lead, 2 x 1.5 m
- ❑ Earth test set, 4 wire
- ❑ Test lead 1.5 m, 1 pc (green)
- ❑ Test probe, 2 pcs (black, red)
- ❑ Crocodile clips, 4 pcs (black, blue, red, green)
- ❑ USB cable
- ❑ Li-ion battery pack, 7.2 V, 4400 mAh (Type: 18650T22A2S2P)
- ❑ Power supply adapter 12 V, 3 A (Type: CGSW-1203000)
- ❑ PC SW Metrel ES Manager
- ❑ Instruction manual
- ❑ Calibration certificate

5.2 Optional accessories

See the attached sheet for a list of optional accessories and licence keys that are available on request from your distributor.

6 Instrument operation

The MI 3288 instrument can be manipulated via a keypad or touch screen.

6.1 General meaning of keys



Cursor keys are used to:

- select appropriate option.



Run key is used to:

- confirm selected option;
- start and stop measurements;



Escape key is used to:

- return to previous menu without changes;
- abort measurements.



Option key is used to:

- expand column in control panel.



Save key is used to:

- store test results.



Auto Sequences® key is used as:

- shortcut key to enter Auto Sequences® menu.



Single Tests key is used as:

- shortcut key to enter Single Tests menu.



Memory Organizer key is used as:

- shortcut key to enter Memory Organizer menu.



General Settings key is used to:

- enter General Settings menu.



On / Off key is used to:

- switch On / Off the instrument;
- switch Off the instrument if pressed and held for 5 s.

6.2 General meaning of touch gestures



Tap (briefly touch surface with fingertip) is used to:

- select appropriate option;
- confirm selected option;
- start and stop measurements.



Swipe (press, move, lift) up/ down is used to:

- scroll content in same level;
- navigate between views in same level.

**long**

Long press (touch surface with fingertip for at least 1 s) is used to:

- ❑ select additional keys (virtual keyboard);
- ❑ select test or measurement using cross selector.



Tap Escape icon is used to:

- ❑ return to previous menu without changes;
- ❑ abort measurements.

6.3 Virtual keyboard

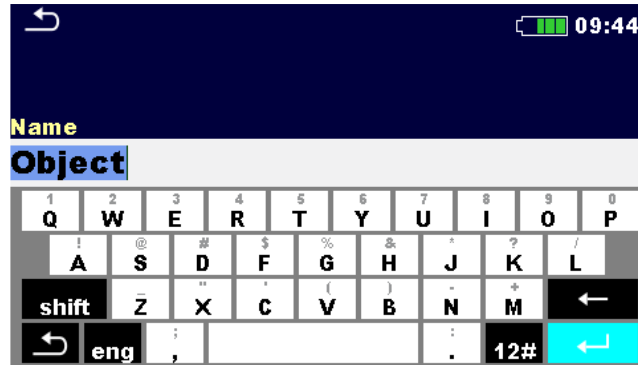

Figure 6.1: Virtual keyboard

shift

Toggle case between lowercase and uppercase.
Active only when alphabetic characters' keyboard layout selected.



Backspace
Clears last character or all characters if selected
(If held for 2 s, all characters are selected).



Enter confirms new text.

12#

Activates numeric / symbols layout.

ABC

Activates alphabetic characters.

eng

English keyboard layout.

GR

Greek keyboard layout.

RU

Russian keyboard layout.



Returns to the previous menu without changes.

6.4 Display and sound

6.4.1 Battery and time indication

The battery indication indicates the charge condition of battery and connection of external charger.



Battery capacity indication.



Low battery. Recharge the battery cells.



Battery is full.



Battery fault indication.



Charging in progress (if power supply adapter is connected and battery inserted).

08:26

Time indication (hh:mm).

6.4.2 Messages

In the message field warnings and messages are displayed.



Conditions on the input terminals allow starting the measurement; consider other displayed warnings and messages.



Conditions on the input terminals do not allow starting the measurement, consider displayed warnings and messages.



Proceeds to next step.



Repeats the measurement.
Displayed result of a single test will not be stored.



Stop the measurement.



















Result(s) can be stored.



Add / view comment.



Opens menu for changing parameters and limits.

	Opens help screen.
	Views results of measurement.
	Starts test leads compensation in Ω - Meter (200 mA and 7 mA) measurement.
	Search in Memory Organizer / Auto Sequences® menu.
	Pass ticker in Visual test.
	Fail ticker in Visual test.
	Clear ticker in Visual test.
	Checked ticker in Visual test.
	Expands control panel / open more options.
	Warning! High voltage is applied to the test terminals. <i>Limit [> 50 Vrms on test terminals].</i>
	The measuring range of the instrument is exceeded. Measurement will not be started or displayed!
	High electrical noise was detected during measurement. Results may be impaired. <i>Limit [Noise frequency is close (± 10 %) to the test frequency].</i>
	Measurement is running, consider displayed warnings.
	High impedance to earth of test probes. <i>See chapter 15.8 Influence of the auxiliary electrodes.</i>
	High impedance of current probe Rc. <i>See chapter 15.8 Influence of the auxiliary electrodes.</i>
	High impedance of current probe Rp. <i>See chapter 15.8 Influence of the auxiliary electrodes.</i>
	Test leads resistance in Ω - Meter (200 mA and 7 mA) measurement is not compensated. <i>Limit [Lead compensation < 5 Ω].</i>



Test leads resistance in Ω - Meter (200 mA and 7 mA) measurement is compensated.



Fuse F2 is broken.



Low test current through Iron or Flex clamps. Results may be impaired. See chapter **15.9 Influence of low test current through clamps**.



H(C1), S(P1), ES(P2) or E(C2) terminal is not connected to the instrument or too high resistance is detected.

Limit

With the low limit the user is allowed to set the limit resistance, current or voltage value. Measured resistance, current or voltage is compared against the limit. Result is validated only if it is within the given limit. Limit indication is shown in the test parameter window.

Message window:



Measurement result is inside pre-set limits (PASS).



Measurement result is out of pre-set limits (FAIL).



Measurement is aborted. Consider displayed warnings and messages.

Note:

- Pass / Fail indication is only displayed if limit is set.**

6.4.3 Sound indication

Continuous sound	Measured current value I_{dc} in Ω - Meter (7 mA) measurement is higher or equal to 5.0 mA.
------------------	--

6.4.4 Terminal voltage monitor

The terminal voltage monitor displays on-line the voltages on the test terminals.

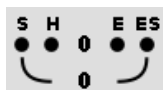

4-wire test terminal indication in Earth, Specific, Potential measurements.

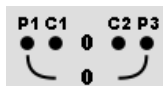

4-wire test terminal indication in DC Resistance (R200, $\mu\Omega$) measurements.

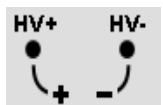

2-wire test terminal indication in Insulation Resistance (ISO, Var), 2-wire DC Resistance (R200, R7) and Voltage measurements.

Display range terminal voltage monitor:

HV+ - HV-.....	0 V ... >1 kV
C1(H) - C2(E).....	0 V ... >1 kV
P1(S) - P2(ES).....	0 V ... >70 V
Insulation measurement group (Riso)	

HV+ - HV-..... 0 V ... >2999 kV

6.4.5 Bluetooth



Bluetooth communication inactive.



Bluetooth communication active.

6.4.6 Help screens



Opens help screen.

Help menus are available in all functions. The Help menu contains schematic diagrams for illustrating proper connection of the instrument to the test object. After selecting the measurement, you want to perform, press the HELP key in order to view the associated Help menu.



on



Selects next / previous help screen.



Exits help menu.

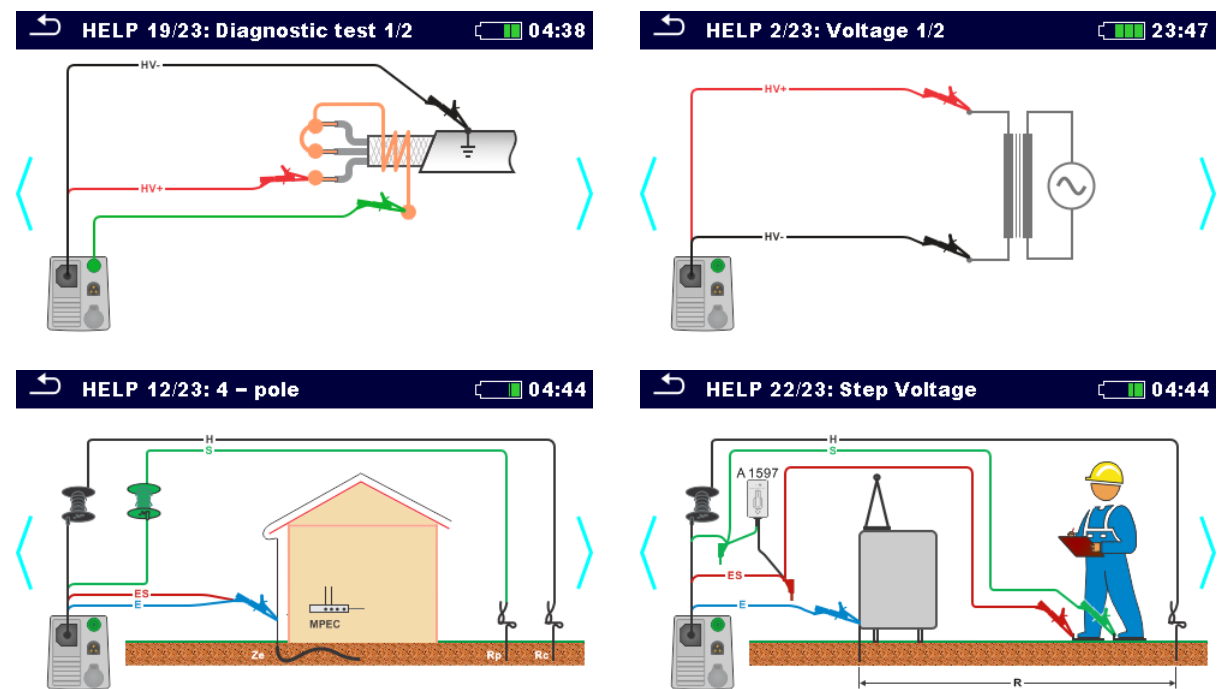

Figure 6.2: Examples of help screens

7 Main menu

7.1 Instruments main menu

From the Main menu different main operation menus can be selected.

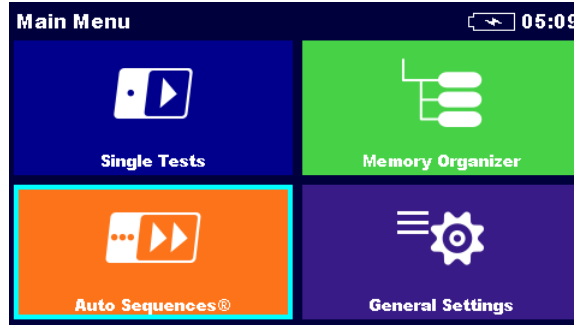

Figure 7.1: Main menu

Options in main menu:



Single Tests

Menu with single tests, see chapter **11 Tests and Measurements** for more information.



Auto Sequences®

Menu with customized test sequences, see chapter **12 Auto Sequences®** for more information.



Memory Organizer

Menu for working with and documentation of test data, see chapter **9 Memory Organizer** for more information.



General Settings

Menu for setup of the instrument, see chapter **8 General Settings** for more information.

8 General Settings

In the **General settings** menu general parameters and settings of the instrument can be viewed or set.

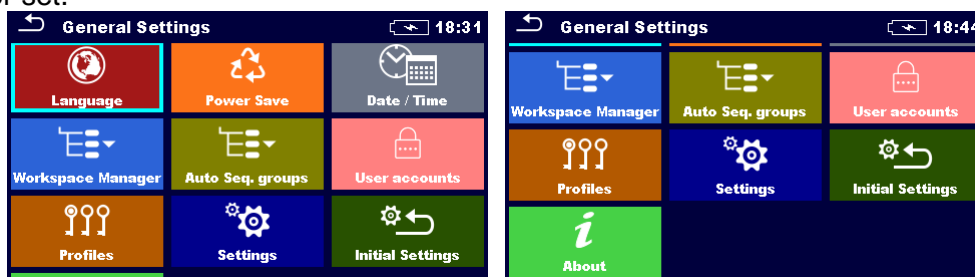

Figure 8.1: General settings menu

Options in General Settings menu:



Language

Instrument language selection. Refer to chapter **8.1 Language** for more information.



Power Save

Brightness of LCD, enabling/disabling Bluetooth communication. Refer to chapter **8.2 Power Save** for more information.



Date /Time

Instruments Date and time. Refer to chapter **8.3 Date and time** for more information.



Workspace Manager

Manipulation with project files. Refer to chapter **8.9 Workspace manager** for more information.



Auto Sequence® groups

Manipulation with lists of Auto Sequences®. Refer to chapter **8.8 Auto Sequence® groups** for more information.

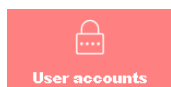

User accounts

User accounts settings. Refer to chapter **8.10 User accounts** for more information.



Instrument Profile

Selection of available instrument profiles. Refer to chapter **8.4 Instrument profiles** for more information.



Settings

Settings of different system / measuring parameters. Refer to chapter **8.5 Settings** for more information.



Initial Settings

Factory settings. Refer to chapter **8.6 Initial Settings** for more information.



About

Instrument info. Refer to chapter **8.7 About** for more information.

8.1 Language

In this menu the language of the instrument can be set.



Figure 8.2: Language menu

8.2 Power Save

In this menu different options for decreasing power consumption can be set.

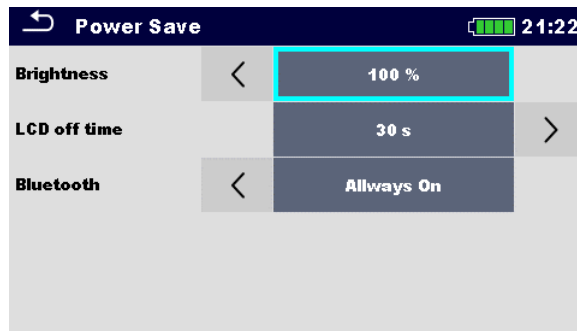

Figure 8.3: Power save menu

Brightness	Setting level of LCD brightness level.
LCD off time	Setting LCD off after set time interval. LCD is switched on after pressing any key or touching the LCD.
Bluetooth	Always On: Bluetooth module is ready to communicate. Save mode: Bluetooth module is set to sleep mode and is not functioning.

8.3 Date and time

In this menu the date and time of the instrument can be set.

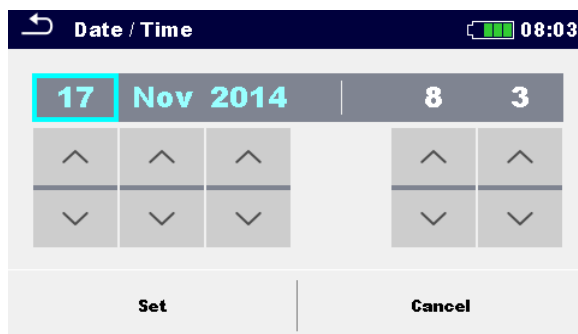

Figure 8.4: Setting date and time

8.4 Instrument profiles

In this menu the instrument profile can be selected from the available ones.

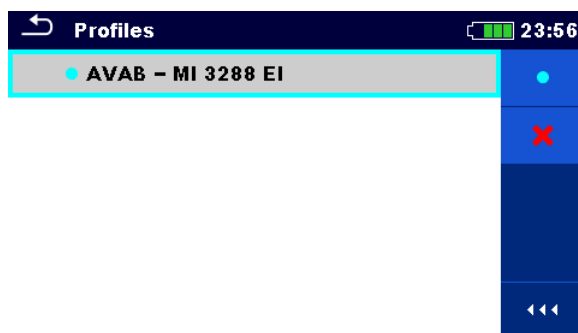

Figure 8.5: Instrument profiles menu

The instrument uses different specific system and measuring settings regarding to the scope of work or country it is used. These specific settings are stored in instrument profiles.

By default, each instrument has at least one profile activated. Proper licence keys must be obtained to add more profiles to the instruments.

If different profiles are available, they can be selected in this menu. For more information, refer to chapter **Appendix B – Profiles Selection Table**.

Options



Loads the selected profile. The instrument will restart automatically with new profile loaded.



Deletes the selected profile.

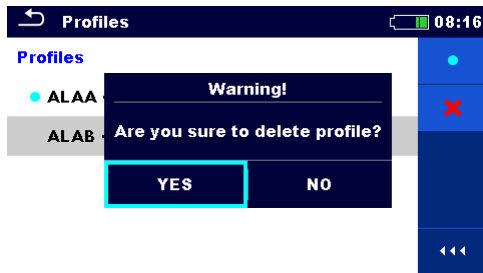

Before deleting the selected profile, user is asked for confirmation.



Expands control panel / open more options.

8.5 Settings

In this menu different general parameters can be set.

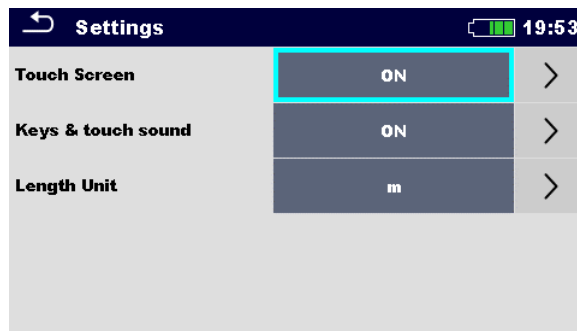

Figure 8.6: Settings menu

	Available selection	Description
Touch screen	[ON, OFF]	Enables / disables operation with touch screen.
Keys & touch sound	[ON, OFF]	Enables / disables sound when using keys and touch screen.
Length Unit	[m, ft]	Length unit for specific earth resistance and potential measurement.

8.6 Initial Settings

In this menu the instrument settings, measurement parameters and limits can be set to initial (factory) values.

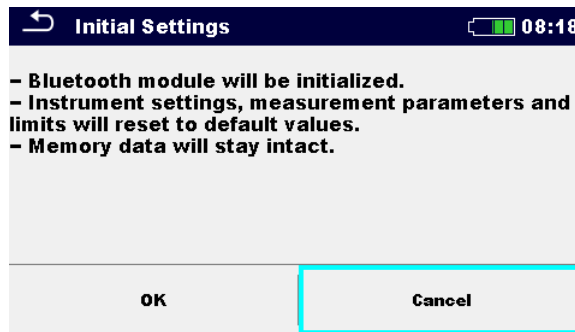

Figure 8.7: Initial settings menu

Warning:

Following customized settings will be lost when setting the instruments to initial settings:

- Measurement limits and parameters.
- Parameters and settings in General settings menu.
- Applying the initial settings will re-boot the instrument.

Notes:

Following customized settings will stay:

- Profile settings.
- Data in memory.

8.7 About

In this menu instrument data (name, version, serial number and date of calibration) can be viewed.

About	
Name	MI 3288 EI Tester
S/N	33333333
FW version	1.3.4.2fcc6527 - AVAB
HW version	1.0
Date of calibration	01.Jan.2001
(C) Metrel d.d., 2020, www.metrel.si	

Figure 8.8: Instrument info screen

8.8 Auto Sequence® groups

The Auto Sequences® in MI 3288 can be organized in lists of Auto Sequences®. In a list, a group of similar Auto Sequences® is stored. The Auto Sequence® groups menu is intended to manage with different lists of Auto Sequences® that are stored on the microSD card.

8.8.1 Auto Sequence® groups menu

In Auto Sequence® groups menu, lists of Auto Sequences® are displayed. Only one list can be opened in the instrument at the same time. The list selected in the Auto Sequence® groups menu will be opened in the Auto Sequence® main menu.

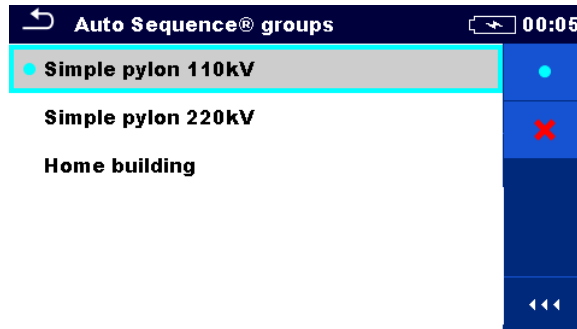

Figure 8.9: Auto Sequence® groups menu

8.8.2 Operations in Auto Sequence® groups menu:

Options



Opens the selected list of Auto Sequences®. Previously selected list of Auto Sequences® will be closed automatically. Refer to chapter **8.8.3 Selecting a list of Auto Sequences®** for more information.



Deletes the selected list of Auto Sequences®. Refer to chapter **8.8.4 Deleting a list of Auto Sequences®** for more information.



Opens options in control panel / expands column.

8.8.3 Selecting a list of Auto Sequences®

Procedure

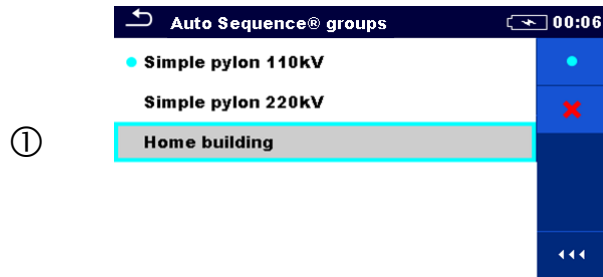

A list of Auto Sequences® can be selected from the Auto Sequence® groups menu.



Enters option for selecting a list.

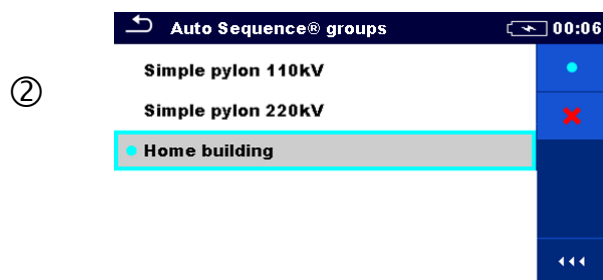

Selected list of Auto Sequences® is marked with a blue dot.

Note:
Previously selected list of Auto Sequences® is closed automatically.

8.8.4 Deleting a list of Auto Sequences®

Procedure

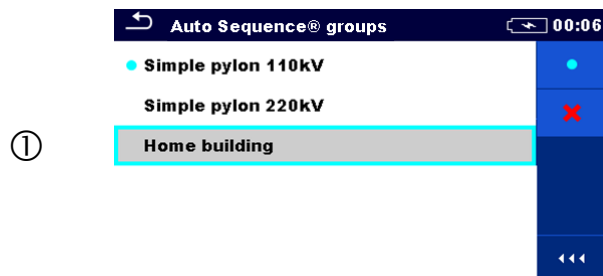

A list of Auto Sequences® to be deleted can be selected from the Auto Sequence® groups menu.



Enters option for deleting a list.

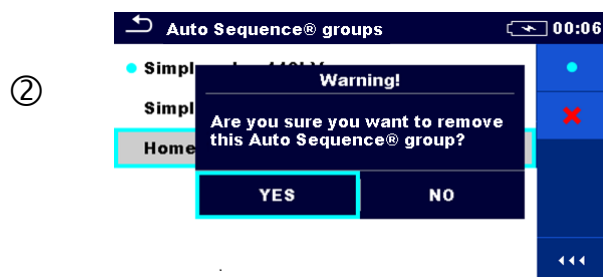

Before deleting the selected list of Auto Sequences®, the user is asked for confirmation.



8.9 Workspace manager

The Workspace Manager is intended to manage with different Workspaces and Exports that are stored into internal data memory.

8.9.1 Workspaces and Exports

The works with MI 3288 can be organized and structured with help of Workspaces and Exports. Exports and Workspaces contain all relevant data (measurements, parameters, limits, structure objects) of an individual work.

Workspaces are stored on internal data memory on directory WORKSPACES, while Exports are stored on directory EXPORTS. Export files can be read by Metrel applications that run on other devices. Exports are suitable for making backups of important works. To work on the instrument an Export should be imported first from the list of Exports and converted to a Workspace. To be stored as Export data a Workspace should be exported first from the list of Workspaces and converted to an Export.

8.9.2 Workspace Manager main menu

In Workspace manager Workspaces and Exports are displayed in two separated lists.

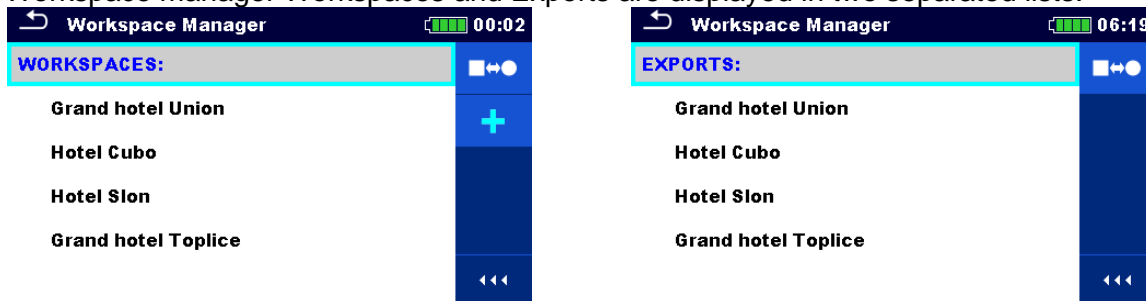

Figure 8.10: Workspace manager menu

Options

	List of Workspaces.
	Displays a list of Exports.
	Adds a new Workspace. Refer to chapter 8.9.5 Adding a new Workspace for more information.
	List of Exports.



Displays a list of Workspaces.

8.9.3 Operations with Workspaces

Only one Workspace can be opened in the instrument at the same time. The Workspace selected in the Workspace Manager will be opened in the Memory Organizer.

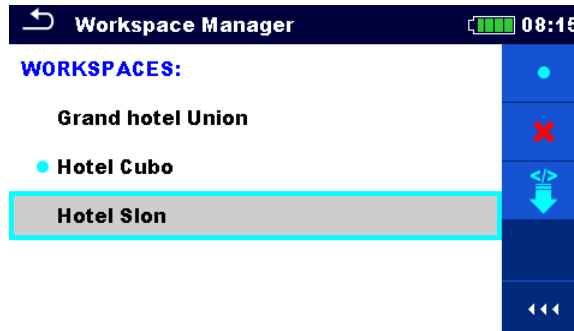

Figure 8.11: Workspaces menu

Options



Marks the opened Workspace in Memory Organizer.
Opens the selected Workspace in Memory Organizer.
Refer to chapter **8.9.6 Opening a Workspace** for more information.



Deletes the selected Workspace.
Refer to chapter **8.9.7 Deleting a Workspace / Export** for more information.



Adds a new Workspace.
Refer to chapter **8.9.5 Adding a new Workspace** for more information.



Exports a Workspace to an Export.
Refer to **8.9.9 Exporting a Workspace** for more information.

8.9.4 Operations with Exports



Figure 8.12: Workspace manager Exports menu

Options



Deletes the selected Export.
Refer to chapter **8.9.7 Deleting a Workspace / Export** for more information.



Imports a new Workspace from Export.
Refer to **8.9.8 Importing a Workspace** for more information.

8.9.5 Adding a new Workspace
Procedure

①

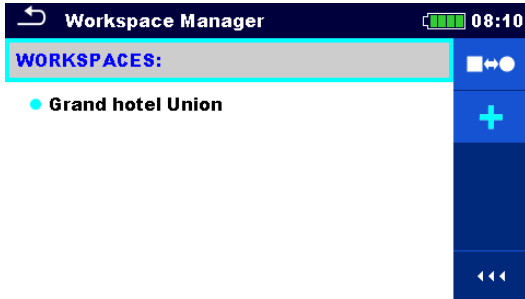

New Workspaces can be added from the Workspace Manager screen.



Enters option for adding a new Workspace.

②

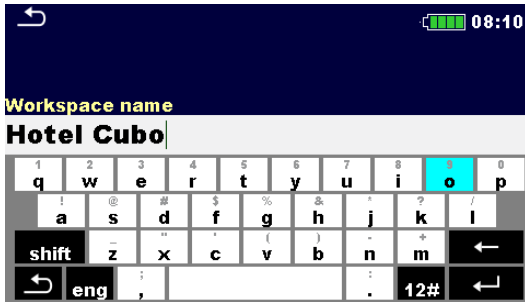

Keypad for entering name of a new Workspace is displayed after selecting New.

③

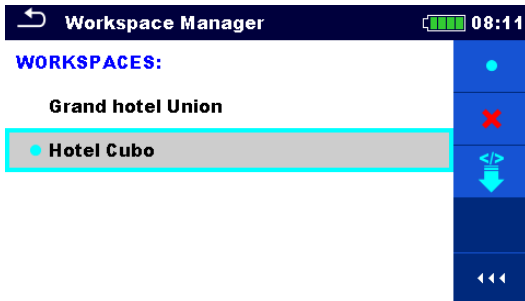

After confirmation a new Workspace is added in the list in Main Workspace Manager menu.

8.9.6 Opening a Workspace Procedure



Workspace can be selected from a list in Workspace manager screen.



Opens a Workspace in Workspace manager.



The opened Workspace is marked with a blue dot. The previously opened Workspace will close automatically.

8.9.7 Deleting a Workspace / Export Procedure



Workspace / Export to be deleted should be selected from the list of Workspaces / Exports. Opened workspace can't be deleted.



Enters option for deleting a Workspace / Export.

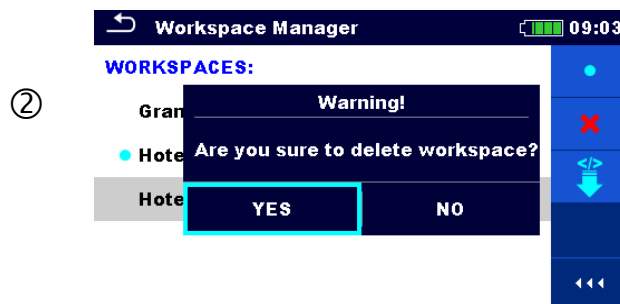

Before deleting the selected Workspace / Export the user is asked for confirmation.

③

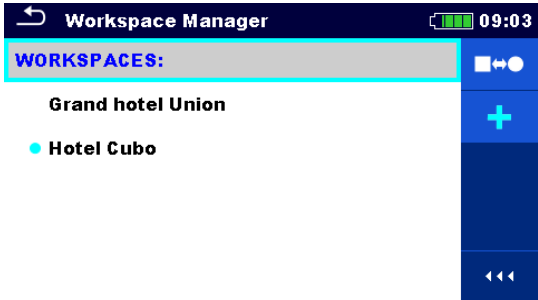

Workspace / Export is removed from the Workspace / Export list.

8.9.8 Importing a Workspace

①

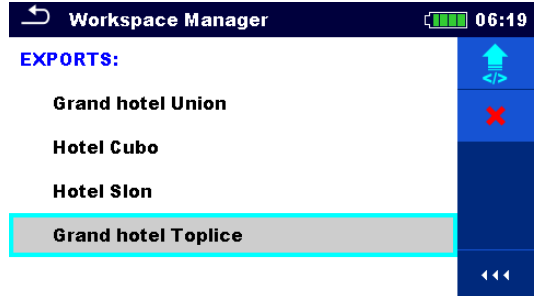

Select an Export file to be imported from Workspace Manager Export list.



Enters option Import.

②

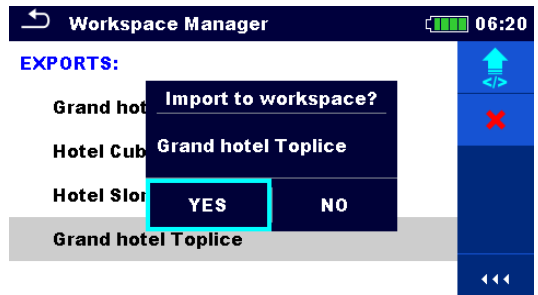

Before the import of the selected file the user is asked for confirmation.

③



The Imported Export file is added to the list of Workspaces.
Note:
 If a Workspace with the same name already exists the name of the imported Workspace will be changed (name_001, name_002, name_003...).

8.9.9 Exporting a Workspace

①

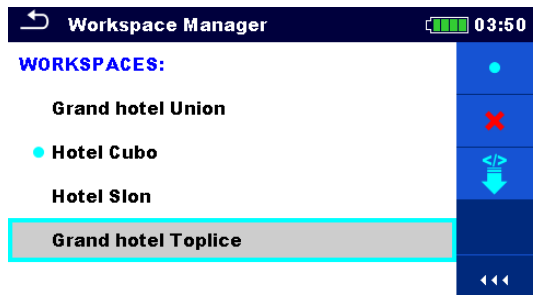

Select a Workspace from Workspace manager list to be exported to an Export file.



Enters option Export.

②

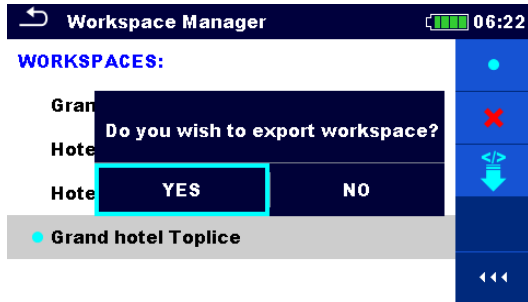

Before exporting the selected Workspace, the user is asked for confirmation.

③

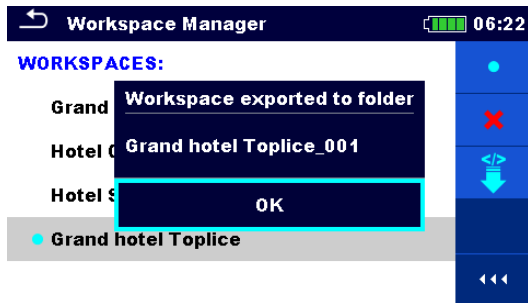

Workspace is exported to Export file and is added to the list of Exports.

Note:

- If an Export file with the same name already exists the name of the Export file will be changed (name_001, name_002, name_003, ...).



8.10 User accounts

The demand to sign in can prevent from unauthorized persons to work with the instrument. In this menu user accounts can be managed:

- Setting if signing in to work with the instrument is required or not.
- Adding and deleting new users, setting their user names and passwords.

The user accounts can be managed by the administrator.

Factory set administrator password: ADMIN

It is recommended to change factory set administrator password after first use. If the custom password is forgotten the second administrator password can be used. This password always unlocks the Account manager and is delivered with the instrument.

If a user account is set and the user is signed in the user's name will be stored in memory for each measurement.

Individual users can change their passwords.

8.10.1 Signing in

If signing in is demanded the user must enter the password in order to work with the instrument.

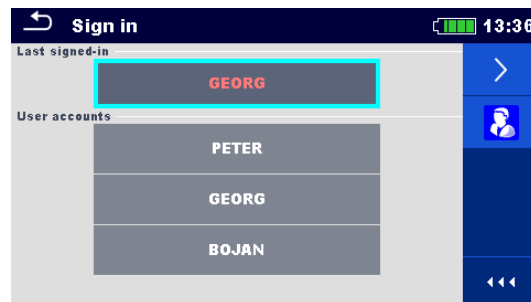

Figure 8.13: Sign in menu

Options

User signing in



The user should be selected first.

The last used user is displayed in the first row.



Sign in with selected user name.

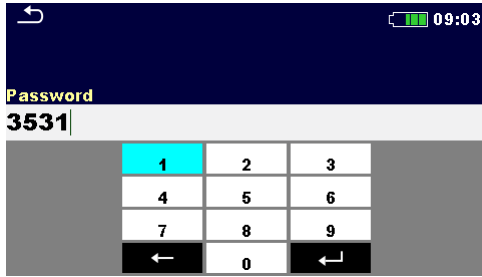

Enter the password and confirm.

The user password consists of an up to 4-digit number.

Administrator signing in



The Account manager menu is accessed by selecting Account manager in Sign in menu or User profile menu.

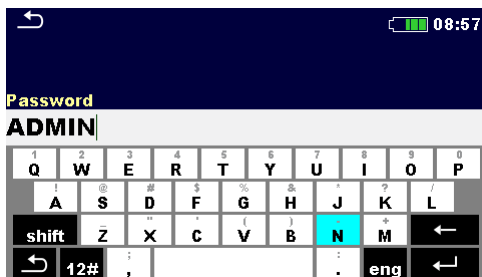

The account manager password must be entered and confirmed first.

Administrator password consists of letters and/or numbers. Letters are case sensitive.

The default password is ADMIN.

8.10.2 Changing user password, signing out



Figure 8.14: User profile menu

Options



Signs out the set user.



Enters procedure for changing the user's password.



The user can change its password. The actual password must be entered first followed by the new password.



Enters the Account manager menu.

8.10.3 Managing accounts

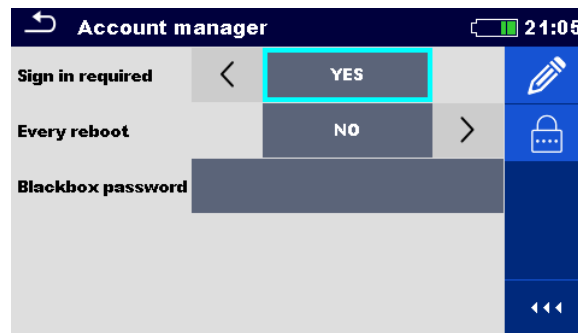
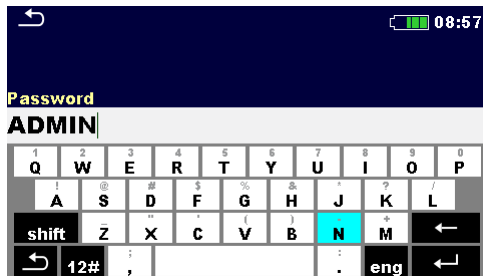

Figure 8.15: Account manager menu

Options



The Account manager menu is accessed by selecting Account manager in Sign in menu or User profile menu.



The account manager password must be entered and confirmed first.

The default password is ADMIN.

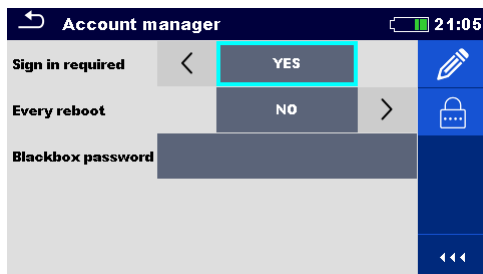

Field for setting if signing in is required to work with the instrument.

Field for setting if signing is required once or at each power on of the instrument.



Enters procedure for changing the account manager (administrator) password.

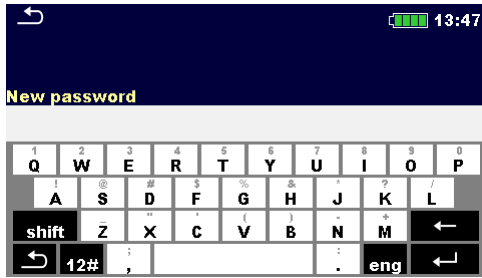

To change the password the actual and then the new password should be entered and confirmed.



Enters menu for editing user accounts.

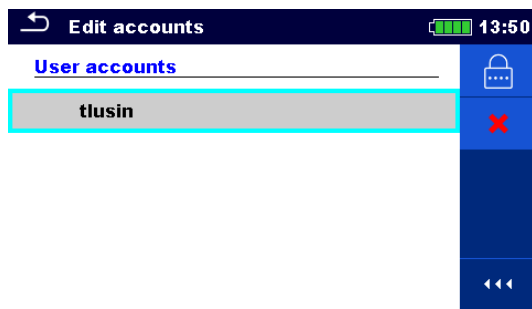
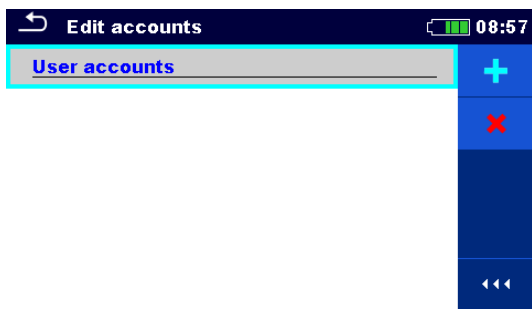
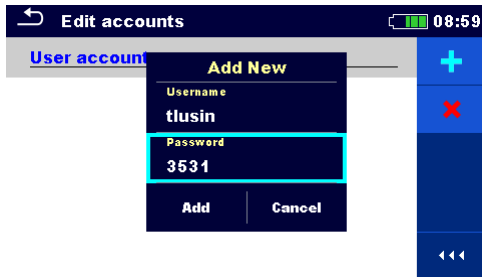

Figure 8.16: Edit accounts menu

Options



Opens the window for adding a new user.



In the Add New window the name and initial password of the new user account are to be set.

'Add' confirms the new user data.



Changes password of the selected user account.

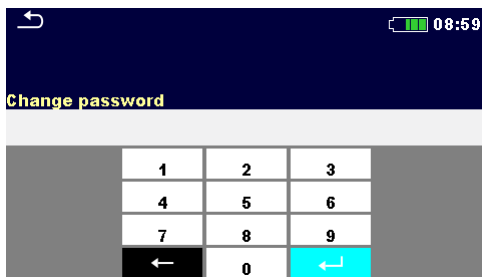

Deletes all user accounts. Deletes the selected user account.

8.10.4 Setting Black-box password

Black-box password can be set by administrator from the Account manager menu. Set Black-box password is valid for all users. Default Black-box password is empty (disabled).

Options

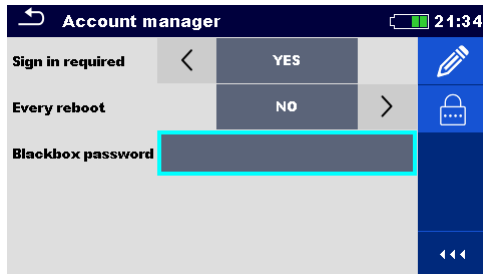

Add or edit Black-box password. Enter to modify.

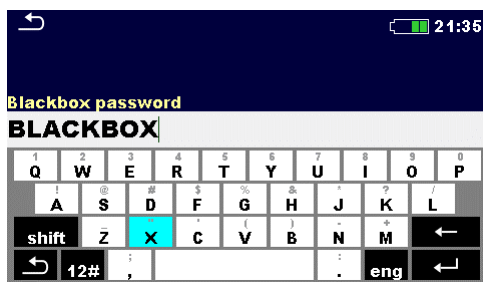

Keyboard for entering new Black-box password is opened. Empty string disables password.

Confirm entry.

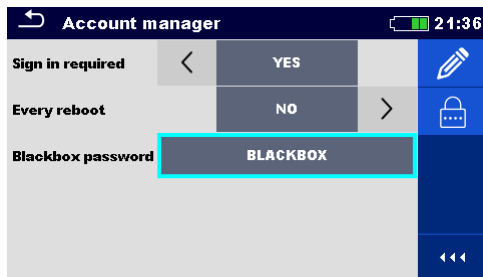

Black-box password is changed.

9 Memory Organizer

Memory Organizer is a tool for storing and working with test data.

9.1 Memory Organizer menu

EI Tester instrument has a multi-level structure. The hierarchy of Memory organizer in the tree is shown on **Figure 9.1**. The data is organized according to the project, object (building, power station, sub-station, transmission tower, ...) and device under test (lightning rod, grounding rod, transformer, mesh, fence, ...). For more information, refer to chapter **Appendix A – Structure objects**.

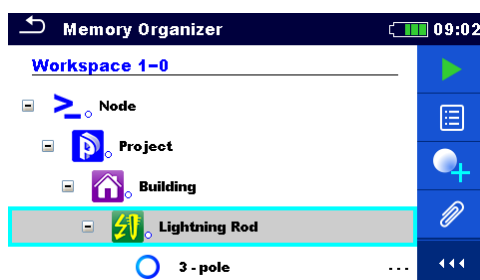

Figure 9.1: Default tree structure and its hierarchy

9.1.1 Measurement statuses





Each measurement has:

- a status (Pass or Fail or no status),
- a name,
- results,
- limits and parameters.

A measurement can be a Single test or an Auto sequence®.

For more information, refer to chapters **11 Tests and Measurements** and **12 Auto Sequences®**.

Statuses of Single tests

-  passed finished single test with test results
-  failed finished single test with test results
-  finished single test with test results and no status
-  empty single test without test results

Overall statuses of Auto Sequences®

-  or  at least one single test in the Auto Sequence® passed and no single test failed
-  or  at least one single test in the Auto Sequence® failed



at least one single test in the Auto Sequence® was carried out and there were no other passed or failed single tests.



empty Auto Sequence® with empty single tests

9.1.2 Structure items

Each Structure item has:

- ❑ an icon
- ❑ a name and
- ❑ parameters.

Optionally they can have:

- ❑ an indication of the status of the measurements under the Structure and a comment or a file attached.



Figure 9.2: Structure project in tree menu

9.1.3 Measurement status indication under the Structure item

Overall status of measurements under each structure item /sub-item can be seen without spreading tree menu. This feature is useful for quick evaluation of test status and as guidance for measurements.

Options



There are no measurement results under selected structure item. Measurements should be made.

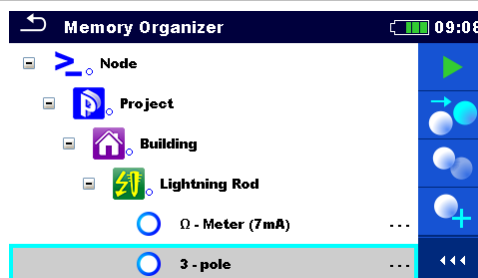

One or more measurement result(s) under selected structure item has failed. Not all measurements under selected structure item have been made yet.

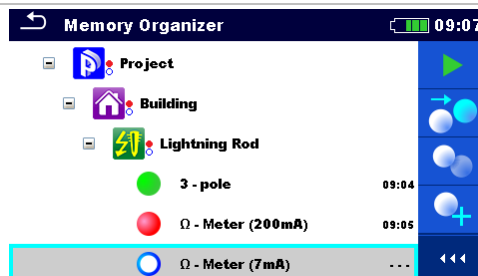

All measurements under selected structure item are completed but one or more measurement result(s) has failed.

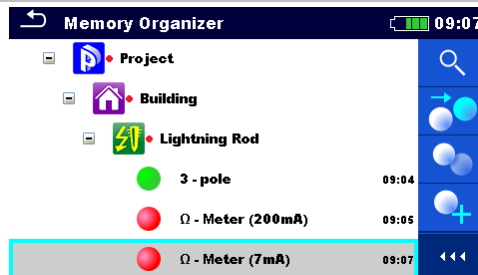

Note:

- There is no status indication if all measurement results under each structure item /sub-item have passed or if there is an empty structure item / sub-item (without measurements).

9.1.4 Operations in Tree menu

In the Memory organizer different actions can be taken with help of the control panel at the right side of the display. Possible actions depend on the selected element in the organizer.

9.1.4.1 Operations on measurements (finished or empty measurements)

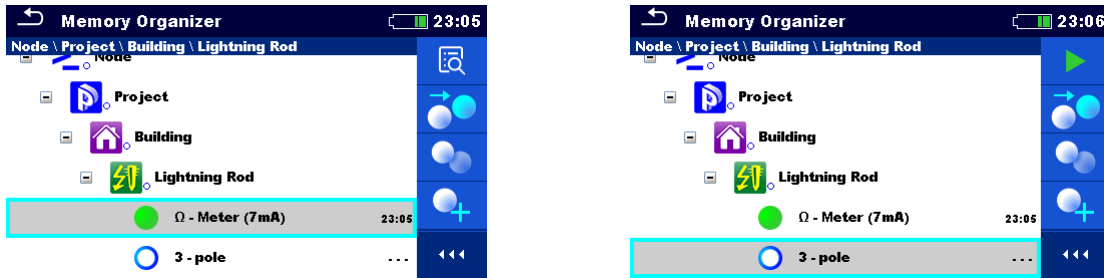

Figure 9.3: A measurement is selected in the Tree menu

Options



Views results of measurement.
The instrument goes to the measurement memory screen.



Starts a new measurement.
The instrument goes to the measurement start screen.



Clones the measurement.
The selected measurement can be copied as an empty measurement under the same Structure item. Refer to chapter **9.1.4.7 Clone a measurement** for more information.



Copy & Paste a measurement.
The selected measurement can be copied and pasted as an empty measurement to any location in structure tree. Multiple “Paste” is allowed. Refer to chapter **9.1.4.11 Copy & Paste a measurement** for more information.



Adds a new measurement.
The instrument goes to the Menu for adding measurements. Refer to chapter **9.1.4.5 Add a new measurement** for more information.



Deletes a measurement.
Selected Measurement can be deleted. User is asked for confirmation before the deleting. Refer to chapter **9.1.4.13 Delete a measurement** for more information.

9.1.4.2 Operations on Structure items

The structure item must be selected first.

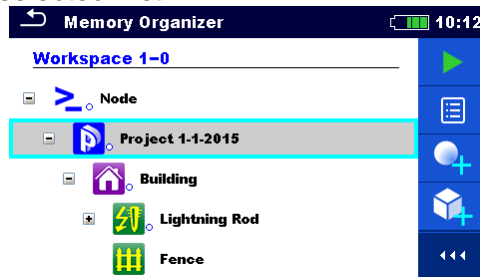

Figure 9.4: A structure project is selected in the Tree menu

Options



Starts a new measurement.

Type of measurement (Single test or Auto Sequence®) should be selected first. After proper type is selected, the instrument goes to Single Test or Auto Sequence® selection screen. Refer to chapter **10.1 Selection modes**.



Saves a measurement.

Saving of measurement under the selected Structure project.



View / edit parameters and attachments.

Parameters and attachments of the Structure items can be viewed or edited. Refer to chapter **9.1.4.3 View / Edit parameters and attachments of a Structure** for more information.



Adds a new measurement.

The instrument goes to the menu for adding measurement into structure. Refer to chapter **9.1.4.5 Add a new measurement** for more information.



Adds a new Structure item.

A new Structure item can be added. Refer to chapter **9.1.4.4 Add a new Structure item** for more information.



Comments.

Comment is displayed.



Attachments.

Name and link of attachment is displayed.



Clones a Structure.

Selected Structure can be copied to same level in structure tree (clone). Refer to chapter **9.1.4.6 Clone a Structure item** for more information.



Renames a Structure item.

Selected Structure item can be renamed via keypad. Refer to chapter **9.1.4.14 Rename a Structure item** for more information.



Copies & Paste a Structure.

Selected Structure can be copied and pasted to any allowed location in structure tree. Multiple "Paste" is allowed. Refer to chapter **9.1.4.8 Copy & Paste a Structure item** for more information.





Cut & Paste a Structure.

Selected Structure with child items (sub-structures and measurements) can be moved to any allowed location in structure tree. Refer to chapter **9.1.4.10 Cut & Paste a Structure item with sub-items** for more information.



Deletes a Structure item.

Selected Structure item and sub-items can be deleted. User is asked for confirmation before the deleting. Refer to chapter **9.1.4.12 Delete a Structure item** for more information.

9.1.4.3 View / Edit parameters and attachments of a Structure

The parameters and their content are displayed in this menu. To edit the selected parameter, tap on it or press tab key followed by enter key to enter menu for editing parameters.

Procedure

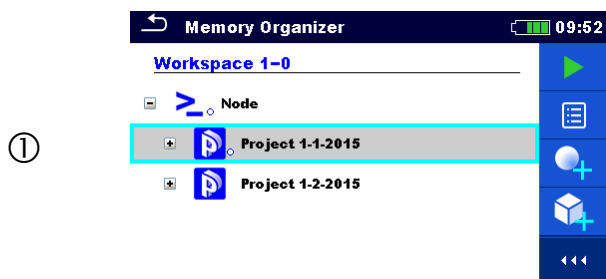

①

Select structure item to be edited.

②



Select Parameters in Control panel.

③

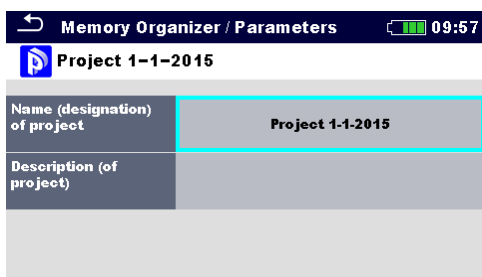

Example of Parameters menu.

In menu for editing parameters the parameter's value can be selected from a dropdown list or entered via keypad. Refer to chapter **6 Instrument operation** for more information about keypad operation.

②a



Select Attachments in Control panel.

③a

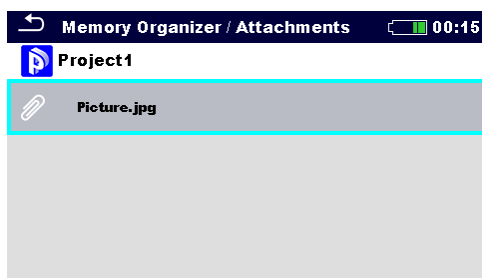

Attachments

The name of attachment can be seen. Operation with attachments is not supported in the instrument.

②b



Select Comments in Control panel.

③b



Comments
Complete comment (not shorted) attached to the structure object can be seen on this screen.

9.1.4.4 Add a new Structure item

This menu is intended to add new structure item in the tree menu. A new structure item can be selected and then added in the tree menu.

Procedure

①

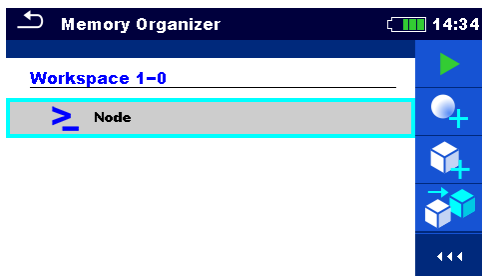

Default initial structure.

②



Select Add Structure in Control panel.

③



Add a new structure project menu.

④a



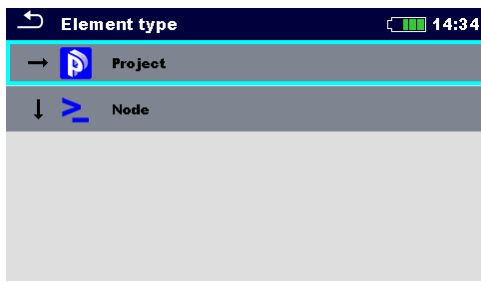

Tap on a structure type selection window.

④ b



A list of available structure items is displayed. Select one from a list. Arrow indicates the position where structure item will be inserted.

-  Child item to the currently selected structure item.
-  Structure item located in the same level.

④ c

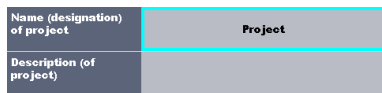

In menu for editing name and parameters the parameter's value can be selected from a dropdown list or entered via keypad. Refer to chapter 6 **Instrument operation** for more information about keypad operation.

⑤



Create new structure item.

⑥

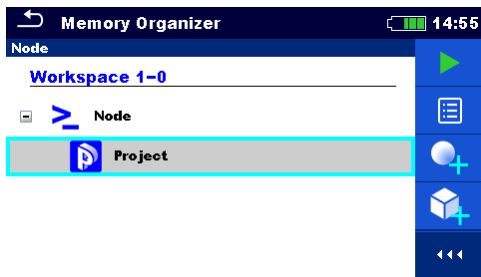

New project added.

9.1.4.5 Add a new measurement

In this menu new empty measurements can be set and then added in the structure tree. The type of measurement, measurement function and its parameters are first selected and then added under the selected Structure item.

Procedure

①		<p>Select level in structure where measurement will be added.</p>
②		<p>Select Add measurement in Control panel.</p>
③		<p>Add new measurement menu.</p>
④ a		<p>Type of test can be selected from this field. Options: Single Tests, Auto Sequence®. Tap on field or press the enter key to modify.</p>
④ b		<p>Last added measurement is offered by default. To select another measurement, tap on field or press enter to open menu for selecting measurements.</p>
④ c		<p>Select parameter and modify it as described earlier. Refer to chapter 10.1.2 Setting parameters and limits of single tests for more information.</p>
⑤		<p>Adds the measurement under the selected Structure project in the tree menu.</p> <p>Returns to the structure tree menu without changes.</p>

⑥

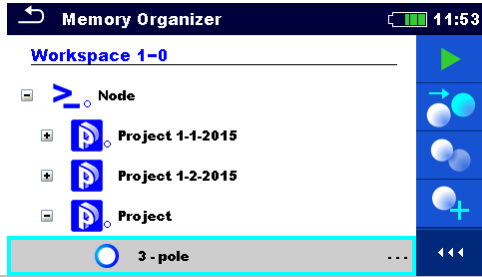

New empty measurement is added under the selected Structure project.

9.1.4.6 Clone a Structure item

In this menu selected structure item can be copied (cloned) to same level in the structure tree. Cloned structure items have same name as original.

Procedure

①

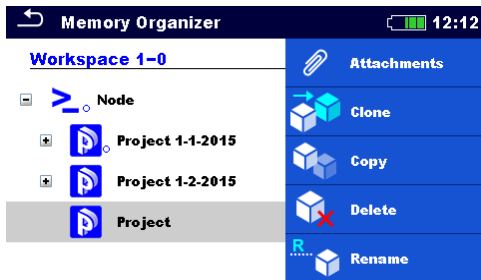

Select the structure item to be cloned.

②



Select Clone in Control panel.

③

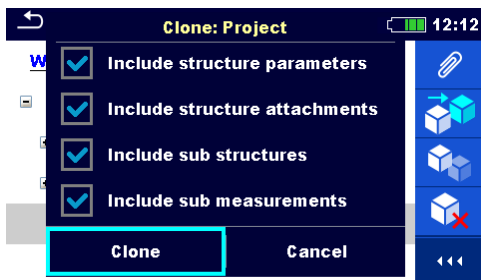

The Clone Structure menu is displayed. Sub-elements of the selected structure item can be marked or un-marked for cloning. Refer to chapter **9.1.4.9 Cloning and Pasting sub-elements of selected structure item** for more information.

④

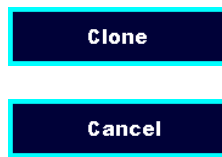

Selected structure item is copied (cloned) to same level in the structure tree.

Cloning is cancelled. No changes in the Structure tree.

⑤

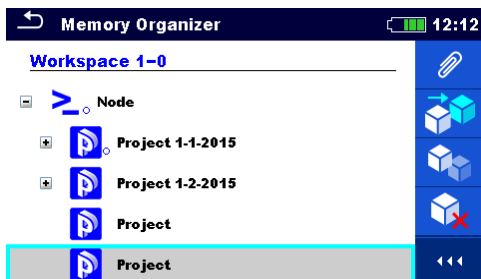

The new structure item is displayed.

9.1.4.7 Clone a measurement

By using this function, a selected empty or finished measurement can be copied (cloned) as an empty measurement to the same level in the structure tree.

Procedure

①  Select the measurement to be cloned.

②  Select Clone in Control panel.

③  A new empty measurement is displayed.

9.1.4.8 Copy & Paste a Structure item

In this menu selected Structure item can be copied and pasted to any allowed location in the structure tree.

Procedure

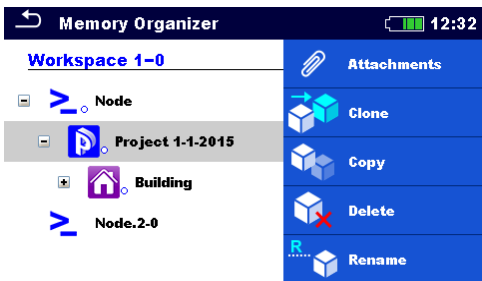
①  Select the structure item to be copied.

②  Select Copy in control panel.

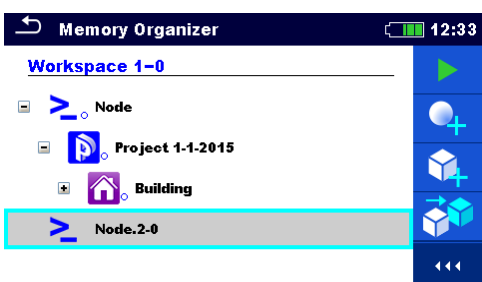
③  Select location where structure item should be copied.

④  Select Paste in Control panel.

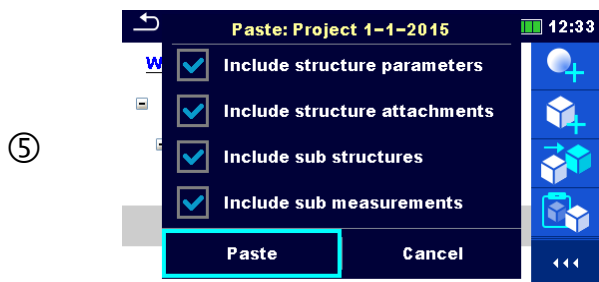

The Paste structure menu is displayed. Before copying it can be set which sub-elements of the selected structure item will be copied too. Refer to chapter **9.1.4.9 Cloning and Pasting sub-elements of selected structure item** for more information.



The selected structure item and elements are copied (pasted) to selected position in the tree structure.

Returns to the tree menu without changes.

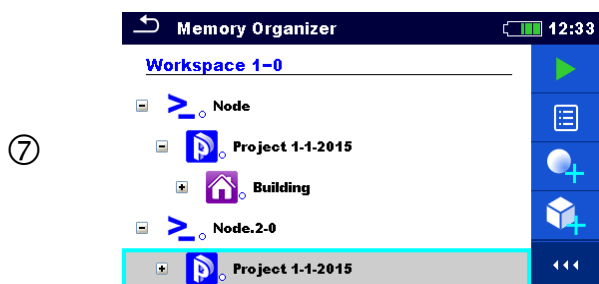

The new structure item is displayed.

Note:

- The Paste command can be executed one or more times.

9.1.4.9 Cloning and Pasting sub-elements of selected structure item

When structure item is selected to be cloned, or copied & pasted, additional selection of its sub-elements is needed. The following options are available:

Options

- | | |
|--|--|
| <input checked="" type="checkbox"/> Include structure parameters | Parameters of selected structure item will be cloned / pasted too. |
| <input checked="" type="checkbox"/> Include structure attachments | Attachments of selected structure item will be cloned / pasted too. |
| <input checked="" type="checkbox"/> Include sub structures | Structure items in sub-levels of selected structure item (sub-structures) will be cloned / pasted too. |
| <input checked="" type="checkbox"/> Include sub measurements | Measurements in selected structure item and sub-levels (sub-structures) will be cloned / pasted too. |

9.1.4.10 Cut & Paste a Structure item with sub-items

In this menu selected Structure item with sub-items (sub-structures and measurements) can be cut and pasted (moved) to any allowed location in the structure tree.

Procedure

①  Select the structure item to be moved.

②  Select Cut in Control panel.

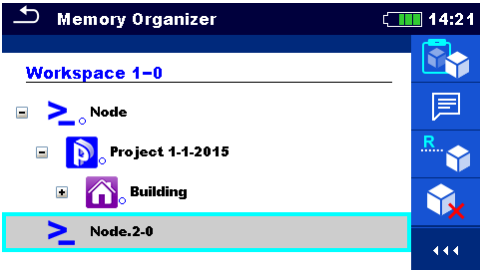
③  Select new location where structure item (with sub-structures and measurements) should be moved.

④  Select Paste in Control panel.

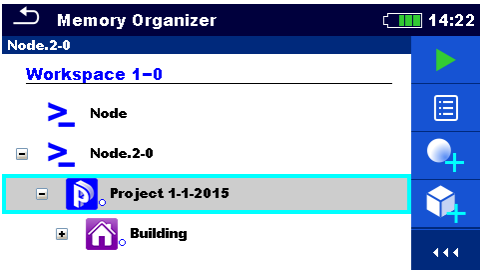
⑤  The structure item (with sub-structures and measurements) is moved to selected new location and deleted from previous location in the tree structure.

9.1.4.11 Copy & Paste a measurement

In this menu selected measurement can be copied to any allowed location in the structure tree.

Procedure

①  Select the measurement to be copied.

②



Select Copy in Control panel.

③

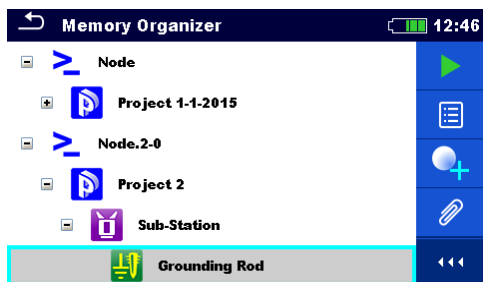

Select the location where measurement should be pasted.

④



Select Paste in Control panel.

⑤

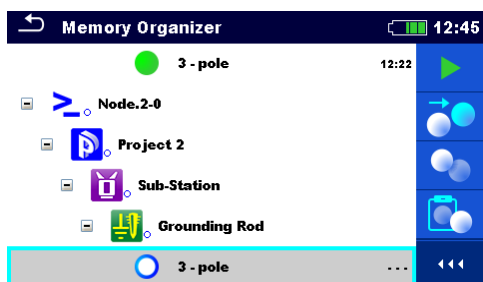

A new (empty) measurement is displayed in selected Structure item.

Note:

- ❑ The Paste command can be executed one or more times.

9.1.4.12 Delete a Structure item

In this menu selected Structure item can be deleted.

Procedure

①

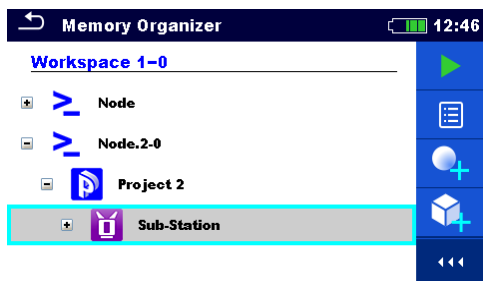

Select the structure item to be deleted.

②



Select Delete in Control panel.

③

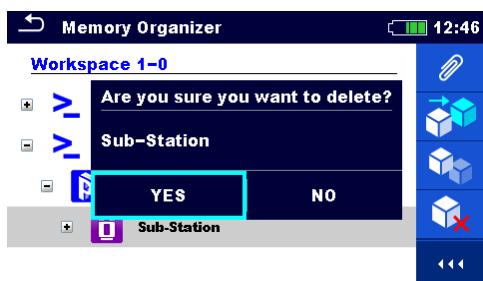

A confirmation window will appear.

④

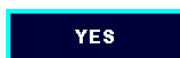

Selected structure item and its sub-elements are removed.

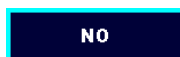

Returns to the tree menu without changes.

⑤

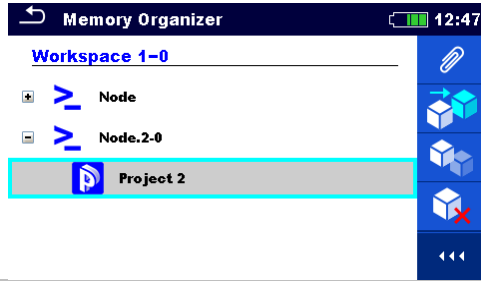

Structure without deleted structure item.

9.1.4.13 Delete a measurement

In this menu selected measurement can be deleted.

Procedure

①

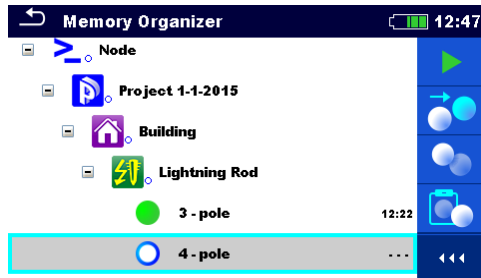

Select a measurement to be deleted.

②



Select Delete in Control panel.

③

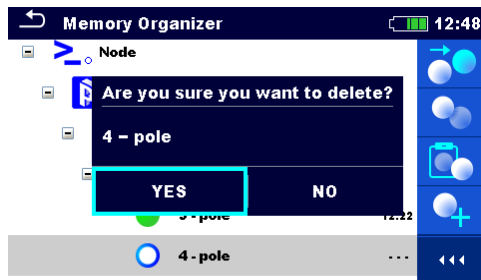

A confirmation window will appear.

④

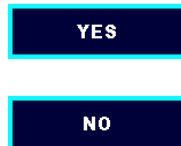

Selected measurement is deleted.

Returns to the tree menu without changes.

⑤

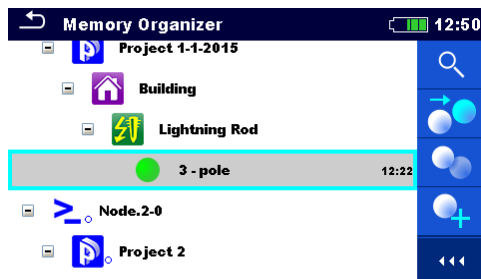

Structure without deleted measurement.

9.1.4.14 Rename a Structure item

In this menu selected Structure item can be renamed.

Procedure

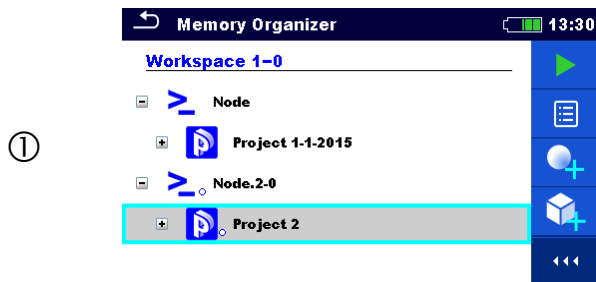

Select the structure item to be renamed.



Select Rename in Control panel. Virtual keypad will appear on screen. Enter new text and confirm. Refer to chapter **6.3 Virtual keyboard** for keypad operation.

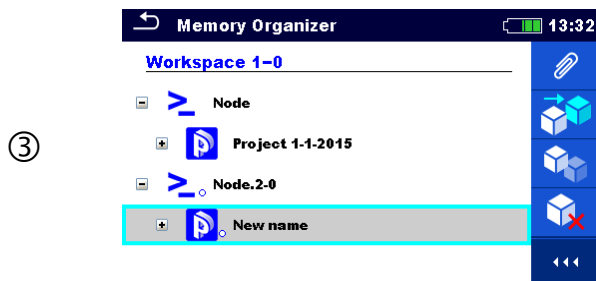

Structure item with the modified name.

9.1.4.15 Recall and Retest selected measurement

Procedure

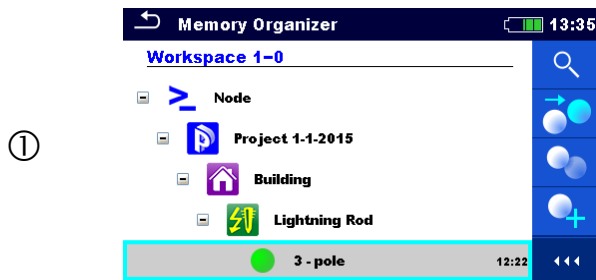

Select the measurement to be recalled.



Select Recall results in Control panel.

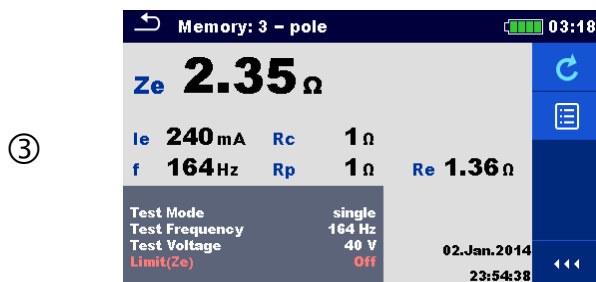

Measurement is recalled.

Parameters and limits can be viewed but cannot be edited.



Select Retest in Control panel.

⑤

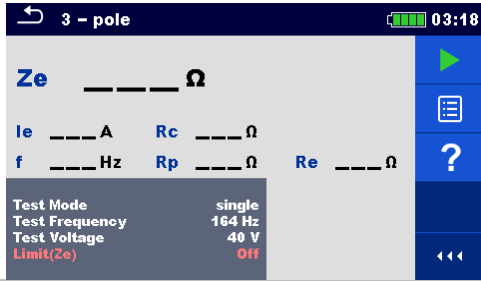

Measurement retest starting screen is displayed.

⑤ a



Parameters and limits can be viewed and edited.

⑥



Select Run in Control panel to retest the measurement.

⑦

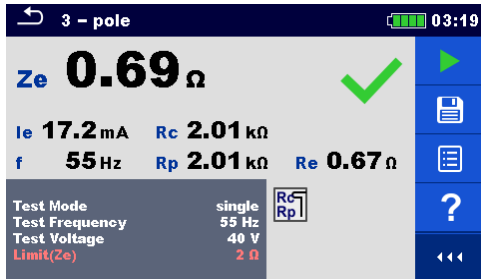

Results / sub-results after re-run of recalled measurement.



Select Save results in Control panel.

⑧

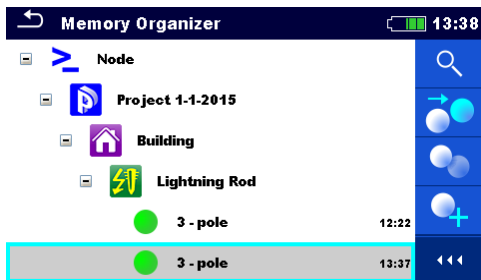

Retested measurement is saved under same structure item as original one. Refreshed memory structure with the new performed measurement is displayed.

10 Single tests

Single measurements and tests can be selected in the main Single tests menu or in Memory organizer's main and sub-menus.

10.1 Selection modes

In Single tests main menu three modes for selecting single tests are available.

Options



Groups

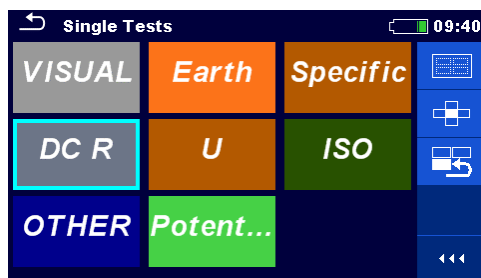

The single tests are divided into groups of similar tests.



Cross selector

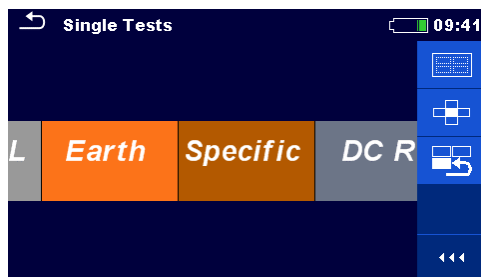

This selection mode is the fastest for working with the keypad. Groups of single tests are organized in a row.

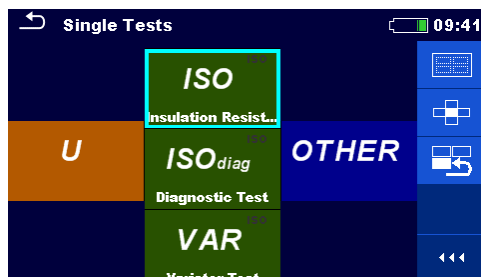

For the selected group all single tests are displayed and easily accessible with up /down keys.



Last used

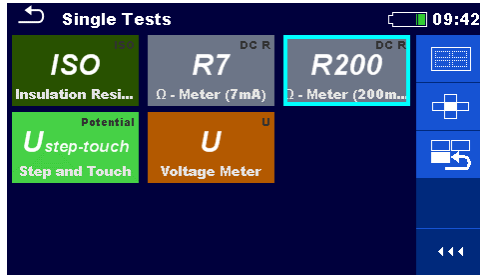

Last 9 made different single tests are displayed.

10.1.1 Single test screens

In the Single test screens measuring results, sub-results, limits and parameters of the measurement are displayed. In addition, on-line statuses, warnings and other info are displayed.

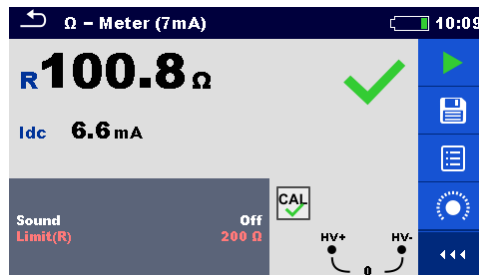

Figure 10.1: Single test screen organization Example of Ω-Meter (7mA) measurement

Single test screen organization:



Main line:

- ESC touch key
- function name
- battery status
- time



Control panel (available options)



Parameters (white) and limits (red)



Result field:

- main result(s)
- sub-result(s)
- PASS / FAIL indication

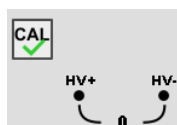

Warning symbols, message field and terminal voltage monitor

10.1.2 Setting parameters and limits of single tests

Procedure

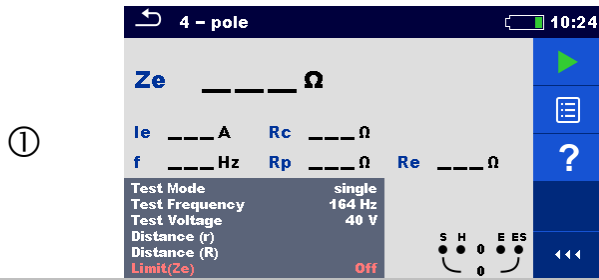

Select the test or measurement.
The test can be entered from:

- Single tests menu or
- Memory organizer menu once the empty measurement was created under selected structure.



Select Parameters in Control panel.

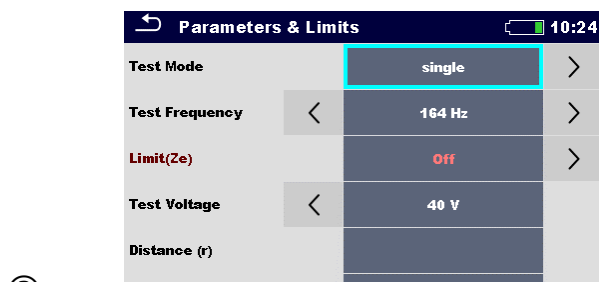

Select parameter to be edited or limit to be set.

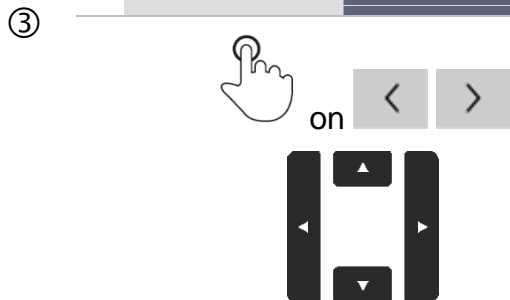

Set parameter / limit value.

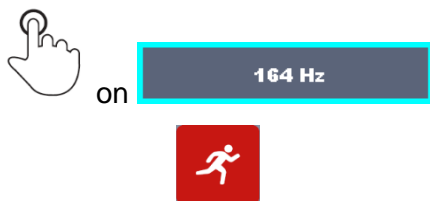

Enter Set value menu.

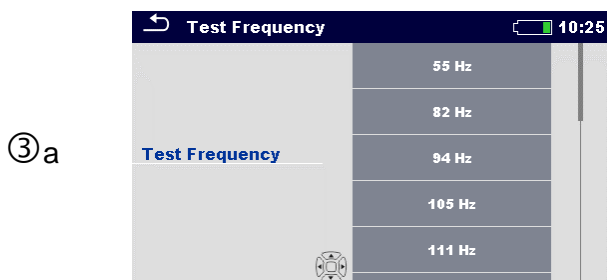

Set value menu.

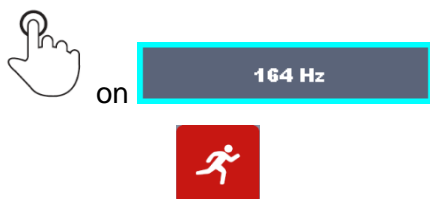

Accepts a new parameter or limit value and exits Set value menu.

④



Accepts the new parameters and limit values.

10.1.3 Single test result screen

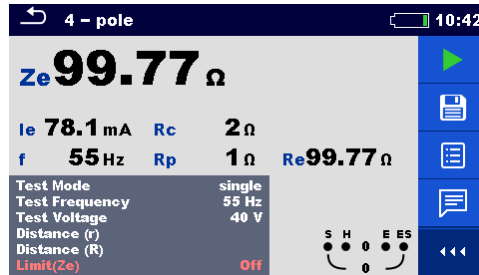

Figure 10.2: Single test result screen Example of 4 -pole measurement

Options (after measurement is finished)



Starts a new measurement.

Saves the result.

A new measurement was selected and started from a Structure object in the structure tree:

- ❑ the measurement will be saved under the selected Structure object.

A new measurement was started from the Single test main menu:

- ❑ saving under the last selected Structure object will be offered by default. The user can select another Structure object or create a new Structure object.



- ❑ By pressing the  key in Memory organizer menu the measurement is saved under selected location.

An empty measurement was selected in structure tree and started:

- ❑ the result(s) will be added to the measurement. The measurement will change its status from 'empty' to 'finished'.

An already carried out measurement was selected in structure tree, viewed and then restarted:

- ❑ a new measurement will be saved under the selected Structure object.



Opens help screens.



on

Opens menu for changing parameters and limits of selected measurements. Refer to chapter **10.1.2 Setting parameters and limits of single tests** for more information how to change measurement parameters and limits.

Test Mode	single
Test Frequency	55 Hz
Test Voltage	40 V
Distance (r)	
Distance (R)	
Limit(Ze)	Off



long on

Ze 99.77 Ω			
Ie	78.1 mA	Rc	2 Ω
f	55 Hz	Rp	1 Ω
		Re	99.77 Ω

Enters cross selector to select test or measurement.

10.1.4 Recall single test result screen

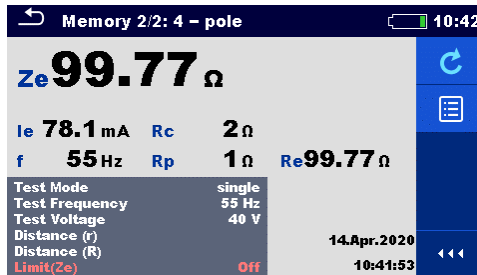

Figure 10.3: Recalled results of selected measurement, example of 4 -pole measurement recalled results

Options



Retest

Enters starting screen for a new measurement.



on

Test Mode	single
Test Frequency	55 Hz
Test Voltage	40 V
Distance (r)	
Distance (R)	
Limit(Ze)	Off

Opens menu for changing parameters and limits of selected measurements. Refer to chapter **10.1.2 Setting parameters and limits of single tests** for more information how to change measurement parameters and limits.

10.1.5 Single test (Visual Test) screens

Visual Test can be treated as a special class of tests. Items to be visually checked are displayed. In addition, on-line statuses and other information are displayed.

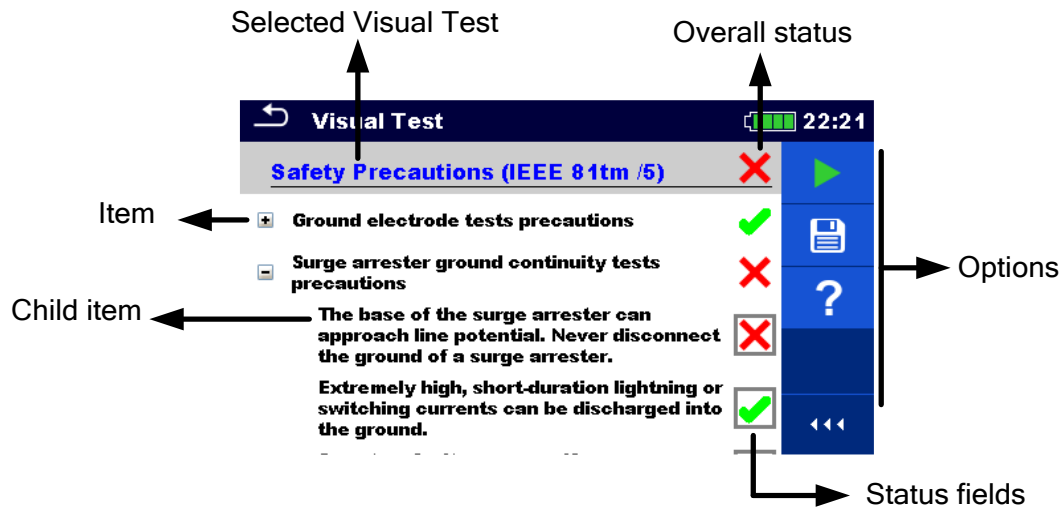

Figure 10.4: Visual Test screen organisation

10.1.6 Single test (Visual Test) start screen

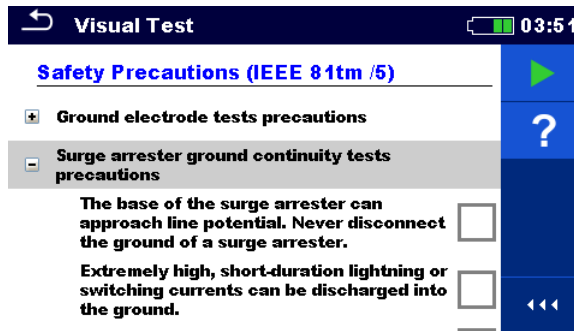

Figure 10.5: Visual Test screen organisation

Options (before Visual Test screen was opened in Memory organizer or from Single test main menu)



Starts the Visual Test



Opens help screens.

10.1.7 Single test (Visual Test) screen during test

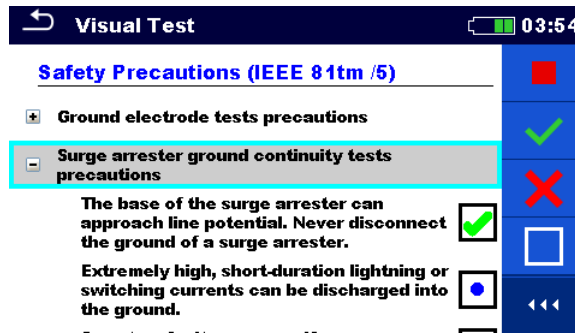
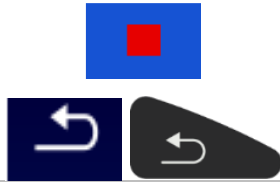

Figure 10.6: Visual Test screen during test

Options (during test)

	Selects item
	Applies a pass to the selected item or group of items.
	Applies a fail to the selected item or group of items.
	Clears status in selected item or group of items.
	Applies a status that item or group of items was checked.
	A status can be applied.
	Toggle between statuses.



Goes to the result screen.

10.1.8 Single test (Visual Test) result screen

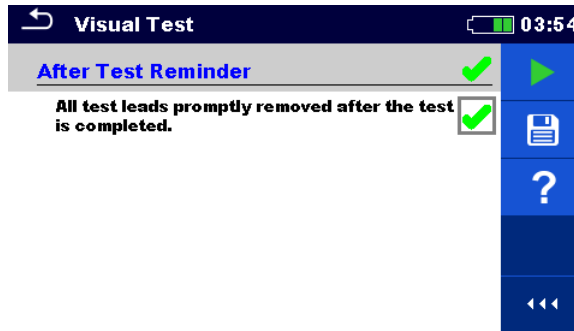

Figure 10.7: Visual Test result screen

Options (after Visual Test is finished)



Starts a new Visual Test.

Saves the result.

A new Visual Test was selected and started from a Structure object in the structure tree:

- The Visual Test will be saved under the selected Structure object.

A new Visual Test was started from the Single test main menu:



- Saving under the last selected Structure object will be offered by default. The user can select another Structure object or create a new Structure object. By pressing the  key in Memory organizer menu the Visual Test is saved under selected location.

An empty Visual Test was selected in structure tree and started:

- The result(s) will be added to the Visual Test. The Visual Test will change its status from 'empty' to 'finished'.

An already carried out Visual Test was selected in structure tree, viewed and then restarted:

A new measurement will be saved under the selected Structure object.

10.1.9 Single test (Visual Test) memory screen

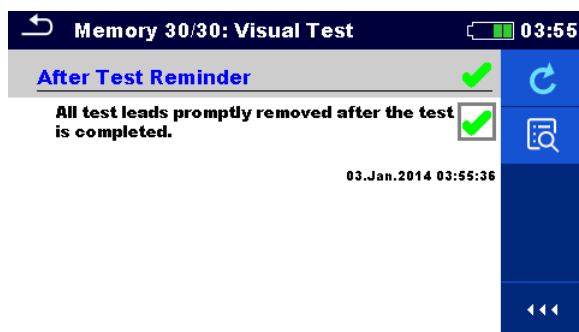

Figure 10.8: Visual Test memory screen

Options



Retest



Enters starting screen and starts the new Visual test.



Set cursor for viewing data on multiple pages.

11 Tests and Measurements

11.1 Visual tests

Visual tests are used as guidance to maintain safety standards prior testing. To use those visual tests please select VISUAL under Single tests. Visual tests are prepared to make all safety checks before starting the test.

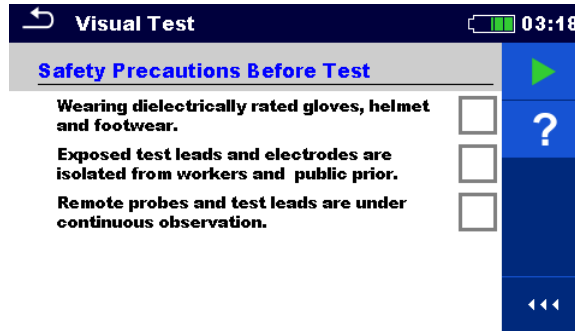





Figure 11.1: Visual Test menu

Options

	Pass
	Fail
	Clear
	Checked

Safety Precautions Before Test

No.	Description	Values
1	Wearing dielectrically rated gloves, helmet and footwear.	Pass/Fail/Clear/Checked
2	Exposed test leads and electrodes are isolated from workers and public prior.	Pass/Fail/Clear/Checked
3	Remote probes and test leads are under continuous observation.	Pass/Fail/Clear/Checked

Table 11.1: Visual Test - Safety Precautions Before Test

Safety Hazards During Test

No.	Description	Values
1	Avoid ungrounded ends of test leads.	Pass/Fail/Clear/Checked
2	Surge arrester can approach line potential.	Pass/Fail/Clear/Checked
3	Never disconnect the ground.	Pass/Fail/Clear/Checked
4	Lightning or switching currents can be discharged into the ground.	Pass/Fail/Clear/Checked
5	A system fault can occur if a surge arrester fails during testing.	Pass/Fail/Clear/Checked
6	Hazard can occur when disconnecting neutral and shield wires.	Pass/Fail/Clear/Checked
7	Hazard can occur due to current flow through the interconnected shield wires.	Pass/Fail/Clear/Checked
8	High voltages can occur if neutrals are disconnected from energized equipment.	Pass/Fail/Clear/Checked

Table 11.2: Visual Test – Hazards During Test

After Test Reminder

No.	Description	Values
1	All test leads promptly removed after the test is completed.	Pass/Fail/Clear/Checked

Table 11.3: Visual Test – After Test Reminder

Safety Precautions (IEEE 81tm /5)

No.	Description	Values
1	Ground electrode tests precautions. <ul style="list-style-type: none"> Reduced the hazards associated with handling test leads by wearing gloves and dielectrically rated footwear. Exposed test leads and electrodes are isolated from workers and the general public prior. Short test periods assured and all test leads promptly removed after the test is completed. Remote probes and test leads are under continuous observation. Ungrounded ends of test leads parallel an energized line mitigated by the physical orientation of test leads, grounding, or both. 	Pass/Fail/Clear/Checked
2	Surge arrester ground continuity tests precautions. <ul style="list-style-type: none"> The base of the surge arrester can approach line potential. Never disconnect the ground of a surge arrester. Extremely high, short-duration lightning or switching currents can be discharged into the ground. A system fault can occur if a surge arrester fails during testing. 	Pass/Fail/Clear/Checked
3	Neutral and shield wire ground tests procedures. <ul style="list-style-type: none"> Disconnecting neutral and shield wires can generate hazardous voltages. Hazard can occur whether the line is energized or not, due to current flow through the interconnected shield wires. 	Pass/Fail/Clear/Checked
4	Equipment neutral ground test precautions. <ul style="list-style-type: none"> High voltages can occur if neutrals are disconnected from energized equipment. 	Pass/Fail/Clear/Checked

Table 11.4: Visual Test – Safety Precautions (IEEE 81tm /5)

Visual Test procedure:

- Select Visual function.
- Start the Visual Test.
- Perform the Visual Test.
- Apply appropriate ticker(s) to items.
- End Visual Test.
- Save results (optional).

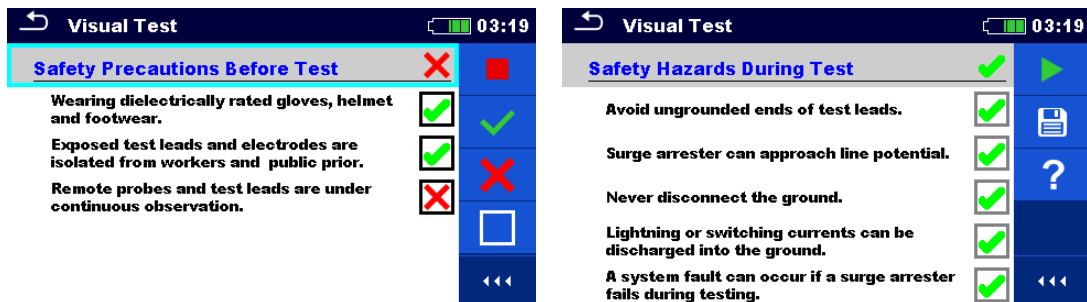

Figure 11.2: Examples of Visual Test results

11.2 Voltage and Frequency Measurements [U/f]

Voltage measurement is common function, for example, when locating installation faults or, as a safety measure, before starting any installation adaptation activity.

11.2.1 Voltage Meter

It is a simple function that continuously measures the DC and AC voltage and frequency across HV+ and HV- terminals.

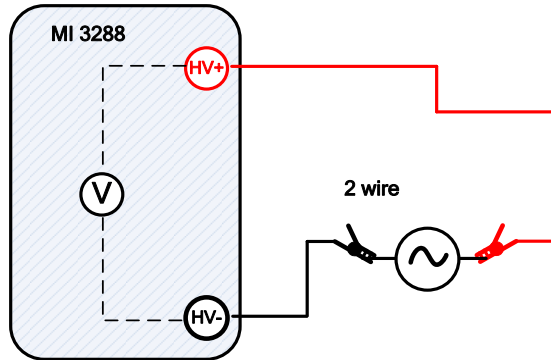

Figure 11.3: Voltage Meter measurement example

Test can be started from the Voltage Meter measurement window. Before carrying out a test the following parameter (Result Type) can be edited.

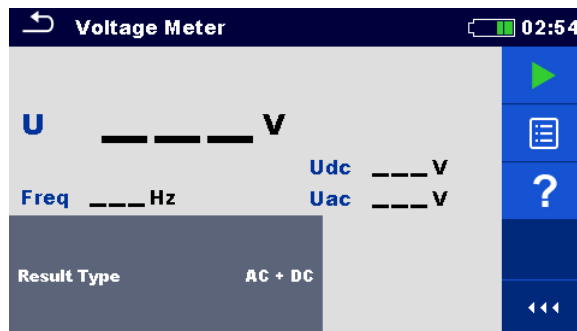

Figure 11.4: Voltage Meter measurement menu

Test parameters for Voltage Meter:

Result Type Set type of main result voltage: [AC, DC, AC+DC]

Voltage Meter measurement procedure:

- Select the Voltage Meter measurement function.
- Set the test parameter (result type).
- Connect the test leads to the instrument and to the test object.
- Press the Run key to start the measurement.
- Wait until the test result is displayed on the screen.
- Press the Run key again to stop the measurement.
- Save results (optional).

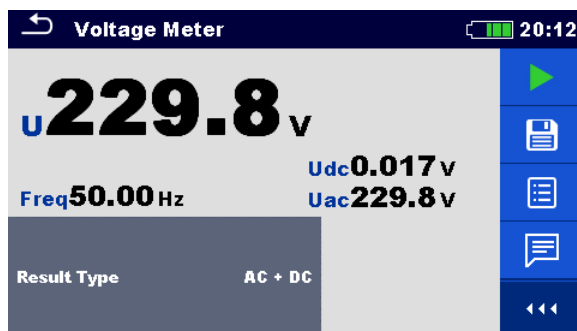

Figure 11.5: Example of Voltage Meter measurement result



Warning!

- Do not connect test terminals to external voltage higher than 1000 V a.c. or d.c., in order not to damage the test instrument!

Note:

- Consider displayed warnings when starting the measurement!

11.3 Earth Measurements [Ze and Re]

Result of Earth measurement is one of the most important parameters for protection against electric shock. Main installation earthing arrangements, lightning systems, local earthings, soil resistivity, etc. can be verified with the EI Tester.

The MI 3288 is able to carry out Earth measurements using different methods. The appropriate one should be selected by the operator, depending on the particular earthing system to be tested.

Earth		Measurement	Test Mode	LF	HF	Filter	Test Voltage
Impedance	Resistance						
Ze	Re	2 – pole	single	55 Hz	164 Hz	FFT	20/40 V
		3 – pole	single				20/40 V
		4 – pole	single				20/40 V
Zsel	/	Selective (Iron Clamp)	single				40 V
Ze	/	2 Clamps	cont.	82 Hz			40 V

Table 11.5: Available Earth measurements in the MI 3288

11.3.1 2 – pole measurement

The two-pole measurement can be used if there is a well-grounded auxiliary terminal available (e.g. source/ distribution earthings via the neutral conductor, water pipeline...). The main advantage of this method is that no test probes are needed for the test. The method is fast and relatively reliable.

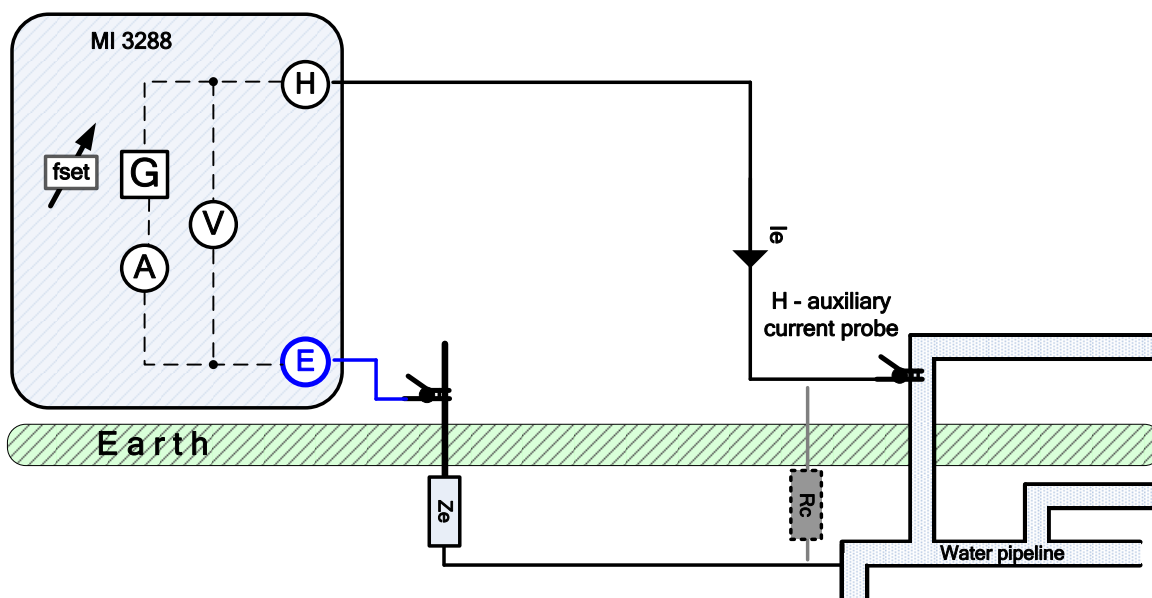

Figure 11.6: 2 – pole measurement example

During the measurement, a sinusoidal current I_e is injected into the earth through an auxiliary probe (H). The impedance of the auxiliary probe (H) should be as low as possible. The impedance R_c can be decreased by using more probes in parallel or using an auxiliary earthing system as the auxiliary probe. A higher injected current improves the immunity against spurious earth currents. The earth impedance Z_e is determined from the voltage/current ratio. Usually, the impedance R_c is much lower than Z_e . In this case the result can be considered as $\approx Z_e$.

$$Z_e = \frac{U_{H-E}[V]}{I_e[A]} = [\Omega] \quad \text{where} \quad Z_e \gg R_c$$

- Z_e Earth impedance
- R_e Earth resistance (excluding reactance)
- R_c Impedance of auxiliary current probe (H)
- I_e Injected test current
- U_{H-E} Test voltage between H and E terminal
- f_{set} Test frequency

Refer to **Appendix C – Functionality and placing of test probes** for more information how to place the auxiliary current probe (H).

Test can be started from the 2 - pole measurement window. Before carrying out a test the following parameters (Test Mode, Test Voltage, Test Frequency, Distance and Limit (Z_e)) can be edited.

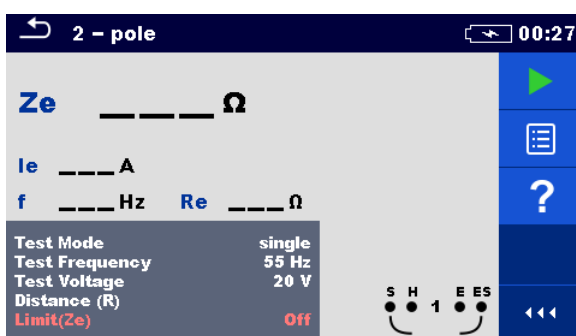

Figure 11.7: 2 - pole measurement menu

Test parameters for 2 – pole:

Test Mode	Test mode: [single]
Test Frequency	Set test frequency: [55 Hz, 82 Hz, 94 Hz, 105 Hz, 111 Hz, 128 Hz, 164 Hz]
Test Voltage	Set test voltage: [20 V or 40 V]
Distance (R)	Distance between E and auxiliary earth rod H (user defined).
Limit (Z_e)	Limit value selection: [OFF, Custom, 0.1 Ω – 5.00 kΩ]

2-pole measurement procedure:

- Select the 2-pole measurement function.
- Set the test parameters (voltage, frequency, distance and limit).
- Connect the test leads to the instrument and to the test object.
- Press the Run key to start the measurement.
- Wait until the test result is displayed on the screen.
- Save results (optional).

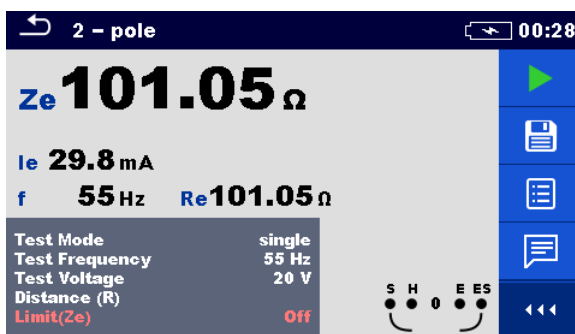

Figure 11.8: Example of 2-pole measurement result

Notes:

- ❑ Consider displayed warnings when starting the measurement!
- ❑ High noise currents and voltages in earth could influence the measurement results. The tester displays the “noise” warning in this case.

Notes related to probes:

- ❑ High impedance of H probe could influence the measurement results.
- ❑ Probes must be placed at a sufficient distance from the measured object.

11.3.2 3 – pole measurement

The three-pole measurement is the standard earthing test method. It is the only choice if there is no well earthed auxiliary terminal available. The measurement is performed with two earthing probes. The drawback if using three wires is that the contact resistance of E terminal is added to the result.

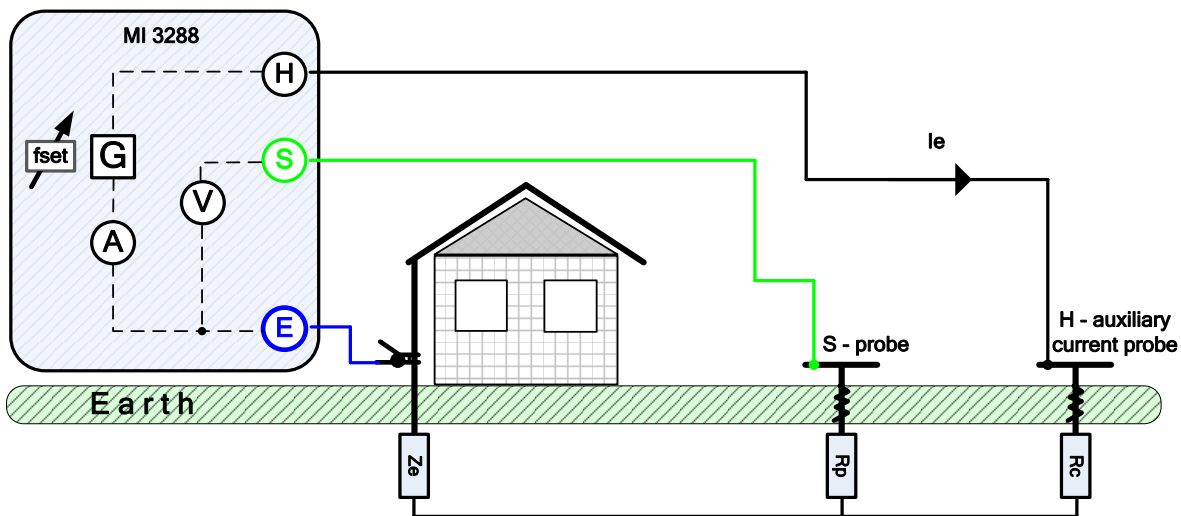

Figure 11.9: 3 – pole measurement example

During the measurement a sinusoidal current I_e is injected into the earth through an auxiliary current probe (H). The impedance of the auxiliary probe (H) should be as low as possible in order to inject a high test current. The impedance R_c can be decreased by using more probes in parallel. A higher injected current improves the immunity against spurious earth currents. The voltage drop is measured by auxiliary potential probe (S). The earth impedance Z_e is determined from the voltage/current ratio.

In the example following earth impedance is measured at a set frequency:

$$Z_e = \frac{U_{S-E} [V]}{I_e [A]} = [\Omega]$$

where:

- Z_e Earth impedance
- R_e Earth resistance (excluding reactance)
- R_c Impedance of auxiliary current probe (H)
- R_p Impedance of auxiliary potential probe (S)
- I_e Injected test current
- U_{S-E} Test voltage between S and E terminal
- f_{set} Test frequency

Refer to **Appendix C – Functionality and placing of test probes** for more information how to place the earth auxiliary current (H) and potential probe (S).

Test can be started from the 3 - pole measurement window. Before carrying out a test the following parameters (Test Mode, Test Voltage, Test Frequency, Distance and Limit (Ze)) can be edited.

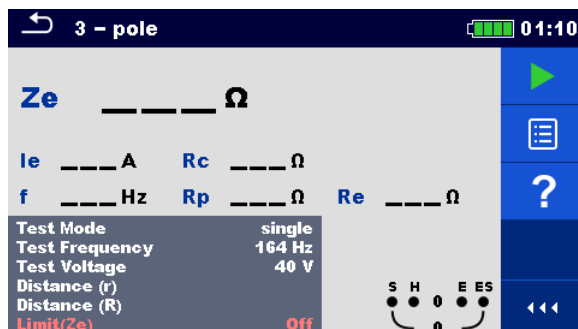

Figure 11.10: 3 - pole measurement menu

Test parameters for 3 – pole:

Test Mode	Test mode: [single]
Test Frequency	Set test frequency: [55 Hz, 82 Hz, 94 Hz, 105 Hz, 111 Hz, 128 Hz, 164 Hz]
Test Voltage	Set test voltage: [20 V or 40 V]
Distance (r)	Distance between E and S probe (user defined).
Distance (R)	Distance between E and auxiliary earth rod H (user defined).
Limit (Ze)	Limit value selection: [OFF, Custom, 0.1 Ω – 5.00 kΩ]

3-pole measurement procedure:

- Select the 3-pole measurement function.
- Set the test parameters (voltage, frequency, distance and limit).
- Connect the test leads to the instrument and to the test object.
- Press the Run key to start the measurement.
- Wait until the test result is displayed on the screen.
- Save results (optional).

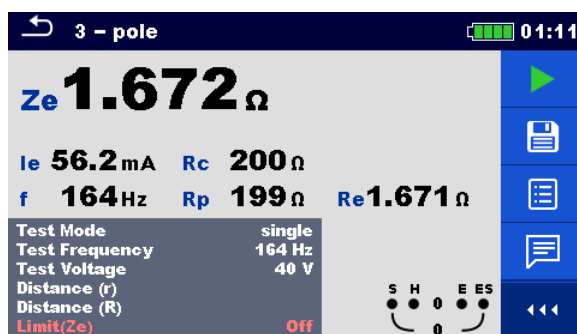

Figure 11.11: Example of 3-pole measurement result

Notes:

- Consider displayed warnings when starting the measurement!
- High noise currents and voltages in earth could influence the measurement results. The tester displays the “noise” warning in this case.

Notes (Probes):

- High impedance of S and H probes could influence the measurement results. In this case, “Rp” and “Rc” warnings are displayed.
- Probes must be placed at a sufficient distance from the measured object.

11.3.3 4 – pole measurement

The advantage for using of four-pole test is that the leads and contact resistances between measuring terminal E and tested item do not influence the measurement.

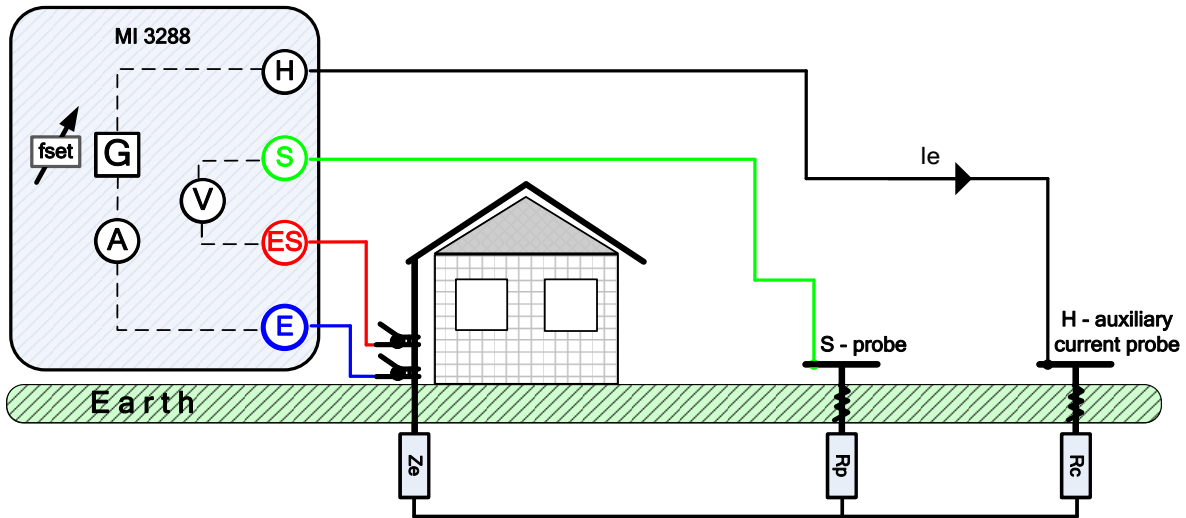

Figure 11.12: 4 – pole example

During the measurement a sinusoidal current I_e is injected into the earth through an auxiliary current probe (H). The impedance of the auxiliary probe (H) should be as low as possible in order to inject a high test current. The impedance R_c can be decreased by using more probes in parallel. A higher injected current improves the immunity against spurious earth currents. The differential voltage drop is measured by auxiliary potential probe (S) and (ES) terminal. The earth impedance Z_e is determined from the voltage/current ratio.

In the example following earth impedance is measured:

$$Z_e = \frac{U_{S-ES} [V]}{I_e [A]} = [\Omega]$$

where:

- Z_e Earth impedance
- R_e Earth resistance (excluding reactance)
- R_c Impedance of auxiliary current probe (H)
- R_p Impedance of auxiliary potential probe (S)
- I_e Injected test current
- U_{S-ES} Test voltage between S and ES terminal
- f_{set} Test frequency

Refer to **Appendix C – Functionality and placing of test probes** for more information how to place the earth auxiliary current (H) and potential probe (S).

Test can be started from the 4 - pole measurement window. Before carrying out a test, the following parameters (Test Mode, Test Voltage, Test Frequency, Distance and Limit (Z_e)) can be edited.

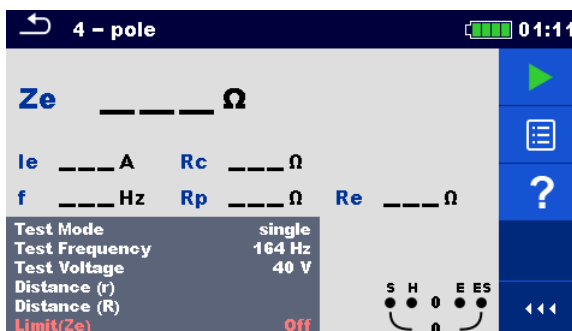

Figure 11.13: 4 - pole measurement menu

Test parameters for 4 – pole:

Test Mode	Test mode: [single]
Test Frequency	Set test frequency: [55 Hz, 82 Hz, 94 Hz, 105 Hz, 111 Hz, 128 Hz, 164 Hz]
Test Voltage	Set test voltage: [20 V or 40 V]
Distance (r)	Distance between E and S probe (user defined).
Distance (R)	Distance between E and auxiliary earth rod H (user defined).
Limit (Ze)	Limit value selection: [OFF, 0.1 Ω – 5.00 kΩ]

4-pole measurement procedure:

- Select the 4-pole measurement function.
- Set the test parameters (voltage, frequency, distance and limit).
- Connect the test leads to the instrument and to the test object.
- Press the Run key to start the measurement.
- Wait until the test result is displayed on the screen.
- Save results (optional).

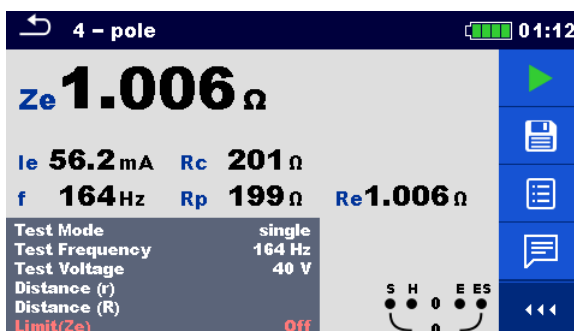

Figure 11.14: Example of 4-pole measurement result

Notes:

- Consider displayed warnings when starting the measurement!
- High noise currents and voltages in earth could influence the measurement results. The tester displays the “noise” warning in this case.

Notes (Probes):

- High impedance of S and H probes could influence the measurement results. In this case, “Rp” and “Rc” warnings are displayed.
- Probes must be placed at a sufficient distance from the measured object.

11.3.4 Selective (Iron Clamp) measurement

This measurement is applicable for measuring selective earth resistances of individual earthing points in an earthing system. The earthing rods do not need to be disconnected during measurement. 4-pole wiring is used for this measurement.

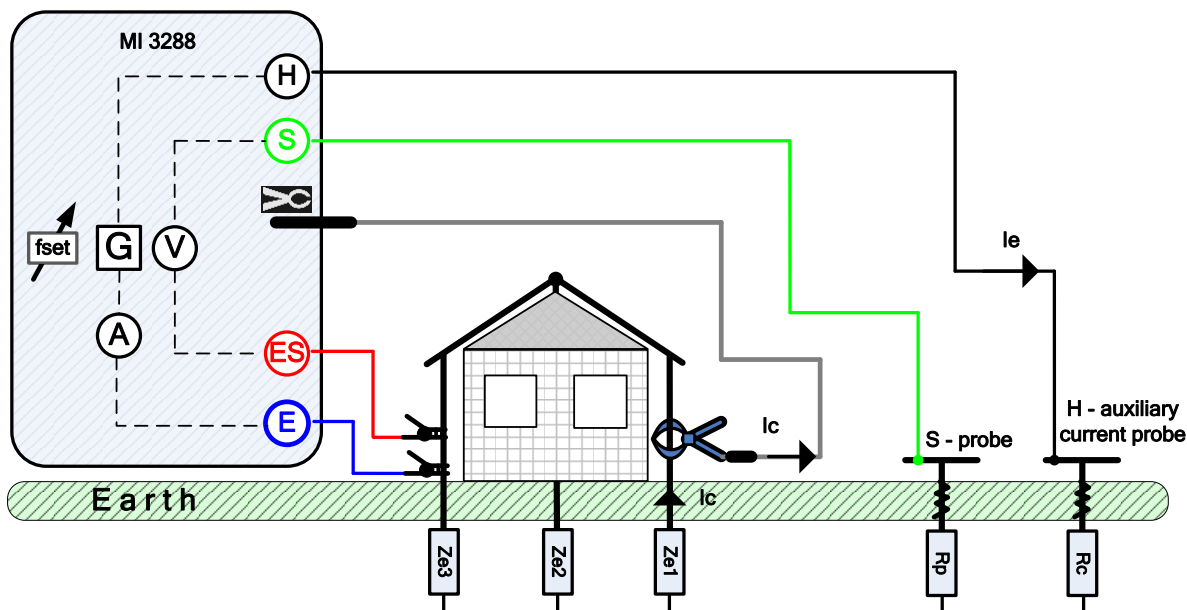

Figure 11.15: Selective (Iron Clamp) example

During the measurement a sinusoidal current I_e is injected into the earth through an auxiliary current probe (H). The impedance of the auxiliary probe (H) should be as low as possible in order to inject a high test current. The impedance R_c can be decreased by using more probes in parallel. A higher injected current improves the immunity against spurious earth currents. The voltage drop is measured by auxiliary potential probe (S) and (ES) terminal. The selective current I_c is measured through the earthing electrode (Z_{e1}) selected by the user. The selected earth impedance Z_{sel} is determined from the voltage/current (external current clamp – I_c) ratio. According to the example selective (individual) earth impedance is measured:

$$Z_{sel} = \frac{U_{S-ES}[V]}{I_c[A]*N} = \frac{U_{S-ES}[V]}{I_{Ze1}[A]} = [\Omega] \quad I_c = \frac{Z_{e1}||Z_{e2}||Z_{e3}}{Z_{e1}} * I_e = [A]$$

where:

- Z_{sel} Selected Earth impedance
- Z_{e1-3} Earth impedance
- R_c Impedance of auxiliary current probe (H)
- R_p Impedance of auxiliary potential probe (S)
- I_e Injected test current
- I_c Measured current with Iron clamp
- U_{S-ES} Test voltage between S and ES terminal
- N Turn ratio of current clamps (depending on the model)
- f_{set} Test frequency

Refer to **Appendix C – Functionality and placing of test probes** for more information how to place the earth auxiliary current (H) and potential probe (S).

Test can be started from the Selective (Iron Clamp) measurement window. Before carrying out a test the following parameters (Test Mode, Clamp Type, Test Frequency, Distance and Limit (Z_{sel})) can be edited.

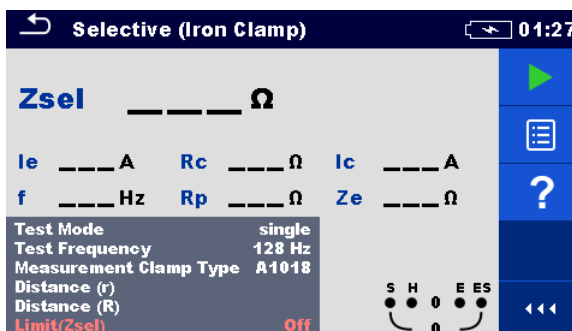

Figure 11.16: Selective (Iron Clamp) measurement menu

Test parameters for Selective (Iron Clamp):

Test Mode	Test mode: [single]
Test Frequency	Set test frequency: [55 Hz, 82 Hz, 94 Hz, 105 Hz, 111 Hz, 128 Hz, 164 Hz]
Clamp type	Clamp type: [A1281]
Distance (r)	Distance between E and S probe (user defined).
Distance (R)	Distance between E and auxiliary earth rod H (user defined).
Limit (Zsel)	Limit value selection: [OFF, Custom, 0.1 Ω – 5.00 kΩ]

Selective (Iron Clamp) measurement procedure:

- Select the Selective (Iron Clamp) measurement function.
- Set the test parameters (frequency, distance and limit).
- Connect the test leads and clamp to the instrument and to the test object.
- Press the Run key to start the measurement.
- Wait until the test result is displayed on the screen.
- Save results (optional).

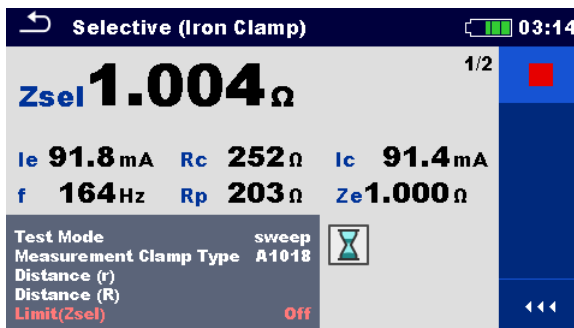

Figure 11.17: Example of Selective (Iron Clamp) measurement result

Notes:

- Consider displayed warnings when starting the measurement!
- High noise currents and voltages in earth could influence the measurement results. The tester displays the “noise” warning in this case.

Notes (Probes):

- High impedance of S and H probes could influence the measurement results. In this case, “Rp” and “Rc” warnings are displayed.
- Probes must be placed at a sufficient distance from the measured object.



11.3.5 2 Clamps measurement

This measurement system is used when measuring earth impedances of grounding rods, cables, under- earth connections, etc. The measuring method needs a closed loop to be able to generate test currents. It is especially suitable for use in urban areas because there is usually no possibility to place the test probes.

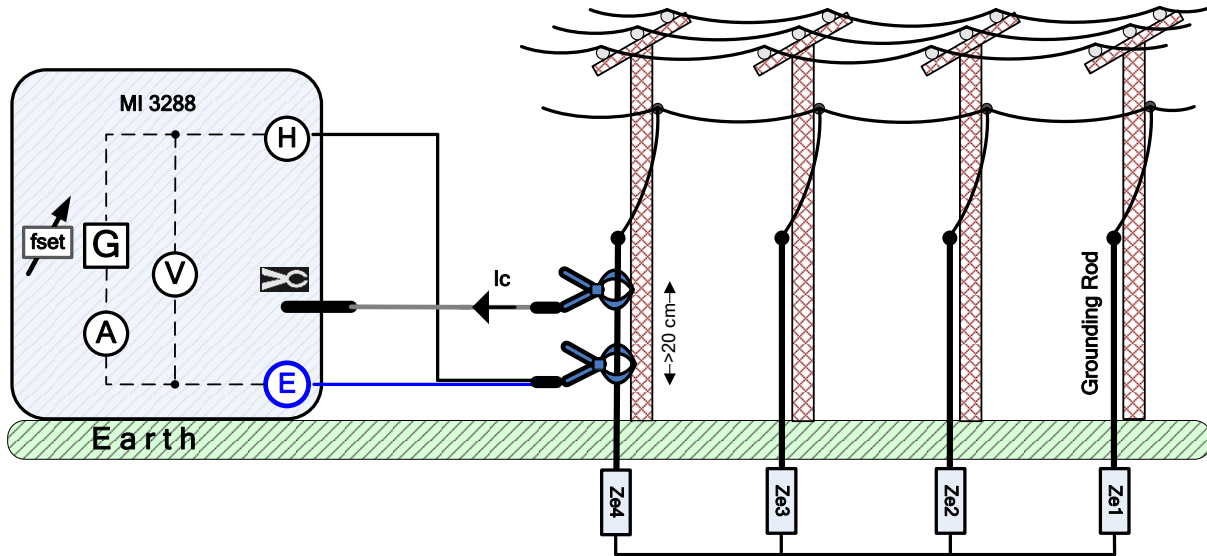

Figure 11.18: 2 Clamps example

The driver (generator) clamp injects a voltage in the earthing system. The injected voltage generates a test current in the loop. If the total loop earth impedance of the electrodes Z_{e1} , Z_{e2} , Z_{e3} and Z_{e4} connected in parallel is much lower than the impedance of tested electrode Z_{e4} , then the result can be considered as $\approx Z_{e4}$. Other individual impedance can be measured by embracing other electrodes with the current clamps.

According to the example individual earth impedance is measured:

$$Z_{e4} + (Z_{e1} || Z_{e2} || Z_{e3}) = \frac{U_{H-E} [V] * \frac{1}{N}}{I_c [A]} = [\Omega]$$

where:

- Z_{e1-e4} Earth impedance
- I_c Measured current with Iron clamp
- U_{H-E} Test voltage between H and E terminal
- N Driver (generator) clamp transformation ratio (depending on the clamp model)
- f_{set} Test frequency

Note:

- 2 Clamps earth resistance test is sometimes called “loop resistance test”.

Test can be started from the 2 Clamps measurement window. Before carrying out a test the following parameters (Measurement Clamp Type, Test Frequency, Generator Clamp Type and Limit (Ze)) can be edited.

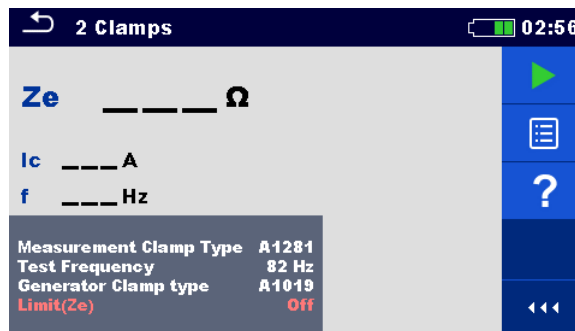

Figure 11.19: 2 Clamps measurement menu

Test parameters for 2 Clamps:

Measurement Clamp type	Measurement clamp type: [A1281]
Test Frequency	Set test frequency: [82 Hz, 94 Hz, 105 Hz, 111 Hz, 128 Hz, 164 Hz]
Generator Clamp type	Generator clamp type: [A1019]
Limit (Ze)	Limit value selection [OFF, Custom, 0.1 Ω – 40 Ω]

2 Clamps measurement procedure:

- Select the 2 Clamps measurement function.
- Set the test parameters (frequency and limit).
- Connect the clamps to the instrument and to the test object.
- Press the Run key to start the measurement.
- Wait until the test result is displayed on the screen.
- Press the Run key again to stop the measurement.
- Save results (optional).

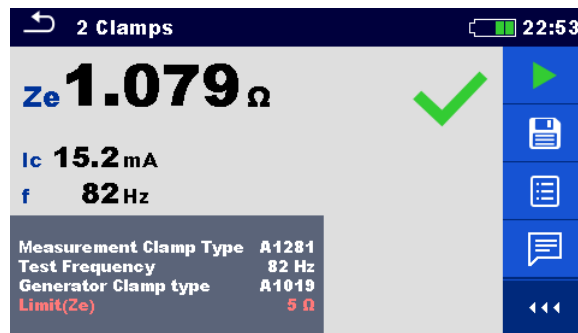

Figure 11.20: Example of 2 Clamps measurement result

Notes:

- Consider displayed warnings when starting the measurement!
- High noise currents and voltages in earth could influence the measurement results. The tester displays the “noise” warning in this case.

11.4 Specific Earth Resistance Measurements[ρ]

The measurement is carried out in order to assure more accurate calculation of earthing systems e.g., for high-voltage distribution towers, large industrial plants, lightning systems etc. AC test voltage should be used for the measurement. DC test voltage is not suitable because of possible electro-chemical processes in the measured ground material. Specific Earth Resistance value is expressed in Ωm or Ωft, its absolute value depends on structure of the ground material.

Specific Earth Resistance	Measurement	Test Mode	Distance	Limit	Filter	Test Voltage
ρ	Wenner Method	single	m / ft	yes	FFT	20 / 40 V
	Schlumberger Method	single	m / ft	yes	FFT	20 / 40 V

Table 11.6: Available Specific Earth Resistance measurements in the MI 3288

11.4.1 General on specific earth

What is Specific Earth Resistance?

It is the resistance of ground material shaped as a cube 1 × 1 × 1 m, where the measurement electrodes are placed at the opposite sides of the cube, see the figure below.

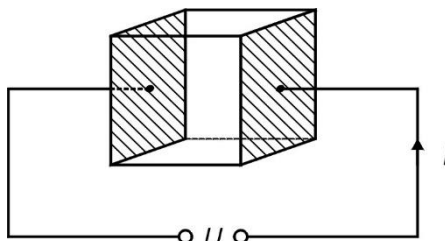

Figure 11.21: Presentation of Specific Earth Resistance

The table below represents indicative values of Specific Earth Resistances for a few typical ground materials.

Type of ground material	Specific Earth Resistance in Ωm	Specific Earth Resistance in Ωft
sea water	0.5	1.6
lake or river water	10 – 100	32.8 – 328
ploughed earth	90 – 150	295 – 492
concrete	150 – 500	492 – 1640
wet gravel	200 – 400	656 – 1312
fine dry sand	500	1640
lime	500 – 1000	1640 – 3280
dry gravel	1000 – 2000	3280 – 6562
stony ground	100 – 3000	328 – 9842

Table 11.7: Typical values of Specific Earth Resistances vs type of ground material

11.4.2 Wenner method measurement

Place the four earth probes on a straight line, at a distance **a** from one another and at a depth **b** < **a/20**. Distance **a** must be between 0.1 m and 49.9 m. Connect the 4-wire Earth test cable to the MI 3288 and terminals H, S, ES, and E using the probe wires to the probes.

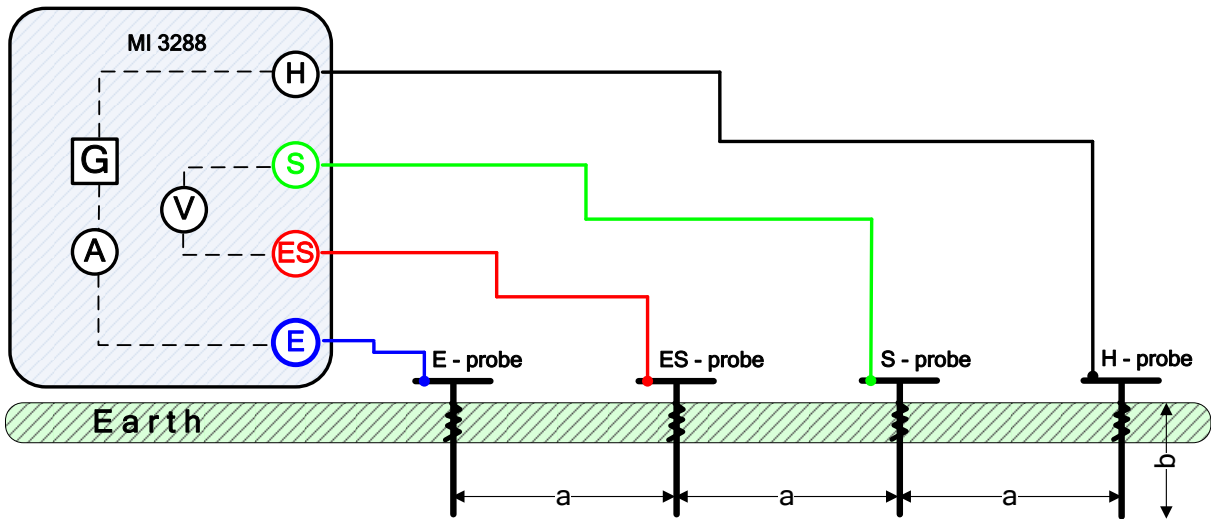

Figure 11.22: Wenner method example

Wenner method with equal distances between test probes:

$$b < \frac{a}{20}$$

$$\rho_{wenner} = 2 \cdot \pi \cdot a \cdot R_e = [\Omega m]$$

where:

- R_e Measured earth resistance in 4-pole method
- a Distance between earth probes
- b Depth of earth probes
- π Number π is a mathematical constant (3.14159)

Test can be started from the Wenner method measurement window. Before carrying out a test the following parameters (Test Voltage, Length unit, Distance a and Limit (ρ)) can be edited.

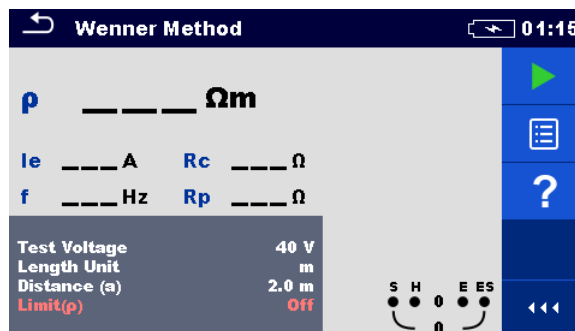

Figure 11.23: Wenner method measurement menu

Test parameters for Wenner method:**Test Voltage** Set test voltage: [20 V or 40 V]**Length Unit** Set the length unit: [m or ft]**Distance a** Set the distance between earth probes: [0.1 m – 49.9 m] or [1 ft – 200 ft]**Limit (ρ)** Limit value selection: [OFF, 0.1 Ω m – 900 k Ω m]Limit value selection: [OFF, 1 Ω ft – 900 k Ω ft]**Wenner method measurement procedure:**

- Select the Wenner method measurement function.
- Set the test parameters (voltage, unit, distance and limit).
- Connect the test leads to the instrument and to the test object.
- Press the Run key to start the measurement.
- Wait until the test result is displayed on the screen.
- Save results (optional).

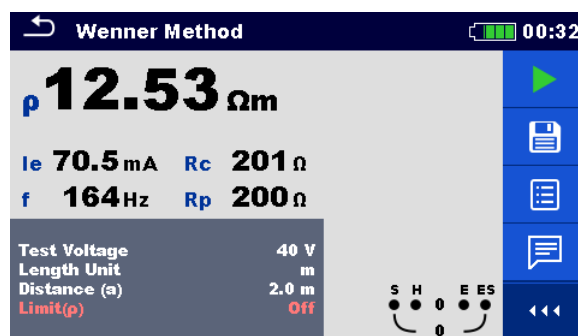

Figure 11.24: Example of Wenner method measurement result

Notes:

- Consider displayed warnings when starting the measurement!
- High noise currents and voltages in earth could influence the measurement results. The tester displays the “noise” warning in this case.

Note (Probes):

- High impedance of S and H probes could influence the measurement results. In this case, “Rp” and “Rc” warnings are displayed.

11.4.3 Schlumberger method measurement

Place the two earth probes (ES and S) at a distance **d** from one another and place the second two earth probes (E and H) at a distance **a** from ES and S probes. All probes must be placed on a straight line and to a depth of **b**, considering the condition **b << a,d**. Distance **d** must be between 0.1 m and 24.9 m and the distance **a** must be **a > 2*d**. Connect the 4-wire Earth test cable to the MI 3288 and terminals H, S, ES, and E using the probe wires to the probes.

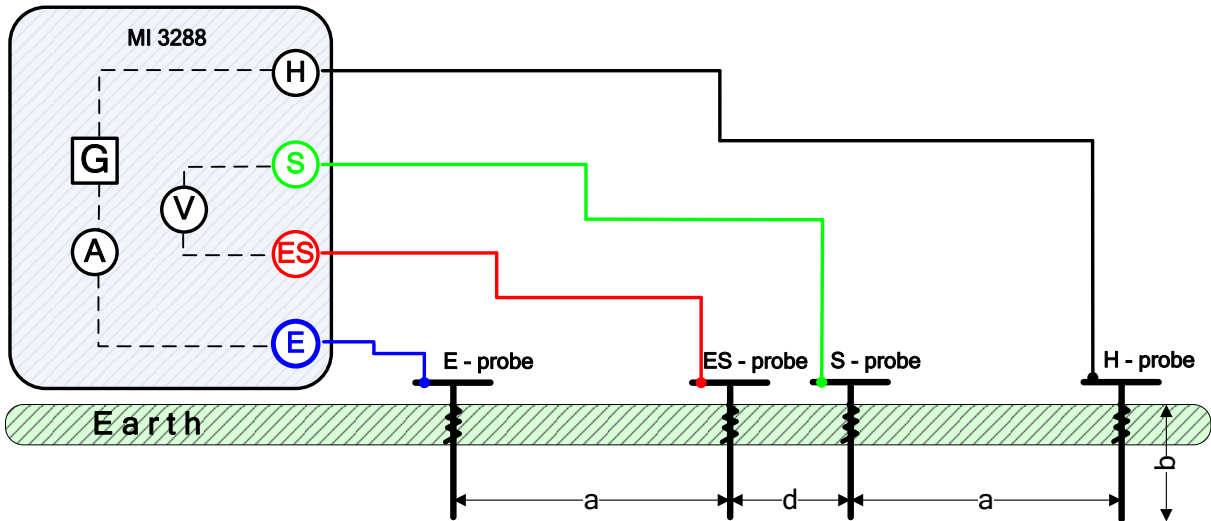

Figure 11.25: Schlumberger method example

Schlumberger method with unequal distances between test probes:

$b \ll a, d \quad a > 2 * d$

$$\rho_{schlumberger} = \frac{\pi \cdot a \cdot (a + d) \cdot R_e}{d} = [\Omega m]$$

where:

- R_e Measured earth resistance in 4-pole method
- a Distance between earth probes (E, ES) and (H, S)
- d Distance between earth probes (S, ES)
- b Depth of earth probes
- π Number π is a mathematical constant (3.14159)

Test can be started from the Schlumberger method measurement window. Before carrying out a test the following parameters (Test Voltage, Unit, Distance a, Distance d and Limit (ρ)) can be edited.

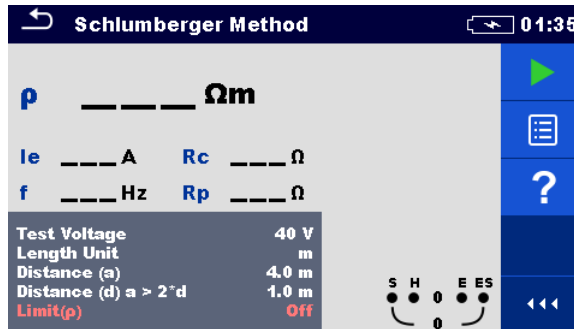

Figure 11.26: Schlumberger method measurement menu

Test parameters for Schlumberger method:

Test Voltage	Set test voltage: [20 V or 40 V]
Length Unit	Set the length unit: [m or ft]
Distance a	Set the distance between earth electrodes: [0.1 – 49.9 m] or [1 – 200 ft]
Distance d	Set the distance between earth electrodes: [0.1 – 49.9 m] or [1 – 200 ft]
Limit (ρ)	Limit value selection: [OFF, 0.1 Ω m – 900 k Ω m] Limit value selection: [OFF, 1 Ω ft – 900 k Ω ft]

Schlumberger method measurement procedure:

- Select the Schlumberger method measurement function.
- Set the test parameters (voltage, unit, distances and limit).
- Connect the test leads to the instrument and to the test object.
- Press the Run key to start the measurement.
- Wait until the test result is displayed on the screen.
- Save results (optional).

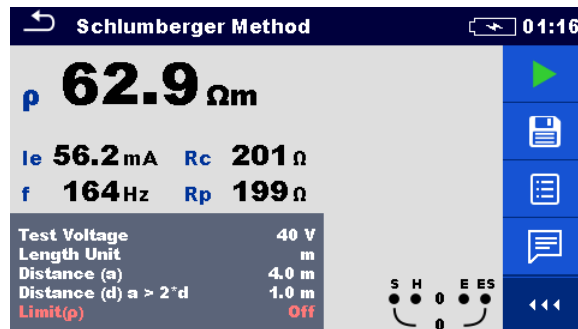

Figure 11.27: Example of Schlumberger method measurement result

Notes:

- Consider displayed warnings when starting the measurement!
- High noise currents and voltages in earth could influence the measurement results. The tester displays the “noise” warning in this case.

Note (Probes):

- High impedance of S and H probes could influence the measurement results. In this case, “Rp” and “Rc” warnings are displayed.

11.5 Earth Potential [Us]

An earthing electrode / grid deployed into ground have a certain resistance, depending on its size, surface (oxides on the metal surface) and the soil resistivity around the electrode. The earthing resistance is not concentrated in one point but is distributed around the electrode. Correct earthing of exposed conductive parts assures that the voltage on them stays below dangerous level in case of a fault.

If a fault happens a fault current will flow through the earthing electrode. A typical voltage distribution occurs around the electrode (the “voltage funnel”). The largest part of the voltage drop is concentrated around the earth electrode. *Figure 11.28* shows how fault, step and contact voltages occur as a result of fault currents flowing through the earthing electrode / grid in the ground.

Fault currents close to power distribution objects (substations, distribution towers, plants) can be very high, up to 200 kA. This can result in dangerous step and contact voltages. If there are underground metal connections (intended or unknown) the voltage funnel can get atypical forms and high voltages can occur far from the point of failure. Therefore, the voltage distribution in case of a fault around these objects must be carefully analysed.

In the example below step and touch voltage are illustrated:

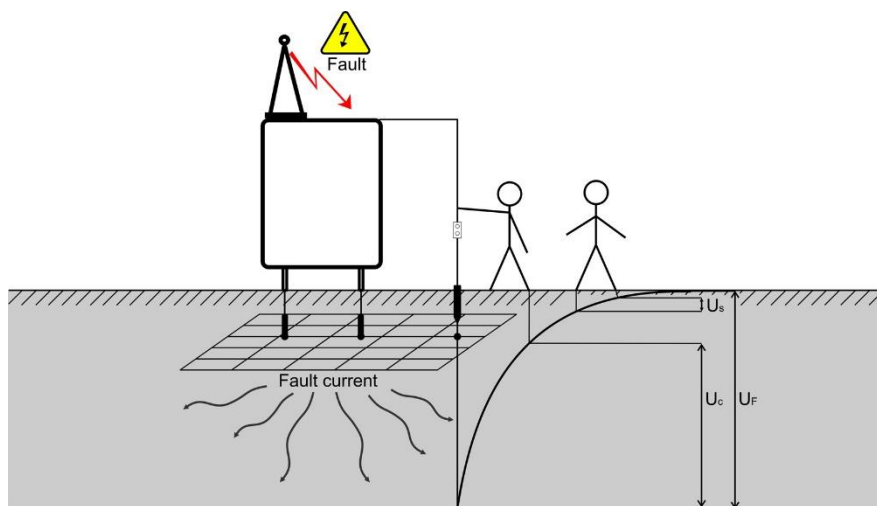

Figure 11.28: Dangerous voltages on a faulty earthing system

where:

- Us Step Voltage in case of a fault current
- Uc Contact or Touch Voltage in case of a fault current
- Uf Fault voltage

Standard IEC 61140 defines following maximum allowed time / contact voltage relations:

Maximum time of exposure	Voltage
>5 s to ∞	UC ≤ 50 VAC or ≤ 120 VDC
< 0,4 s	UC ≤ 115 VAC or ≤ 180 VDC
< 0,2 s	UC ≤ 200 VAC
< 0,04 s	UC ≤ 250 VAC

Table 11.8: Maximum time durations vs fault voltage

For a longer exposure, the touch voltages must stay below 50 V.

11.5.1 Step and Touch Measurement

Step Voltage

The measurement is performed between two ground points at a distance of 1 m as shown on Figure. The metal plates (S2053) simulate the feet. The voltage between the probes is measured by a voltmeter with an external resistance of 1 kΩ (adapter A 1597) that simulates the body resistance.

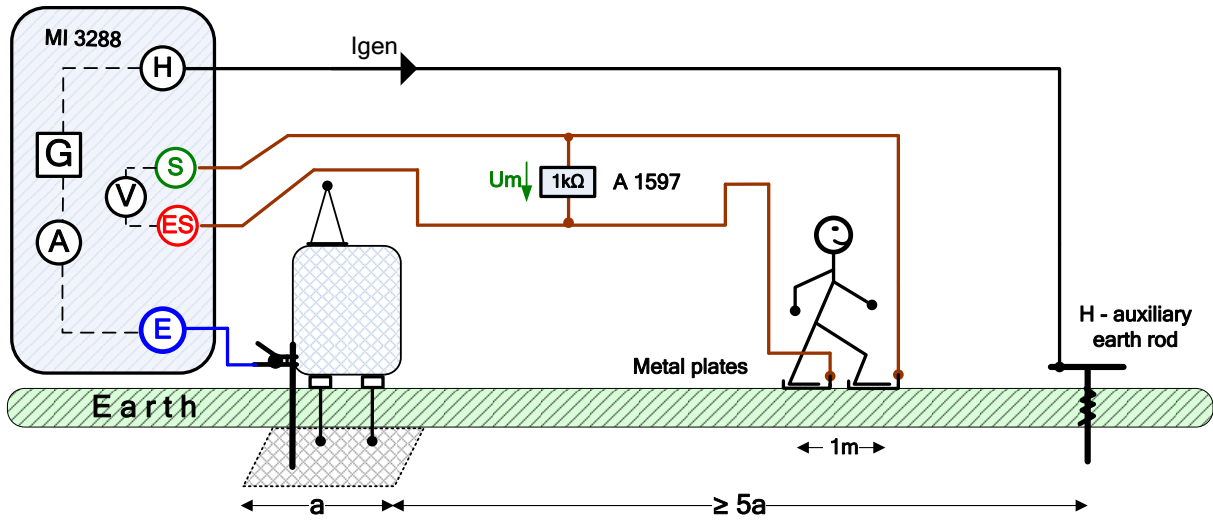

Figure 11.29: Step Voltage example

Touch Voltage

The measurement is performed between an earthed accessible metal part and ground 1 m apart as shown on Figure. The voltage between the metal plates (S2053) is measured by a voltmeter with an external resistance of 1 kΩ (adapter A 1597) that simulates the body resistance.

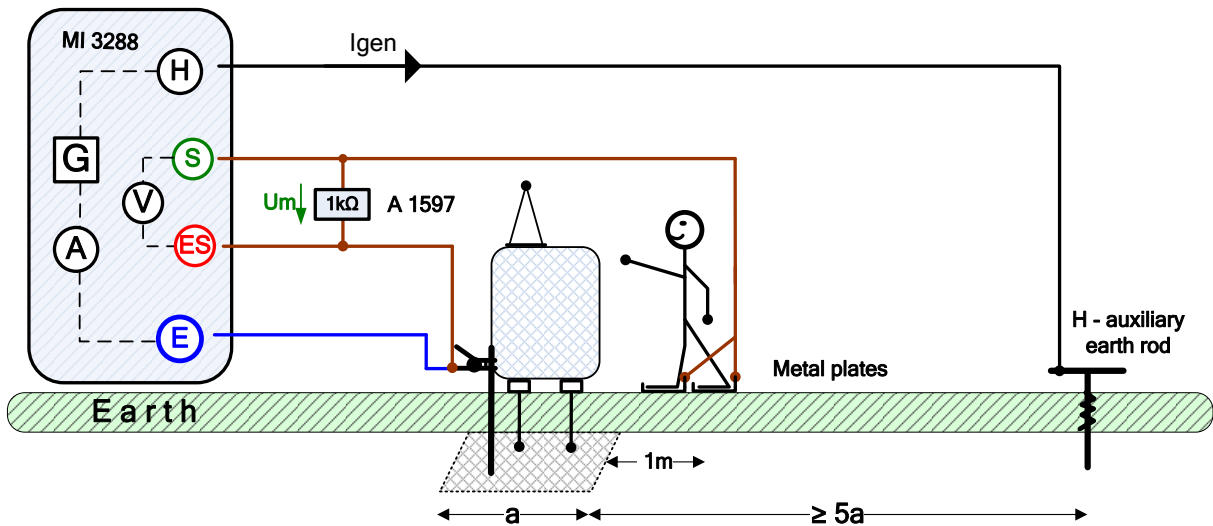

Figure 11.30: Touch Voltage example

During the measurement a sinusoidal current I_{gen} is injected into the earth through an auxiliary probe (H). The resistance of the auxiliary probe (H) should be as low as possible in order to inject a high test current. The resistance R_c can be decreased by using more probes in parallel. A higher injected current improves the immunity against spurious earth currents. The voltage drop is measured with the help of the high sensitive V - meter. As the test current is usually only a small fraction of the highest fault current, the measured voltages must be up scaled according to following equation:

$$U_s = U_m \cdot \frac{I_{fault}}{I_{gen}}$$

where:

- U_s Calculated Step or Touch Voltage in case of a fault current
- U_m Test voltage drop V-meter
- I_{fault} Set fault current voltage (maximal earth current in case of a fault)
- I_{gen} Test current injected between H (C1) and E (C2) terminal

Test can be started from the Step and Touch window.

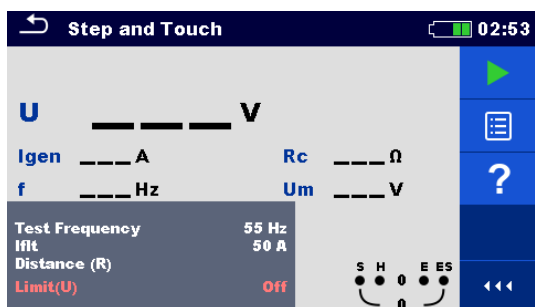

Figure 11.31: Step and Touch menu

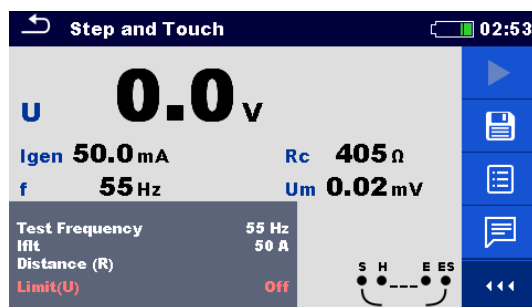

Figure 11.32: Example of Step and Touch menu result

Test parameters for Step and Touch measurement:

Test Frequency	Set test frequency: [55 Hz, 82 Hz]
Iflt	Fault current [1 A – 200 kA].
Distance R	Distance between E and auxiliary earth rod H (user defined).
Limit (U)	Limit value selection: [OFF, 25 V – 400 V]

Step and Touch measurement procedure:

- Select the Step and Touch measurement.
- Connect the test leads to the instrument and to the test object.
- Press the Run key to start the measurement.
- Wait until the test result is displayed on the screen.
- Save results (optional).

Notes:

- Consider displayed warnings when starting the measurement!
- High noise currents and voltages in earth could influence the measurement results. The tester displays the “noise” warning in this case.

Notes (Probes):

- High impedance of H probe could influence the measurement results.
- Probes must be placed at a sufficient distance from the measured object.

11.6 DC Resistance [R]

DC Resistance	Measurement	Test Mode	Test Method	Limit	Filter	Test Current
R	Ω - Meter (200mA)	single	2-wire 4-wire	yes	DC	200 mA
	Ω - Meter (7mA)	cont.	2-wire	yes	DC	7 mA

Table 11.9: Available DC Resistance measurements in the MI 3288

Four wire Kelvin method

When measuring resistance < 20 Ω it is advisable to use a four-wire measurement technique (Figure 11.33), for achieving high accuracy. By using this type of measurement configuration, the test lead resistance is not included in the measurement, and the need for lead calibrating and balancing is eliminated.

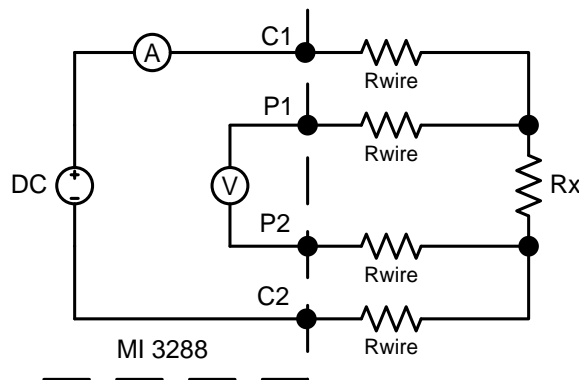

Figure 11.33: Four wire Kelvin method

The measuring current is passed through the unknown resistance Rx using the C1 and C2 probes. The placing of these probes is not critical but should always be outside the P1 and P2 probes. The Voltage drop across the Rx is measured across P1 and P2 and these should be placed exactly at the points to be measured.

Note about poor connection:

- Most measurement errors are caused by poor or inconsistent connection of the object under test. It is essential to ensure that the device under test has clean, oxide-free and dirt-free contacts. High resistance connection will cause errors and may prevent the selected current to flow, because of the high resistance of C1 - C2 loop.

Note:

- Ohm's law** states that the current through a conductor between two points is directly proportional to the potential difference or voltage across the two points, and inversely proportional to the resistance between them. The mathematical equation that describes this relationship is:

$$I[\text{Amper}] = \frac{U[\text{Volt}]}{R[\text{Ohm}]} \Rightarrow Rx[\text{Ohm}] = \frac{U[\text{Volt}]}{I[\text{Amper}]}$$

Note about thermal EMF:

- A junction between two different metals produces a voltage related to a temperature difference (thermocouple). MI 3288 eliminates the thermal EMF effect by measuring resistance in both directions of current flow +I and -I.

11.6.1 Ω - Meter (200 mA) Measurement

The resistance measurement is performed in order to assure that the protective measures against electric shock through earth bond connections are effective. The resistance measurement is performed with DC current of 200 mA.

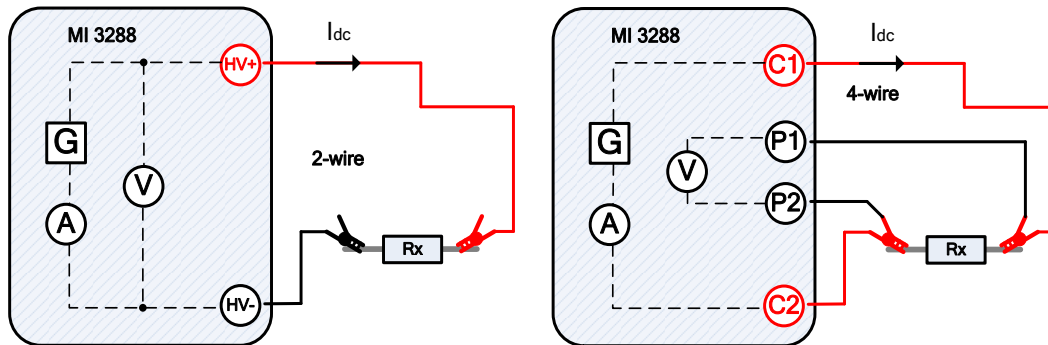

Figure 11.34: Ω - Meter (200 mA) example (2 and 4-wire test method)

In the example following resistance is measured:

$$R = \frac{U_{DC} [V]}{I_{DC} [A]} = [\Omega]$$

where:

- R Resistance
- R+ Result at positive test polarity
- R- Result at negative test polarity
- I_{dc} Injected DC test current between C1 and C2 or HV+ and HV-terminals
- U_{dc} Measured DC voltage between C1 and C2 or HV+ and HV-terminals

Test can be started from the Ω - Meter (200 mA) measurement window. Before carrying out a test the following parameters (Test Method and Limit (R)) can be edited.

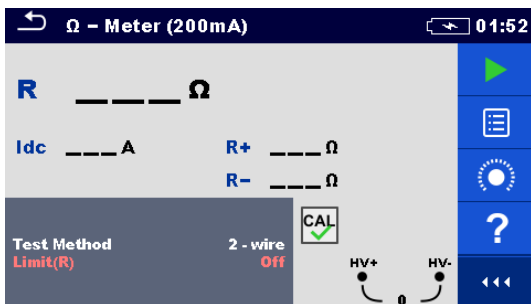

Figure 11.35: Ω - Meter (200 mA) measurement menu

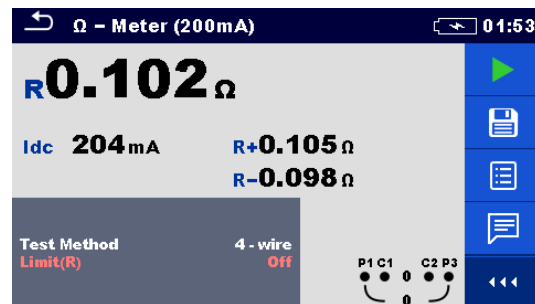

Figure 11.36: Example of Ω - Meter (200 mA) measurement result (4-wire test method)

Test parameters for Ω - Meter (200 mA):

Test Method Set test method: [2 - wire, 4 - wire]

Limit (R) Limit value selection: [OFF, Custom, 0.1 Ω – 40 Ω]

Ω - Meter (200 mA) measurement procedure:

- Select the Ω - Meter (200 mA) measurement function.
- Set the test parameters (test method, limit).
- Connect the test leads to the instrument.
- Compensate the leads if using 2-wire test method (optional).
- Connect the test leads to the test object.
- Press the Run key to start the measurement.

- Wait until the test result is displayed on the screen.
- Save results (optional).

Note:

- Consider displayed warnings when starting the measurement!

11.6.2 Ω - Meter (7 mA) Measurement

In general, this function serves as standard Ω - meter with a low testing current. The measurement is performed continuously without polarity reversal. This function can also be applied for testing continuity of inductive components.

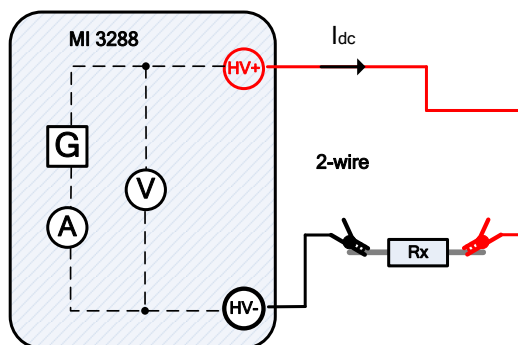

Figure 11.37: Ω - Meter (7 mA) example

In the example following resistance is measured:

$$R = \frac{U_{DC} [V]}{I_{DC} [A]} = [\Omega]$$

where:

- R Resistance
- I_{dc} Injected test current DC
- U_{dc} Measured DC voltage between HV+ and HV- terminals

Test can be started from the Ω - Meter (7mA) measurement window. Before carrying out a test the following parameters (Sound and Limit (R)) can be edited.

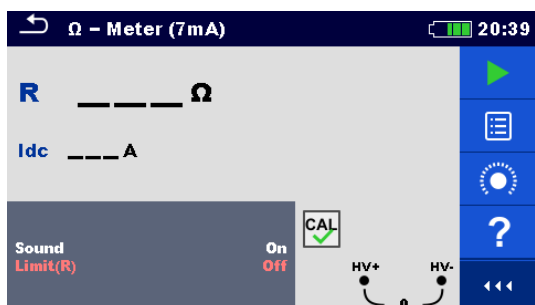

Figure 11.38: Ω - Meter (7 mA) measurement menu

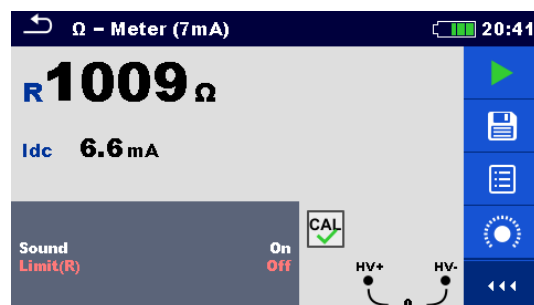

Figure 11.39: Example of Ω - Meter (7 mA) measurement result

Test parameters for Ω - Meter (7 mA):

- Sound** [On, Off]
- Limit (R)** Limit value selection: [OFF, Custom, 1 Ω – 15.0 kΩ]

Ω - Meter (7 mA) measurement procedure:

- Select the Ω - Meter (7 mA) measurement function.
- Set the test parameters (sound and limit).
- Connect the test leads to the instrument.
- Compensate the leads (optional).
- Connect the test leads to the test object.

- Press the Run key to start the measurement.
- Wait until the test result is displayed on the screen.
- Press the Run key to stop the measurement.
- Save results (optional).

Note:

- Consider displayed warnings when starting the measurement!**

11.6.2.1 Compensation of test leads resistance

This chapter describes how to compensate test leads resistance in both continuity functions (Ω - Meter 200 mA and 7 mA). Compensation is required in 2-wire mode to eliminate the influence of test leads resistance and the internal resistances of the instrument on the measured resistance. The lead compensation is therefore a very important feature to obtain correct result. Once

compensation has been performed, the compensation icon  appears on the screen.



Circuits for compensating the resistance of test leads

Figure 11.40: Shorted test leads

Compensation of test leads resistance procedure:

- Select the Ω - Meter 200 mA or 7 mA function.
- Connect test cable to the instrument and short the test leads together see **Figure 11.40**.
- Press the  icon to compensate leads resistance.

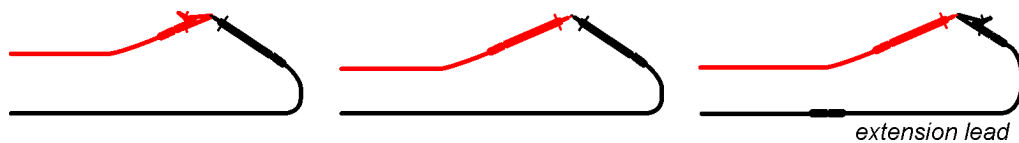
Note:

- The limit value for lead compensation is 5 Ω .**

11.7 Insulation Resistance Measurement [Riso]

The purpose of insulation tests

Insulating materials are important parts of almost every electrical product. The material's properties depend not only on its compound characteristics but also on temperature, pollution, moisture, ageing, electrical and mechanical stress, etc. Safety and operational reliability require the regular maintenance and testing of the insulation material to ensure it is kept in good operational condition. High voltage tests are used to test insulating materials.

DC vs. AC testing voltage

Testing with a DC voltage is widely accepted as being useful as testing with AC and / or pulsed voltages. DC voltages can be used for breakdown tests especially where high capacitive leakage currents interfere with measurements using AC or pulsed voltages. DC is mostly used for insulation resistance measurement tests. In this type of test, the voltage is defined by the appropriate product application group. This voltage is lower than the voltage used in the withstanding voltage test so the tests can be applied more frequently without stressing the test material.

Typical insulation tests

In general, insulation resistance tests consist of the following possible test procedures:

- ❑ Simple insulation resistance measurement also called a spot test;
- ❑ Measurement of the relationship between voltage and insulation resistance;
- ❑ Measurement of the relationship between time and insulation resistance
- ❑ Test of residual charge after the dielectric discharge.

The results of this test can indicate whether the replacement of the insulation system is required.

Typical examples of where testing insulation resistance and its diagnosis are recommended are transformer and motor insulation systems, cables and other electrical equipment.

Electrical representation of insulating material

The Figure 11.41 represents the equivalent electrical circuit of an insulating material.

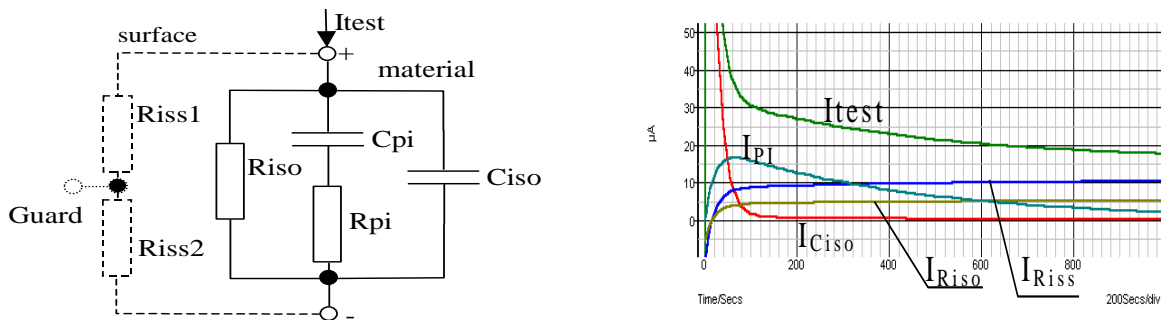

Figure 11.41: Equivalent electrical representation of Insulating material

where:

- R_{iss1} and R_{iss2} Surface resistivity (position of optional guard connection)
- R_{iso} Actual insulation resistance of material
- C_{iso} Capacitance of material
- C_{pi} , R_{pi} Represents polarization effects
- I_{test} Overall test current ($I_{test} = I_{PI} + I_{RISO} + I_{RISS}$)
- I_{PI} Polarization absorption current
- I_{RISO} Actual insulation current
- I_{RISS} Surface leakage current

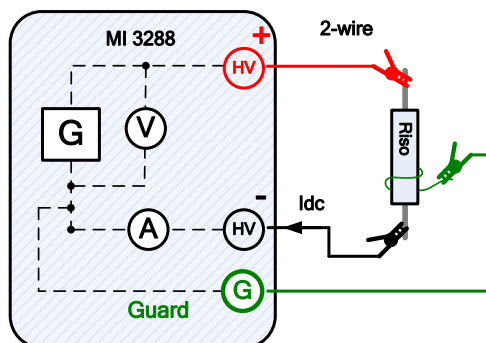

Figure 11.42: Insulation resistance example (IR, DD, SV, WS - Test)

In the example following insulation resistance is measured:

$$R_{iso} = \frac{U_{DC} [V]}{I_{DC} [A]} = [\Omega]$$

where:

- R_{iso} Insulation Resistance
- I_{dc}..... Measured leakage current between HV+ and HV- terminals
- U_{dc} Measured test voltage between HV+ and HV- terminals

11.7.1 Insulation Resistance measurement

Test can be started from the Insulation Resistance window. Before carrying out a test the following parameters (test voltage, timer, averaging and limit) can be edited.

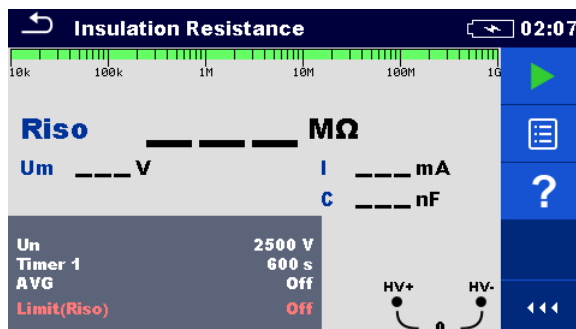

Figure 11.43: Insulation Resistance measurement menu

Test parameters for Insulation Resistance:

Un	Set test voltage: [50 V – 1 kV] step 50 V, [1 kV – 2.5 kV] step 100 V
Timer1	Duration of measurement (s): [Custom, 5 s – 600 s]
AVG	Additional averaging of the result value: [OFF, 5, 10, 30, 60]
Limit (Riso)	Limit value selection: [OFF, Custom, 1 MΩ – 500 MΩ]

Insulation Resistance measurement procedure:

- Select the Insulation Resistance measurement function.
- Set the test parameters (test voltage, timer, averaging and limit).
- Connect the test leads to the instrument and to the test object.
- Press the Run key to start the measurement.
- Wait until the test result has stabilized then press the Run key again to stop the measurement or wait for the set timer to run out.
- Wait for the object under test to discharge.
- Save results (optional).

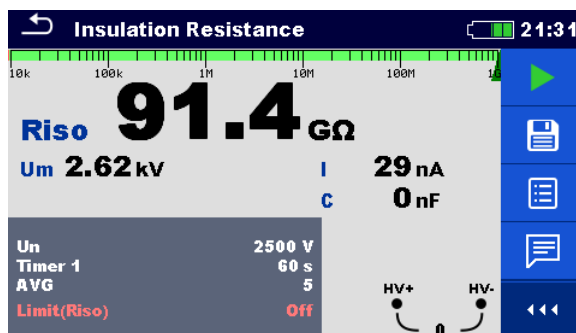

Figure 11.44: Example of Insulation Resistance measurement result



Warnings:

- Refer to Warnings chapter for safety precautions!
- Do not touch the test object during the measurement or before it is fully discharged!
Risk of electric shock!

Notes:

- Consider displayed warnings when starting the measurement!
- A high-voltage warning symbol appears on the display during the measurement to warn the operator of a potentially dangerous test voltage.
- Value of capacitance is measured during the final discharge of the test object.



11.7.2 Diagnostic Test

Diagnostic Test is a long duration test for evaluating the quality of the insulation material under test. The results of this test enable the decision to be made on the preventive replacement of the insulation material. Test can be started from the Diagnostic Test window. Before carrying out a test the parameters can be edited.

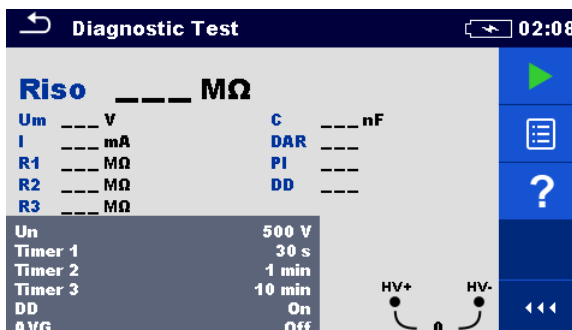

Figure 11.45: Diagnostic Test menu

Test parameters for Diagnostic Test:

Un	Set test voltage: [50 V – 1 kV] step 50 V, and [1 kV – 2.5 kV] step 100 V
Timer1	Duration of measurement (s): [Custom, 5 s – 600 s]
Timer2	Delay for starting PI measurement (min): [Custom, 1 min – 100 min]
Timer3	Duration of measurement (min): [Custom, 1 min – 100 min]
DD	Set dielectric discharge testing: [On, Off]
AVG	Additional averaging of the result value: [OFF, 5, 10, 30, 60]
Limit (Riso)	Limit value selection: [OFF, Custom, 1 MΩ – 500 MΩ]

Diagnostic Test procedure:

- Select the Diagnostic Test function.
- Set the test parameters (test voltage, timers, DD, averaging and limit).
- Connect the test leads to the instrument and to the test object.
- Press the Run key to start the measurement.
- Wait for the set timers to run out or press the Run key again to stop the measurement.

- ❑ Wait for the object under test to discharge.
- ❑ Save results (optional).

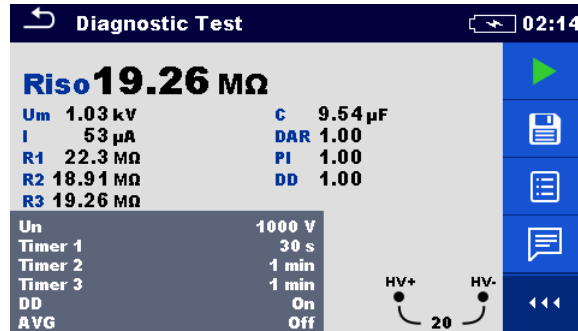

Figure 11.46: Example of Diagnostic Test result



Warnings:

- ❑ Refer to Warnings chapter for safety precautions!
- ❑ Do not touch the test object during the measurement or before it is fully discharged! Risk of electric shock!

Notes:

- ❑ Consider displayed warnings when starting the measurement!
- ❑ A high-voltage warning symbol appears on the display during the measurement to warn the operator of a potentially dangerous test voltage.
- ❑ Value of capacitance is measured during the final discharge of the test object.
- ❑ If enabled, the instrument measures Dielectric Discharge (DD) when the capacitance is within the range of 20 nF to 50 μF.

Timer1, Timer2 and Timer3 are timers with the same starting point. The value of each presents the duration from the start of the measurement. The maximum time is limited to 100 min. The following Figure shows the timer relationships.

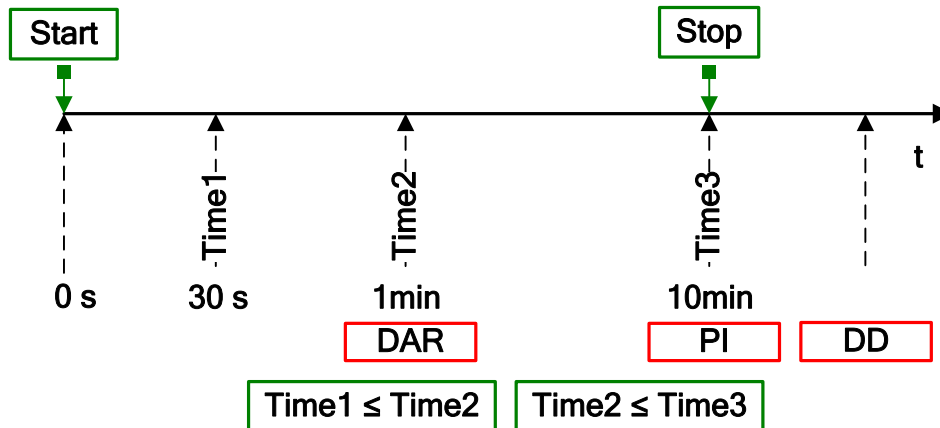

Figure 11.47 Timer relations

Dielectric Absorption Ratio (DAR)

DAR is ratio of Insulation Resistance values measured after 30 s and after 1 minute. The DC test voltage is present during the whole period of the test (also an Insulation Resistance measurement is continually running). At the end, the DAR ratio is displayed:

$$DAR = \frac{R_{iso}(Timer2_(1min))}{R_{iso}(Timer1_(30s))}$$

Some applicable values for DAR (Timer1 = 30 s and Timer2 = 1 min):

DAR value	Tested material status
< 1	Bad insulation
1 ≤ DAR ≤ 1.25	Acceptable insulation
> 1.4	Very good insulation

Note:

- When determining Riso (30 s) pay close attention to the capacitance of the test objects. It has to be charged-up in the first time section (30 s). Approximate maximum capacitance using:

$$C_{max}[\mu F] = \frac{t[s] \times 10^3}{U[V]}$$

Where:

t..... Timer1 (e.g., 30 s).
 U..... Test voltage.

Polarization Index (PI)

PI is the ratio of Insulation Resistance values measured after 1 minute and after 10 minutes. The DC test voltage is present during the whole period of the measurement (an Insulation Resistance measurement is also running). On completion of the test the PI ratio is displayed:

$$PI = \frac{R_{iso}(Timer3_(10min))}{R_{iso}(Timer2_(1min))}$$

Some applicable values for PI (Timer2 = 1 min and Timer3 = 10 min):

PI value	Tested material status
1 – 1.5	Not acceptable (older types)
2 – 4	Considered as good insulation (older types)
4	Modern type of good insulation systems

Note:

- When determining Riso (1 min) pay close attention to the capacitance of the test objects. It has to be charged-up in the first time section (1 min). Approximate maximum capacitance using:

$$C_{max}[\mu F] = \frac{t[s] \times 10^3}{U[V]}$$

where:

t..... Timer2 (e.g., 1 min).
 U..... Test voltage.

Analysing the change in the measured insulation resistance over time and calculating the DAR and PI are very useful maintenance tests of an insulating material.

Dielectric Discharge Testing (DD)

DD is the diagnostic insulation test carried out after the completion of the Insulation Resistance measurement. Typically, the insulation material is left connected to the test voltage for 1 min – 30 min and then discharged before the DD test is carried out. After 1 minute a discharge current is measured to detect the charge re-absorption of the insulation material. A high re-absorption current indicates contaminated insulation (mainly based on moisture):

$$DD = \frac{Idis1min[nA]}{U[V] \times C[\mu F]}$$

where:

Idis 1 min..... Discharging current measured 1 min after regular discharge.

C..... Capacitance of test object.
 U..... Test voltage.

A high re-absorption current shows that the insulation has been contaminated, usually by moisture. Typical values of dielectric discharge are shown in table.

DD value	Tested material status
> 4	Bad
2 – 4	Critical
< 2	God

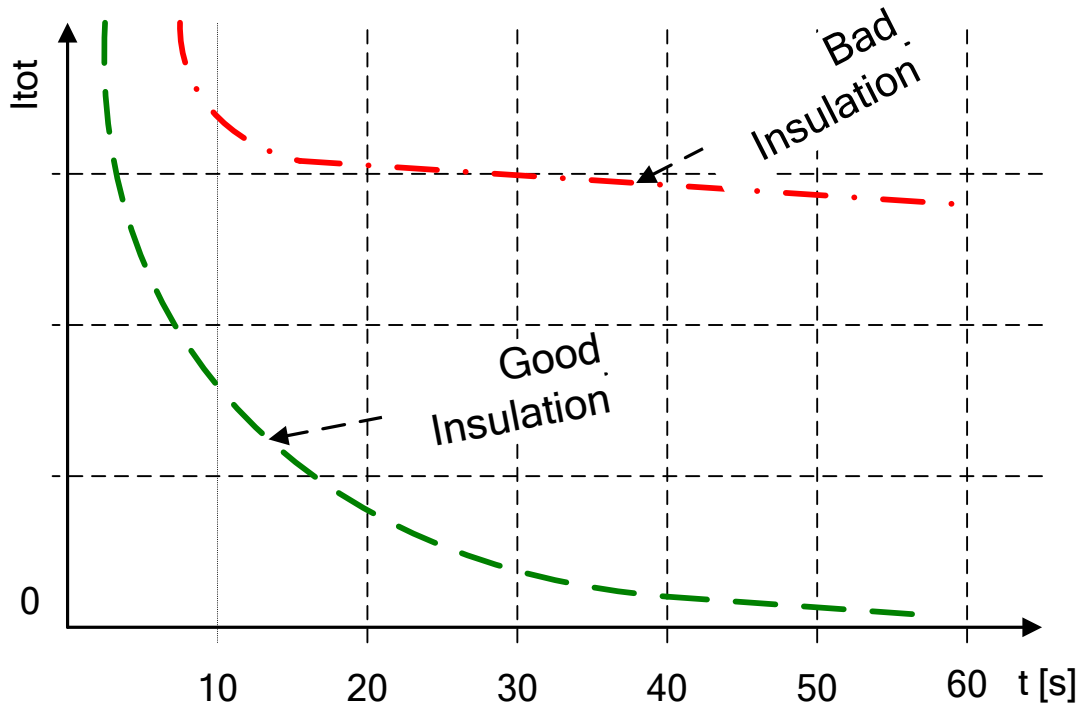

Figure 11.48: The current/time diagram of a good and bad insulation tested with dielectric discharge method

The dielectric discharge test is very useful for testing a multi-layer insulation. This test can identify excess discharge currents that occur when one layer of a multi-layer insulation is damaged or contaminated. This condition will not be detected by both the spot test and the polarization index test. Discharge current will be higher for known voltage and capacitance if an internal layer is damaged. The time constant of this individual layer will differ from other layers, causing a higher current than that of a sound insulation.

11.7.3 Varistor Test

A voltage ramp starts from 50 V and rises with a slope of 80 V/s. The measurement ends when the defined end voltage is reached or if the test current exceeds the set trigger value. Test can be started from the Varistor Test window. Before carrying out a test the following parameters can be edited.

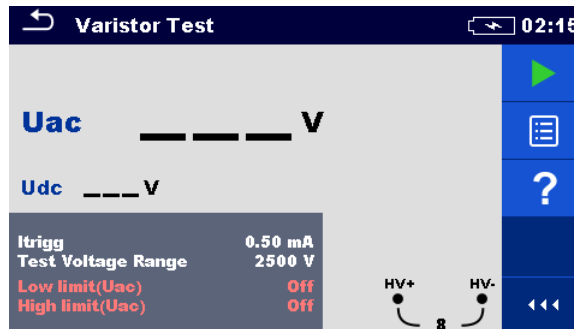

Figure 11.49: Varistor Test menu

Test parameters for Varistor Test:

Itrigg	Set trigger current level: [0.1 mA – 1.5 mA] step 0.1 mA
Test Voltage Range	Set test voltage range or max Udc value: [1000 V, 1500 V, 2500 V]
Low limit (Uac)	Low Limit Uac value selection: [OFF, 50 V – 620 V @Udc = 1000 V, 50 V – 930 V @Udc = 1500 V, 50 V – 1550 V @Udc = 2500 V]
High limit (Uac)	High Limit Uac value selection: [OFF, 50 V – 620 V @Udc = 1000 V, 50 V – 930 V @Udc = 1500 V, 50 V – 1550 V @Udc = 2500 V]

Varistor Test procedure:

- Select the Varistor Test function.
- Set the test parameters (Itrigg, test voltage range and limits).
- Connect the test leads to the instrument and to the test object.
- Press the Run key to start the measurement.
- Wait until the test result is displayed on the screen.
- Wait for the object under test to discharge.
- Save results (optional).

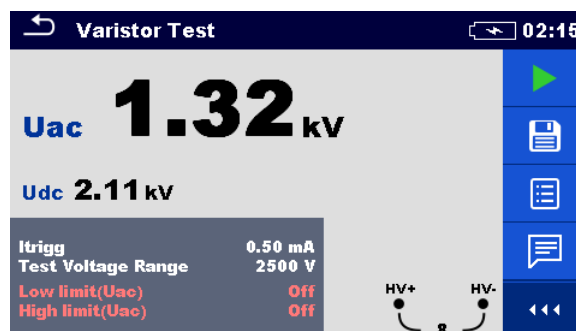

Figure 11.50: Example of Varistor Test result

Notes:

- Consider displayed warnings when starting the measurement!
- A high-voltage warning symbol appears on the display during the measurement to warn the operator of a potentially dangerous test voltage.

Meaning of the Uac voltage

Protection devices intended for a.c. network are usually dimensioned approx. 15 % above peak value of the nominal mains voltage. The relation between Udc and Uac is following:

$$Uac \approx Udc / (1.15 \times \sqrt{2})$$

Uac voltage may be directly compared with the voltage declared on tested protection device.

11.8 Current [I]

Current	Measurement	Test Mode	Nominal frequency	Filter	Type	Max. Measuring range
I	Current Clamp Meter	cont.	16 Hz – 420 Hz	RMS	A1227	3000 A
					A1281	1000 A
					A1609	3000 A

Table 11.10: Available Current measurements in the MI 3288

A1281 AC current clamp

The A 1281 multi range current clamps are designed for measuring alternating currents on low and medium power installations: (50 mA ... 1000 A). Clamps have four current ranges 0.5 A, 5 A, 100 A and 1000 A, which are selected directly on master instrument. Embedded electronic module is powered directly from the connected instrument and does not need any additional power supply.

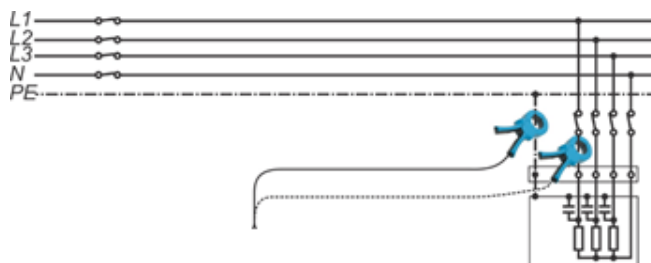
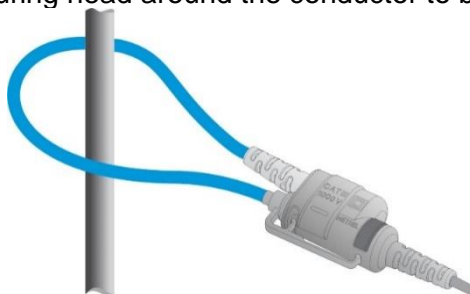

Figure 11.51: A1281 Clamp example

A1227 and A1609 Flex current clamp

1. Wrap the flexible measuring head around the conductor to be tested and close coupling.



- It is very important that the conductor is in the centre and perpendicular to the current sensor as much as possible, in order to minimise position measurement error.
 - Minimise influence of adjacent current-carrying conductors, and measure at the point where they are far away from each other.
 - Make sure that the arrow marked on the clamp coupling points toward the correct orientation for correct phase.
 - Keep the clamps coupling more than 2.5 cm (1 in) away from conductor.
2. Connect Flexible Current Clamps to the clamp input on the instrument.
 3. Select appropriate Current clamp range.
 4. Start measurement.
 5. Observe the current value on the master instrument's display. If desired, select the lower clamp range for better accuracy.

11.8.1 Current Clamp Meter

Measurement can be started from the Current Clamp Meter window. Before carrying out a measurement the following parameters (Clamp Type and Clamp Range) can be edited.

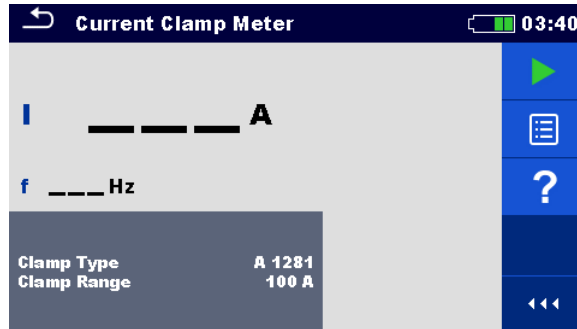

Figure 11.52: Current Clamp Meter menu

Test parameters for Current Clamp Meter:

Clamp Type Set clamp type: [A1227, A1281, A1609]

Clamp Range Set clamp range: [30 A, 300 A, 3000 A] @ (A1227 and A1609),
[0.5 A, 5 A, 100 A, 1000 A] @ A1281

Current Clamp Meter procedure:

- Select the Current Clamp Meter function.
- Set the test parameter (clamp type and clamp range).
- Connect the clamp to the instrument and to the test object.
- Press the Run key to start the measurement.
- Wait until the test result is displayed on the screen.
- Press the Run key again to stop the measurement.
- Save results (optional).

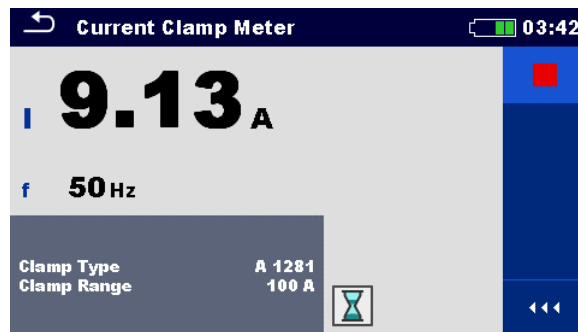

Figure 11.53: Example of Current Clamp Meter result

Note:

- Consider displayed warnings when starting the measurement!

12 Auto Sequences®

Pre-programmed sequences of measurements can be carried out in Auto Sequence® menu. The sequence of measurements, their parameters and flow of the sequence can be programmed. The results of an Auto Sequence® can be stored in the memory together with all related information.

Auto Sequence® can be pre-programmed on PC with the Metrel ES Manager software and uploaded to the instrument. On the instrument parameters and limits of individual single test in the Auto Sequence can be changed / set.

12.1 Selection of Auto Sequence®

The Auto Sequence® list from Auto Sequence® groups menu should be selected first. Refer to chapter **8.8 Auto Sequence® groups** for more details.

12.1.1 Selecting an active Auto Sequence® group in Auto Sequences® menu

Auto Sequences® and Auto Sequence® group menus are interconnected so an active Auto Sequence® group can be selected also in the Auto Sequences® menu.

Procedure

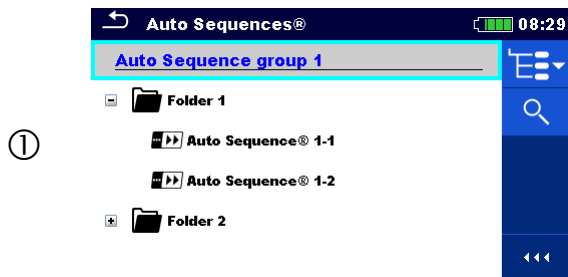

Tap on the active Auto Sequence® group header in Auto Sequences® Menu.



Opens a list of Auto Sequence® groups in Control panel.

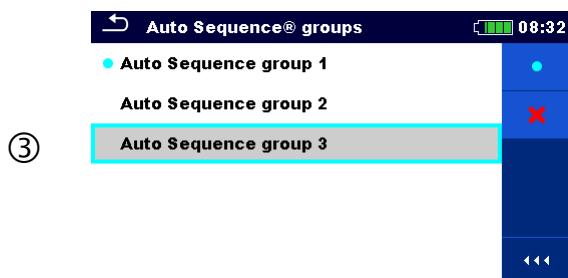

Selects desired Auto Sequence® group from a list of groups.



Confirms a new selection.

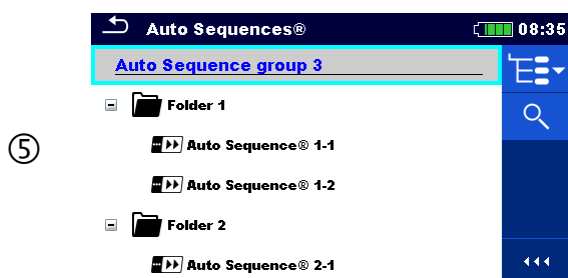

New Auto Sequence® group is selected and all Auto Sequences® within that group are displayed on the screen.

12.1.2 Searching in Auto Sequences® menu

In Auto Sequence® menu it is possible to search for Auto Sequences® on base of their Name or Short code.

Procedure

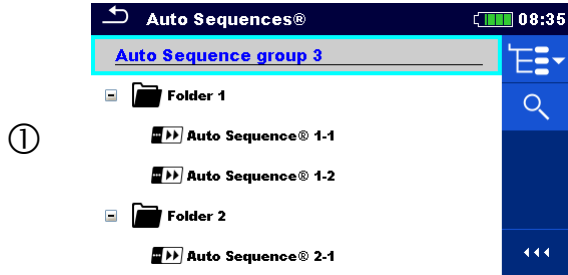

Search function is available from the active Auto Sequence® group header line.



Select Search in control panel to open Search setup menu.

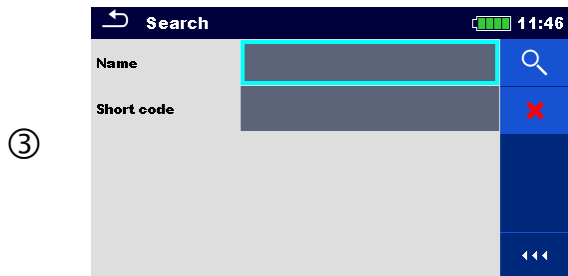

The parameters that can be searched for are displayed in the Search setup menu.

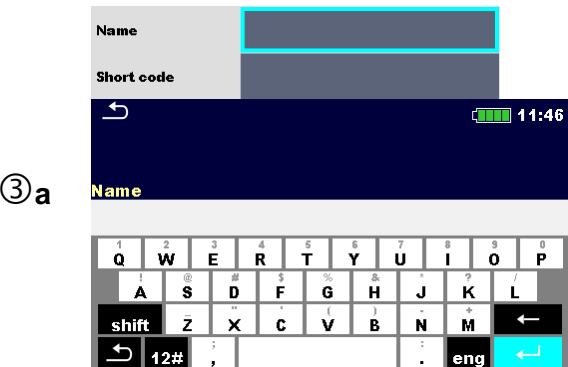

The parameters that can be searched for are displayed in the Search setup menu. The search can be narrowed by entering a text in the Name and Short code fields. Strings can be entered by using the on-screen keyboard.



Clears all filters. Sets filters to default value.



Searches through the active Auto Sequence® group according to the set filters. The results are shown in the Search results screen presented on *Figure 12.1: Search results screen (left), Auto Sequence selected (right)*.



Figure 12.1: Search results screen (left), Auto Sequence selected (right)

Options



Next page.



Previous page.



Goes to location in Auto Sequences® menu.



Goes to Auto Sequence® view menu.



Starts the selected Auto Sequence®.

Note:

- Search result page consist of up to 50 results.

12.1.3 Organization of Auto Sequences® in Auto Sequences® menu

The Auto Sequence® to be carried out can be selected from the Main Auto Sequences® menu. This menu can be organized in structural manner with folders, sub-folders and Auto Sequences®. Auto Sequence® in the structure can be the original Auto Sequence® or a shortcut to the original Auto Sequence®.

Auto Sequences® marked as shortcuts and the original auto Sequences® are coupled. Changing of parameters or limits in any of the coupled Auto Sequences® will influence on the original Auto Sequence® and all its shortcuts.

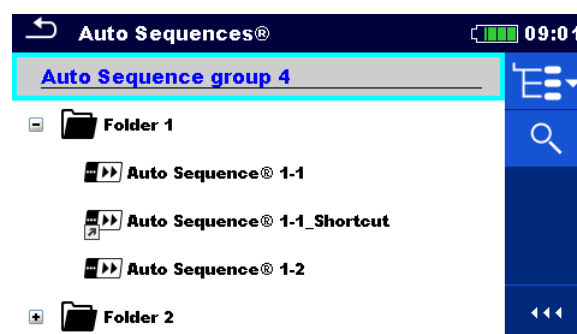

Figure 12.2: Example of organized Auto Sequences® in main Auto Sequences® menu

Options

The original Auto Sequence®.



A shortcut to the original Auto Sequence®.



Enters menu for more detail view of selected Auto Sequence®. This option should also be used if the parameters / limits of the selected Auto Sequence® have to be changed. Refer to chapter **12.2.1 Auto Sequence® view menu** for more information.



Starts the selected Auto Sequence®. The instrument immediately starts the Auto Sequence®.



Searches within the Auto Sequences® menu. Refer to chapter **12.1.2 Searching in Auto Sequences® menu** for more information.

12.2 Organization of Auto Sequence®

An Auto Sequence® is divided into three phases:

- ❑ Before starting the first test, the Auto Sequence® view menu is shown (unless it was started directly from the Main Auto Sequence® menu). Parameters and limits of individual measurements can be set in this menu.
- ❑ During the execution phase of an Auto Sequence®, pre-programmed single tests are carried out. The sequence of single tests is controlled by pre-programmed flow commands.
- ❑ After the test sequence is finished, the Auto Sequence® result menu is shown. Details of individual tests can be viewed and the results can be saved to Memory organizer.

12.2.1 Auto Sequence® view menu

In the Auto Sequence® view menu, the header and the single tests of selected Auto Sequence® are displayed. The header contains the name and description of the Auto Sequence®. Before starting the Auto Sequence®, test parameters / limits of individual measurements can be changed.

Auto Sequence® view menu (header is selected)

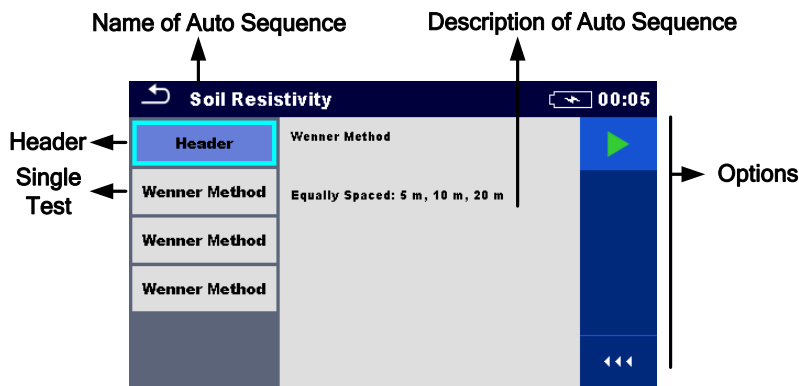

Figure 12.3: Auto Sequence® view menu – header selected

Options



Starts the Auto Sequence®.

Auto Sequence® view menu (measurement is selected)

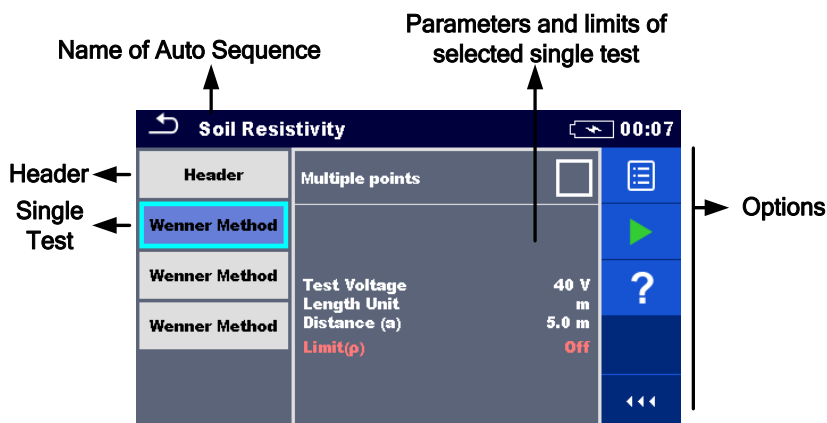

Figure 12.4: Auto Sequence® view menu – measurement selected

Options



Selects single test.



Opens menu for changing parameters and limits of selected measurements. Refer to chapter **10.1.2 Setting parameters and limits of single tests** for more information how to change measurement parameters and limits.



Starts the Auto Sequence®.

Indication of Loops



The attached 'x2' at the end of single test name indicates that a loop of single tests is programmed. This means that the marked single test will be carried out as many times as the number behind the 'x' indicates. It is possible to exit the loop before, at the end of each individual measurement.

12.2.2 Step by step executions of Auto Sequence®

While the Auto Sequence® is running, it is controlled by pre-programmed flow commands. Examples of actions controlled by flow commands are:

- ❑ pauses during the test sequence
- ❑ buzzer
- ❑ proceeding of test sequence in regard to measured results

The actual list of flow commands is available in **Appendix D.5 Description of flow commands**.

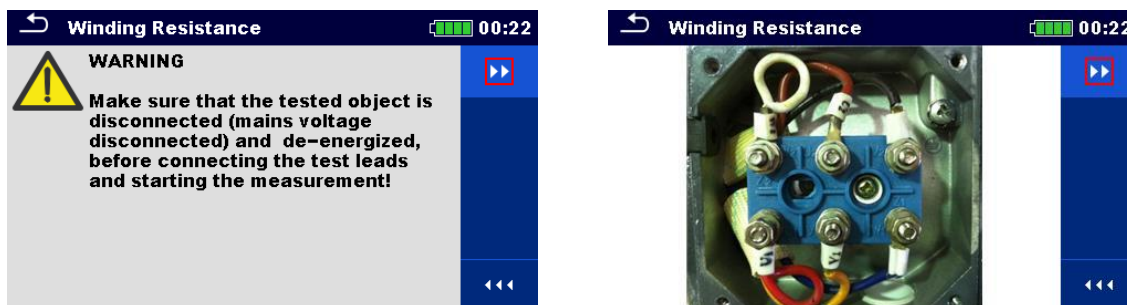

Figure 12.5: Auto Sequence® – example of a pause with message (text or picture)

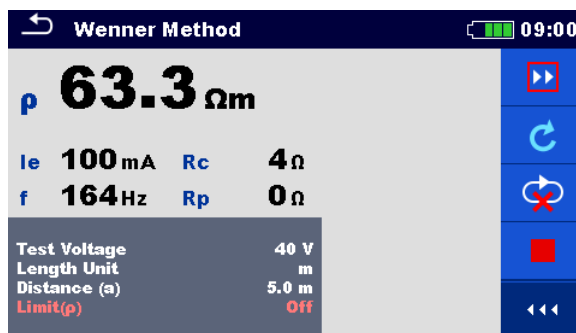

Figure 12.6: Auto Sequence® – example of a finished measurement with options for proceeding

Options (during execution of an Auto Sequence®)



Proceeds to next step in the test sequence.



Repeats the measurement.
Displayed result of a single test will not be stored.



Ends the Auto Sequence® and goes to Auto Sequence® result screen.



Exits the loop of single tests and proceeds to the next step in the test sequence.



on

View parameters and limits of a measurement.



Adds comment.
The instrument opens keypad for entering a comment to a current measurement.

Note:

- The offered options in the control panel depend on the selected single test, its result and the programmed test flow.

12.2.3 Auto Sequence® result screen

After the Auto Sequence® is finished the Auto Sequence® result screen is displayed. At the left side of the display, the single tests and their statuses in the Auto Sequence® are shown. In the middle of the display the header of the Auto Sequence® is displayed. At the top, the overall Auto Sequence® status is displayed. Refer to chapter **9.1.1 Measurement statuses** for more information.

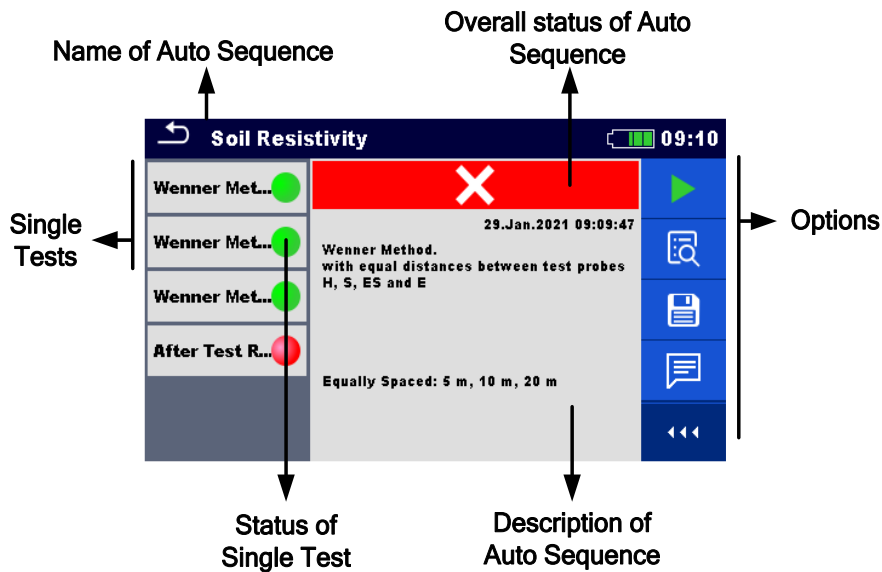

Figure 12.7: Auto Sequence® result screen

Options



Start Test
Starts a new Auto Sequence®.



View results of individual measurements.
The instrument goes to menu for viewing details of the Auto Sequence®.



Saves the Auto Sequence® results.
A new Auto Sequence® was selected and started from a Structure object in the structure tree:

- The Auto Sequence® will be saved under the selected Structure object.

A new Auto Sequence® was started from the Auto Sequence® main menu:

- Saving under the last selected Structure object will be offered by default. The user can select another Structure object or create a new Structure object. By pressing  in Memory organizer menu the Auto Sequence® is saved under selected location.

An empty measurement was selected in structure tree and started:

- The result(s) will be added to the Auto Sequence®. The Auto Sequence® will change its overall status from 'empty' to 'finished'.

An already carried out Auto Sequence® was selected in structure tree, viewed and then restarted:

- A new Auto Sequence® will be saved under the selected Structure object.



Adds comment.
The instrument opens keypad for entering a comment to Auto Sequence result.

Options in menu for viewing details of Auto Sequence® results



Details of selected single test in Auto Sequence® are displayed.



Opens menu for viewing parameters and limits of selected measurements. Refer to chapter **10.1.2 Setting parameters and limits of single tests** for more information.



Adds comment to selected single test result. View / edit comment to selected single test result, when recalled from memory.

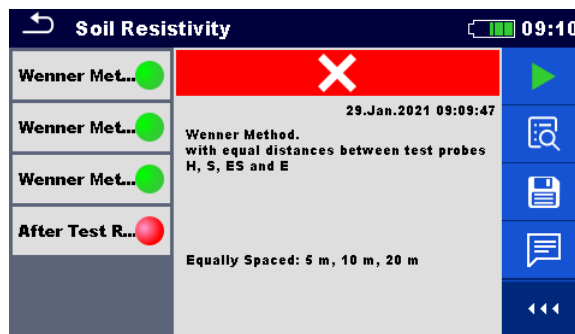

Figure 12.8: Details of menu for viewing details of Auto Sequence® results

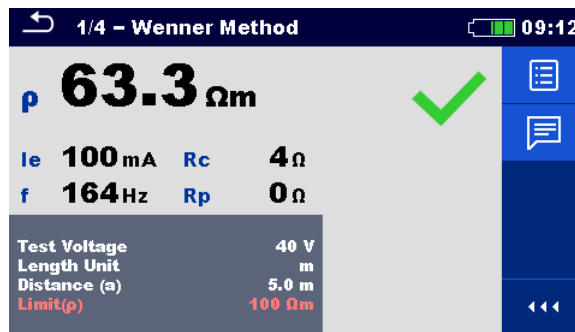

Figure 12.9: Details of single test in Auto Sequence® result menu

12.2.4 Auto sequence memory screen

In Auto Sequence® memory screen details of the saved Auto Sequence® can be viewed and a new Auto Sequence® can be restarted.

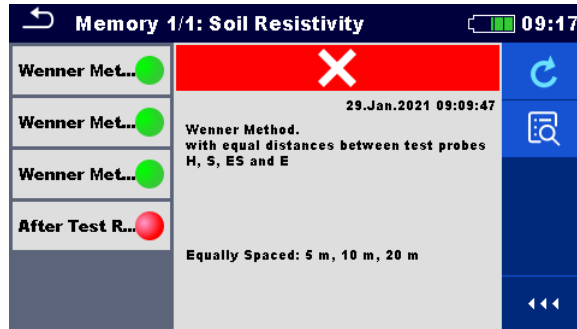

Figure 12.10: Auto Sequence® memory screen

Options



Retest the Auto Sequence®.
Enters menu for a new Auto Sequence®.



Enters menu for viewing details of the saved Auto Sequence®.

13 Communication

The instrument can communicate with the Metrel ES Manager PC software. The following action is supported:

- ❑ Saved results and Tree structure from Memory organizer can be downloaded and stored to a PC.
- ❑ Tree structure and Auto Sequences® from Metrel ES Manager PC software can be uploaded to the instrument.

Metrel ES Manager is PC software running on Windows 8, Windows 8.1 and Windows 10. There are three communication interfaces available on the instrument: RS-232, USB and Bluetooth.

The instrument automatically selects the communication mode according to detected interface. USB interface has priority.

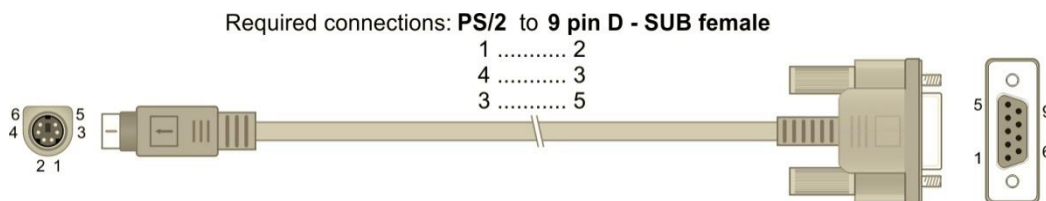

Figure 13.1: Interface connection for data transfer over PC COM port

How to establish an USB or RS-232 link:

- ❑ RS-232 communication: connect a PC COM port to the instrument PS/2 connector using the PS/2 - RS232 serial communication cable;
- ❑ USB communication: connect a PC USB port to the instrument USB connector using the USB interface cable.
- ❑ Switch on the PC and the instrument.
- ❑ Run the Metrel ES Manager software.
- ❑ Select communication port (COM port for USB communication is identified as 'Measurement Instrument USB VCom Port'.
- ❑ The instrument is prepared to communicate with the PC over USB.

Bluetooth communication

The internal Bluetooth module enables easy communication via Bluetooth with PC and Android devices.

How to configure a Bluetooth link between instrument and PC:

- ❑ Switch On the instrument.
- ❑ On PC configure a Standard Serial Port to enable communication over Bluetooth link between instrument and PC. Usually, no code for pairing the devices is needed.
- ❑ Run the Metrel ES Manager software.
- ❑ Set the configured communication port.
- ❑ The instrument is prepared to communicate with the PC over Bluetooth.

Notes:

- ❑ The name of correctly configured Bluetooth device must consist of the instrument type plus serial number, eg. MI 3288-12345678I.
- ❑ Bluetooth communication device pairing code is 1234.

14 Maintenance

Unauthorized persons are not allowed to open the MI 3288 instrument. There are no user replaceable components inside the instrument, except the battery and fuse under back cover.

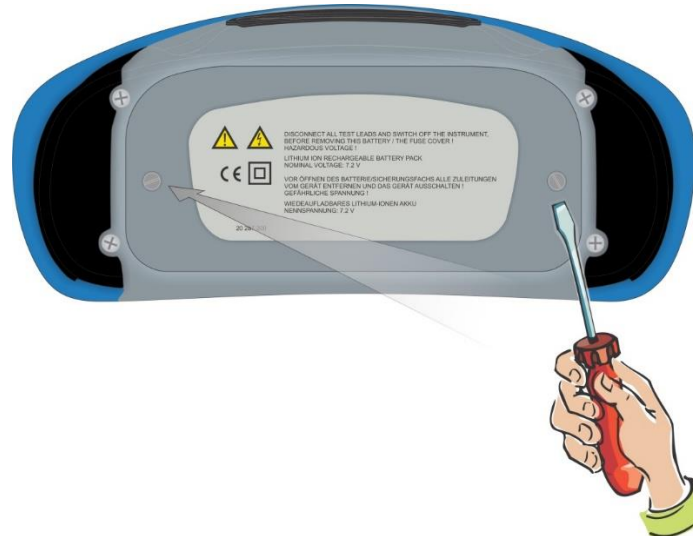

Figure 14.1: Position of screws to open battery / fuse compartment

14.1 Fuse replacement

There is a fuse under back cover of the MI 3288 instrument.

F2 FF 2 A / 1000 V, 32×6.3 mm (breaking capacity: 50 kA)
H, C1 terminal protection fuse

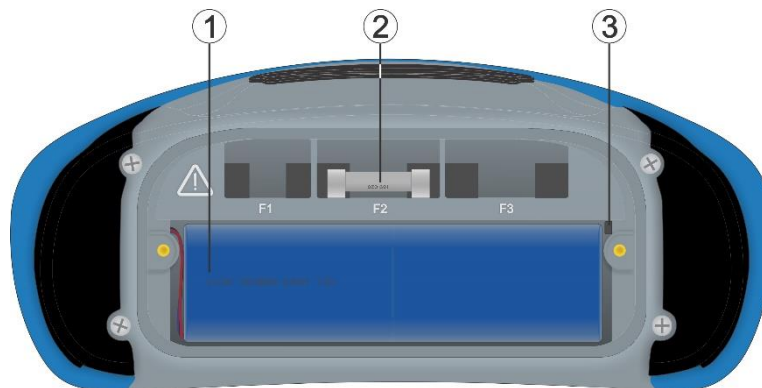

Figure 14.2: Fuses



Warnings:

- ❑ Disconnect all measuring accessory and switch off the instrument before opening battery / fuse compartment cover, hazardous voltage inside!
- ❑ Replace blown fuse with original type only, otherwise the instrument or accessory may be damaged and / or operator's safety impaired!

14.2 Battery pack insertion / replacement

Procedure:

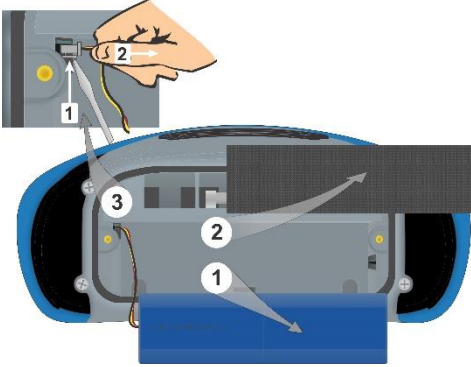
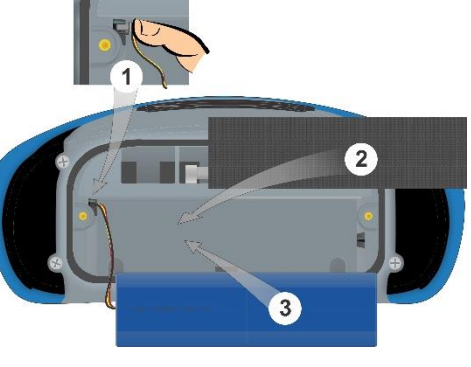
①	Remove the battery pack from battery compartment.	
②	Remove foam if were inserted under the battery pack.	
③	Press to unlock the connector (1) and pull the wires (2) to disconnect the battery pack from the instrument.	
①	Connect the new battery pack to the instrument.	
②	For standard capacity pack use a foam (2) to fill empty space.	
③	Insert the battery pack in battery compartment and close the battery / fuse compartment cover. Note: When placing high-capacity battery pack make sure that protection circuit module of the battery pack is placed at top inner side of the compartment.	



Warnings:

- ❑ Disconnect all measuring accessory and switch off the instrument before opening battery / fuse compartment cover, hazardous voltage inside!
- ❑ Replace battery pack with original type only, otherwise the instrument may be damaged and / or operator's safety impaired!
- ❑ Ensure batteries are used and disposed of in accordance with Manufacturers guidelines and in accordance with Local and National Authority guidelines.

14.3 Cleaning

No special maintenance is required for the housing. To clean the surface of the instrument, use a soft cloth slightly moistened with soapy water or alcohol. Then leave the instrument to dry totally before use.



Warnings:

- ❑ Do not use liquids based on petrol or hydrocarbons!
- ❑ Do not spill cleaning liquid over the instrument!

14.4 Periodic calibration

It is essential that the test instrument is regularly calibrated in order that the technical specification listed in this manual is guaranteed. We recommend an annual calibration. Only an authorized technical person can do the calibration. Please contact your dealer for further information.

14.5 Service

For repairs under warranty, or at any other time, please contact your distributor.

14.6 Upgrading the instrument

The instrument can be upgraded from a PC via the USB communication port. This enables to keep the instrument up to date even if the standards or regulations change. The firmware upgrade requires internet access and can be carried out from the **Metrel ES Manager software** with a help of special upgrading software – FlashMe that will guide you through the upgrading procedure. For more information, refer to Metrel ES Manager Help file.

<https://www.metrel.si/en/downloads/>

Note:

- ❑ See chapter **13 Communication** for details on connections.

15 Technical specifications

15.1 Voltage and frequency [U/f]

15.1.1 Voltage Meter RMS

Measurement principle: Voltage measurement (True r.m.s.)

Display range Uac..... 0.000 V ... >750 V

Voltage	Measuring range	Resolution	Uncertainty
Uac	0.000 V ... 9.999 V	0.001 V	Freq. range: 15 Hz ... 99 Hz ±(0.5 % of reading + 3 digits)
	10.00 V ... 99.99 V	0.01 V	Freq. range: 100 Hz ... 399 Hz ±(1 % of reading + 3 digits)
	100.0 V ... 749.9 V	0,1 V	Freq. range: 400 Hz ... 1200 Hz ±(5 % of reading + 3 digits)

Display range Udc 0.000 V ... >1100 V

Voltage	Measuring range	Resolution	Uncertainty
Udc	0.000 V ... 9.999 V	0.001 V	±(0.5 % of reading + 3 digits)
	10.00 V ... 99.99 V	0.01 V	
	100.0 V ... 999.9 V	0.1 V	

Display range U 0.000 V ... >1100 V

Voltage	Measuring range	Resolution	Uncertainty
U	0.000 V ... 9.999 V	0.001 V	calculated value (consider uncertainty of Uac and Udc)
	10.00 V ... 99.99 V	0.01 V	
	100.0 V ... 999.9 V	0.1 V	

Displayed voltage result U (ac + dc) is calculated as follows:

$$U = \sqrt{(Uac)^2 + (Udc)^2}$$

Test mode continuous

Result type AC, DC or AC + DC

Nominal frequency range DC, 15.00 Hz to 1.200 kHz

Input resistance (HV+) – (HV-) 25 MΩ ± 5 %

Measuring refresh rate typical 1 s

Automatic range selection yes

15.1.2 Frequency

Measurement principle: Zero-crossing detector measurement

Display range f <12 Hz ... >2000 Hz

Frequency	Measuring range	Resolution	Uncertainty
f	15.00 Hz ... 99.99 Hz	0.01 Hz	±(0.2 % of reading + 1 digits)
	100.0 Hz ... 999.9 Hz	0.1 Hz	
	1.000 kHz ... 1.200 kHz	1 Hz	

Test mode continuous

Nominal voltage range 5 V ... 750 V (AC)

15.2 Current [I]

15.2.1 Iron (A 1281) and Flex (A 1227, A 1609) current clamp

Measurement principle: Current measurement (RMS)

Current	Type	Range	Measuring range	Display range	Resolution	Overall Uncertainty (* See notes)
I	A 1281	0.5 A	10 mA ... 749 mA	0 mA ... 749 mA	1 mA	±(2.5 % of reading + 3 digits)
		5 A	0.10 A ... 7.49 A	0.00 A ... 7.49 A	0.01 A	
		100 A	2 A ... 149 A	0.0 A ... 99.9 A	0.1 A	
				100 A ... 149 A	1 A	
		1000 A	20 A ... 999 A	0 A ... 999 A	1 A	
	A 1227 A 1609	30 A	0.6 A ... 59.9 A	0.0 A ... 59.9 A	0.1 A	±(3.5 % of reading + 3 digits)
		300 A	6 A ... 599 A	0 A ... 599 A	1 A	
		3000 A	0.06 kA ... 5.99 kA	0.00 kA ... 5.99 kA	0.01 kA	

Input terminal galvanic separated (clamp connector)

Test mode continuous

Measuring frequency range 16 Hz ... 420 Hz

Input impedance 100 kΩ (clamp connector)

Instrument accuracy (clamp connector) 2 %

Measuring refresh rate 3 s typical

*Notes:

- Minor exceeding the clamp range will cause the instrument to display > and the appropriate range (e.g. >599 A).
- Large exceeding of the clamp range or wrong clamps selected will cause the horizontal dashes (- - -) to be displayed.
- Frequency is only displayed if ($I_m \geq 1 \% I_{clamp_range}$), where I_m presents measured current and I_{clamp_range} set value of clamp range. Otherwise the horizontal dashes (- - -) are displayed.
- Overall uncertainty (as percent of measured value), is provided as guideline. For exact measuring range and uncertainty, please check user manual of related current clamps. Overall uncertainty is calculated as:

$$OverallAccuracy = 1.15 \cdot \sqrt{InstrumentAccuracy^2 + ClampAccuracy^2}$$

15.3 Earth [Ze]

15.3.1 2, 3, 4 - pole

Measurement principle Voltage / Current measurement

Display range Ze (0.000 Ω ... >19.99 kΩ)

Earth	Test frequency	Measuring range	Resolution	Uncertainty (* See notes)
Ze	55 Hz ... 164 Hz	0.010 Ω ... 1.999 Ω	0.001 Ω	±(3 % of reading + 3 digits)
		2.00 Ω ... 19.99 Ω	0.01 Ω	
		20.0 Ω ... 199.9 Ω	0.1 Ω	
		200 Ω ... 999 Ω	1 Ω	
		1.000 kΩ ... 1.999 kΩ	0.001 kΩ	
		2.00 kΩ ... 19.99 kΩ	0.01 kΩ	

Test mode single

Open-terminal test voltage 20 or 40 Vac

Test frequency 55 Hz, 82 Hz, 94 Hz, 105 Hz, 111 Hz, 128 Hz, 164 Hz

Short-circuit test current > 80 mA @ 164 Hz, 40 Vac

Limit range (Ze) OFF, 0.1 Ω ... 5.00 kΩ, Custom value

Test voltage shape sine wave

Ze definition Impedance value Z(f).

Re definition Impedance, excluding reactance X(f).

Measuring time see Table 15.1

Typical battery operation time see Table 15.3

Automatic test of probe resistance yes (3, 4 - pole)

Automatic connection test yes [H, S, ES, E]

Automatic range selection yes

Automatic test of voltage noise yes

*** Notes:**

- *Uncertainty depends on the correct compensation of the test leads for 2, 3 – pole, and resistance of probes and auxiliary earth electrodes (see 15.8 Influence of the auxiliary electrodes). Excluding reactance X(f) for the Re result is limited by the accuracy of the phase angle measurement.*

Typical Measuring time	Measurement				
	2 – pole	3 – pole	4 – pole	Selective (Iron Clamp)	2 Clamps (continuous)
55 Hz	5 s	7 s	12 s	14 s	/
82 Hz	3 s	5 s	7 s	9 s	3 s
105 Hz	2 s	3 s	7 s	9 s	3 s
164 Hz	2 s	3 s	7 s	9 s	3 s

Table 15.1: Typical measuring times for different measurements

15.3.2 Selective (Iron Clamp)

Measurement principle: Voltage / Current (external Iron Clamp) measurement
 Display range Zsel (0.000 Ω ... >19.99 kΩ)

Selective Earth Impedance	Test frequency	Measuring range	Resolution	Uncertainty (* See notes)
Zsel	55 Hz ... 164 Hz	0.010 Ω ... 1.999 Ω	0.001 Ω	±(8 % of reading + 3 digits)
		2.00 Ω ... 19.99 Ω	0.01 Ω	
		20.0 Ω ... 199.9 Ω	0.1 Ω	
		200 Ω ... 999 Ω	1 Ω	
		1.000 kΩ ... 1.999 kΩ	0.001 kΩ	
		2.00 kΩ ... 19.99 kΩ	0.01 kΩ	

- Test mode single
- Open-terminal test voltage 40 Vac
- Test frequency 55 Hz, 82 Hz, 94 Hz, 105 Hz, 111 Hz, 128 Hz, 164 Hz
- Short-circuit test current > 80 mA @ 164 Hz, 40 Vac
- Limit range (Zsel) OFF, 0.1 Ω ... 5 kΩ, Custom value
- Test voltage shape sine wave
- Zsel definition Impedance value Z(f).
- Measuring time see Table 15.1
- Typical battery operation time see Table 15.3
- Measurement Clamp type A1281
- Automatic test of probe resistance yes
- Automatic connection test yes [H, S, ES, E]
- Automatic range selection yes
- Automatic test of voltage noise yes
- Low clamp current indication yes [Ic]

* Notes:

- Uncertainty depends on the correct compensation of the test leads for 2, 3 – pole, and resistance of probes and auxiliary earth electrodes (See 15.8 Influence of the auxiliary electrodes.)

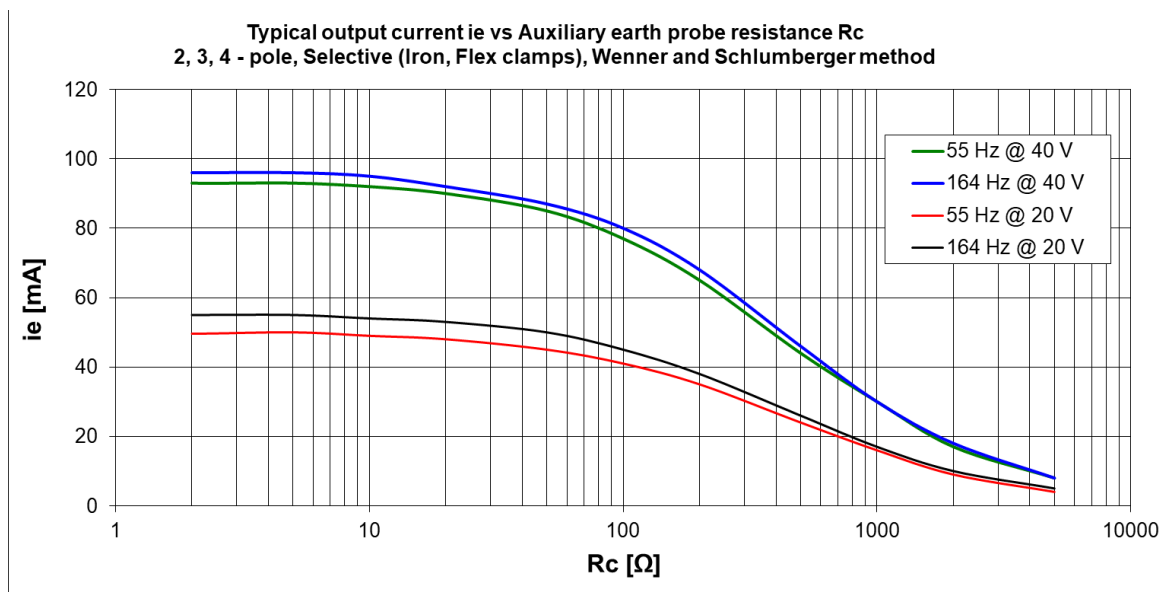

15.3.3 2 Clamps

Measurement principle: Measurement of resistance in closed loops using two iron current clamps

Display range Ze (0.000 Ω ... >100 Ω)

Loop Impedance	Measuring range	Resolution	Uncertainty
Ze	0.000 Ω ... 1.999 Ω	0.001 Ω	±(5 % of reading + 5 digits)
	2.00 Ω ... 9.99 Ω	0.01 Ω	±(5 % of reading + 2 digits)
	10.0 Ω ... 49.9 Ω	0.1 Ω	±(10 % of reading + 2 digits)
	50 Ω ... 100 Ω	1 Ω	±(20 % of reading)

- Test mode continuous
- Min. distance between test clamps > 30 cm
- Test frequency 82 Hz, 94 Hz, 105 Hz, 111 Hz, 128 Hz, 164 Hz
- Limit range (Ze) OFF, 0.1 Ω ... 40 Ω, Custom value
- Test voltage shape sine wave
- Ze definition Impedance value Z(f).
- Measuring refresh rate typical 2.5 s at 164 Hz (depending on test frequency)
- Typical battery operation time see Table 15.3
- Measurement Clamp type A1281
- Generator Clamp type A1019
- Automatic range selection yes
- Automatic test of voltage noise yes
- Low clamp current indication yes [Ic]

Typical loop (test) current	Loop Impedances				
	100 mΩ	500 mΩ	1 Ω	5 Ω	10 Ω
164 Hz	130 mA	32 mA	16 mA	3.5 mA	1.7 mA

Table 15.2: Typical loop (test) current for different loop impedances

15.4 Specific Earth Resistance Measurements [ρ]

15.4.1 Wenner and Schlumberger method

Measurement principle Voltage / Current measurement

Specific Earth	Measuring range	Resolution	Uncertainty
ρ	0.00 Ω m ... 19.99 Ω m	0.01 Ω m	calculated value (consider uncertainty of 4 – pole measurement)
	20.0 Ω m ... 199.9 Ω m	0.1 Ω m	
	200 Ω m ... 999 Ω m	1 Ω m	
	1.000 k Ω m ... 1.999 k Ω m	0.001 k Ω m	
	2.00 k Ω m ... 19.99 k Ω m	0.01 k Ω m	
	20.0 k Ω m ... 199.9 k Ω m	0.1 k Ω m	
	200 k Ω m ... 999 k Ω m	1 k Ω m	
	1.00 M Ω m ... 1.99 M Ω m	10 k Ω m	

Specific Earth	Measuring range	Resolution	Uncertainty
ρ	0.00 Ω ft ... 19.99 Ω ft	0.01 Ω ft	calculated value (consider uncertainty of 4 – pole measurement)
	20.0 Ω ft ... 199.9 Ω ft	0.1 Ω ft	
	200 Ω ft ... 999 Ω ft	1 Ω ft	
	1.000 k Ω ft ... 1.999 k Ω ft	0.001 k Ω ft	
	2.00 k Ω ft ... 19.99 k Ω ft	0.01 k Ω ft	
	20.0 k Ω ft ... 199.9 k Ω ft	0.1 k Ω ft	
	200 k Ω ft ... 999 k Ω ft	1 k Ω ft	
	1.00 M Ω ft ... 1.99 M Ω ft	10 k Ω ft	

Test mode single
 Open-terminal test voltage..... 40 Vac
 Test frequency 164 Hz
 Short-circuit test current > 80 mA @ 164 Hz, 40 Vac
 Limit range (ρ) OFF, 0.1 Ω m ... 900 k Ω m
 Limit range (ρ) OFF, 0.1 Ω ft ... 900 k Ω ft
 Test voltage shape sine wave
 Measuring time..... see Table 15.1
 Typical battery operation time see Table 15.3
 Automatic test of probe resistance yes
 Automatic connection test yes [H, S, ES, E]
 Automatic range selection yes
 Automatic test of voltage noise..... yes

15.5 Earth Potential [Us]

15.5.1 Step and Touch

Measurement principle: Current /Voltage measurement

Step and Touch	Measuring range	Resolution	Uncertainty
Us	0.1 V ... 199.9 V	0.1 V	calculated value (consider uncertainty of Um measurement)
	200 V ... 999 V	1 V	

Voltage	Measuring range	Resolution	Uncertainty
Um	0.00 mV ... 99.99 mV	0.01 mV	±(1 % of reading + 3 digits)
	100.0 mV ... 999.9 mV	0.1 mV	
	1.000 V ... 9.999 V	1 mV	
	10.00 V ... 49.99 V	10 mV	

- Test mode single
- Open-terminal test voltage..... 40 Vac
- Test frequency 55 Hz, 82 Hz
- Short-circuit test current > 120 mA @ 82 Hz
- Input resistance (S) 3.0 MΩ
- Fault current (If_{flt}) range (selectable)..... 1 A ... 200 kA
- Measuring time..... see Table 15.1 (4 - pole)
- Automatic test of probe resistance yes
- Automatic range selection yes
- Automatic test of voltage noise yes

Displayed Potential voltage (Us) is calculated as follows:

$$U_s = U_m * (I_{fault} / I_{gen})$$

Note:

- A 1597 Human body probe with an internal resistance of 1 kΩ ±1 %, 10 W.

15.6 DC Resistance [R]

15.6.1 Ω - Meter (200mA)

Measurement principle: Voltage (dc) / Current (dc) measurement

Display range R..... 0.000 Ω ... >1.99 kΩ

DC Resistance	Measuring range	Resolution	Uncertainty (* See note)
R	0.020 Ω ... 1.999 Ω	0.001 Ω	±(1 % of reading + 2 digits)
	2.00 Ω ... 19.99 Ω	0.01 Ω	
	20.0 Ω ... 999.9 Ω	0.1 Ω	
	1.000 kΩ ... 1.999 kΩ	1 Ω	

Test mode single

Open-terminal test voltage..... ~5 V_{dc}

Short-circuit test current min. 200 mA_{dc} into load resistance of 2 Ω

Test current direction bidirectional

Max inductivity 2 H

Limit range (R) OFF, 0.1 Ω ... 40 Ω, Custom value

Measuring time..... typical 2 s

Typical battery operation time see Table 15.3

Test method..... 2-wire or 4-wire

Test lead compensation.....yes, up to 5 Ω

Maximum lead resistance1 Ω total (R_{lead} C1 + C2) and 500 Ω total (R_{lead} P1 + P2)

Automatic range selection yes

Automatic test of voltage noise..... yes

* Note:

- Uncertainty depends on the correct compensation of the test leads (2-wire test method).

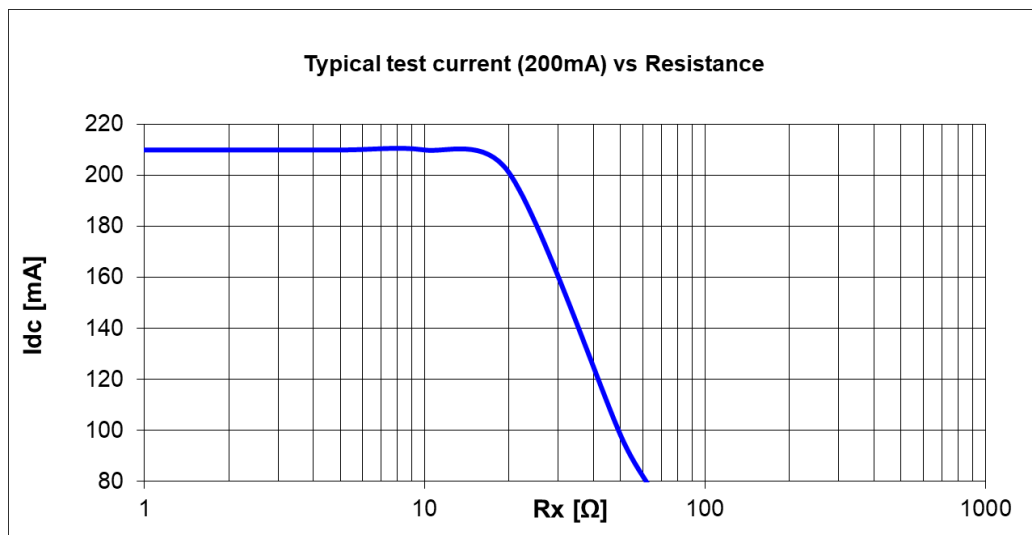

15.6.2 Ω - Meter (7mA)

Measurement principle: Voltage (dc) / Current (dc) measurement

Display range R..... 0.0 Ω ... >999 kΩ

DC Resistance	Measuring range	Resolution	Uncertainty (* See note)
R	0.0 Ω ... 199.9 Ω	0.1 Ω	±(0.5 % of reading + 5 digits)
	200 Ω ... 1999 Ω	1 Ω	
	2.00 kΩ ... 19.99 kΩ	10 Ω	
	20.0 kΩ ... 199.9 kΩ	100 Ω	
	200 kΩ ... 999 kΩ	1 kΩ	±(2 % of reading + 5 digits)

Test mode continuous

Open-terminal test voltage..... ~14 V_{dc}

Short-circuit test current ~6,8 mA_{dc}

Test current direction unidirectional

Limit range (R) OFF, 1 Ω ... 15.0 kΩ, Custom value

Measuring refresh rate <0.5 s

Test method..... 2-wire

Test lead compensation.....yes, up to 5 Ω

Automatic range selection yes

Automatic test of voltage noise..... yes

Typical battery operation time see Table 15.3

* Note:

- Uncertainty depends on the correct compensation of the test leads.
- Continuous sound - I_{dc} measurement current is higher or equal to 5.0 mA.

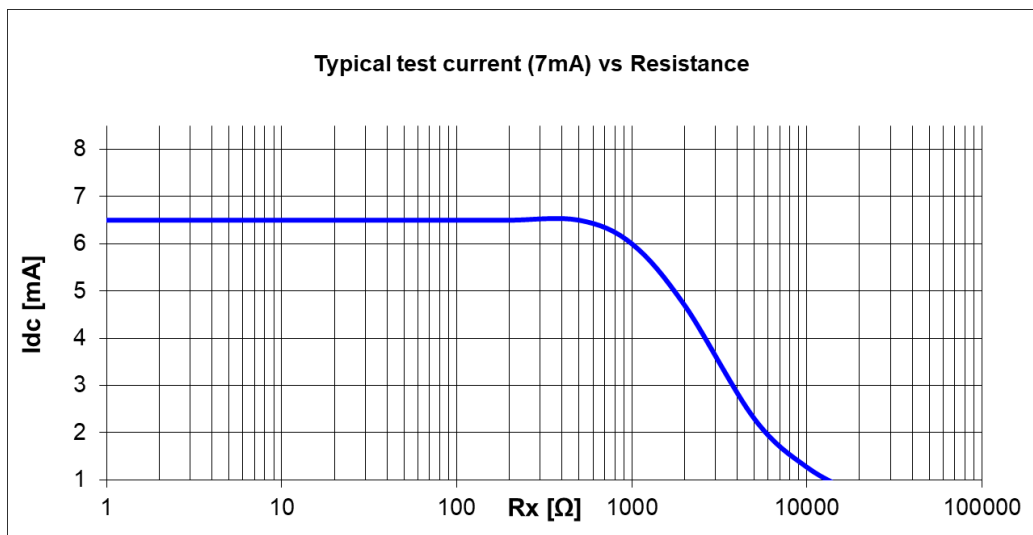

15.7 Insulation Resistance Measurement [Riso]

15.7.1 Insulation Resistance - (IR, DD, - Test)

Measurement principle: Voltage (dc) / Current (dc) measurement

Display range Riso 0 kΩ ... >100 GΩ* (Un and R_{FS} dependent)

Resistance (Measurement ranges and accuracy for Un = 2.5 kV)

DC Resistance	Measuring range	Resolution	Uncertainty (* See notes)
Riso	0 kΩ ... 999 kΩ	1 kΩ	±(3 % of reading + 3 digit)
	1.00 MΩ ... 9.99 MΩ	10 kΩ	
	10.0 MΩ ... 99.9 MΩ	100 kΩ	
	100 MΩ ... 999 MΩ	1 MΩ	
	1.00 GΩ ... 9.99 GΩ	10 MΩ	±(5 % of reading + 3 digits)
	10.0 GΩ ... 99.9 GΩ	100 MΩ	±(15 % of reading + 1 digit)

*Notes:

- Full-scale value of resistance (R_{FS}) depends on nominal test voltage (U_N) and is defined according to the following equation:

$$R_{FS} = 0.04 * 10^9[\Omega/V] * U_N[V]$$

Un – nominal voltage	R _{FS} – full-scale value
50 V	2 GΩ
100 V	4 GΩ
500 V	20 GΩ
1.0 kV	40 GΩ
1.5 kV	60 GΩ
2.0 kV	80 GΩ
2.5 kV	100 GΩ

- Accuracy versus full-scale resistance is defined in table below:

Measuring range (Ω)	Uncertainty
$R < \frac{R_{FS}}{100}$	±(3 % of reading + 3 digit)
$\frac{R_{FS}}{100} \geq R \geq \frac{R_{FS}}{10}$	±(5 % of reading + 3 digits)
$\frac{R_{FS}}{10} \geq R \geq R_{FS}$	±(15 % of reading + 1 digit)

Nominal test voltage ranges 50 V ... 2.5 kV

Voltage step 50 V @ Un (50 V ... 1 kV), 100 V @ Un (1 kV ... 2.5 kV)

Voltage output accuracy ±(10% + 10 V) @ 100 MΩ load

Current capability of test generator > 1 mA for Un set ≥ 350V

Short circuit / charge current > 2 mA

Charging rate for capacitive load < 2 s/μF @ 2.5 kV

Automatic discharge yes

Discharging rate for capacitive load < 0.8 s/μF @ 2.5 kV

Discharging resistance 212 kΩ ± 10 %

Bar graph range 10 kΩ ... 1 GΩ (logarithmic scale)

Guard resistance ~1800 Ω

Additional filtering options OFF, 5 s, 10 s, 30 s, 60 s (Moving Average)

Typical battery operation time see Table 15.3

DC Current

Display range I..... 0.00nA ... 5.0mA

DC Current	Measuring range	Resolution	Uncertainty
I	2.0 mA ... 5.0 mA	0.1 mA	±(1 % of reading + 3 digits)
	0.20 mA ... 1.99 mA	10 µA	
	20 µA ... 199 µA	1 µA	
	2.0 µA ... 19.9 µA	0.1 µA	
	0.20 µA ... 1.99 µA	10 nA	±(5 % of reading + 3 digits)
	20 nA ... 199 nA	1 nA	±(15 % of reading + 1 digits)

DC Voltage

DC Voltage	Measuring range	Resolution	Uncertainty
Um	0 V ... 999 V	1 V	±(1 % of reading + 3 digits)
	1.00 kV ... 2.99 kV	10 V	

Capacitance

Capacitance	Measuring range	Resolution	Uncertainty
C	10 nF ... 999 nF	1 nF	±(5 % of reading + 3 digits)
	1.00 µF ... 9.99 µF	10 nF	
	10.0 µF ... 50.0 µF	100 nF	

Dielectric absorption ratio DAR

DC Voltage	Measuring DAR range	Resolution	Uncertainty (* See note)
DAR	0.01 ... 9.99	0.01	±(5 % of reading + 3 digits)
	10.0 ... 100.0	0.1	

Polarization index PI

DC Voltage	Measuring range	Resolution	Uncertainty (* See note)
PI	0.01 ... 9.99	0.01	±(5 % of reading + 3 digits)
	10.0 ... 100.0	0.1	

Dielectric discharge index DD

DC Voltage	Measuring range	Resolution	Uncertainty (* See note)
DD	0.01 ... 9.99	0.01	±(5 % of reading + 3 digits)
	10.0 ... 100.0	0.1	

***Notes:**

- If additional averaging (AVG) of the result value is turned on PI and DAR will not be calculated (---).
- If enabled, the instrument measures Dielectric Discharge (DD) when the capacitance is within the range of 20 nF to 50 µF.
- Minimal recommended Timer 1 setting is 5 s for IR, DD and SV – test.
- Specified accuracy is valid up to 1 GΩ if relative humidity is > 85 %.
- In case the instrument gets moistened, the results could be impaired. In such case, it is recommended to dry the instrument and accessories for at least 24 hours.

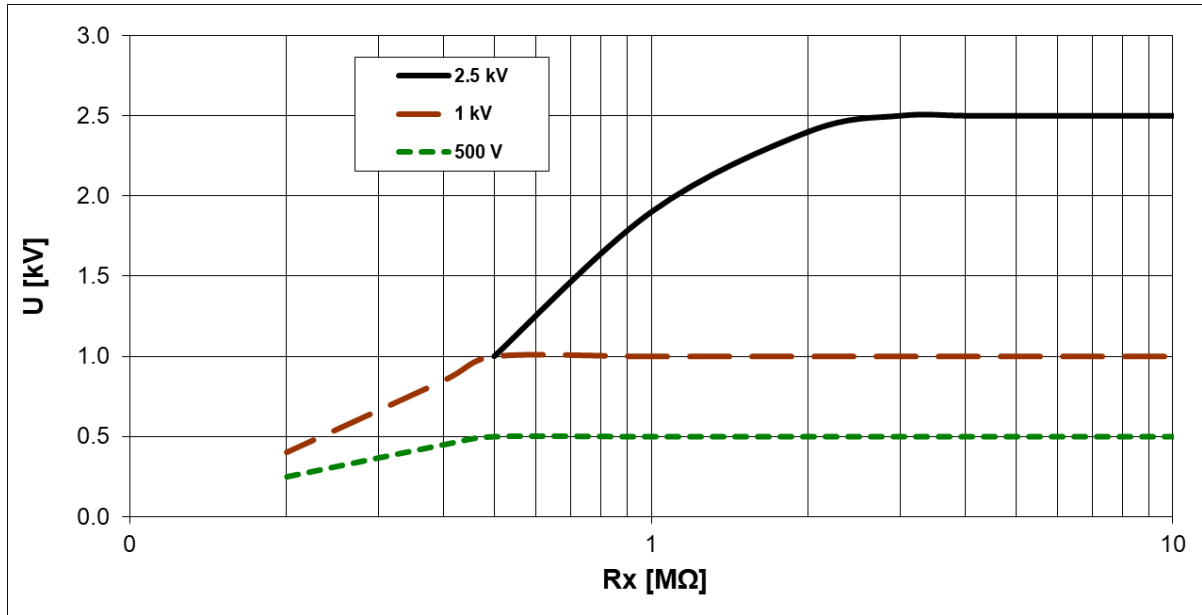

Figure 15.1: Generator capability vs resistance

15.7.2 Varistor test

Measurement principle: Voltage (dc) / Current (dc) measurement; dc voltage ramp.

Display range Uac..... 0.0 V ... >1563 V

Voltage	Measuring range	Resolution	Uncertainty
Uac	0.0 V ... 99.9 V	0.1 V	calculated value (consider uncertainty of DC voltage measurement)
	100 V ... 999 V	1 V	
	1.00 kV ... 1.56 kV	10 V	

Display range Udc 0.0 V ... >2500 V

Voltage	Measuring range	Resolution	Uncertainty
Udc	0.0 V ... 99.9 V	0.1 V	±(1 % of reading + 3 digits)
	100 V ... 999 V	1 V	
	1.00 kV ... 2.50 kV	10 V	

Test method dc voltage ramp

Test voltage range..... 1000 V, 1500 V, 2500 V

Test voltage slope 80 V/s

Threshold current (Itrigg)..... 0.1 mA ... 1.5 mA

Automatic range selection yes

Automatic test of voltage noise..... yes

The relation between Udc and Uac is following:

$$Uac \approx Udc / (1.15 \times \sqrt{2})$$

15.8 Influence of the auxiliary electrodes

Definition of Rc, Rp and Ra:

- Rc Impedance of auxiliary current probes (Rh + Re)
- Rp Impedance of auxiliary potential probes (Rs + Res)
- Ra Earth resistance

Measurement function **3, 4 – pole, Selective (Iron Clamp), Wenner and Schlumberger method,**

Additional uncertainty if limit (Rh, Rs, Res, Re) or max. value are exceeded (whichever is lower).

Test frequency	Limit for Rh and Rs	Limit for Res and Re	max. value	Additional uncertainty
55 Hz ... 164 Hz	> 4 kΩ + 100* Ra	> 4 kΩ + 100* Ra	50 kΩ	±(15 % of reading)

If the auxiliary probes limit is exceeded then the measuring range of the instrument is exceeded.

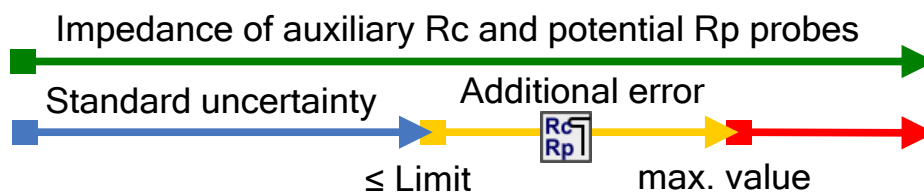

	The measuring range of the instrument is exceeded (- - -)!
--	--

Notes:

- High impedance of auxiliary current or potential probes icon.

	High impedance of auxiliary current and potential probes.
	High impedance of auxiliary current probe Rc.
	High impedance of auxiliary potential probe Rp.

15.9 Influence of low test current through clamps

In large systems the measured partial current is only a small portion of the test current through the current clamp. The measuring uncertainty for small currents and immunity against noise currents must be considered. The tester displays the “low current icon” warning in this case.

	Low test current through Iron Clamps. Results may be impaired. <i>Limit [Iron clamps < 1 mA].</i>
--	--

Measurement function **Selective (Iron Clamp), 2 Clamps,**

Clamps	Additional uncertainty if low current limit is exceeded		
	Index	Limit	Additional uncertainty
Iron clamp (A1281)	Ic	< 1 mA	±(10 % of reading + 2 digits)

15.10 Influence of noise

Definition of noise:

Injection of series interference (voltage / current) with system frequencies of: 16 2/3 Hz, 50 Hz, 60 Hz, 400 Hz or d.c. (frequencies by IEC 61557-5).

Measurement function **2, 3, 4 – pole, Selective (Iron),
Wenner and Schlumberger method,**

Max noise interference voltage

on terminals H, S, ES and E30 V rms

Max noise interference current through:

Iron clamp (A1281)0.5 A rms

Max external magnetic field 100 A/m (No influence)

Injected noise frequency	Test frequency	Noise rejection (* See note)
400 Hz	55 Hz ... 164 Hz	> 60 dB
60 Hz	55 Hz	> 50 dB
	82 Hz ... 164 Hz	> 60 dB
50 Hz	55 Hz	> 50 dB
	82 Hz ... 164 Hz	> 60 dB
16 2/3 Hz	55 Hz ... 164 Hz	> 60 dB
d.c.	55 Hz ... 164 Hz	> 60 dB

Measurement function **2 Clamps**

Max noise interference current through:

Iron clamp (A1281) 3 A rms ($R_e < 20 \Omega$)

0.5 A rms ($R_e > 20 \Omega$)

Max external magnetic field 100 A/m (No influence)

Notes:

- Noise injection examples (voltage / current)

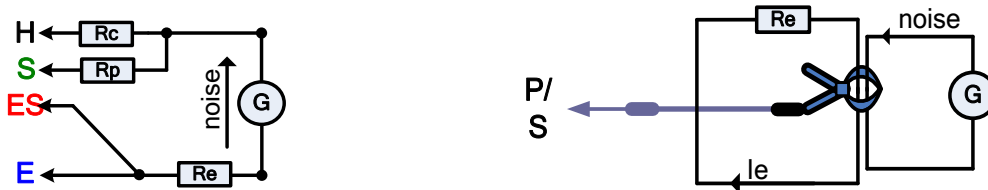

- Noise icon

	High electrical noise was detected during measurement. Results may be impaired. <i>Limit [Noise frequency is close ($\pm 10\%$) to the test frequency].</i>
--	---

- To high input measuring signals on terminals H, S, ES, E, Clamp. Possible reasons: max noise interference voltage or current have been reached; check the number of turns on flex clamps.

	The measuring range of the instrument is exceeded. Measurement could not be started or displayed!
--	---

- Signal-to-noise ratio

$$SNR_{db} = 20 * \log_{10} \left(\frac{A_{SIGNAL}}{A_{NOISE}} \right)$$

15.10.1 Digital filtering technique

The MI 3288 uses a high - resolution 7k SPS (samples per second) analog to digital converter to obtain all the different analog signals like input voltage (Uh), current (Ie), ... to digital results.

Example

Test objects description and schematics wiring diagram:

Selective (Flex Clamp)	
Re	10 Ω
Rc and Rp	2 kΩ
Test frequency	128 Hz
Ie	19.7 mA
Inoise	0.5 Arms @ 50 Hz
SNR	-28 dB

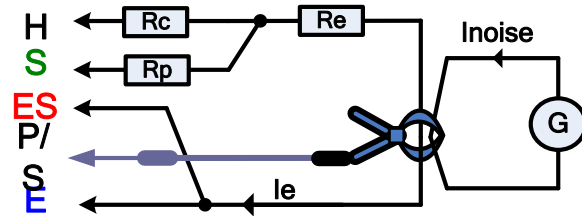

Using the Selective FFT filter algorithm.

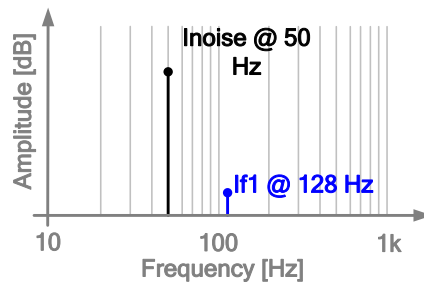

The MI 3288 will measure only analog signal (Ie) that is generated by the instrument and will filter out any other frequencies (Inoise). So, frequencies different from the measurement frequency will not influence on the measurement result.

15.11 Sub-results in measurement functions

Sub-result	Measuring range	Resolution	Uncertainty
Rp, Rc	0 Ω ... 49.9 kΩ	1 Ω ... 0.1 kΩ	±(8 % of reading + 3 digits)
Re	0.010 Ω ... 19.9 kΩ	0.001 Ω ... 0.1 kΩ	±(8 % of reading + 3 digits)
Ie	0.01 mA ... 999 mA	0.01 mA ... 1 mA	±(3 % of reading + 3 digits)
Ic	0.01 mA ... 9.99 A	0.01 mA ... 0.01 A	±(5 % of reading + 3 digits)
Zsel	0.001 Ω ... 19.9 kΩ	0.001 Ω ... 0.1 kΩ	±(8 % of reading + 3 digits)
f	16 Hz ... 499 Hz	1 Hz	±(0.2 % of reading + 1 digit)
Igen	0.01 mA ... 999 mA	0.01 mA ... 1 mA	±(2 % of reading + 2 digits)
Idc	0.01 mA ... 2.9 A	0.01 mA ... 0.1 A	±(2 % of reading + 2 digits)
R+	0 Ω ... 1.99 kΩ	1 μΩ ... 10 Ω	Indication only
R-	0 Ω ... 1.99 kΩ	1 μΩ ... 10 Ω	Indication only

15.12 General data

Battery power supply	7.2 V DC (4.4 Ah or 8.8 Ah Li-ion pack)
Battery charging time	typical 3 h (4400 mAh Li-ion pack, type: 18650T22A2S2P) typical 4.5 h (8800 mAh Li-ion pack, type: 18650T22A2S4P)
Charger socket input voltage	12 V \pm 10 %
Charger socket input current	3.0 A max.
Battery charging current	up to 2.2 A (4400 mAh Li-ion pack) up to 3.0 A (8800 mAh Li-ion pack)

Battery operation time:

Auto - off timer	10 min (idle state)
------------------------	---------------------

Measurement	Load conditions	The number of possible tests or time (continuous testing), with a fully charged battery.	
		4400 mAh Li-ion pack	8800 mAh Li-ion pack
Idle state	Brightness =100%	> 10 h	> 20 h
2, 3 – pole	Ze = 1 Ω , Rc = 200 Ω	> 1000 tests	> 2000 tests
4 – pole, Wenner, Schlumberger, Selective (Iron Clamp)		> 600 tests	> 1200 tests
2 Clamps	Ze = 10 Ω	5 h	10 h
Insulation Resistance	250 k Ω load @ 250 V	7 h	14 h
	1.0 M Ω load @ 1.0 kV	5 h	10 h
	2.5 M Ω load @ 2.5 kV	2.2 h	4.4 h
	2.5 M Ω load @ 2.5 kV (EN 61557-2)	> 600 tests	> 1200 tests
Ω - Meter (7mA)	R= 10 Ω	7 h	14 h
Ω - Meter (200mA)	R= 1 Ω (EN 61557-4)	> 1000 tests	> 2000 tests

Table 15.3: Typical battery operation time

Protection classification	reinforced insulation 
Measuring category	300 V CAT IV
Pollution degree	2
Degree of protection	IP 54 (with protective covers on USB, Charger and PS/2)
Operation	Outdoor use
Dimensions (w \times h \times d)	25 cm x 11 cm x 16 cm
Weight	1.6 kg (with 4400 mAh Li-ion pack) 1.8 kg (with 8800 mAh Li-ion pack)
Sound / Visual warnings	yes
Display	4.3" (10.9 cm) 480 \times 272 pixels TFT colour display with touch screen
EMC:	
Emission	Class B
Immunity	Basic EM environment
Reference conditions:	
Reference temperature range	25 $^{\circ}$ C \pm 5 $^{\circ}$ C
Reference humidity range	40 %RH ... 60 %RH
Operation conditions:	
Working temperature range	-10 $^{\circ}$ C ... 50 $^{\circ}$ C
Maximum relative humidity	90 %RH (0 $^{\circ}$ C ... 40 $^{\circ}$ C), non-condensing
Working nominal altitude	up to 2000 m up to 4000 m (derate to 600 V CAT II / 300 V CAT III)

Storage conditions:

Temperature range -10 °C ... 70 °C
Maximum relative humidity..... 90 %RH (-10 °C ... 40 °C)
80 %RH (40 °C ... 60 °C)

USB communication:

USB..... USB 2.0 Hi speed interface
Connector standard USB connector - type B

RS23 serial communication:

RS232 communication galvanic separated
Baud rate:..... 115200 bit/s
Connector PS/2

Bluetooth communication:

Device pairing code:..... 1234
Baud rate:..... 115200 bit/s
Bluetooth module class 2

Data:

Data storage capacity 8 GB SD memory card
PC software yes

Specifications are quoted at a coverage factor of $k = 2$, equivalent to a confidence level of approximately 95 %.

Accuracies apply for 1 year in reference conditions. Temperature coefficient outside these limits is 0.2 % of measured value per °C, and 1 digit.

Appendix A – Structure objects

Structure elements used in Memory Organizer are instrument’s Profile dependent.

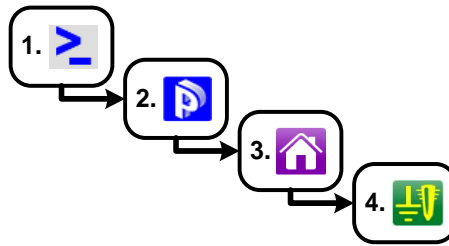



Figure A.2: Memory organizer hierarchy

Symbol	Default name	Parameters:
	Node	/
	Project	name of project, description of project;
	Building	name, description, location, type, nominal power, nominal voltage, GPS;
	Sub-Station	name, description, location, type, nominal power, nominal voltage, GPS;
	Power Station	name, description, location, type, nominal power, GPS;
	Transmission Tower	name, description, location, type, material type, nominal power, nominal voltage, GPS;
	Public Lighting	name, description, location, material type, nominal voltage, GPS;
	Object	name, description, location, GPS;
	Transformer	name, description, location, nominal power, nominal voltage, GPS;
	Lightning Rod	name, description, location, GPS;
	Grounding Rod	name, description, location, GPS;
	Mesh	name, description, location, GPS;
	Fence	name, description, location, GPS;
	Pipe	name, description, location, GPS;
	Test point	name, description, location, GPS;

Appendix B – Profiles Selection Table

Available profiles and measurement functions for the MI 3288:

Measurement functions available		Profile Code Name	AVAB MI 3288 EI
Group	Icon		
Voltage and Frequency Meter	Voltage	•	
2 – pole	Earth	•	
3 – pole	Earth	•	
4 – pole	Earth	•	
Selective (Iron Clamp)	Earth	•	
2 Clamps	Earth	•	
Wenner method	Specific	•	
Schlumberger method	Specific	•	
Step and Touch	Potential	•	
Ω - Meter (200 mA)	DC R	•	
Ω - Meter (7 mA)	DC R	•	
Insulation Resistance Mea...	Riso	•	
Diagnostic Measurement	Riso	•	
Varistor Test	Riso	•	
Current Clamp Meter	Other	•	
Safety Precautions Before Test	Visual	•	
Safety Hazards During Test	Visual	•	
After Test Reminder	Visual	•	
Safety Precautions (IEEE 81tm /5)	Visual	•	

Appendix C – Functionality and placing of test probes

For a standard earthing resistance two test probes (voltage and current) are used. Because of the voltage funnel it is important that the test electrodes are placed correctly. More information about principles described in this document can be found in the handbook: *Grounding, bonding, and shielding for electronic equipment and facilities*.

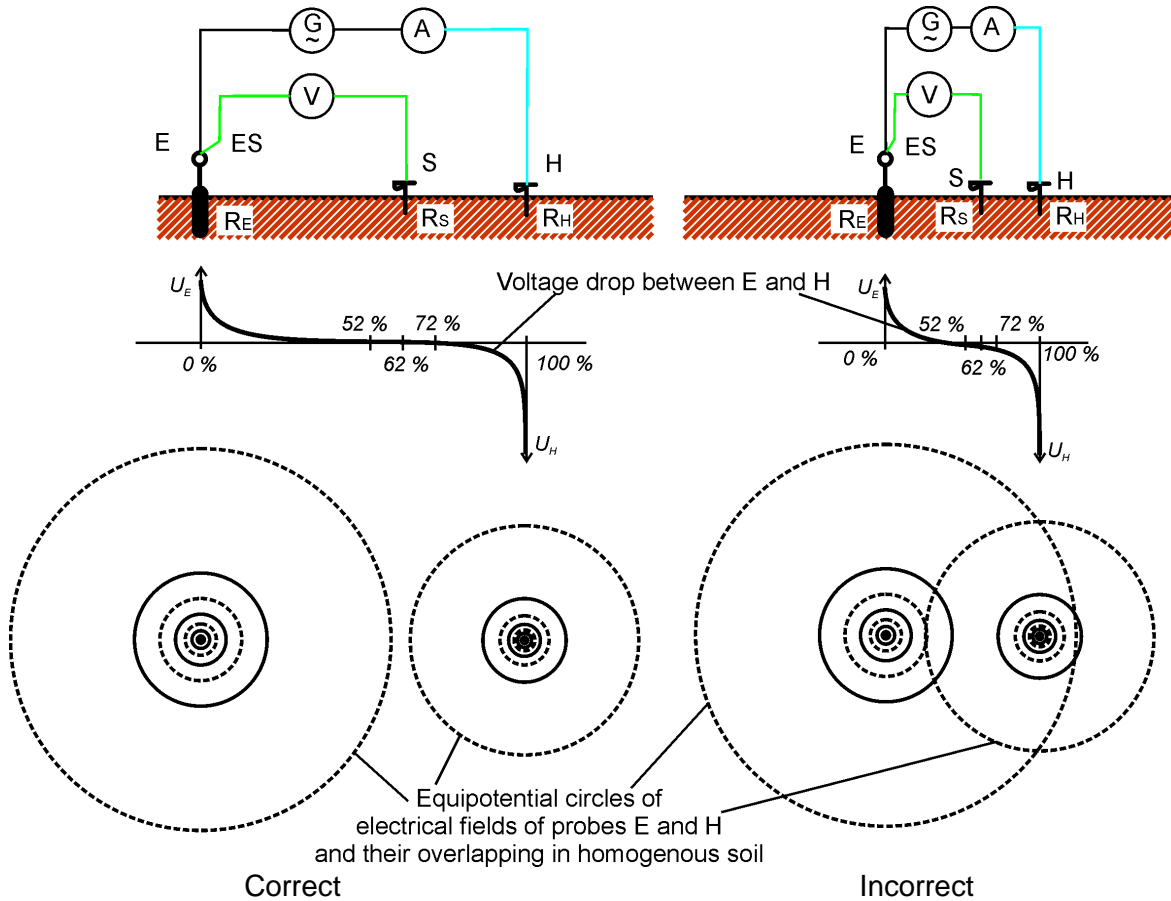

Figure C.1: Placement of probes

Probe E is connected to the earthing electrode (rod).

Probe H serves to close the measuring loop. The voltage between probe S and E is the voltage drop on the measured resistance. Correct placing of probes is essential. If the S probe is placed too close to the earthing system, then too small resistance will be measured (only a part of the voltage funnel would be seen).

If the S probe is placed too close to the H probe the earthing resistance of voltage funnel of the H probe would disturb the result.

It is important that the size of the earthing system is known, for the correct test probe placement. Parameter a represents the maximum dimension of the earthing electrode (or a system of electrodes) and can be defined acc. to Figure C.2.

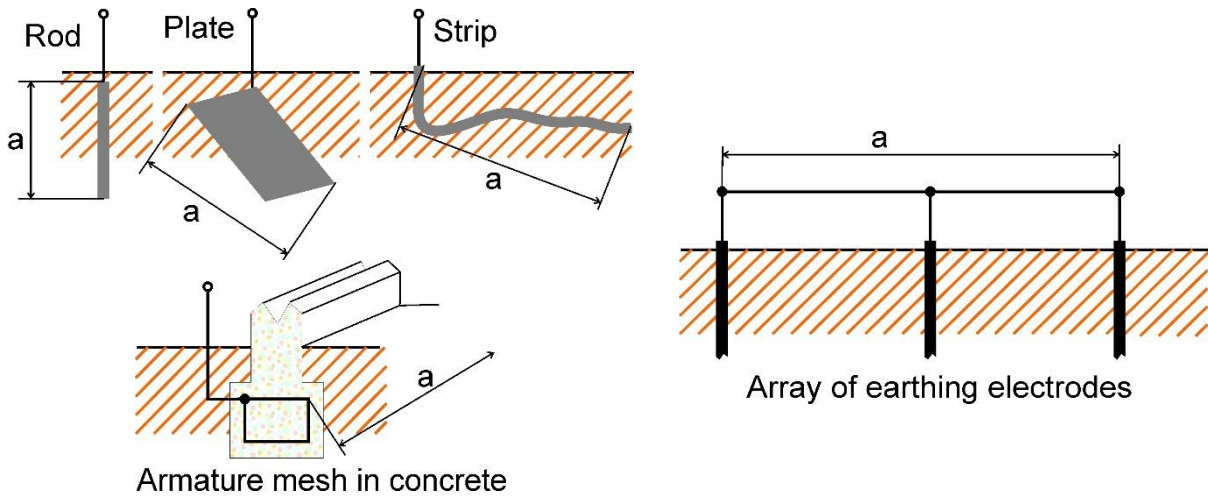

Figure C.2: Definition of parameter a

Straight-line placement

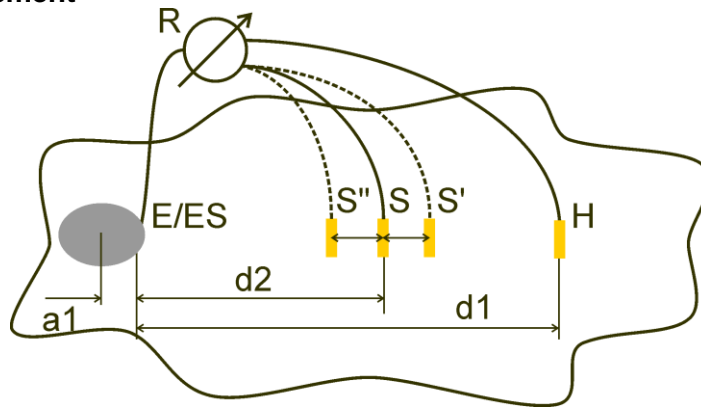

Figure C.3: Straight-line placement

After the maximum dimension **a** of an earthing system is defined then measurements can be performed by proper placement of test probes. A measurement with three placements of test probe S (S'', S, S') is intended to verify that the selected distance **d1** is long enough.

- Distance from tested earthing electrode system E/ES to current probe H shall be:

$$d_1 \geq 5a$$

- Distance from tested earthing electrode system E/ES to potential probe S shall be:

$$d_2 = 0,62d_1 - 0,38a_1 [\Omega]$$

a1 distance between connection point of earthing system and center.

Measurement 1

- Distance from earthing electrode E/ES to voltage probe S shall be:

$$d_2$$

Measurement 2

- Distance from earthing electrode E/ES to voltage probe S shall be:

$$d_2 = 0,52d_1 - 0,38a_1 (S'')$$

Measurement 3

- Distance from earthing electrode E/ES to voltage probe S shall be:

$$d_2 = 0,72d_1 - 0,38a_1(S')$$

In case of a properly selected d_1 the result of measurements 2 and 3 are symmetrical around the result of measurement 1. The differences (measurement 2- measurement 1, measurement 3 - measurement 2) must be lower than 10 %. Higher differences or non-symmetric results mean that the voltage funnels influence the measurement and the d_1 should be increased.

Notes:

- Initial uncertainty of measured resistance to earth depends on distance between electrodes d_1 and size of earthing electrode a . It can be seen in Table C.4: *Influence of d_1/a ratio to initial uncertainty.*

d_1/a	Uncertainty [%]
5	10
10	5
50	1

Table C.4: Influence of d_1/a ratio to initial uncertainty

- It is advisable for the measurement to be repeated at different placements of test probes.
- The test probes shall also be placed in the opposite direction from tested electrode (180° or at least 90°). The final result is an average of two or more partial results.
- According to IEC 60364-6 the distances $S'-S$ (measurement 2) and $S''-S$ (measurement 3) shall be 6 m.

Equilateral placement

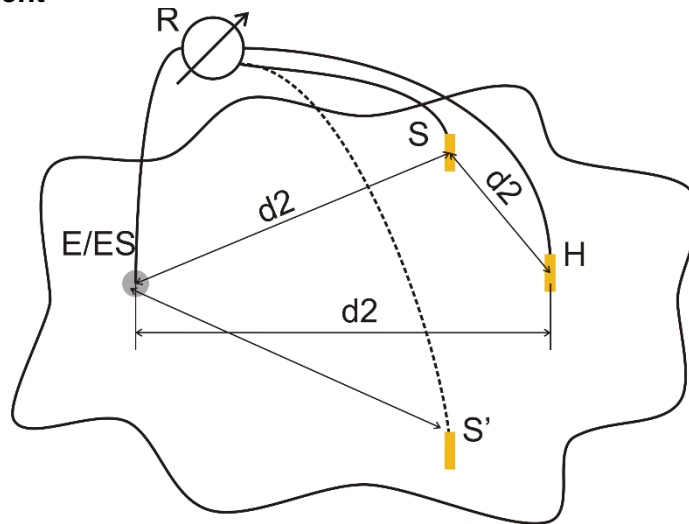

Figure C.4: Equilateral placement

Measurement 1

Distance from tested earthing electrode to current probe H and voltage probe S should be at least: $d_2 = 5 \cdot a$

Measurement 2

Distance from earthing electrode to voltage probe S (S'): d_2 , contrary side regarding to H

The first measurement is to be done at the S and H probes placed at a distance of d_2 . Connections E, probes H and S should form an equilateral triangle.

For the second measurement the S probe should be placed at the same distance d_2 on the contrary side regarding to the H probe. Connections E, probes H and S should again form an equilateral triangle. The difference between both measurements shall not exceed 10%. If a difference in excess of 10% occurs, distance d_2 should be proportionally increased and both measurements repeated. A simple solution is only to exchange test probes S and H (can be done at the instrument side). The final result is an average of two or more partial results.

It is advisable for the measurement to be repeated at different placements of test probes. The test probes shall be placed in the opposite direction from tested electrode (180° or at least 90°).

Test probe resistances

In general test probes should have a low resistance to earth. In case the resistance is high (usually because of dry soil) the H and S probes can significantly influence the measurement result. A high resistance of H probe means that most of the test voltage drop is concentrated at the current probe and the measured voltage drop of the tested earth electrode is small. A high resistance of S probe can form a voltage divider with the internal impedance of the test instrument resulting in a lower test result. Test probe resistance can be reduced by:

- ❑ Watering in the vicinity of probes with normal or salty water.
- ❑ Depleting electrodes under dried surface.
- ❑ Increasing test probe size or paralleling of probes.

METREL test equipment displays appropriate warnings in this case, according to IEC 61557-5. All METREL Earth testers measure accurate at probe resistances far beyond the limits in IEC 61557-5.

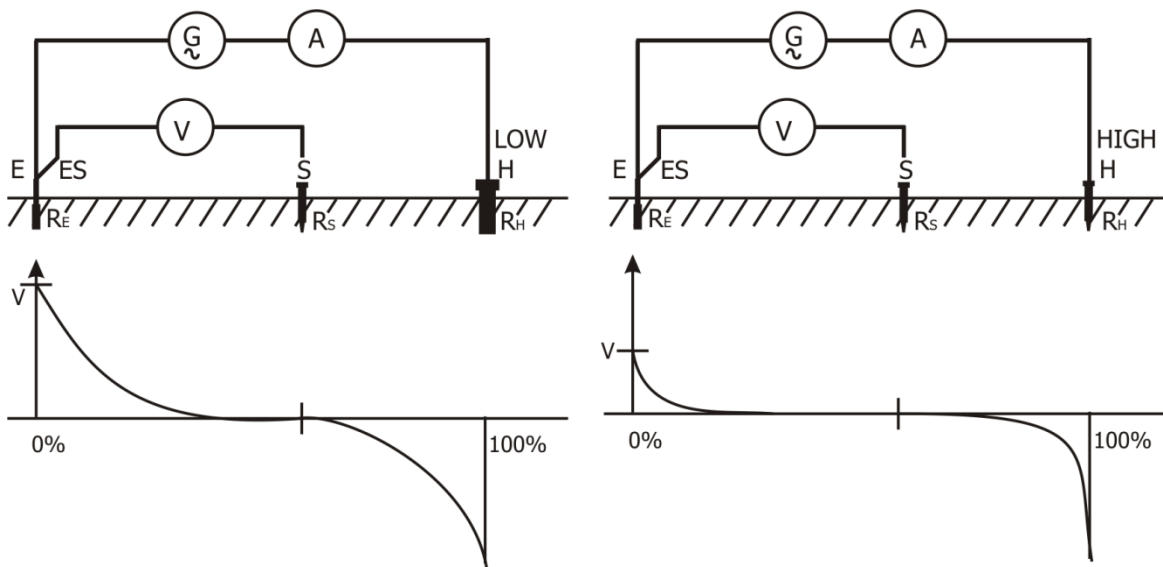
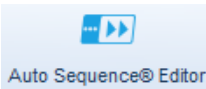

Figure C.5: Different measured voltage drops at low and high probe resistance

Appendix D – Programming of Auto Sequences® on Metrel ES Manager

The Auto Sequence® Editor is a part of the Metrel ES Manager software. In Auto Sequence® Editor an Auto Sequence® can be pre-programmed and organized in groups, before uploaded to the instrument.

D.1 Auto Sequence® Editor workspace

To enter Auto Sequence® Editor’s workspace, select  in Home Tab of Metrel ES Manager PC SW. Auto Sequence® Editor workspace is divided in four main areas. On the left side **1**, structure of selected group of Auto Sequence® is displayed. In the middle part of the workspace **2**, the elements of the selected Auto Sequence® are shown. On the right side, list of available single tests **3** and list of flow commands **4** are shown.

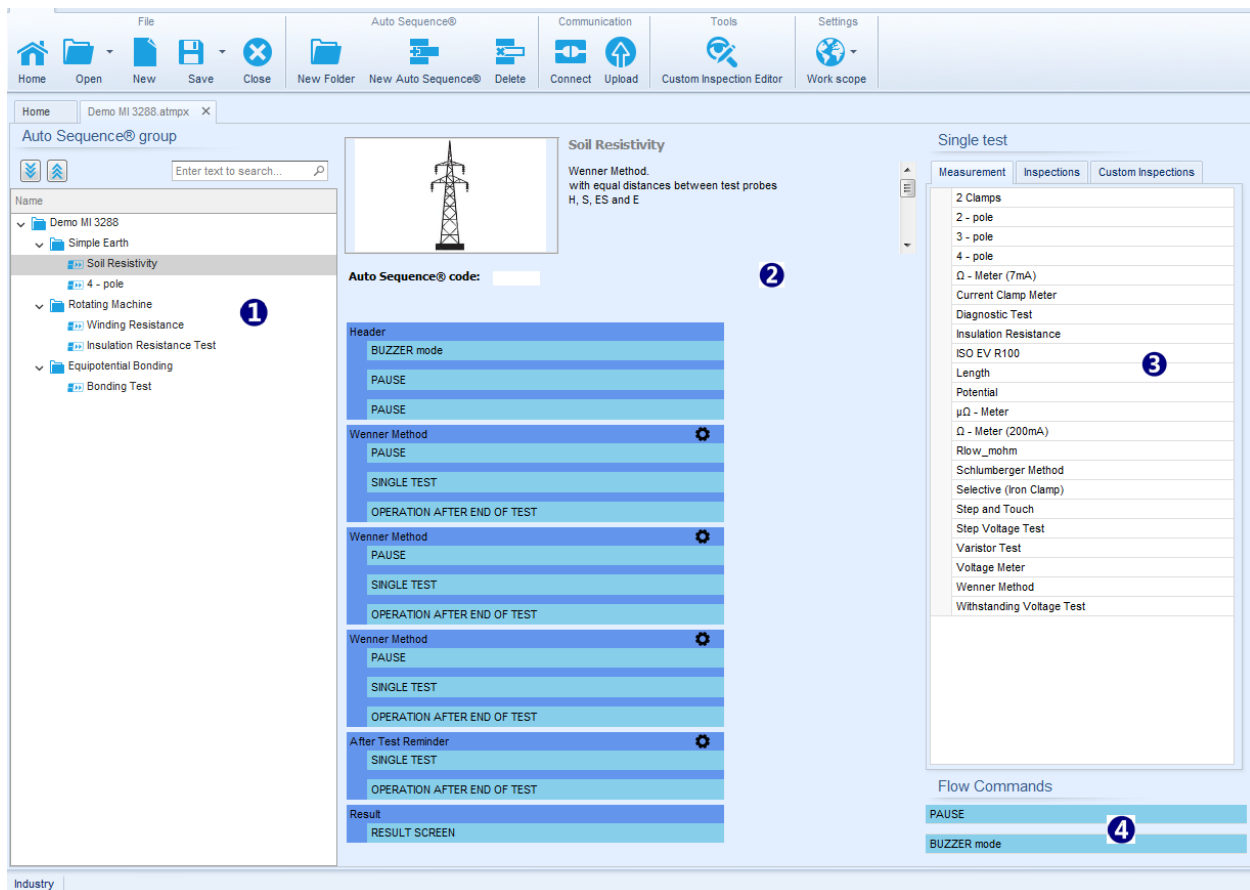

Figure D.1: Auto Sequence® Editor workspace

An Auto Sequence® **2** begins with Name, Description and Image, followed by the first step (Header), one or more measuring steps and ends with the last step (Result). By inserting

appropriate Single tests (measurements, inspections and custom inspections) **3** and Flow commands **4** and setting their parameters, arbitrary Auto Sequences® can be created.

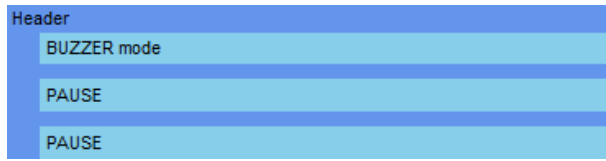

Figure D.2: Example of an Auto Sequence® header

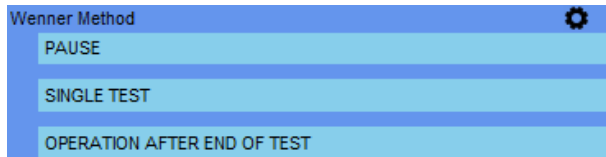

Figure D.3: Example of a measurement step



Figure D.4: Example of an Auto Sequence® result part

D.2 Managing groups of Auto Sequences®

The Auto Sequences® can be divided into different user defined groups of Auto Sequences®. Each group of Auto Sequences® is stored in a file. More files can be opened simultaneously in Auto Sequence® Editor.

Within Group of Auto Sequences®, tree structure can be organized, with folders / subfolders containing Auto Sequences®. The three structure of currently active Group of Auto Sequences® are displayed on the left side of the Auto Sequence® Editor workspace, see Figure D.5.

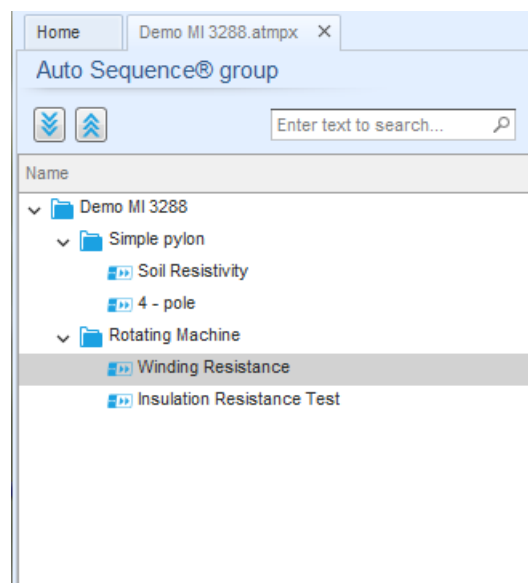

Figure D.5: Group of Auto Sequences® tree organization

Operation options on Group of Auto Sequences® are available from menu bar at the top of Auto Sequence® Editor workspace.

File operation options:



Opens starting Auto Sequence Editor screen.



Opens a file (Group of Auto Sequences®).



Creates a new file (Group of Auto Sequences®).



Saves / Saves as the opened Group of Auto Sequences® to a file.



Closes the file (Group of Auto Sequences®).

Group of Auto Sequence® view options:



Expand all folders / subfolders / Auto Sequences®.



Collapse all folders / subfolders / Auto Sequences®.



Search by name within Auto Sequence® group. See *Appendix D.2.2 Search within selected Auto sequence® group* for details.

Group of Auto Sequences® operation options (also available by right clicking on Folder or Auto Sequence®):



Adds a new folder / subfolder to the group



Adds a new Auto Sequence® to the group



Deletes:

- the selected Auto Sequence®
- the selected folder with all subfolders and Auto Sequences®

Right click on the selected Auto Sequence® or Folder opens menu with additional possibilities:

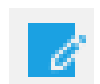

Auto Sequence®: Edit Name, Description and Image (see Figure D.6).
Folder: Edit folder name



Auto Sequence®: Copy to clipboard
Folder: Copy to clipboard including subfolders and Auto Sequences®





Auto Sequence®: Paste it to selected location
Folder: Paste it to selected location



Auto Sequence®: Creates shortcut to selected Auto Sequence®

Double click on the object name allows name edit:

**DOUBLE
CLICK**

Auto Sequence® name: Edit Auto Sequence® name  **Insulation Resistance Test**
Folder name: Edit folder name  **Rotating Machine**

Drag and drop of the selected Auto Sequence® or Folder / Subfolder moves it to a new location:

**DRAG &
DROP**



move to folder



insert

“Drag and drop” functionality is equivalent to “cut” and “paste” in a single move.

D.2.1 Auto Sequences® Name, Description and Image editing

When EDIT function is selected on Auto Sequence®, menu for editing presented on *Figure D.6* appear on the screen. Editing options are:

Name: Edit or change the name of Auto Sequence®.

Description: Any text for additional description of Auto Sequence® can be entered.

Image: Image presenting Auto sequence® measuring arrangement can be entered or deleted.





Enters menu for browsing to Image location.



Deletes the Image from Auto Sequence®.

Figure D.6: Editing the Auto Sequence® header

D.2.2 Search within selected Auto sequence® group

By entering the text into search box and click on the search  icon, found results are highlighted with orange background and first found result (Folder or Auto Sequence®) is focused. Click on the Search icon  again focus next search result. Search functionality is implemented in Folders, Subfolders and Auto Sequences® of selected Auto Sequence® Group. Search text can be cleared by selecting the Clear  button.

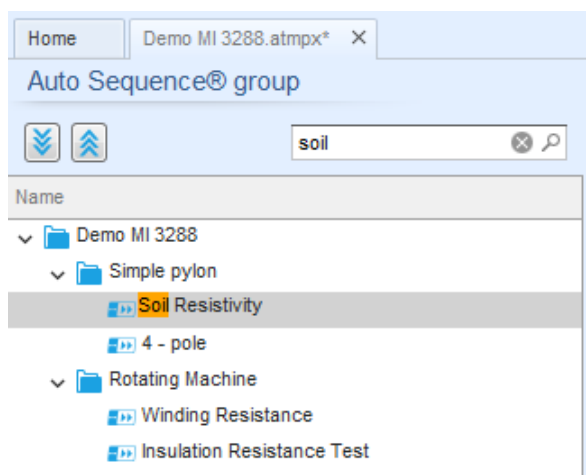

Figure D.7: Example of Search result within Auto Sequence® group

D.3 Elements of an Auto Sequence®

D.3.1 Auto Sequence® steps

There are three kinds of Auto Sequence® steps.

Header

The Header step is empty by default.

Flow commands can be added to the Header step.

Measurement step

The Measurement step contains a Single test and the Operation after end of test flow command by default. Other Flow commands can also be added to the Measurement step.

Result

The Result step contains the Result screen flow command by default. Other Flow commands can also be added to the Result step.

D.3.2 Single tests

Single tests are the same as in Metrel ES Manager Measurement menu.

Limits and parameters of the measurements can be set. Results and sub-results can't be set.

D.3.3 Flow commands

Flow commands are used to control the flow of measurements. Refer to chapter *D.5 Description of flow commands* for more information.

D.3.4 Number of measurement steps

Often the same measurement step has to be performed on multiple points on the device under test. It is possible to set how many times a Measurement step will be repeated. All carried out individual Single test results are stored in the Auto Sequence® result as if they were programmed as independent measuring steps.

D.4 Creating / modifying an Auto Sequence®

If creating a new Auto Sequence® from scratch, the first step (Header) and the last step (Result) are offered by default. Measurement steps are inserted by the user.

Options:

Adding a measurement step	By double clicking on a Single test a new measurement step will appear as the last of measurement steps. It can also be dragged and dropped on the appropriate position in the Auto Sequence®.
---------------------------	--

Adding flow commands	Selected flow command can be dragged from the list of Flow commands and dropped on the appropriate place in any Auto Sequence® step.
----------------------	--

Changing position of flow command inside one step	By a click on an element and use of  keys.
---	---

Viewing / changing parameters of flow commands or single tests.	By a double click on the element.
---	-----------------------------------

Setting number of measurement steps	By setting a number in the  field.
-------------------------------------	---

Right click on the selected measurement step / flow command

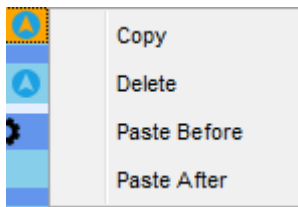

Copy – Paste before

A measurement step / flow command can be copied and pasted above selected location on the same or on another Auto Sequence®.

Copy – Paste after

A measurement step / flow command can be copied and pasted under selected location on the same or on another Auto Sequence®.

Delete

Deletes the selected measurement step / flow command.

Auto Save

Auto Sequence® results are stored in the momentary workspace.

A new Node with the date and time will be created. Under the Node Auto Sequence® results or (if Appliance info flow command is set) a new appliance and Auto Sequence® results will be stored.

Up to 100 Auto Sequence® results or appliances can be automatically stored under the same node. If more results / appliances are available, they are split to multiple nodes. Local Save Flow setting is disabled by default.

Note

- › This flow command is active only if Auto Sequence® is started from the Auto Sequence® Main menu (not from the Memory organizer).

D.6 Custom Inspection programming

Arbitrary set of tasks dedicated to specific user defined Inspections can be programmed with application of Custom Inspection Editor Tool, accessible from Auto Sequence® Editor workspace. Custom Inspections are stored in dedicated file *.indf with user defined name. For application of Custom Inspections as a single test within Auto Sequence® group, appropriate file containing specific Custom Inspection should be opened first.

D.6.1 Creating and editing Custom Inspections



Custom Inspection Editor workspace is entered by selecting Custom Inspection Editor icon from Auto Sequences® main menu. It is divided in two main areas, as presented on

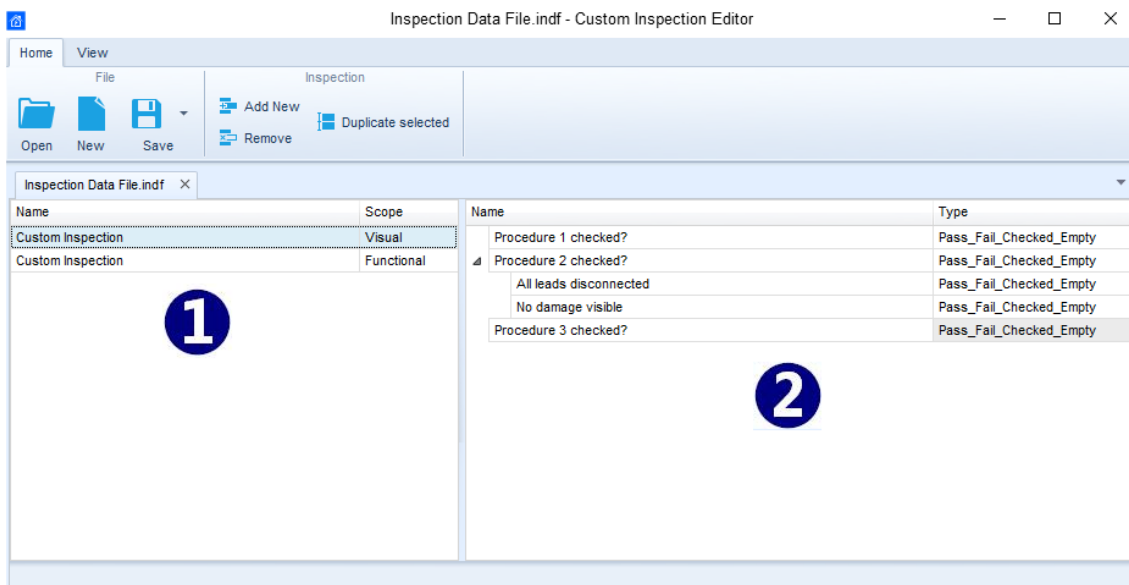





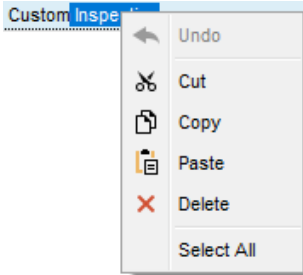
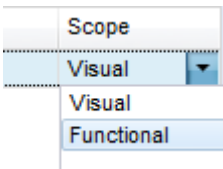

Figure D.8: Custom Inspection Editor workspace

Custom Inspection Editor Main menu options:

	<p>Opens existing Custom Inspection Data file.</p> <p>By selecting, menu for browsing to location of *.indf file containing one or more Custom Inspections data appear on the screen. Selected file is opened in dedicated tab marked with file name.</p>
	<p>Creates a new Custom Inspection Data file.</p> <p>New tab with empty workspace is opened. Default name of the new tab is <i>Inspection Data File</i>; it could be renamed during Save procedure.</p>
	<p>Saves / Saves as Custom Inspection Data file opened on active tab.</p> <p>Menu for browsing to the folder location and editing of file name is opened. Browse to the location, confirm overwriting, if file already exists or edit file name to save it as a new Custom Inspection Data file.</p>
	<p>Add New Custom Inspection.</p> <p>New inspection with default name <i>Custom Inspection</i> and default scope <i>Visual</i> appear on the editor workspace. It contains one Item task with default name <i>Custom Inspection</i> and default Type <i>Pass_Fail_Checked_Empty</i>. Default Name and Type can be edited – changed.</p>
	<p>Remove selected custom inspection.</p> <p>To select inspection, click to the inspection Name field. To remove it, select icon from editor main menu. Before removal, user is asked to confirm deletion.</p>
	<p>Duplicates selected Custom Inspection.</p> <p>Selected Custom Inspection including Scope and all Custom Inspection items and sub-items, or only selected Custom Inspection Item or sub-item including Type can be duplicated.</p>

Edit Name and Scope of Inspection

	<p>Inspection Name edit:</p> <p>Click to the Inspection Name field to start editing it. Drag cursor, with left mouse button pressed, to select letters and words. Position cursor and double-click to select word of the name. Actions could be performed with keyboard also. Press right mouse button to activate Edit menu and select appropriate action as presented on the left figure. Menu is case sensitive; options currently not available are greyed out.</p>
	<p>Inspection Scope edit:</p> <p>Click to Inspection Scope field to open selection menu presented on left figure. Options: Visual is intended for observation of test object Functional allows functional test of observed object</p>

Edit Item task structure of Inspection

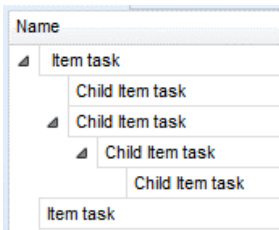
	<p>Item tasks of the selected Inspection are listed in Name column on the right side of Editor workspace.</p> <p>Each Item task can have Child Item tasks, Child Item can have its own Child Item tasks and so on.</p> <p>Arbitrary tree structure of Item tasks and subtasks can be built as presented on left figure.</p>
---	---

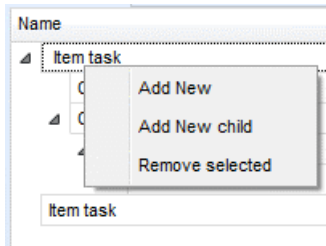

ADD New Item task procedure:

Position cursor above Item task Name and apply right mouse click to select Item task and open menu with options:

Add New: new Item task is added on the top tree level

Add New Child: new child Item task is added under selected Item

Remove selected: delete selected Item task with all subtasks

Default Name of New Item task is *Custom Inspection*, default Type *Pass_Fail_Checked_Empty* and both can be edited – changed.

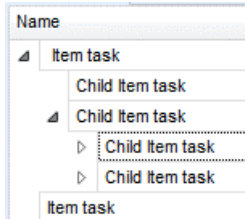

Item tasks containing Child Item tasks are marked with triangle in front of their Name.

Click on triangle mark:

- ▶ collapse Item task tree structure
- expands Item task tree structure

Edit Name and Type of Item task

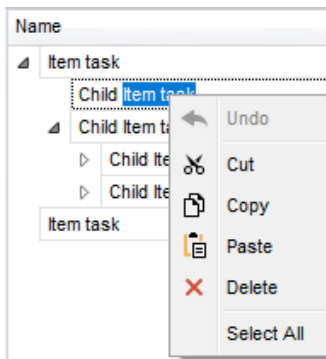

Edit Name of Item task:

Click to the Item task Name field to start editing it.

Drag cursor, with left mouse button pressed, to select letters and words. Position cursor and double-click to select word of the name. Actions could be performed with keyboard also.

Press right mouse button to activate Edit menu and select appropriate action as presented on the left figure. Menu is case sensitive; options currently not available are greyed out.

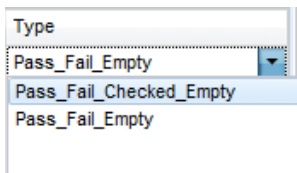

Edit Type of Item task:

Click to Item Type field to open selection menu presented on left figure. Selectable checkbox status assignment options are:

Pass_Fail_Checked_Empty: Pass, Fail, Checked, Empty (default)

Pass_Fail_Empty: Pass, Fail selection, Empty (default) value

D.6.2 Applying Custom Inspections

Custom inspections can be applied in Auto Sequences®. Direct assignment of Custom inspection to the Metrel ES manager structure objects is not possible.

After custom created Inspection Data file is opened, available inspections are listed in Custom Inspections tab of Single test area of Auto Sequence® Editor, see chapter *D.1 Auto Sequence® Editor workspace* for details.

Custom Inspection is added to Auto sequence as a Single test, see chapter *D.4 Creating / modifying an Auto Sequence®* for details.

Opening / changing Inspection Data File

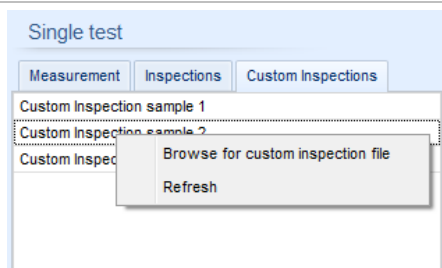

Position cursor within Custom inspections List area and apply mouse right click to open Option menu:

Refresh: Refresh content of already opened Inspection Data file.

Browse for custom Inspection file:

Menu for browsing to folder location of new Inspection Data file is opened.

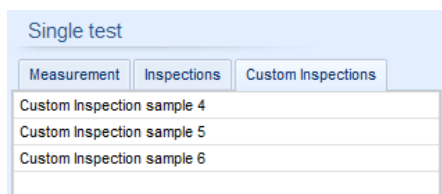

After confirmation of selection, new Inspection Data file is opened and list of available Custom Inspections is changed.

Note:

- › If Metrel ES Manager Work scope is changed, opened Inspection Data file remains active and available Custom Inspections remains the same.