



## DCM330

### Clampmeter

### User Guide

## 1. Safety Information

---

To ensure safe operation and service of the Meter, follow these instructions.

Failure to observe warnings can result in severe injury or death.

- Avoid working alone so assistance can be rendered.
- To enhance safety, test leads should be disconnected from instrument when not in use.
- Do not use test leads or the Clamp Meter if they look damaged.
- Do not use the Meter if the Clamp Meter is not operating properly or if it is wet.
- Use the Clamp Meter only as specified in the Instruction card or the protection provided by the Clamp Meter might be impaired.
- Special precautions are necessary when operating in situations where exposed live parts at dangerous voltages may be encountered. Personal protective equipment (not supplied with this instrument) should be used.
- To avoid false readings that could lead to electric shock and injury, replace the battery as soon as the low battery indicator (  ) appears.

### 1.1 Maintenance

Do not attempt to repair this Clamp Meter.











It contains no user-serviceable parts. Repair or serving should only be performed by qualified personal.

### 1.2 Cleaning

Periodically wipe the case with a dry cloth and detergent do not use abrasives or solvents.

### 1.3 Safety, Hazard and Warning symbols on the instrument

This paragraph details the various safety and hazard icons on the instrument's outer case.

Icon	Description
	Warning: High Voltage, risk of electric shock
	Caution: Refer to user guide.
	UK conformity. This equipment complies with current UK legislation
	EU conformity. Equipment complies with current EU directives.
	Equipment complies with current 'C tick' requirements.
	Do not dispose of in the normal waste stream.
	Equipment protected throughout by double insulation.
	Reference earth connection. Not a protective earth terminal
	Battery
	Application around and removal from hazardous live conductors is permitted

CAT IV - Measurement category IV: Equipment connected between the origin of the low-voltage mains supply and distribution panel.

CAT III - Measurement category III: Equipment connected between the distribution panel and electrical outlets.

CAT II - Measurement category II: Equipment connected between the electrical outlets and user's equipment.

CAT I - Measurement category I: The circuits are not connected to mains.

Measurement equipment may be safely connected to circuits at the marked rating or lower. The connection rating is that of the lowest rated component in the measurement circuit.

## 2. Operation

### 2.1 Power On / Off

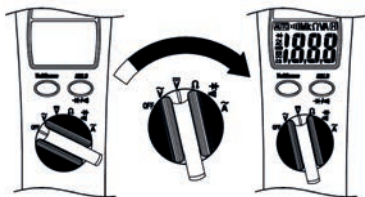

### 2.2 Auto Power Off

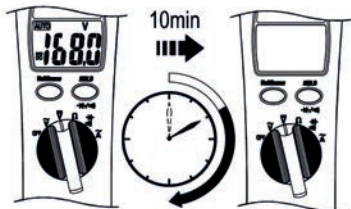

The meter will automatically shut itself off after approximately 10 minutes after power on.

### 2.3 AC V / DC V

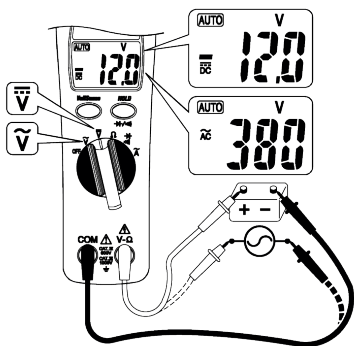

### 2.4 Data Hold

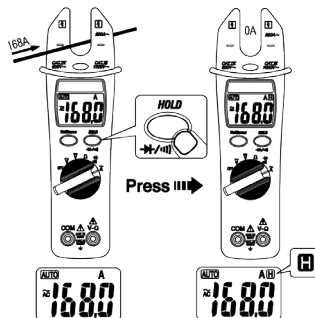

### 2.5 Volt Finder

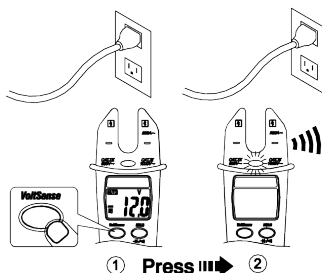

1. Volt Finder can be activated on any range including OFF.
2. Test leads are not used for the Volt Finder function.
3. Press and hold the Volt Finder button. The display will go black, a tone sounds and the red LED near the fork jaw will illuminate briefly to verify that the instrument is operational. Continue to hold the Volt Finder button.
4. If a voltage of 50 V to 1000 V (50 to 500 Hz) is detected near the jaw, a continuous tone sounds and the red LED near the jaw illuminates.

## 2.6 Diode / Continuity

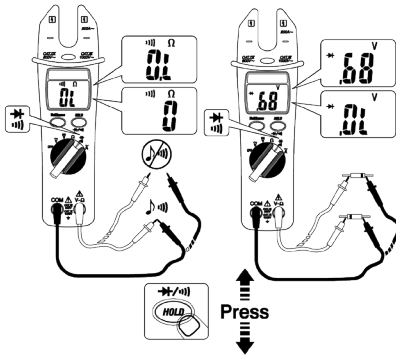

## 2.8 ACA

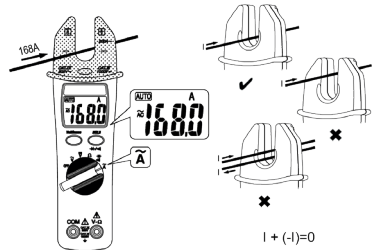

⚠ CAT.IV.600 V with respect to earth for the jaw. Tactile Barrier for hand guard.

⚠ Do not hold the meter in front of the Tactile Barrier.

## 2.7 Resistance

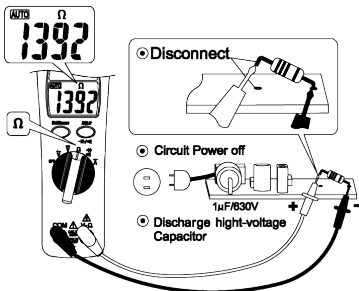

## 2.9 Battery Replacement

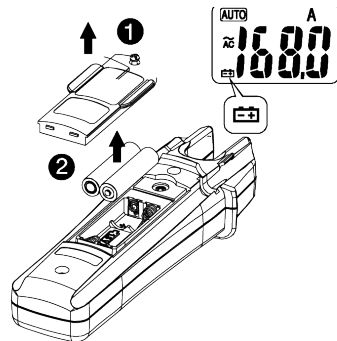

To avoid false readings that could lead to electric shock and injury, replace the battery as soon as the low battery indicator (  ) appears.

### 3. Specifications

Specification	Detail
<b>1-1 General Specifications</b>	
LCD display digits :	3 1/2 digit large scale LCD readout.
Display count :	2000 counts.
Measuring rate :	1.5 times / sec.
Overrange display :	"OL" is displayed for "Ω" functions, shows the real value for "A" and "V" function.
Automatic power off time :	Approximately 10 minutes after power on.
Low battery indicator :	 is displayed. Replace battery immediately
Power requirement :	R03 UM4 AAA 1.5 V x 2 batteries
Battery life :	ALKALINE 250 hours. Not suitable for use with rechargeable cells.
<b>1-2 Environmental Conditions</b>	
Indoor Use.	
Calibration :	One year calibration cycle.
Operating temperature :	0 °C ~ 30 °C (±80% RH) 30 °C ~ 40 °C (±75% RH) 40 °C ~ 50 °C (±45% RH)
Storage temperature :	-20 to +60 °C, 0 to 80% RH (batteries not fitted).
Dimensions (W x H x D) :	54 mm x 193 mm x 31 mm
Weight :	280 g including battery.
Accessories :	Battery (installed), Carrying case and User manual.
Overvoltage category :	IEC 61010-1 1000 V CAT.III. 600 V CAT.IV.
Operating altitude :	2000 m (6562 ft)
Conductor Size :	16 mm diameter.
Pollution degree :	2
EMC :	EN 61326-1
Shock vibration :	Sinusoidal vibration per MIL-T- 28800E (5 ~ 55 Hz, 3 g maximum).
Drop Protection :	1.2 m drop to hardwood on concrete floor.

**1-3 Electrical Specifications**

Accuracy is  $\pm(\% \text{ reading} + \text{number of digits})$  at  $23\text{ }^{\circ}\text{C} \pm 5\text{ }^{\circ}\text{C} < 80\% \text{RH}$ .

Temperature coefficient : Add  $0.2 \times (\text{Specified accuracy}) / ^{\circ}\text{C}$ ,  $< 18\text{ }^{\circ}\text{C}$ ,  $> 28\text{ }^{\circ}\text{C}$  .

DC / AC Volts	Range DC	Accuracy	AC Accuracy
	200.0 V	$\pm(1.0\% + 2\text{dgt})$	$\pm(1.5\% + 5\text{dgt})$ 50 Hz ~ 500 Hz
	1000 V		

Over voltage protection : DC / AC1000 V

Input Impedance :  $2\text{ M}\Omega // \text{less than } 100\text{ pF}$ .

CMRR / NMRR : (Common Mode Rejection Ratio) (Normal Mode Rejection Ratio)

VAC : CMRR  $> 60\text{ dB}$  at DC, 50 Hz / 60 Hz

VDC : CMRR  $> 100\text{ dB}$  at DC, 50 Hz / 60 Hz NMRR  $> 50\text{ dB}$  at DC, 50 Hz / 60 Hz

AC Conversion Type : Average sensing rms indication.

AC Current	Function	Range	Accuracy
	A~ (50~60 Hz)	0.0 ~ 200.0 A	$\pm(3.0\% + 3\text{dgt})$

Overload protection : 400 Arms

AC Conversion Type : Average sensing rms indication.

\* Adjacent conductor influence :  $< 0.08\text{ A/A}$

Resistance	Range	Accuracy
	200.0 $\Omega$	$\pm(1.0\% + 2\text{dgt})$
	2.000 K $\Omega$	
	20.00 K $\Omega$	
	200.0 K $\Omega$	
	2.000 M $\Omega$	
20.00 M $\Omega$	$\pm(1.9\% + 5\text{dgt}) * 1$	

Overload protection : 600 Vrms

Open circuit Voltage : -1.3 V approx.  
\* 1  $< 100\text{ dgt}$  rolling.  
\* 2  $< 10\text{ dgt}$  rolling.

## Specifications

Diode Check and Continuity	Resolution	Accuracy
	1 mV	$\pm(1.5\%+0.05\text{ V})^*$
* For 0.4 V ~ 0.8 V		
Max. Test Current :	1.5 mA	
Max. Open Circuit Voltage :	3 V	
Overload Protection :	600 Vrms	
Continuity :	Internal beeper activates if the resistance of the circuit under test is less than 50 $\Omega$ . It will then turn off if the resistance is increased beyond 250 $\Omega$ . Response time is approximately 0.25~1 sec.	



## 4. Limited Warranty

---

This Meter is warranted to the original purchaser against defects in material and workmanship for 1 year from the date of purchase. During this warranty period, manufacturer will, at its option, replace or repair the defective unit, subject to verification of the defect or malfunction.

This warranty does not cover , disposable batteries, or damage from abuse, neglect, accident, unauthorized repair, alteration, contamination, or abnormal conditions of operation or handling.

Any implied warranties arising out of the sale of this product, including but not limited to implied warranties of merchantability and fitness for a particular purpose, are limited to the above. The manufacturer shall not be liable for loss of use of the instrument or other incidental or consequential damages, expenses, or economic loss, or for any claim or claims for such damage, expense or economic loss. Some states or countries laws vary, so the above limitations or exclusions may not apply to you.

## 5. Decommissioning

---

### 5.1 WEEE Directive

The crossed out wheeled bin symbol placed on Megger products is a reminder not to dispose of the product at the end of its life with general waste.

Megger is registered in the UK as a Producer of Electrical and Electronic Equipment. The Registration No is WEE/ HE0146QT.

For further information about disposal of the product consult your local Megger company or distributor or visit your local Megger website.

### 5.2 Battery disposal

The crossed out wheeled bin symbol placed on a battery is a reminder not to dispose of batteries with general waste when they reach the end of their usable life.

For disposal of batteries in other parts of the EU contact your local Megger branch or distributor.

Megger is registered in the UK as a producer of batteries (registration No.: BPRN00142).

For further information see [www.megger.com](http://www.megger.com)



## Manufacturing sites

---

Megger Limited

Archcliffe Road

Dover

Kent

CT17 9EN

ENGLAND

T. +44 (0)1 304 502101

F. +44 (0)1 304 207342

Megger USA - Dallas

4545 West Davis Street

Dallas TX 75237

USA

T. 800 723 2861 (USA only)

T. +1 214 333 3201

F. +1 214 331 7399

E. USsales@megger.com

Megger GmbH

Weststraße 59

52074 Aachen

T. +49 (0) 241 91380 500

E. info@megger.de

Megger AB

Rinkebyvägen 19, Box 724,

SE-182 17

DANDERYD

T. +46 08 510 195 00

E. seinfo@megger.com

Megger USA - Valley Forge

Valley Forge Corporate Center

2621 Van Buren Avenue

Norristown

Pennsylvania, 19403

USA

T. +1 610 676 8500

F. +1 610 676 8610

Megger USA - Fort Collins

4812 McMurry Avenue

Suite 100

Fort Collins CO 80525

USA

T. +1 970 282 1200

The company reserves the right to change the specification or design without prior notice.

Megger is a registered trademark