

USER GUIDE

AVO[®]850

Megger[®]

TRMS Industrial Logging Digital Multimeter with Colour Display



Register →
megger.com/register



User Guide →



Support →
megger.com/support



EN
ENGLISH

This document is copyright of:

Megger Limited, Archcliffe Road, Dover, Kent CT17 9EN. ENGLAND
T +44 (0)1304 502101 F +44 (0)1304 207342 www.megger.com

Megger Ltd reserves the right to alter the specification of its products from time to time without notice. Although every effort is made to ensure the accuracy of the information contained within this document it is not warranted or represented by Megger Ltd. to be a complete and up - to - date description.

For Patent information about this instrument refer to the following web site:
megger.com/patents

This manual supersedes all previous issues of this manual. Please ensure that you are using the most recent issue of this document. Destroy any copies that are of an older issue.

Declaration of Conformity

Hereby, Megger Instruments Limited declares that radio equipment manufactured by Megger Instruments Limited described in this user guide is in compliance with Directive 2014/53/EU. Other equipment manufactured by Megger Instruments Limited described in this user guide is in compliance with Directives 2014/30/EU and 2014/35/EU where they apply.

The full text of Megger Instruments EU declarations of conformity are available at the following internet address:
megger.com/eu-dofc

Contents

1. Introduction.....	7
1.1 Company web site.....	7
2. Safety warnings and standards	8
2.1 Warnings, cautions and notes.....	8
2.2 Safety warnings.....	8
2.2.1 Installation category definitions:.....	9
2.3 Safety, hazard and warning symbols on the instrument.....	9
2.4 Input protection limits.....	11
2.5 Features	11
3. Instrument overview.....	12
3.1 Unpacking and inspection.....	12
3.2 Instrument layout.....	12
3.3 Softkeys.....	13
3.4 Terminals.....	13
3.5 Display.....	14
3.6 Rotary switch.....	15
4. Operation	16
4.1 Current measurements	16
4.1.1 4 - 20 mA % measurements.....	17
4.1.2 DC current measurements.....	18
4.1.3 AC current measurements.....	19
4.2 Voltage measurement.....	21
4.2.1 V AC voltage measurements	21
4.2.2 V DC voltage measurement.....	22
4.2.3 V AC + DC measurements	23
4.2.4 Milli-Volts voltage measurements.....	24
4.3 Frequency measurements.....	25
4.4 Resistance, continuity, capacitance and diode testing	26
4.4.1 Resistance measurements.....	26
4.4.2 Continuity check	27
4.4.3 Diode test.....	28
4.4.4 Capacitance measurements.....	30
4.5 Temperature measurements.....	31

5. Default display	32
5.1 Graph measure.....	32
5.2 Capturing minimum and maximum values	33
5.3 Capturing peak values	34
5.4 Relative values.....	34
6. Save functions	35
6.1 Storing individual measurement data	35
6.2 Recording measurement data.....	35
6.3 Delete.....	37
6.4 Viewing graph data	38
6.5 Data recall.....	38
6.6 Viewing trend data	39
6.7 Info.....	39
7. Setup options	40
7.1 Factory reset	40
7.2 Format.....	41
7.2.1 Beeper On/Off.....	41
7.2.2 Numeric format	42
7.2.3 Setting date format.....	42
7.2.4 Setting time format.....	43
7.3 Display settings.....	43
7.3.1 Setting date and time	44
7.3.2 Battery saver auto power off (APO).....	45
7.3.3 Foreground and background.....	45
7.3.4 Set font	46
7.4 Meter info.....	46
7.5 Bluetooth.....	47
8. Maintenance	48
8.1 General maintenance.....	48
8.2 Cleaning.....	48
8.3 Battery	48
8.3.1 Battery status.....	48
8.4 Maintenance	48

9. Battery and fuse replacement	49
9.1 Replacing the battery and fuses.....	49
9.1.1 Test the fuses	50
9.2 Li-ion battery charge.....	51
10. Specifications.....	52
10.1 Electrical specifications	53
10.1.1 AC voltage	53
10.1.2 DC voltage.....	53
10.1.3 (AC+DC).....	53
10.1.4 Resistance.....	54
10.1.5 Temp (type-K)	54
10.1.6 DC current.....	54
10.1.7 AC current.....	54
10.1.8 Capacitance.....	55
10.1.9 Electronic frequency.....	55
10.1.10 Electrical frequency.....	55
10.1.11 Duty cycle	55
10.2 Safety	56
11. Calibration, repair and warranty	57
11.1 Limited warranty.....	57
11.2 Repair and warranty	57
11.3 Instrument repair and spare parts	57
11.4 Returning and instrument for repair	57
11.5 Calibration, service and spare parts	58
11.6 Approved repair companies	58
12. Decommissioning	59
12.1 WEEE Directive	59
12.2 Battery disposal.....	59
13. Worldwide sales offices.....	60

1. Introduction

The AVO®850 is a professional True-RMS digital multimeter with TFT colour LCD screen 50 000 count display and includes handy bar graph, capture and Bluetooth feature's. Designed for precision and convenience, this high-accuracy multimeter that runs on rechargeable batteries.

The meter meet CAT III and CAT IV IEC 61010-1 standards. The IEC 61010-1 safety standard defines four measurement categories (CAT I to IV) based on the magnitude of danger from transient impulses. See below for further information.

Read the ensuing safety regulations attentively before using this device.

1.1 Company web site

Occasionally an information bulletin may be issued via the Megger web site. This may concern new accessories, new usage instructions or a software update. Please occasionally check on the Megger web site for anything applicable to your Megger instruments.

www.megger.com

2. Safety warnings and standards

These safety warnings must be read and understood before the instrument is used. Retain for future reference.

2.1 Warnings, cautions and notes

This user guide follows the internationally recognised definition. These instructions must be adhered to at all times.

Description

WARNING : Indicates a potentially dangerous situation which, if ignored, could lead to death, serious injury or health problems.

CAUTION : Indicates a situation which could lead to damage of the equipment or environment

NOTE : Indicates important instructions to be followed to perform the relevant process safely and efficiently.

2.2 Safety warnings

- Understand and follow the operating instructions carefully.
- No user serviceable parts inside.
- Lithium coin cell contained in side.

The following safety information must be observed to ensure maximum personal safety during the operation of this meter:

- Do not use it in wet environments.
- Measurements beyond the maximum selected range must not be attempted.
- Extreme care must be taken when measuring above 50 V, especially on live exposed contacts.
- To measure voltage, the multimeter must **not** be switched to a current or resistance range, or to the diode check or buzzer position.
- Circuits must be de-energised and isolated before carrying out resistance tests.
- The rotary selector switch must only be turned after removing test connections.
- To avoid false readings that could lead to electric shock and injury, replace the battery as soon as the low battery indicator () appears.
- This multimeter contains a coin battery. A coin battery can cause serious internal chemical burns if swallowed.
- All external voltages must be disconnected from the multimeter before removing the battery.
- Never operate the meter unless the back cover and the fuse/battery cover is correctly in place and fastened securely with the manufactured supplied fastenings.
- The battery door must be closed and locked before you operate the multimeter.
- Test leads and prods must be in good order, and free from defects e.g. broken or cracked insulation.
- UK Safety Authorities recommend the use of fused test leads when measuring voltage on high energy systems.

- Replacement fuses must be of the correct type and rating.
- The multimeter must not be used if any part of it is damaged.
- Check for correct multimeter operation by testing a known voltage before and after use. Do not use it if misleading results are obtained.
- Warnings and precautions must be read and understood before an multimeter is used. They must be observed during the operation of this multimeter.
- When using test leads or probes, keep your fingers behind the finger guards.
- Personal protective equipment should be used if there are ACCESSIBLE HAZARDOUS LIVE PARTS in the installation where measurement is to be carried out.
- Do not use the meter around explosive gas or vapour.
- Do not apply or remove test leads on or around uninsulated hazardous live conductors where a potential to cause electric shock, electrical burns or arc flash exists.

2.2.1 Installation category definitions:

CAT IV - Measurement category IV: Equipment connected between the origin of the low-voltage mains supply and distribution panel.





CAT III - Measurement category III: Equipment connected between the distribution panel and electrical outlets.

CAT II - Measurement category II: Equipment connected between the electrical outlets and user's equipment.











Measurement equipment may be safely connected to circuits at the marked rating or lower. The connection rating is that of the lowest rated component in the measurement circuit.

2.3 Safety, hazard and warning symbols on the instrument

Disconnect the test leads from the test points before changing the position of the function rotary switch. Never connect a source of voltage with the function rotary switch in Ω , $-|(-$, and \downarrow position. Do not expose meter to extremes of temperature or high humidity.

Icon	Description
	Warning: High voltage, risk of electric shock
	Caution: Refer to user guide
	UK conformity. This equipment complies with current UK legislation
	EU conformity. Equipment complies with current EU directives
	Conforms to relevant Australian Safety and EMC standards

Safety warnings and standards

	AC measurement
	DC measurement
	Direct and alternating current
	Equipment protected by double or reinforced insulation
	Battery
	Earth
	Fuse
	Application around and removal from hazardous live conductors is permitted
	Do not dispose of to landfill, sewage systems or by fire
	This multimeter contains a coin battery
	This multimeter contains a Lithium-ion battery. Do not mix with the solid waste stream. Spent batteries should be disposed of by a qualified recycler or hazardous materials handler per local regulations. Contact your authorized Megger Service Centre for recycling information. The terminal(s) must not be connected to a circuit point at which the voltage with respect to earth ground exceeds (in this case) 1000 VAC or VDC

2.4 Input protection limits

NEVER apply voltage or current to the multimeter that exceeds the specified maximum:

Function	Maximum Input
V DC	1000 V DC RMS
V AC	1000 V AC RMS
mA AC/DC	800 mA
A AC/DC	10 A
Frequency, resistance, capacitance, duty cycle, diode test, continuity	1000 V DC / AC RMS
Temperature	1000 V DC / AC RMS
Surge Protection	8 kV peak per IEC 61010

Unsafe voltage

WARNING : When the multimeter detects a potentially hazardous voltage, ≤ 30 V or a voltage overload (OL) in V mode, the symbol is displayed.

2.5 Features

- Safety rated CAT III 1000 V, CAT IV 600 V
- Accurate True-RMS AC current and voltage
- High accuracy ($\pm 0.05\%$)
- Measure frequency up to 10 MHz
- Resistance, continuity, and diode measurements
- 10 mF capacitance range
- Bright back-light display
- High resolution 50 000 counts 320 x 240 TFT colour LCD
- Current measurement to 10 A
- Analogue bar graph
- IP40 (waterproof and dust-proof) rating
- Designed and tested to withstand a 2 m (6.6 ft) drop
- Li-ion rechargeable battery
- AC Adapter and charger
- Bluetooth interface and Megger AVO Link App for Android devices

3. Instrument overview

3.1 Unpacking and inspection

Upon removing your new multimeter from its packing, you should have the following items:

- AVO850 Multimeter
- 1 m 4 mm non-fused, right angle test leads* (x2)
- 4 mm exposed metal probes* (x2)
- Exposed tip probes for CAT II probing (x2)
- Red + Black crocodile clips*
- K-type multimeter adapter
- K-type thermocouple lead
- Soft case
- 4 mm cap plugs (x2)
- User guide available online
- Lithium polymer rechargeable battery (1200 mAh 7.4 V 8.88 Wh)
- Universal mains charger



*Ratings: Double insulated, CAT III 1000 V, CAT IV 600 V, 10 A max

3.2 Instrument layout

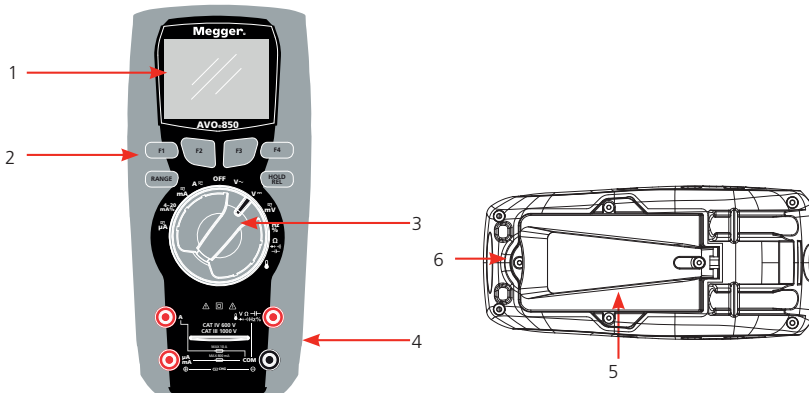

Item	Description	Item	Description
1.	50 000 counts 320 x 240 TFT colour LCD	4.	Terminals
2.	Softkeys	5.	Tilt stand
3.	Function switch	6.	Fuse and battery cover

3.3 Softkeys

The softkeys on the front of the multimeter activate features within each function selected from the rotary switch, navigate menus or control power to multimeter circuits.

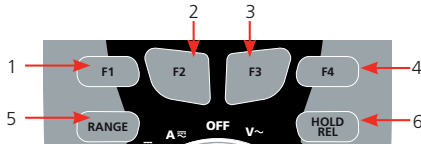

Item	Softkey	Function
1.	F1 button	Graph measurement display
2.	F2 button	Switches between display information
3.	F3 button	Save menu
4.	F4 button	Displays and starts recording Max, Min and Average measurement values
5.	Range button	Into manual range and select range of the measure. Press the Range button for more than 1 second to return Auto Range
6.	HOLD REL	Freezes the present reading in the display and allows the display to be saved. Press the HOLD/REL >1 second will change to relative mode

3.4 Terminals

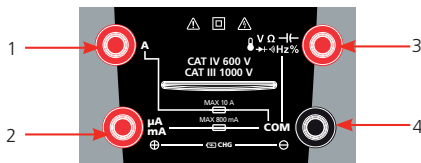

All functions except current use the VΩ and COM input terminals. The two current input terminals.

Item	Description	Item	Description
1.	10 A Input terminal. Input for 0 A to 10.00 A current	3.	Positive input terminal. Input for voltage, continuity, resistance, diode test, capacitance, frequency and temperature
2.	μA mA Input terminal. Input for 0 A to 500 mA current	4.	Common input terminal. Return terminal for all measurements

3.5 Display

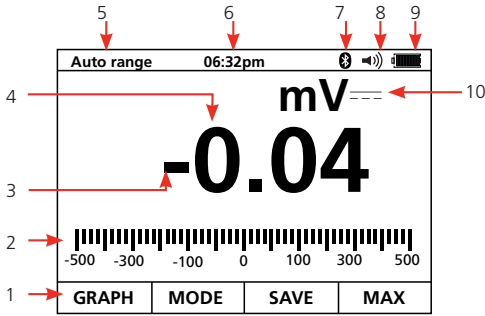

Item	Description	Item	Description
1.	Softkey labels - the function of the button just below the displayed label	6.	Time set on the internal clock
2.	Bar graph - Analogue display measurement	7.	Bluetooth is connected
3.	Minus sign - a negative reading	8.	Beeper is enabled (not associated with the continuity beeper)
4.	Digital displays measurement	9.	Battery charge level
5.	The range the Meter is in and the ranging mode (auto or manual)	10.	Units of measure

3.6 Rotary switch

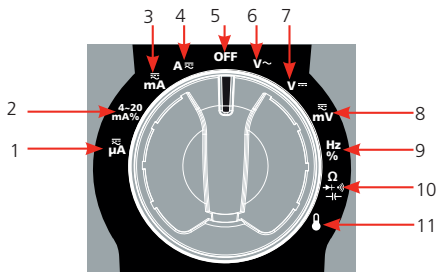

Turn the rotary switch to select a measurement function.

Item	Function Switch	Function
1.	μA AC/DC	AC, DC micro-amps measurements
2.	4~20 mA %	% 4-20 milli-amps measurements
3.	mA AC/DC	AC, DC milli-amps measurements
4.	A AC/DC	AC, DC amps measurements up to 5000 μA
5.	OFF	
6.	V AC	AC voltage measurements
7.	V DC	DC and AC+DC voltage measurements
8.	mV AC/DC	DC(AC) milli-volts measurements
9.	Hz %	Frequency measurements
10.	Ohms Diode Continuity Capacitance	Resistance, diode test, capacitance and continuity measurements
11.	Temperature	Temperature measurements

4. Operation

WARNING : Risk of electrocution. High-voltage circuits, both AC and DC, are very dangerous and should be measured with great care.

- ALWAYS turn the rotary switch to the OFF when the meter is not in use.
- 'OL' appears in the display when a measurement value exceeds the range you have selected. Change to a higher range.

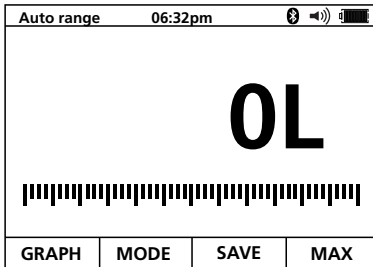

For user safety it is important to:

- Always connect the common (COM) probe first and then connect the live probe to the circuit or the instrument.
- Always remove the live probe first and then remove the common (COM) probe.

4.1 Current measurements

WARNING : To prevent possible electrical shock, fire, or personal injury:

- Never attempt to make an in-circuit current measurement when the open-circuit potential to earth is >1000 V.
- Check the instrument fuses before testing. ([Consult chapter 9. Battery and fuse replacement on page 49.](#))
- Use the proper terminals, switch position, and range for your measurement.
- Never place the probes in parallel with a circuit or component when the leads are plugged into the current terminals.

4.1.1 4 - 20 mA % measurements

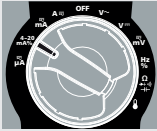
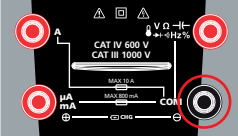
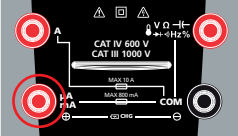
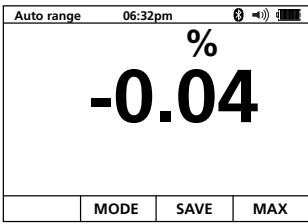
<p>1. Set the function switch to the 4-20 mA% position</p>	
<p>2. Insert the black test lead 4 mm plug into the COM terminal</p>	
<p>3. For current measurements</p> <p>3.1. up to 5000 μA DC</p> <p>3.2. up to 500 mA DC</p> <p>Insert the red test lead 4 mm plug into the μA/mA terminal</p>	
<p>4. The results will be displayed</p> <p>The meter will display loop current as a %</p> <p>0 mA = -25%</p> <p>4 mA = 0%</p> <p>20 mA = 100%</p> <p>24 mA = 125%</p>	

Operation

4.1.2 DC current measurements

CAUTION : Do not make current measurements greater than 10 A.

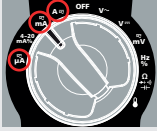
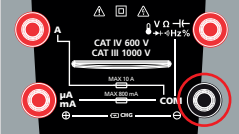
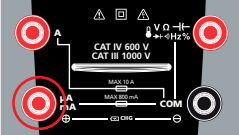
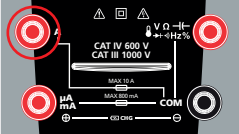
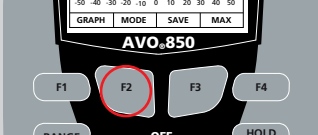
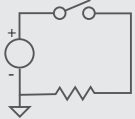
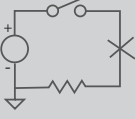
<p>1. Set the function switch. For current measurements up to:</p> <ol style="list-style-type: none">1.1. 5000 μA DC, set function switch to μA1.2. 500 mA DC, set function switch to mA1.3. 10 A Set function switch to A	
<p>2. Insert the black test lead 4 mm plug into the COM terminal</p>	
<p>3. For current measurements</p> <ol style="list-style-type: none">3.1. up to 5000 μA DC3.2. up to 500 mA DC <p>Insert the red test lead 4 mm plug into the $\mu\text{A}/\text{mA}$ terminal</p>	
<p>4. For current measurements</p> <ol style="list-style-type: none">4.1. up to 10 A DC <p>Insert the red test lead 4 mm plug into the A terminal</p>	
<p>5. Press the softkey F2 (MODE) to cycle through setting until the display shows the DC current icon (A-) in top right hand side</p>	
<p>6. Turn off the power</p>	
<p>7. Break the circuit</p>	

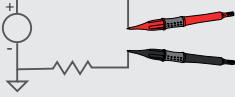
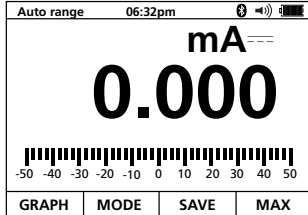
<ol style="list-style-type: none"> 8. Insert the meter probes in series with the circuit 9. Turn on the power 	
<ol style="list-style-type: none"> 10. The results will be displayed 	

4.1.3 AC current measurements

CAUTION : Do not make current measurements greater than 10 A.

Exceeding this current for grater than 30 seconds may cause damage to the meter and/or the test leads.

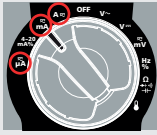
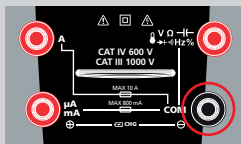
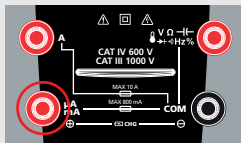
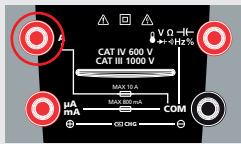
<ol style="list-style-type: none"> 1. Set the function switch to the mA position. For current measurements up to: <ol style="list-style-type: none"> 1.1. 5000 μA AC, set function switch to μA 1.2. 500 mA AC set function switch to mA 1.3. 10 A Set function switch to A 	
<ol style="list-style-type: none"> 2. Insert the black test lead 4 mm plug into the COM terminal 	
<ol style="list-style-type: none"> 3. For current measurements <ol style="list-style-type: none"> 3.1. up to 5000 μA AC 3.2. up to 500 mA AC <p>Insert the red test lead 4 mm plug into the μA/mA terminal.</p> 	
<ol style="list-style-type: none"> 4. For current measurements <ol style="list-style-type: none"> 4.1. up to 10 A AC <p>Insert the red test lead 4 mm plug into the A terminal</p> 	

Operation

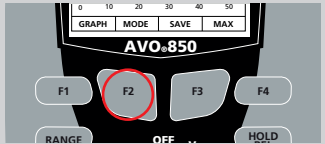
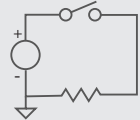
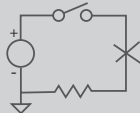
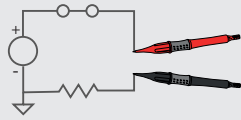
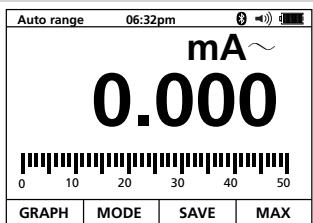
5. Press the F2 softkey (MODE) to cycle through setting until the display shows the AC current icon (A~) in top right hand side	
6. Turn off the power	
7. Break the circuit	
8. Insert the meter probes in series with the circuit 9. Turn on the power	
10. The results will be displayed	

4.2 Voltage measurement

The instrument features true RMS measurement, which gives accurate readings for distorted sine waves and other waveforms such as square waves, triangle waves, and staircase waves.

4.2.1 V AC voltage measurements

WARNING : Risk of Electrocutation.



The probe tips may not be long enough to contact the live parts inside some 240 V outlets as the contacts are recessed deep in the outlets.

This may result in the reading showing 0 V when the outlet has voltage on it.

Make sure the probe tips are touching the metal contacts inside the outlet before assuming that no voltage is present.

- Never attempt to make an in-circuit current measurement when the open circuit potential to earth is >1000 V.
- Check the Meter's fuse before testing. (Consult chapter 9.1.1 Test the fuses on page 50)
- Use the proper terminals, switch position, and range for your measurement.
- Never place the probes in parallel with a circuit or component when the leads are plugged into the A (Amps) terminal.

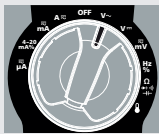
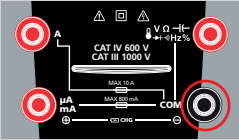
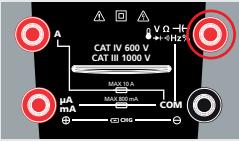
CAUTION : Do not measure AC voltages if a motor on the circuit is being switched ON or OFF, large voltage surges may occur that can damage the meter.

1. Set the switch to the V~ position	
2. Insert the black test lead 4 mm plug into the COM terminal.	
3. Insert red test lead 4 mm plug into the positive V terminal	
4. Touch the black test probe tip to the negative side of the circuit	

Operation

5. Touch the red test probe tip to the positive side of the circuit

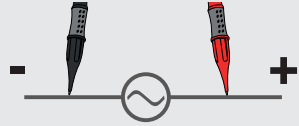

6. The results will be displayed

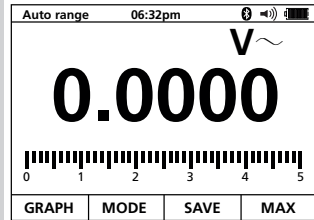

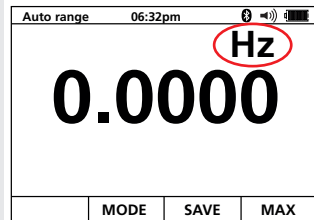

7. To display frequency and duty cycle press softkey F2 (MODE) to indicate "Hz" on the display



8. To set the unit into Low-z press softkey F2 (MODE) to indicate "Lo" icon is displayed

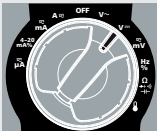
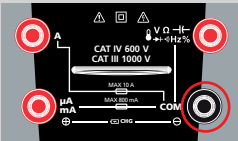
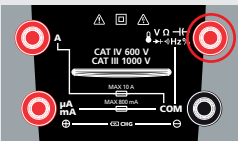

4.2.2 V DC voltage measurement

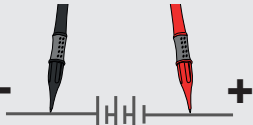
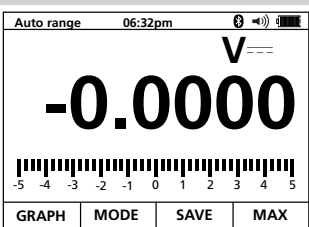
CAUTION : Do not measure DC voltages if a motor on the circuit is being switched ON or OFF, large voltage surges may occur that can damage the meter.

<p>1. Set the switch to the V DC position</p>	
<p>2. Insert the black test lead 4 mm plug into the COM terminal</p>	
<p>3. Insert the red test lead 4 mm plug into the V terminal</p>	
<p>4. Touch the black test probe tip to the negative side of the circuit</p>	
<p>5. Touch the red test probe tip to the positive side of the circuit</p>	
<p>6. The results will be displayed</p>	

Operation

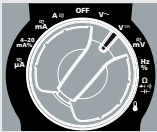
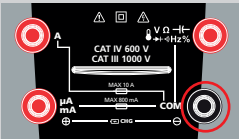
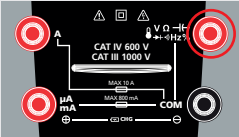
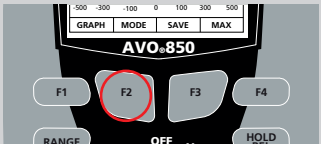
4.2.3 V AC + DC measurements

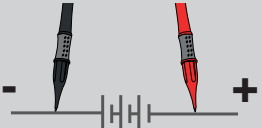
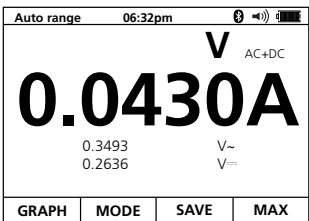
1. Set the switch to the V DC position																							
2. Insert the black test lead 4 mm plug into the COM terminal																							
3. Insert the red test lead 4 mm plug into the V terminal																							
4. Press softkey F2 (MODE) to indicate "AC+DC" on the display																							
5. Touch the black test probe tip to the negative side of the circuit																							
6. Touch the red test probe tip to the positive side of the circuit																							
7. The results will be displayed	 <table border="1" data-bbox="658 1177 967 1398"><tr><td colspan="2">Auto range</td><td colspan="2">06:32pm</td></tr><tr><td colspan="2" rowspan="2">V</td><td colspan="2">AC+DC</td></tr><tr><td colspan="2">0.0430A</td></tr><tr><td>0.3493</td><td>V~</td><td colspan="2"></td></tr><tr><td>0.2636</td><td>V-</td><td colspan="2"></td></tr><tr><td>GRAPH</td><td>MODE</td><td>SAVE</td><td>MAX</td></tr></table>	Auto range		06:32pm		V		AC+DC		0.0430A		0.3493	V~			0.2636	V-			GRAPH	MODE	SAVE	MAX
Auto range		06:32pm																					
V		AC+DC																					
		0.0430A																					
0.3493	V~																						
0.2636	V-																						
GRAPH	MODE	SAVE	MAX																				

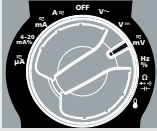
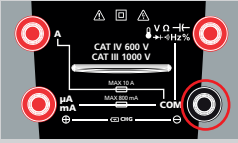
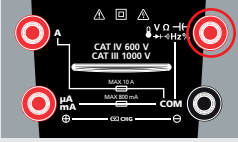
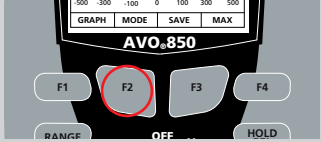
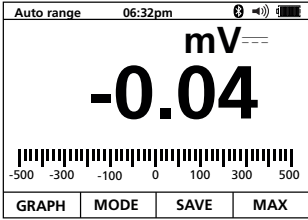

4.2.4 Milli-Volts voltage measurements

CAUTION : Do not measure AC voltages if a motor on the circuit is being switched ON or OFF, large voltage surges may occur that can damage the meter.

<p>1. Set the switch to the mV position</p>	
<p>2. Insert the black test lead 4 mm plug into the COM terminal</p>	
<p>3. Insert the red test lead 4 mm plug into the positive V terminal</p>	
<p>4. Press softkey F2 (MODE) to switch between mV DC and mV AC</p>	
<p>5. The results will be displayed</p>	

Operation

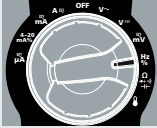
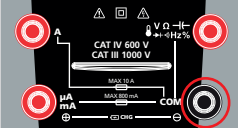
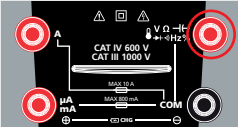

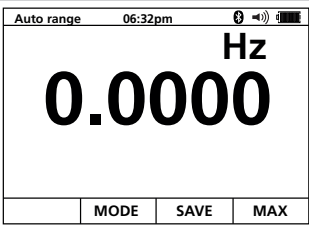
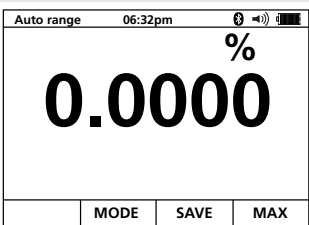
4.3 Frequency measurements

1. Set the switch to the Hz position	
2. Insert the black test lead 4 mm plug into the COM terminal	
3. Insert the red test lead 4 mm plug into the positive Hz% terminal	
4. Touch the black test probe tip to the negative side of the circuit	
5. Touch the red test probe tip to the positive side of the circuit	
6. The results will be displayed	
7. Press softkey F2 (MODE) to display duty cycle % and time	

4.4 Resistance, continuity, capacitance and diode testing

4.4.1 Resistance measurements

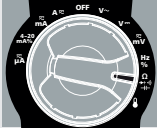
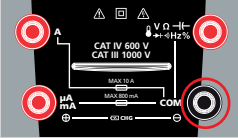
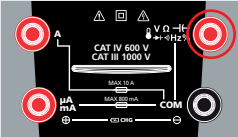
WARNING : To avoid electric shock, disconnect power to the unit under test and discharge all capacitors before taking any resistance measurements. Remove the batteries and unplug the line cords.

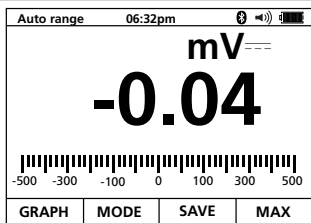
<p>1. Set the function switch to the Ω position</p>	
<p>2. Insert the black test lead 4 mm plug into the COM terminal</p>	
<p>3. Insert the red test lead 4 mm plug into the Ω terminal</p>	
<p>4. Touch the black test probe tip to the negative side of the circuit</p>	
<p>5. Touch the red test probe tip to the positive side of the circuit</p>	
<p>6. The results will be displayed</p>	



Operation

4.4.2 Continuity check

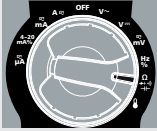
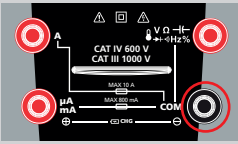
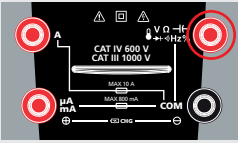
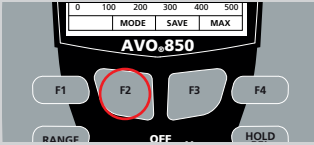
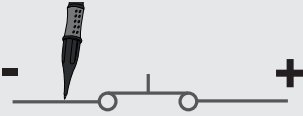
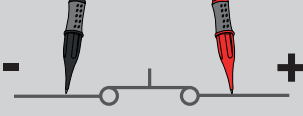
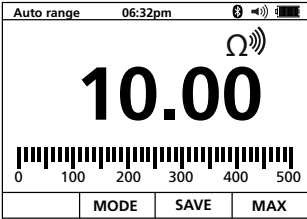
WARNING : To avoid electric shock, disconnect power to the unit under test and discharge all capacitors before taking any continuity checks. Remove the batteries and unplug the line cords.

1. Set the function switch to the continuity Ω position	
2. Insert the black test lead 4 mm plug into the COM terminal	
3. Insert the red test lead 4 mm plug into the positive continuity Ω terminal	
4. Press softkey F2 (MODE) to cycle through setting until the display shows conductance mode (Ω) in top right hand side	
5. Touch the black test probe tip to the negative side of the circuit	
6. Touch the red test probe tip to the positive side of the circuit	
7. The results will be displayed NOTE : If the resistance is less than approximately 250, the audible signal will sound. If the circuit is open, the display will indicate "OL"	

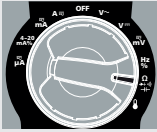
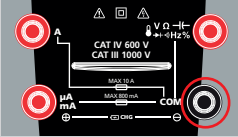
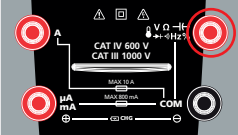
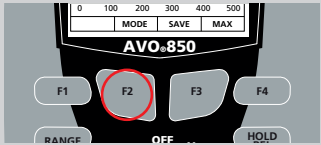
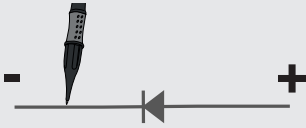

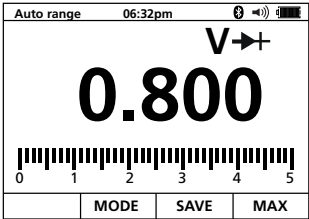
4.4.3 Diode test

<p>1. Set the function switch to the Diode position</p>	
<p>2. Insert the black test lead 4 mm plug into the COM terminal</p>	
<p>3. Insert the red test lead 4 mm plug into the positive Diode (V→) terminal</p>	
<p>4. Press softkey F2 (MODE) to cycle through setting until the display shows the Diode icon (V→) in top right hand side</p>	
<p>5. Touch the black test probe tip to the negative side of the circuit</p>	
<p>6. Touch the red test probe tip to the positive side of the circuit</p>	
<p>7. The results will be displayed</p> <p>NOTE : The voltage will typically indicate 0.400 to 3.200 V A reverse voltage will indicate "OL" Shorted devices will indicate near "OV" An open device will indicate "OL" in both polarities</p>	

Operation



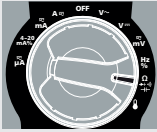
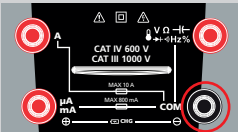
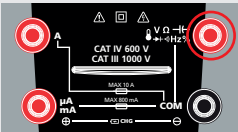
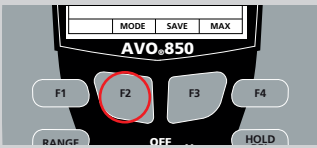
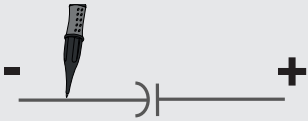

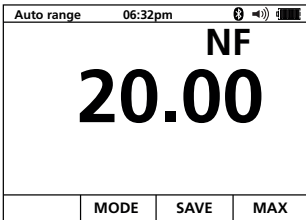
4.4.4 Capacitance measurements

WARNING : To avoid electric shock, disconnect power to the unit under test and discharge all capacitors before taking any capacitance measurements. Remove the batteries and unplug the line cords.

1. Set the function switch to the CAP position	
2. Insert the black test lead 4 mm plug into the COM terminal	
3. Insert the red test lead 4 mm plug into the positive Capacitance (— —) terminal	
4. Press softkey F2 (MODE) to cycle through setting until the display shows the capacitance icon (nF) in top right hand side	
5. Touch the black test probe tip to the negative side of the circuit	
6. Touch the red test probe tip to the positive side of the circuit	
7. The results will be displayed	

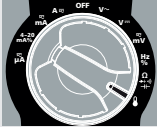
4.5 Temperature measurements

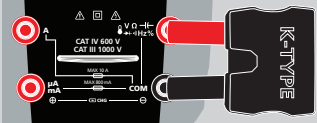
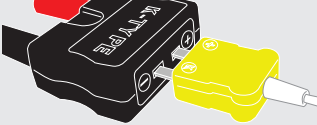
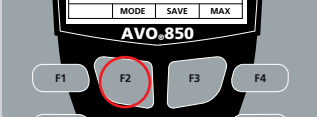
WARNING : Do not connect K-type lead to live circuits.

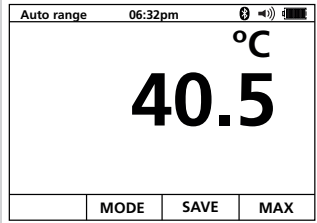
<p>1. Set the function switch to the Temperature position</p>	
<p>2. Insert the K-type adapter into the COM and Temp terminal</p> <p>NOTE : Check the black goes to COM and red TEMP</p> 	
<p>3. Connect the wire probe to the K-type adapter check making sure to observe the correct polarity + to + and - to -</p>	
<p>4. Press the softkey F2 (MODE) to change the temperature units (°C or °F), displayed in top right hand side</p>	
<p>5. Place probe tip at heat source to be measured</p>	
<p>6. The results will be displayed</p>	

5. Default display

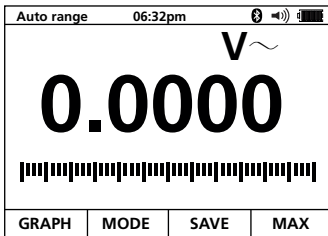

5.1 Graph measure

1. Press softkey F1 to set the meter to graph measure mode

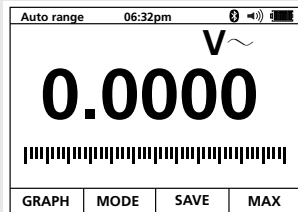

2. Press softkey F1 (START)
 - 2.1. Press softkey F2 for FAST
or
 - 2.2. Press softkey F3 for SLOW to adjust sampling rate
or
 - 2.3. Press softkey F4 (CANCEL) to exit graph display and return to normal measurement mode

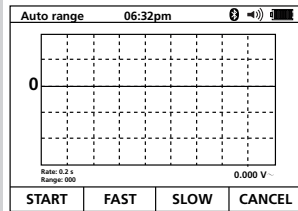

3. To stop capturing press softkey F4 (STOP)

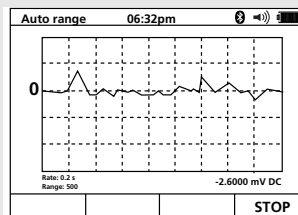

4. Data can be saved by pressing the softkey F1 (SAVE) to save the graph or
5. Press softkey F4 (BACK) to return to clear graph screen again

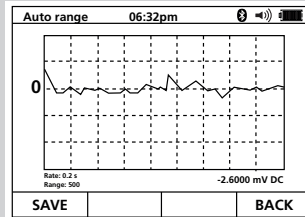

5.2 Capturing minimum and maximum values

To activate the MAXMIN mode:

1. Press softkey F4 (MAX), when the function switch one of the measurement modes.

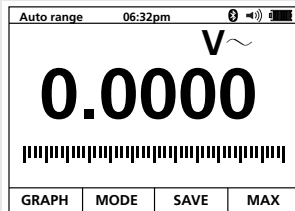

2. The meter will display and automatically start capturing the MAX, Average and Min value over time

3. To stop a MIN MAX recording session, press the softkey F2 (STOP)

The summary information in the display captures the data and holds it on the display

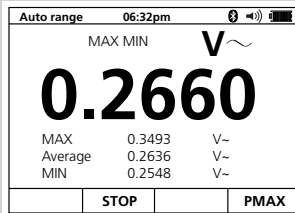

4. Press softkey F3 (SAVE) to save the collected data

5. Press softkey F4 (CLOSE) to exit the MIN MAX record session without saving the collected data

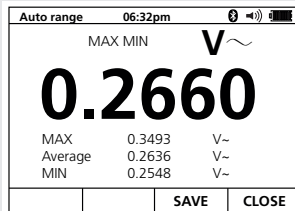

NOTE : To save the MIN MAX screen data, the MIN MAX session must be ended by pressing the softkey F1 (STOP).

Default display

5.3 Capturing peak values

To activate the peak mode, at AC measure MINMAX mode, Press softkey F4 (PMAx).

5.4 Relative values

To activate the relative mode:

1. Press the HOLD/REL button for > 1 second
2. To pause the display for any function, press HOLD/REL button
3. Press softkey F3 (SAVE) to save results to memory
4. Press close return measure

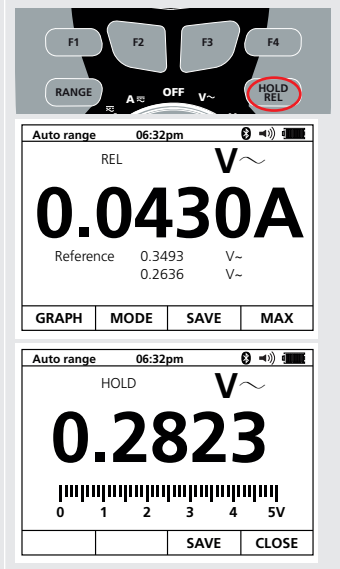

6. Save functions

When in the REL mode, press the softkey F3 (SAVE), in enter the save menu.
Then follow the next steps for each function.

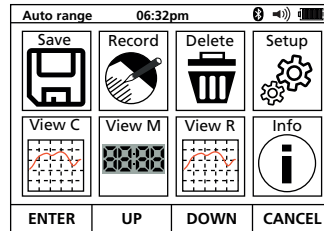
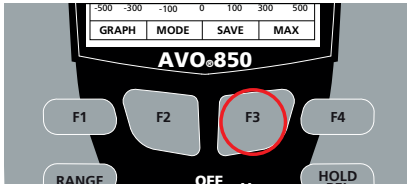

6.1 Storing individual measurement data

For common measurement functions, a snapshot of the screen data is saved.

1. Press the softkey F2 (UP) or softkey F3 (DOWN) to highlight the Save icon

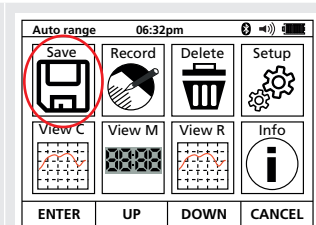

2. Press the softkey F1 (ENTER) to save the data

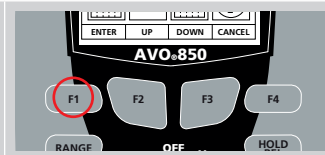

6.2 Recording measurement data

1. Press the softkey F2 (UP) or softkey F3 (DOWN) to cycle through the menu to highlight the icon on the screen labelled Record
2. Press softkey F1 (ENTER) to select

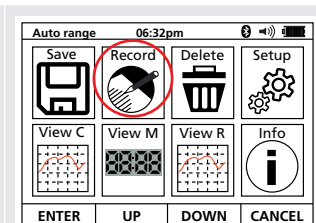

Save functions

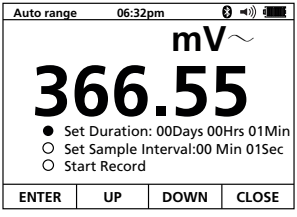
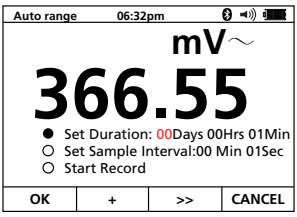
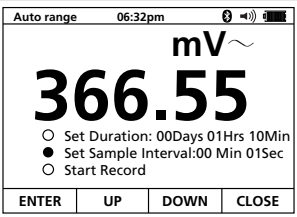
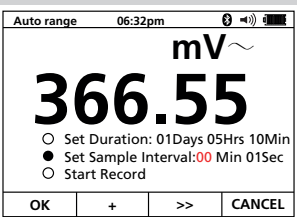
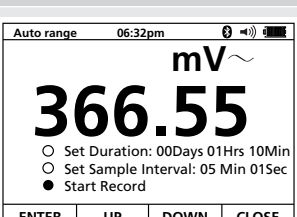
<p>3. Press the softkey F2 (UP) or softkey F3 (DOWN) to highlight the set duration option</p> <p>4. When highlighted press softkey F1 (ENTER) to start editing the duration</p>	
<p>5. Softkey F2 (+) to increase the duration when highlighted in red</p> <p>6. Softkey F3 (>>) to move along to the next value</p> <p>7. Softkey F1 (OK) to confirm or softkey F4 (CANCEL) to cancel setup</p>	
<p>8. Press the softkey F2 (UP) or softkey F3 (DOWN) to highlight the set sample interval:</p>	
<p>8.1. Press softkey F2 (+) to increase the interval minutes and seconds when highlighted in red</p> <p>8.2. Press softkey F3 (>>) to move along to the next value</p> <p>8.3. Press softkey F1 (OK) to confirm or softkey F4 (CANCEL) to cancel setup</p>	
<p>9. Press the softkey F2 (UP) or softkey F3 (DOWN) to highlight the Start recording</p> <p>10. Press the softkey F1(ENTER) when ready to start the recording or F4 (CLOSE) to cancel and exit</p>	
<p>NOTE : The session will continue until the allocated memory is used, the batteries expire, the function switch is moved, or the session is terminated by pressing the softkey F4 (STOP)</p>	

11. To save the data press the softkey F2 (SAVE) at the end of the duration or after stopping the recording early
12. To exit without saving press softkey F4 (CLOSE)

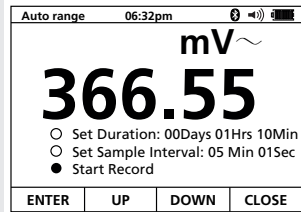

6.3 Delete

1. Press the softkey F2 (UP) or softkey F3 (DOWN) to cycle through the menu to highlight the icon on the screen labelled Delete.
2. Press softkey F1 (ENTER) to select.

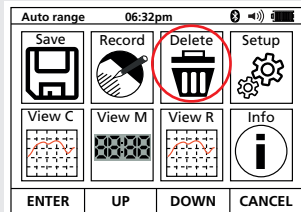

3. Press the softkey F2 (UP) or softkey F3 (DOWN) to highlight the option required:
 - 3.1. Delete all measurements – Removes all saved measurements
 - 3.2. Delete all records – Remove data logged data saved on the unit
 - 3.3. Delete all graphs – Removes all saved graphs

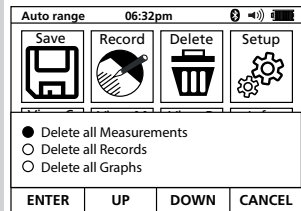

4. Softkey F1 (OK) to delete the data you have selected
5. Softkey F1 (OK) to confirm or softkey F4 (CANCEL) to cancel

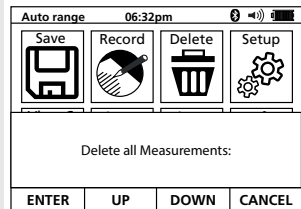

6.4 Viewing graph data

1. Press the softkey F2 (UP) or softkey F3 (DOWN) to cycle through the menu to highlight the icon on the screen labelled Graph
2. Press softkey F1 (ENTER)

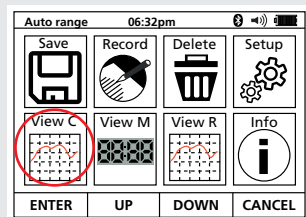

3. Press the softkey F2 (PREV) and softkey F3 (NEXT) to move between switch between stored graph data
4. Press softkey F1 (ENTER) to view graph data in more detail

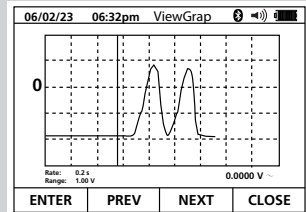

5. Press the softkey F2 (<<) and softkey F3 (>>) to move the cursor to data point of interest

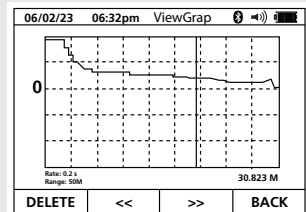

6.5 Data recall

1. Press the softkey F2 (UP) or softkey F3 (DOWN) to cycle through the menu to highlight the icon on the screen labelled View M

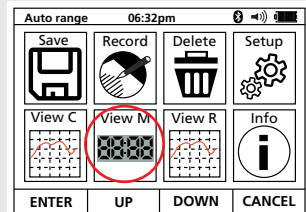

2. Press the softkey F1 (ENTER) to view the stored data

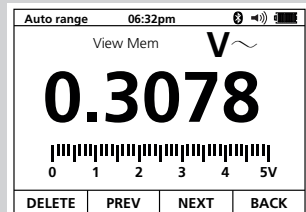

6.6 Viewing trend data

1. Press the softkey F2 (UP) or softkey F3 (DOWN) to cycle through the menu to highlight the icon on the screen labelled View R
 - 1.1. Press the softkey F1 (ENTER) to view the recorded data

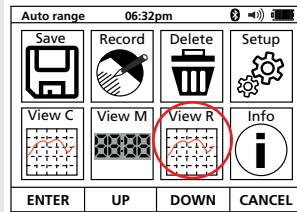

2. Press the softkey F1 (TREND)

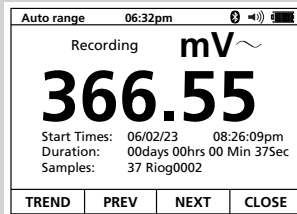

3. Press the softkey F2 (+) to increase Graph resolution
4. Press the softkey F3 (>>) to move the move cursor along the data points
5. Press the softkey F1 (DELETE) to delete the data
6. Press the softkey F4 (BACK) to move the move cursor along the data points

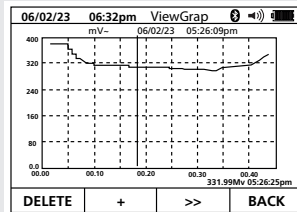

6.7 Info

1. Press the softkey F2 (UP) or softkey F3 (DOWN) to cycle through the menu to highlight the icon on the screen labelled info
2. Press softkey F1 (ENTER) to select
3. To scroll the information, press the softkey F2 (UP) or softkey F3 (DOWN) to scroll up or down the page
4. To close press softkey F4 (CLOSE)

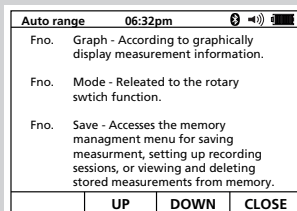
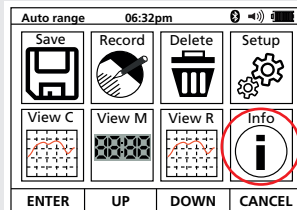

7. Setup options

The instrument set up menu is accessed via the save menu at any time.

1. Press the softkey F3 (SAVE), to enter the save menu

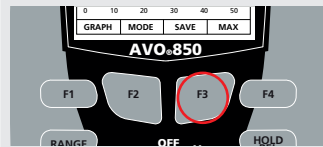

2. Press the softkey F2 (UP) or softkey F3 (DOWN) to cycle through the menu to highlight the icon on the screen labelled Setup

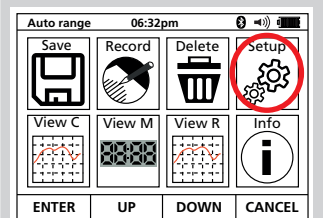

3. Press the softkey F1 (ENTER) to open the list

4. Press the softkey F2 (UP) or softkey F3 (DOWN) to move through the list and highlight the setting required

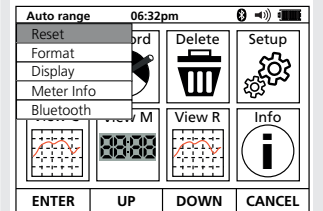

5. Press the softkey F1 (ENTER) to select

Then follow the next steps for each function

7.1 Factory reset

Resets the instrument to default values:

1. Press the softkey F2 (UP) or softkey F3 (DOWN) to highlight Reset
2. Press the softkey F1 (ENTER) to open the list

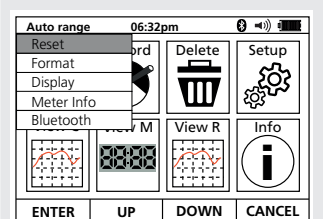

3. A message will display ok to confirm
 - 3.1. Press the softkey F2 (OK) to confirm
 - 3.1. Press softkey F4 (Cancel) to cancel factory resetting the meter.

NOTE : Calibrate is intended for service and repairs from authorised for Megger Instruments distributor or repair centre's. [Consult chapter 11. Calibration, repair and warranty on page 57](#)

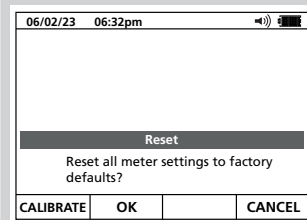

7.2 Format

The format options sets the beeper and digital formats.

1. Press the softkey F2 (UP) or F3 (DOWN) to highlight Format
2. Press the softkey F1 (ENTER) to open the list

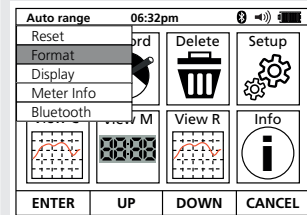

7.2.1 Beeper On/Off

The unit can be configured to have a beeper sound on button presses and alerts.

1. Press the softkey F2 (UP) or softkey F3 (DOWN) to navigate to the option on the screen labelled Beeper
2. Press the softkey F1 (EDIT)

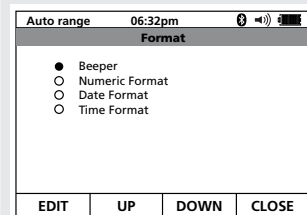

3. Turn the meters beeper on or off:
 - 3.1. Press softkey F1 (ON) to enable
 - 3.2. Press softkey F2 (OFF) to disable the beeper
 - 3.3. Press softkey F4 (CLOSE) to exit

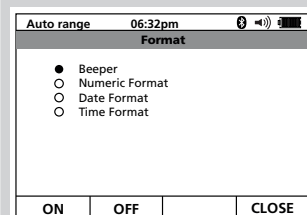

Setup options

7.2.2 Numeric format

The symbol for the decimal marker can be changed to be either the point on the line or the comma on the line to change the setting on the meter:

1. Press the softkey F2 (UP) or softkey F3 (DOWN) to navigate to the option on the screen labelled Numeric Format
2. Press the softkey F1 (EDIT):

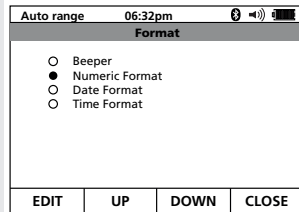

- 2.1. Press softkey F1 (0.00) for decimal point
- 2.2. Press softkey F2 (0,00) for comma.
- 2.3. To cancel and not make any changes press softkey F4 (CANCEL)

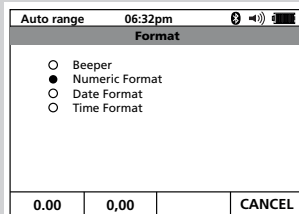

7.2.3 Setting date format

1. Press the softkey F2 (UP) or softkey F3 (DOWN) to navigate to the option on the screen labelled Date Format
2. Press the softkey F1 (EDIT):

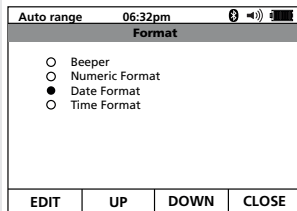

- 2.1. Press softkey F1 (MM/DD/YY)
- 2.2. Press softkey F2 (DD/MM/YY).
- 2.3. To cancel and not make any changes press softkey F4 (CANCEL)

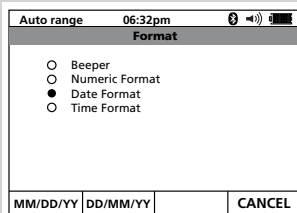

7.2.4 Setting time format

1. Press the softkey F2 (UP) or softkey F3 (DOWN) to cycle through to the option on the screen labelled: Time Format
2. Press the softkey F1 (EDIT):

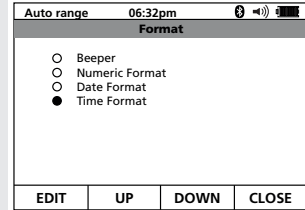

2.1. Press softkey F1 (24 hour)

2.2. Press softkey F2 (12 hour)

2.3. To cancel and not make any changes press softkey F4 (CANCEL)

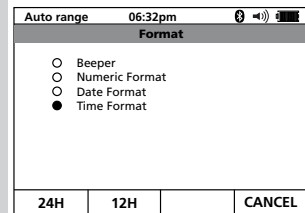

7.3 Display settings

The display options sets the date, time, Auto power off, display foreground/background colour and font style.

1. Press the softkey F2 (UP) or softkey F3 (DOWN) to highlight Display
2. Press the softkey F1 (ENTER) to open the list

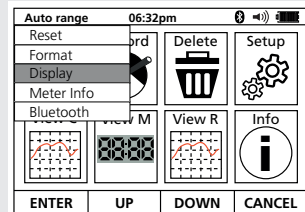

Setup options

7.3.1 Setting date and time

1. Press the softkey F2 (UP) or softkey F3 (DOWN) to navigate to Set Date

2. Press the softkey F1 (EDIT)

This will highlight the first value to be changed:

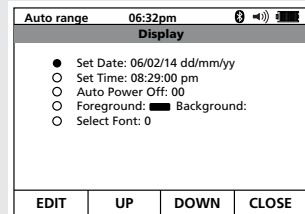

2.1. Using the softkey F2 (+) will increase the value

2.1. Press softkey F3 (>>) to move on to the next value

2.1. When done softkey F1 (OK) to confirm the values when done

2.1. To cancel and not make any changes press softkey F4 (CANCEL)

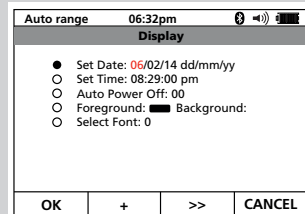

3. Press the softkey F2 (UP) or F3 (DOWN) to navigate to Set Time

4. Press the softkey F1 (EDIT):

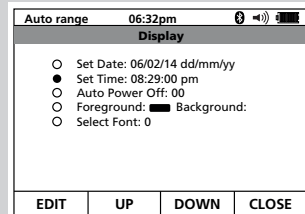

4.1. Using the softkey F2 (+) will increase the value

4.2. Press softkey F3 (>>) to move on to the next value

4.3. When done softkey F1 (OK) to confirm the values when done

4.4. To cancel and not make any changes press softkey F4 (CANCEL)

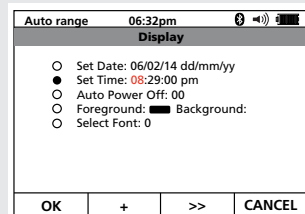

7.3.2 Battery saver auto power off (APO)

(APO) Sleep mode activates and the display goes blank if there is no activity for 20 minutes (factory default), to save battery life.

To wake the instrument up, turn the rotary switch to the off position and back to the desired mode. To disable or change the APO duration:

1. Press the softkey F2 (UP) or softkey F3 (DOWN) to navigate to Auto Power Off
2. Press the softkey F1 (EDIT):

Auto range	06:32pm		
Display			
<input type="radio"/> Set Date: 06/02/14 dd/mm/yy <input type="radio"/> Set Time: 08:29:00 pm <input checked="" type="radio"/> Auto Power Off: 00 <input type="radio"/> Foreground: Background: <input type="radio"/> Select Font: 0			
EDIT	UP	DOWN	CLOSE

- 2.1. Using the softkey F2 (UP) will increase the value
- 2.2. Press softkey F3 (DOWN) to move on to the next value.
- 2.3. When done softkey F1 (OK) to confirm the values when done
- 2.4. To cancel and not make any changes press softkey F4 (CANCEL)

Auto range	06:32pm		
Display			
<input type="radio"/> Set Date: 06/02/14 dd/mm/yy <input type="radio"/> Set Time: 08:29:00 pm <input checked="" type="radio"/> Auto Power Off: 00 <input type="radio"/> Foreground: Background: <input type="radio"/> Select Font: 0			
OK	UP	DOWN	CANCEL

NOTE : The APO is NOT disabled in the MIN MAX AVG mode.

7.3.3 Foreground and background

1. Press the softkey F2 (UP) or softkey F3 (DOWN) to navigate to Foreground.
2. Press the softkey F1 (EDIT):

Auto range	06:32pm		
Display			
<input type="radio"/> Set Date: 06/02/14 dd/mm/yy <input type="radio"/> Set Time: 08:29:00 pm <input type="radio"/> Auto Power Off: 00 <input checked="" type="radio"/> Foreground: Background: <input type="radio"/> Select Font: 0			
EDIT	UP	DOWN	CLOSE

3. Using the softkey F2 (UP) or softkey F3 (DOWN) to cycle through the different colour settings available
 - 3.1. When done softkey F1 (OK) to confirm the values when done
 - 3.2. To cancel and not make any changes press softkey F4 (CANCEL)

Auto range	06:32pm		
Display			
<input type="radio"/> Set Date: 06/02/14 dd/mm/yy <input type="radio"/> Set Time: 08:29:00 pm <input type="radio"/> Auto Power Off: 00 <input checked="" type="radio"/> Foreground: Background: <input type="radio"/> Select Font: 0			
OK	UP	DOWN	CLOSE

Setup options

7.3.4 Set font

1. Press the softkey F2 (UP) or softkey F3 (DOWN) to cycle through to the option on the screen labelled highlight select font
2. Press the softkey F1 (EDIT):

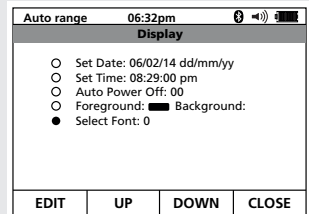

3. Using the softkey F2 (UP) or F3 (DOWN) to cycle through the different font settings available
 - 3.1. When done F1 (OK) to confirm the values when done
 - 3.2. To cancel and not make any changes press softkey F4 (CANCEL)

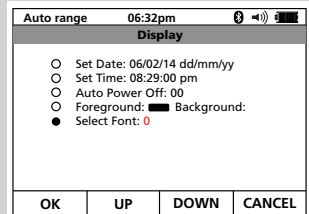

7.4 Meter info

This selection lists the serial number, and firmware version.

1. Press the softkey F2 (UP) or softkey F3 (DOWN) to highlight Meter Info
2. Press the softkey F1 (ENTER) to open the list

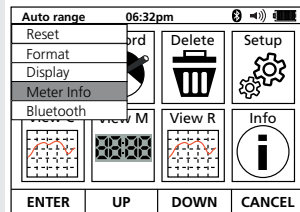

3. The display will show the is serial number and firmware version

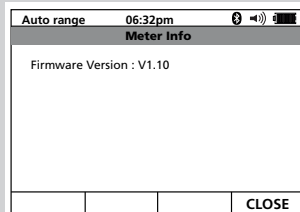

7.5 Bluetooth

The Bluetooth communication link can transfer the data from the instrument memory to a phone, tablet or PC.

1. Press the softkey F2 (UP) or softkey F3 (DOWN) to navigate to Bluetooth
2. Press the softkey F1 (ENTER)

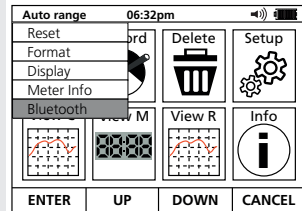

3. If Bluetooth is turned OFF the display will display message "Turn on Bluetooth?"
 - 3.1. Press softkey F1 (OK) to turn on
 - 3.1. Press softkey F4 (Cancel) to cancel and not change.

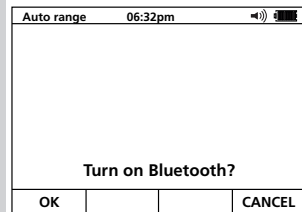

4. If Bluetooth is turned ON the display will display message "Turn OFF Bluetooth?"
 - 4.1. Press softkey F1 (OK) to turn off
 - 4.1. Press softkey F4 (Cancel) to cancel and not change

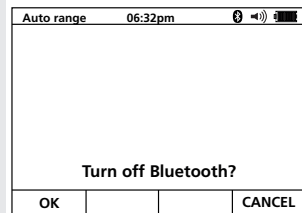

To download the Magger AVO Link App click or scan the QR code below:



8. Maintenance

NOTE : There are no user replaceable parts within this multimeter, other than the rechargeable battery and the fuses.

8.1 General maintenance

Ensure the unit is kept clean and dry after use.

Close all covers when not in use.

Test leads and adaptors should be checked before use for damage and continuity.

8.2 Cleaning

Disconnect from mains power / charger.

Switch off and remove battery cells.

Wipe the instrument with a clean cloth dampened with either water or isopropyl alcohol (IPA).

8.3 Battery

WARNING : Always set the instrument to OFF before battery cells are removed or installed.

CAUTION : Old batteries must be disposed of in accordance with local regulations.

CAUTION : Only use approved batteries as defined below.

Battery (and fuses) are user-accessible using a screwdriver to remove access covers to the left of the grip (and to the right of the barrel respectively).

To help maintain the health, reliability and longevity of the installed batteries:

Remove battery cells if the instrument is not going to be used for a long period.

Store batteries in a cool, dry place. Batteries can be damaged when exposed to heat.

8.3.1 Battery status

WARNING : Do not recharge Alkaline batteries.

Battery condition icon is positioned at the top right hand corner of display. This icon is displayed at all times when the instrument is switched on. When running the icon will indicate state of charge, the icon will be filled in proportion to the state of charge.

8.4 Maintenance

WARNING : To prevent possible electrical shock, fire, personal injury, or damage to the multimeter:

- Repair the instrument before use if the battery leaks.
- Do not operate the instrument with covers removed or the case open. Hazardous voltage exposure is possible.
- Remove the input test leads before you clean the instrument.
- Use only specified replacement parts.
- Have an approved technician repair the instrument.
- Use only specified replacement fuses.
- Replace a blown fuse with exact replacement only for continued protection against arc flash.

9. Battery and fuse replacement

WARNING : Switch off the instrument and remove any connection before removing the battery cover.

CAUTION : Batteries should not be left in the instrument if remaining unused for an extended period.

The battery pack is user-accessible using a screwdriver or penny to undo the latch then open the access cover.

Fuses are user-accessible using a screwdriver or penny to undo the latch then open the access cover.

9.1 Replacing the battery and fuses

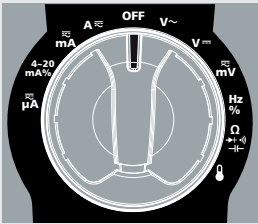
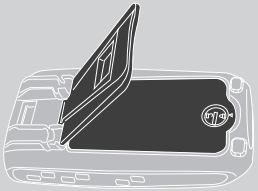
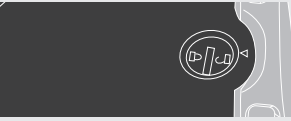
Description	Model Number
10 A 1000 V 30 kA Fast Acting Ultra Rapid Ceramic Fuse	50 199 06/10A
800 mA 1000 V 30 kA Fast Acting Ultra Rapid Ceramic Fuse	70-172-40/0.8A
<ol style="list-style-type: none"> Turn the multimeter off and remove the test leads from the terminals 	
<ol style="list-style-type: none"> Extend the tilt stand to expose the battery door 	
<ol style="list-style-type: none"> Turn the battery-door latch until the unlock symbol aligns with the arrow 	

Battery and fuse replacement

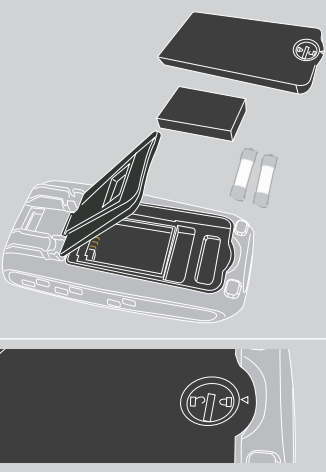
4. Lift the fuse/battery cover off of the instrument	
5. Remove the fuse. Use correct tool to avoid damaging components inside	
5.1. For the 800 mA fuse lift the plastic cover off the fuse first	
6. Use ONLY fuses with the amperage, interrupt, voltage, and speed rating specified	
7. If replacing the 800 mA fuse the plastic cover MUST be fitted back in place first	
8. To fit the fuse/battery cover back on	
9. Turn the battery-door latch until the lock symbol aligns with the arrow	

9.1.1 Test the fuses

Test fuses as shown below.

800 mA fuse	10 A fuse
800 mA $<200 \Omega$ = OK	10 A $< 2 \Omega$ = OK
800 mA OL = Fuse not OK	10 A OL = Fuse not OK

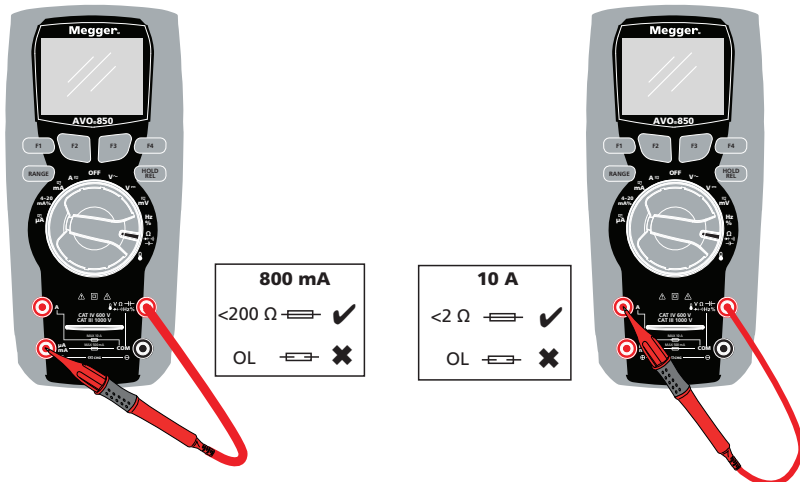

9.2 Li-ion battery charge

Item	Description	Model Number
Lithium polymer battery	NEDA 1604 battery 1200 mAh 7.4 V 8.88 Wh	PT603450-2S

1. Turn the instrument off and remove the test leads from the terminals

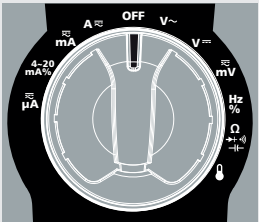

2. Insert the socket into the instruments Input ports and the adapter connected to the switch socket



3. Then Insert the adapter into power supply
A charge symbol will display

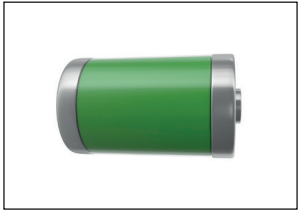

Specifications

10. Specifications

Accuracy is specified for 1 year after calibration, at operating temperatures of 18 °C to 28 °C, with relative humidity at 0 % to 90 %. Accuracy specifications take the form of: (±(% of Reading) + (Counts))

Specification	Detail
Maximum voltage between any terminal and earth ground	1000 V
F1 Fuse protection for A inputs	10 A, 1000 V, 30 kA
F2 Fuse protection for mA input	800 mA, 1000 V, 30 kA
Battery	Lithium polymer battery (NEDA 1604 battery 1200 mAh 7.4 V 8.88 Wh)
Display	50 000 count, TFT LCD 20x per second
Altitude	2000 m maximum
Operating temperature	5 °C to +40 °C (41 °F to 104 °F)
Storage temperature	-20 °C to +60 °C (-4 °F to 140 °F)
Operating humidity	Max 80% up to 31 °C (87 °F) decreasing linearly to 50% at 40 °C (104 °F)
Storage humidity	50% at 40 °C (104 °F)
Battery life	Lithium polymer battery 300 to 500 charge cycles
Size (H x W x D)	170 mm x 79 mm x 50 mm
Weight	376 g with battery 416 g
Safety	IEC 61010-1: Pollution Degree 2 IEC 61010-2-033: CAT IV 600 V, CAT III 1000 V
EMC	IEC 61326-1: Portable Electromagnetic Environment, CISPR 11: Group 1, Class A, IEC 61326-2-2
Enclosure	Double moulded, IP40 rating
Shock (drop test)	2 m (6.5 ft)
Continuity check	Audible signal will sound if the resistance is less than 250 (approx.), test current <0.35 mA
Diode test	Test current of 1.5 mA maximum, open circuit voltage 3.2 V DC typical
PEAK	Captures peaks > 1 ms
Temperature sensor	Requires K-type thermocouple
Input impedance	> 10 MΩ V DC and >9 MΩ V AC
AC response	True RMS
AC True RMS	The term stands for "Root-Mean-Square," which represents the method of calculation of the voltage or current value. Average responding multimeters are calibrated to read correctly only on sine waves, and they will read inaccurately on non-sine wave or distorted signals. True rms meters read accurately on either type of signal

Specification	Detail
ACV bandwidth	50 Hz to 20 000 Hz
Overrange indication	OL is displayed
Auto Power OFF	5-30 minutes (approximately) with disable feature
Polarity	Automatic (no indication for positive); Minus (-) sign for negative
Low battery indication	 " " is displayed if battery voltage drops below voltage.

10.1 Electrical specifications

10.1.1 AC voltage

Range	Resolution	50/60 Hz	<1 kHz	<5 kHz	<20 kHz*
500 mV	0.01 mV	(±0.5% +5)	(±1.0% +5)	(±3.0% +5)	(±5.5% +20)
5 V	0.0001 V				
50 V	0.001 V		(±1.5% +10)	(±3.5% +10)	unspecified
500 V	0.01 V			unspecified	unspecified
1000 V	0.1 V				

* upper 10 % of range.

10.1.2 DC voltage

Range	Resolution	Accuracy
500 mV *	0.01 mV	(±0.1% + 5 digits)
5 V	0.0001 V	(±0.05% + 5 digits)
50 V	0.001 V	(±0.05% + 5 digits)
500 V	0.01 V	(±0.05% + 5 digits)
1000 V	0.1 V	(±0.1% + 5 digits)

* When using the relative mode (REL Q) to compensate for offsets.

10.1.3 (AC+DC)

Range	Resolution	<1 kHz	<5 kHz
5 V	0.0001 V	(±1.2% + 20)	(±3.0% + 20)
50 V	0.001 V		
500 V	0.01 V		
1000 V	0.1 V		

Specifications

10.1.4 Resistance

Range	Resolution	Accuracy
500 Ω *	0.01 Ω	(±0.20% +10)
5 kΩ	0.0001 kΩ	(±0.20% +5)
50 kΩ	0.001 kΩ	(±0.20% +5)
500 kΩ	0.01 kΩ	(±0.50% +5)
5 MΩ	0.0001 MΩ	(±0.50% +5)
50 MΩ	0.001 MΩ	(±2.0% +10)

*When using the relative mode (REL Q) to compensate for offsets

10.1.5 Temp (type-K)

Range	Resolution	Accuracy
-200 to 1350 °C	0.1 °C	(±1.0% reading + 3.0 °C) (±1.0% reading +5.4 °F) (probe accuracy not included)
1. Does not include error of the thermocouple probe.		
2. Accuracy specification assumes ambient temperature stable to ± 1 °C.		
3. Use a long time, reading will increase 2 °C.		
4. <-50 °C Temp Rang accuracy (±3% + 5 °C)		

10.1.6 DC current

Range	Resolution	Accuracy
500 µA	0.01 µA	(±0.2% + 5)
5000 µA	0.1 µA	(±0.2% + 5)
50 mA	0.001 mA	(±0.2% + 5)
500 mA	0.01 mA	(±0.3% + 8)
10 A	0.001 A	(±0.5% + 8)

10.1.7 AC current

Range	Resolution	Accuracy	
		< 1 kHz	< 5 kHz
500 µA	0.01 µA	(±0.8% +5)	(±3% + 5)
5000 µA	0.1 µA		
50 mA	0.001 mA		
500 mA	0.01 mA		
10 A	0.001 A		
All AC current ranges are specified from 5% of range to 100% of range Amps input burden voltage (typical): mA input ~3.8 mV/A, A input ~30 mV/A.			

10.1.8 Capacitance

Range	Resolution	Accuracy
5 nF *	0.001 nF	($\pm 1.5\% + 20$)
50 nF	0.01 nF	($\pm 1.5\% + 8$)
500 nF	0.1 nF	($\pm 1.0\% + 8$)
5 μ F	0.001 μ F	($\pm 1.5\% + 8$)
50 μ F	0.01 μ F	($\pm 1.0\% + 8$)
500 μ F	0.1 μ F	($\pm 1.5\% + 8$)
10 mF	0.01 mF	($\pm 2.5\% + 20$)

* With a film capacitor or better, using relative mode (REL) to zero residual

10.1.9 Electronic frequency

Range	Resolution	Accuracy
50 Hz	0.001 Hz	($\pm 0.05\% + 5$)
500 Hz	0.01 Hz	($\pm 0.01\% + 5$)
5 kHz	0.0001 kHz	($\pm 0.01\% + 5$)
50 kHz	0.001 kHz	($\pm 0.01\% + 5$)
500 kHz	0.01 kHz	($\pm 0.01\% + 5$)
5 MHz	0.0001 MHz	($\pm 0.01\% + 5$)
10 MHz	0.001 MHz	unspecified

Sensitivity: 2 V rms min. @ 20% to 80% duty cycle and <100 kHz; 5 V rms min @ 20% to 80% duty cycle and >100 kHz.

10.1.10 Electrical frequency

Range	Resolution	Accuracy
10.00 Hz – 10 kHz	0.01 Hz - 0.001 kHz	($\pm 0.5\%$ reading)

Sensitivity: 2 V rms

10.1.11 Duty cycle

Range	Resolution	Accuracy
0.1 to 99.90%	0.01%	($\pm 1.2\%$ reading + 2 digits)

Pulse width: 100 μ s – 100 ms,
Frequency: 5 Hz to 150 kHz

10.2 Safety

This instrument is intended for origin of installation use and are protected by double insulation per 61010-1:2010 +A1:2019 Safety requirements for electrical equipment for measurement, control, and laboratory use to Measurement connection: CAT III 1,000 V and CAT IV 600 V; Pollution Degree 2.

The instrument also meets EN (IEC) 61010-2-033:2021 +A11:2021, particular requirements for hand-held multimeters and other meters, 61010-031:2015, Safety requirements for hand-held probe assemblies for electrical measurement and test, EN 62479: 2010 Assessment of the compliance of low power electronic and electrical equipment with the basic restrictions related to human exposure to electromagnetic fields (10 MHz to 300 GHz); and EN 50663: 2017 Generic standard for assessment of low power electronic and electrical equipment related to human exposure restrictions for electromagnetic fields (10 MHz - 300 GHz).

11. Calibration, repair and warranty

11.1 Limited warranty

This Megger product will be free from defects in material and workmanship for three years from the date of purchase. This warranty does not cover fuses, disposable batteries, or damage from accident, neglect, misuse, alteration, contamination, or abnormal conditions of operation or handling.

11.2 Repair and warranty

This Megger product contains static sensitive devices, and care must be taken in handling the printed circuit board. If an instrument's protection has been impaired, it should not be used but sent for repair by suitably trained and qualified personnel. The protection is likely to be impaired if for example, it shows visible damage; fails to perform the intended measurements; has been subjected to prolonged storage under unfavourable conditions or has been subjected to severe transport stresses.

NOTE : Any unauthorised prior repair or adjustment will automatically invalidate the warranty.

11.3 Instrument repair and spare parts

For service requirements contact Megger instruments or an approved repair company.

Megger Limited

Archcliffe Road

Dover

Kent

CT17 9EN

U.K.

Tel: +44 (0) 1304 502 243

Fax: +44 (0) 1304 207 342

11.4 Returning and instrument for repair

WARNING : Remove the battery cells before shipping this instrument.

If it is necessary to return an instrument for repair, a Returns Authorisation number must first be obtained by contacting one of the addresses shown. You will be asked to provide key information, such as the instrument serial number and fault reported when the number is issued. This will enable the Service Department to prepare in advance for the receipt of your instrument, and to provide the best possible service to you. The Returns Authorisation number should be clearly marked on the outside of the product packaging, and on any related correspondence. The instrument should be sent, freight paid to the appropriate address. If appropriate a copies of the original purchase invoice and of the packing note, should be sent simultaneously by airmail to expedite clearance through customs. For instruments requiring repair outside the warranty period a repair estimate will be submitted to the sender, if required, before work on the instrument commences. Approved Repair Companies A number of independent instrument repair companies have been authorised for repair work on most Megger instruments, using genuine Megger spare parts. A list of approved companies is available from the UK address shown.

11.5 Calibration, service and spare parts

For service requirements for Megger Instruments contact **Megger** or your local distributor or authorised repair centre.

Megger operates fully traceable calibration and repair facilities, to make sure your instrument continues to provide the high standard of performance and workmanship you expect. These facilities are complemented by a worldwide network of approved repair and calibration companies to offer excellent in-service care for your Megger products.

See the **last page** of this User Guide for Megger contact details.

To find your local Authorised Service Centre email Megger on **ukrepairs@megger.com** and give details of your location.

11.6 Approved repair companies

A number of independent instrument repair companies have been approved to do repair work on most Megger instruments, complete with genuine Megger spare parts.

Consult the Appointed Distributor / Agent about spare parts, repair facilities and advice.

12. Decommissioning

12.1 WEEE Directive



The crossed out wheeled bin symbol placed on Megger products is a reminder not to dispose of the product at the end of its life with general waste.

Megger is registered in the UK as a Producer of Electrical and Electronic Equipment. The Registration No is WEE/ HE0146QT.

For further information about disposal of the product consult your local Megger company or distributor or visit your local Megger website.

12.2 Battery disposal

The crossed out wheeled bin symbol placed on a battery is a reminder not to dispose of batteries with general waste when they reach the end of their usable life.

For disposal of batteries in other parts of the EU contact your local Megger branch or distributor.

Megger is registered in the UK as a producer of batteries (registration No.: BPRN00142).

For further information see www.megger.com

13. Worldwide sales offices

Sales Office	Telephone	Email
UK	T. +44 (0)1 304 502101	E. UKsales@megger.com
USA – Dallas	T. +1 214 333 3201	E. USsales@megger.com
USA – Valley Forge	T. +1 214 333 3201	E. USsales@megger.com
USA – Dallas	T. +1 214 333 3201	E. USsales@megger.com
DEUTSCHLAND – Aachen	T. +49 (0) 241 91380 500	E. info@megger.de
SVERIGE	T. +46 08 510 195 00	E. seinfo@megger.com
中国	T. +86 512 6556 7262	E. meggerchina@megger.com
中国 - 香港	T. +852 26189964	E. meggerchina@megger.com
ČESKÁ REPUBLIKA	T. +420 222 520 508	E. info.cz@megger.com
América Latina	T. +1 214 330 3293	E. csasales@megger.com
ESPAÑA	T. +34 916 16 54 96	E. info.es@megger.com
SUOMI	T. +358 08 510 195 00	E. seinfo@megger.com
FRANCE	T. +01 30 16 08 90	E. infos@megger.com
ΕΛΛΑΔΑ	T. +49 (0) 9544 68 0	E. sales@sebakmt.com
Magyarország	T. +36 1 214-2512	E. info@megger.hu
ITALIA	T. +49 (0) 9544 68 0	E. sales@sebakmt.com
日本	T. +44 (0)1 304 502101	E. UKsales@megger.com
한국	T. +1-800-723-2861	E. sales@megger.com
العربية الرياض	T. +966 55 111 6836	E. MESales@megger.com
مملكة البحرين	T. +973 17440620	E. MESales@megger.com
NEDERLAND	T. +46 08 510 195 00	E. seinfo@megger.com
NORGE	T. +46 08 510 195 00	E. seinfo@megger.com
POLSKA	T. +48 22 2809 808	E. info.pl@megger.com
PORTUGAL	T. +34 916 16 54 96	E. info.es@megger.com
ROMÂNIA	T. +40 21 2309138	E. info.ro@megger.com
РОССИЯ	T. +7 495 2 34 91 61	E. sebaso@sebaspectrum.ru
SLOVENSKO	T. +421 2 554 23 958	E. info.sk@megger.com
TÜRKIYE	T. +46 08 510 195 00	E. seinfo@megger.com



Local Sales office

Megger Limited
Archcliffe Road
Dover
Kent
CT17 9EN
ENGLAND
T. +44 (0)1 304 502101
F. +44 (0)1 304 207342

Manufacturing sites

Megger Limited
Dover, ENGLAND
T. +44 (0)1 304 502101
E. uksales@megger.com

Megger AB
Danderyd, SWEDEN
T. +46 08 510 195 00
E. seinfo@megger.com

Megger Valley Forge
Phoenixville, PA USA
T. +1 610 676 8500
E. USsales@megger.com

Megger USA - Dallas
Dallas, TX USA
T. +1 214 333 3201
E. USsales@megger.com

Megger USA - Fort Collins
Fort Collins, CO USA
T. +1 970 282 1200

Megger GmbH
Aachen, GERMANY
T. +49 (0) 241 91380 500
E. info@megger.de

Megger Germany GmbH
Baunach, GERMANY
T. +49 (0) 9544 68 - 0
E. baunach@megger.com

Megger Germany GmbH
Radeburg, GERMANY
T. +49 (0) 35208 84-0
E. radeburg@megger.com

This instrument is manufactured in China.

The company reserves the right to change the specification or design without prior notice.

Megger is a registered trademark

The Bluetooth® word mark and logos are registered trademarks owned by Bluetooth SIG, Inc and are used under licence.

www.megger.com

AVO850_UG_en_V07

The word 'Megger' is a registered trademark. Copyright © 2025

Megger[®]