

AVO®415

TRMS Digital Multimeter with VFD Measurement

User Guide

Register
megger.com/register



Support
megger.com/support



This document is copyright of:

Megger Limited, Archcliffe Road, Dover, Kent CT17 9EN. ENGLAND
T +44 (0)1304 502101 F +44 (0)1304 207342 www.megger.com

Megger Limited reserves the right to alter the specification of its products from time to time without notice. Although every effort is made to ensure the accuracy of the information contained within this document it is not warranted or represented by Megger Limited to be a complete and up - to - date description.

For Patent information about this instrument refer to the following web site:
megger.com/patents

This manual supersedes all previous issues of this manual. Please ensure that you are using the most recent issue of this document. Destroy any copies that are of an older issue.

Declaration of Conformity

Hereby, Megger Instruments Limited declares that radio equipment manufactured by Megger Instruments Limited described in this user guide is in compliance with Directive 2014/53/EU. Other equipment manufactured by Megger Instruments Limited described in this user guide is in compliance with Directives 2014/30/EU and 2014/35/EU where they apply.

The full text of Megger Instruments EU declarations of conformity are available at the following internet address:
megger.com/company/about-us/eu-dofc

Contents

1. Introduction	7
1.1 Company web site	7
2. Safety warnings and standards	8
2.1 Warnings, cautions and notes	8
2.2 Safety warnings	8
2.2.1 Installation category definitions:	9
2.3 Safety, hazard and warning symbols on the instrument	9
2.4 Input protection limits	10
2.5 Features	11
3. Instrument overview	12
3.1 Unpacking and inspection	12
3.2 Instrument layout	12
3.3 Soft buttons	13
3.4 Terminals	13
3.5 Display	14
3.6 Function switch	15
4. Operation	16
4.1 Current measurements	16
4.1.1 AC current measurements	16
4.1.2 DC current measurements	19
4.2 Voltage measurement	20
4.2.1 V AC voltage measurements	20
4.2.2 V DC voltage measurement	23
4.2.3 Milli-Volts voltage measurements	24
4.3 Resistance, Continuity, Capacitance and Diode Testing	26
4.3.1 Resistance measurements	26
4.3.2 Diode test	27
4.3.3 Continuity check	28
4.3.4 Capacitance measurements	29
4.4 Frequency measurements	30
4.5 Temperature measurements	32

4.6	Soft buttons	33
4.6.1	Auto range / manual range selection	33
4.6.2	MAX/MIN mode	34
4.6.3	Relative mode	35
4.6.4	Display backlight	36
4.6.5	HOLD mode	36
4.6.6	Auto power off	36
4.6.7	Low battery indication	37
5.	Maintenance.	38
5.1	General maintenance	38
5.2	Cleaning	38
5.3	Battery	38
5.3.1	Battery status	38
6.	Battery and fuse replacement	39
6.1	Replacing the battery and fuses	39
6.1.1	Test the fuses	40
7.	Specifications	41
7.1	Electrical specifications	42
7.1.1	AC voltage 45 Hz to 1 kHz	42
7.1.2	DC voltage	42
7.1.3	AC current 45 Hz to 1 kHz	43
7.1.4	DC current	43
7.1.5	Resistance	43
7.1.6	Capacitance	44
7.1.7	Frequency (electronic)	44
7.1.8	Duty cycle	44
7.1.9	Temperature (Type-K)	45
7.2	Safety	45

8. Calibration, repair and warranty	46
8.1 Limited warranty	46
8.2 Repair and warranty	46
8.3 Instrument repair and spare parts	46
8.4 Returning and instrument for repair	46
8.5 Calibration, service and spare Parts	47
8.6 Approved repair companies	47
9. Decommissioning	48
9.1 WEEE Directive	48
9.2 Battery disposal	48
10. Worldwide sales offices	49

1. Introduction

The AVO415 is a True RMS digital multimeter with VFD (Variable frequency drive) measurement that are battery-powered, True RMS multimeter (hereafter “the Meter”) with a 6000-count display and meets IP67 for wet or dusty environments. This manual applies to this model and all figures show provided to customers convenience the accuracy or completeness of the product information is not guaranteed and is subject to change without notice. The meter meets CAT III and CAT IV IEC 61010-1 standards. The IEC 61010-1 safety standard defines four measurement categories (CAT I to IV) based on the magnitude of danger from transient impulses. See below for further information.

Read the ensuing safety regulations attentively before using this device.

1.1 Company web site

Occasionally an information bulletin may be issued via the Megger web site. This may concern new accessories, new usage instructions or a software update. Please occasionally check on the Megger web site for anything applicable to your Megger instruments.

www.megger.com

2. Safety warnings and standards

These safety warnings must be read and understood before the instrument is used. Retain for future reference.

2.1 Warnings, cautions and notes

This user guide follows the internationally recognised definition. These instructions must be adhered to at all times.

Description

WARNING : Indicates a potentially dangerous situation which, if ignored, could lead to death, serious injury or health problems.

CAUTION : Indicates a situation which could lead to damage of the equipment or environment

NOTE : Indicates important instructions to be followed to perform the relevant process safely and efficiently.

2.2 Safety warnings

The following safety information must be observed to ensure maximum personal safety during the operation of this meter:

- Do not use it in wet environments.
- Measurements beyond the maximum selected range must not be attempted.
- Extreme care must be taken when measuring above 50 V, especially on live exposed contacts.
- To measure voltage, the instrument must not be switched to a current or resistance range, or to the diode check or buzzer position.
- Circuits must be de-energised and isolated before carrying out resistance tests.
- The rotary selector switch must only be turned after removing test connections.
- To avoid false readings that could lead to electric shock and injury, replace the battery as soon as the low battery indicator () appears.
- All external voltages must be disconnected from the instrument before removing the battery.
- Never operate the meter unless the back cover and the battery/fuse cover is correctly in place and fastened securely with the manufactured supplied fastenings.
- Test leads and prods must be in good order, and free from defects e.g. broken or cracked insulation.
- UK Safety Authorities recommend the use of fused test leads when measuring voltage on high energy systems.
- Replacement fuses must be of the correct type and rating.
- The instrument must not be used if any part of it is damaged.
- Check for correct instrument operation by testing a known voltage before and after use. Do not use it if misleading results are obtained.
- Warnings and precautions must be read and understood before an instrument is used. They must be observed during the operation of this instrument.

- When using test leads or probes, keep your fingers behind the finger guards.
- Personal protective equipment should be used if there are ACCESSIBLE HAZARDOUS LIVE PARTS in the installation where measurement is to be carried out.
- Do not use the meter around explosive gas or vapor.
- Do not apply or remove test leads on or around uninsulated hazardous live conductors where a potential to cause electric shock, electrical burns or arc flash exists.

2.2.1 Installation category definitions:

CAT IV - Measurement category IV: Equipment connected between the origin of the low-voltage mains supply and distribution panel.









CAT III -Measurement category III: Equipment connected between the distribution panel and electrical outlets.

CAT II - Measurement category II: Equipment connected between the electrical outlets and user's equipment.







Measurement equipment may be safely connected to circuits at the marked rating or lower. The connection rating is that of the lowest rated component in the measurement circuit.

2.3 Safety, hazard and warning symbols on the instrument

Disconnect the test leads from the test points before changing the position of the function rotary switch. Never connect a source of voltage with the function rotary switch in Ω , $-(-)$, and ⏏ position. Do not expose meter to extremes of temperature or high humidity.

Icon	Description
	Warning: High Voltage, risk of electric shock
	Caution: Refer to user guide
	UK conformity. This equipment complies with current UK legislation
	EU conformity. Equipment complies with current EU directives
	Conforms to relevant Australian Safety and EMC standards
	AC measurement
	DC measurement
	Direct and alternating current

Safety warnings and standards

	Equipment protected by double or reinforced insulation
	Battery
	Earth
	Fuse
	Application around and removal from hazardous live conductors is permitted
	Do not dispose of via landfill, sewage system or by fire

2.4 Input protection limits

NEVER apply voltage or current to the instrument that exceeds the specified maximum:

Function	Maximum Input
V DC	1000 V DC RMS
V AC	1000 V AC RMS
mA AC/DC	800 mA
A AC/DC	10 A
Frequency, resistance, capacitance, diode test, continuity	250 V DC / AC RMS
Surge Protection	8 kV peak per IEC 61010

Unsafe voltage

WARNING : When the multimeter detects a potentially hazardous voltage, ≤ 30 V or a voltage overload (OL) in V mode, the symbol is displayed.

2.5 Features

- Safety rated CAT III 1000 V, CAT IV 600 V
- Accurate true RMS AC current and voltage
- Measure frequency up to 10 MHz
- Resistance, continuity, and diode measurements
- MIN/MAX mode
- Temperature measurement
- 100 mF capacitance range
- VFD AC voltage 50 to 700 V
- Bright backlight display
- High resolution 6000 counts display
- Current measurement to 10 A
- IP67 (dust-proof and waterproof) rating
- Designed and tested to withstand a 2 m (6.6 ft) drop

3. Instrument overview

3.1 Unpacking and inspection

Upon removing your new multimeter from its packing, you should have the following items:

- AVO415 Multimeter
- 1 m 4 mm non-fused, right angle test leads* (x2)
- 4 mm exposed metal Probes* (x2)
- Exposed tip probes for CAT II probing (x2)
- Red + Black crocodile clips*
- K-type multimeter adapter
- K-type thermocouple lead
- Soft case
- 4 mm cap plugs (x2)
- User guide
- 1x 9 V Carbon-Zinc , NEDA 1604S/IEC 6F22



*Ratings: : Double insulated, CAT III 1000 V, CAT IV 600 V, 10 A max

3.2 Instrument layout

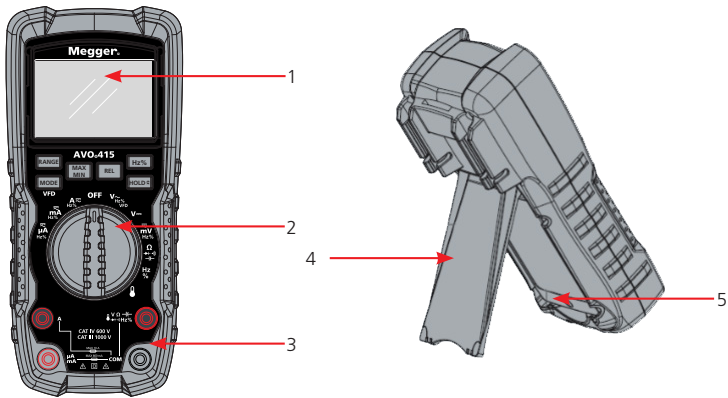

Item	Description	Item	Description
1.	6000 count LCD	4.	Tilt Stand
2.	Function Switch	5.	Battery Cover
3.	Terminals		

3.3 Soft buttons

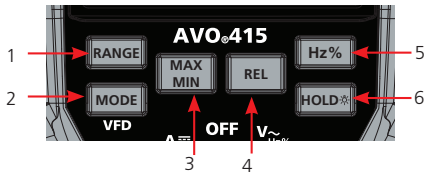

Item	Description	Item	Description
1.	Range button	4.	Relative button
2.	Mode button	5.	Hz and % button
3.	MAX/MIN button	6.	Hold and backlight button

3.4 Terminals

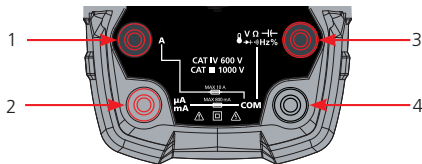

All functions except current use the VOHMS and COM input terminals. The two current input terminals.

Item	Description	Item	Description
1.	10 A Input terminal. Input for 0 A to 10.00 A current	6.	Positive input terminal. Input for voltage, continuity, resistance, diode test, capacitance
2.	μA mA Input terminal. Input for 0 A to 800 mA current	7.	Common input terminal. Return terminal for all measurements.

3.5 Display

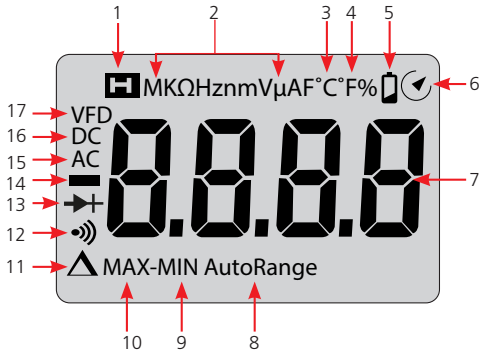

Item	Description	Item	Description
1.	Display hold	9.	Minimum
2.	Units of measure list	10.	Maximum
3.	Degrees Centigrade	11.	Relative
4.	Degrees Fahrenheit	12.	Continuity
5.	Battery status	13.	Diode test
6.	Auto power off	14.	Minus sign
7.	Measurement reading	15.	Alternating current
8.	Auto ranging	16.	Direct current
		17.	Frequency conversion measure

3.6 Function switch

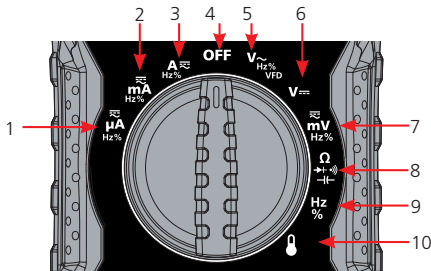

Turn the rotary switch to select a measurement function.

Item	Softkey	Function
1.	μA AC/DC	AC, DC micro-amps measurements
2.	mA AC/DC	AC, DC milli-amps measurements
3.	A AC/DC	AC, DC amps measurements
4.	OFF	
5.	V AC	AC voltage measurements
6.	V DC	DC voltage measurements
7.	mV AC/DC	DC, AC milli-volts measurements
8.	Ohms Diode Continuity Capacitance	Resistance, Diode test, Capacitance and Continuity measurements
9.	Hz %	Frequency measurements
10.	Temperature	Temperature measurements

4. Operation

WARNING : Risk of electrocution. High-voltage circuits, both AC and DC, are very dangerous and should be measured with great care.

- ALWAYS turn the rotary switch to the OFF when the meter is not in use.
- 'OL' appears in the display when a measurement value exceeds the range you have selected. Change to a higher range.



For user safety it is important to:

- Always connect the common (COM) probe first and then connect the live probe to the circuit or the instrument.
- Always remove the live probe first and then remove the common (COM) probe.

4.1 Current measurements

4.1.1 AC current measurements

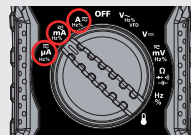

CAUTION : Do not make 10 A current measurements for longer than 30 seconds. Exceeding 30 seconds may cause damage to the meter and/or the test leads.

1. Set the function switch
For current measurements up to:
 - 1.1. 6000 μ A AC, set function switch to μ A
 - 1.2. 600 mA AC set function switch to mA
 - 1.3. 10 A Set function switch to A

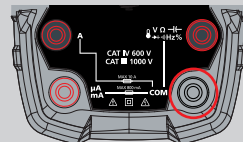

2. Insert the black test lead 4 mm plug into the COM terminal

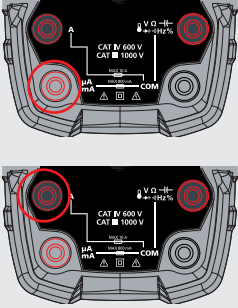
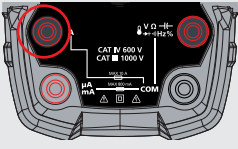

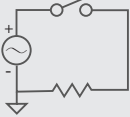
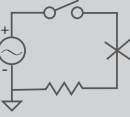
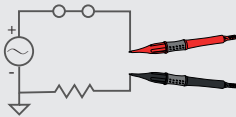
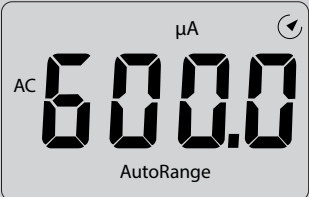
<p>3. For current measurements</p> <p>3.1. up to 6000 μA AC</p> <p>3.2. up to 600 mA AC</p> <p>Insert the red test lead 4 mm plug into the $\mu\text{A}/\text{mA}$ terminal</p>	
<p>4. For current measurements</p> <p>4.1. up to 10 A AC</p> <p>Insert the red test lead 4 mm plug into the A terminal</p>	
<p>5. Press the MODE button to cycle through setting until the display shows the AC current icon in top right hand side</p>	
<p>6. Turn off the power</p>	
<p>7. Break the circuit</p>	
<p>8. Insert the meter probes in series with the circuit</p> <p>9. Turn on the power</p>	
<p>10. The results will be displayed</p>	

Operation

11. Press the Hz% button until "Hz" is indicated to read the frequency in the display

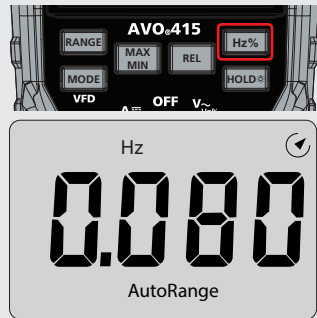

12. Press the Hz% button until "%" is indicated to read the % duty cycle in the display

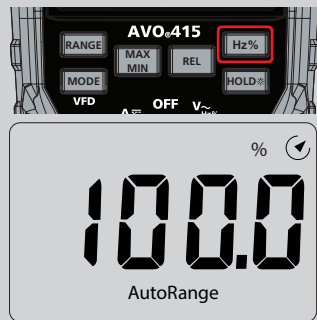

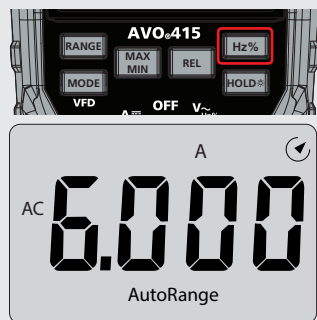

13. Press the Hz% button to return to current measurement

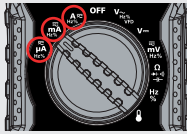
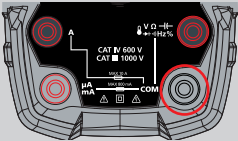
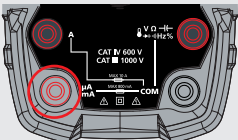
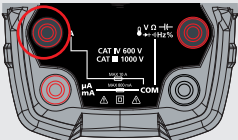

4.1.2 DC current measurements

CAUTION : Do not make 10 A current measurements for longer than 30 seconds. Exceeding 30 seconds may cause damage to the meter and/or the test leads.

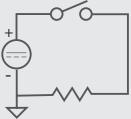
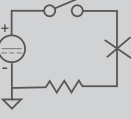
<ol style="list-style-type: none"> 1. Set the function switch For current measurements up to: <ol style="list-style-type: none"> 1.1. 6000 μA DC, set function switch to μA 1.2. 600 mA DC set function switch to mA 1.3. 10 A Set function switch to A 	
<ol style="list-style-type: none"> 2. Insert the black test lead 4 mm plug into the COM terminal 	
<ol style="list-style-type: none"> 3. For current measurements <ol style="list-style-type: none"> 3.1. up to 6000 μA DC 3.2. up to 600 mA DC <p>Insert the red test lead 4 mm plug into the μA/mA terminal</p> 	
<ol style="list-style-type: none"> 4. For current measurements <ol style="list-style-type: none"> 4.1. up to 10 A DC <p>Insert the red test lead 4 mm plug into the A terminal</p> 	
<ol style="list-style-type: none"> 5. Press the MODE button to cycle through setting until the display shows the DC current in top right hand side 	
<ol style="list-style-type: none"> 6. Turn off the power 	
<ol style="list-style-type: none"> 7. Break the circuit 	

Operation

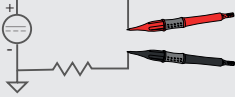
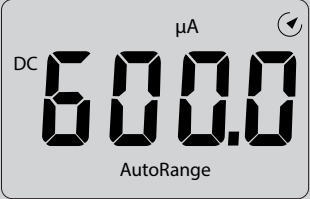
8. Insert the meter probes in series with the circuit	
9. Turn on the power 10. The results will be displayed	

4.2 Voltage measurement

The instrument features true RMS measurement, which gives accurate readings for distorted sine waves and other waveforms such as square waves, triangle waves, and staircase waves.

4.2.1 V AC voltage measurements

WARNING : Risk of Electrocutation.

The probe tips may not be long enough to contact the live parts inside some 240 V outlets as the contacts are recessed deep in the outlets.





This may result in the reading showing 0 V when the outlet has voltage on it.

Make sure the probe tips are touching the metal contacts inside the outlet before assuming that no voltage is present.

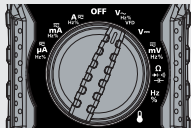
- Never attempt to make an in-circuit current measurement when the open circuit potential to earth is >1000 V.
- Check the Meter's fuse before testing. ([Consult chapter 6.1.1 Test the fuses on page 40](#)).
- Use the proper terminals, switch position, and range for your measurement.
- Never place the probes in parallel with a circuit or component when the leads are plugged into the A (Amps) terminal.

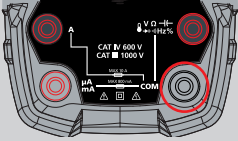
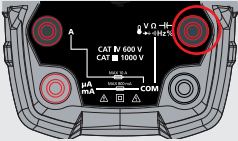
CAUTION : Do not measure AC voltages if a motor on the circuit is being switched ON or OFF, large voltage surges may occur that can damage the meter.

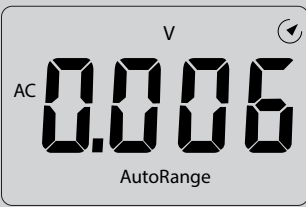
1. Set the switch to the V~ position AC will appear on the display	
---	---

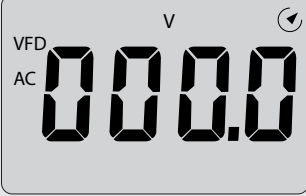
<p>2. Insert the black test lead 4 mm plug into the COM terminal</p>	
<p>3. Insert red test lead 4 mm plug into the V terminal</p>	
<p>4. Touch the black test probe tip to the negative side of the circuit</p>	
<p>5. Touch the red test probe tip to the positive side of the circuit</p>	
<p>6. The results will be displayed</p>	
<p>VFD Mode</p> <p>7. Press and hold the MODE button key for 2 seconds to indicate "VFD" on the display</p> <p>8. Read the VFD value in the display</p>	 

Operation

9. To exit VFD mode press and hold the MODE button for 2 seconds



Frequency / Duty cycle mode

10. Press the Hz% button until "Hz" is indicated to read the frequency in the display

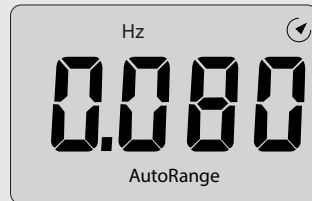

11. Press the Hz% button until "%" is indicated to read the % duty cycle in the display

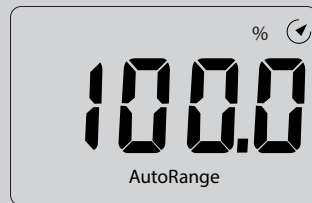

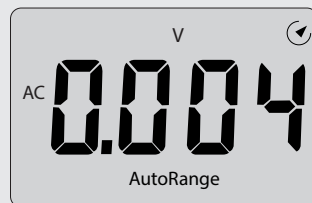

12. Press the Hz% button to return to the measurement



4.2.2 V DC voltage measurement

CAUTION : Do not measure DC voltages if a motor on the circuit is being switched ON or OFF.

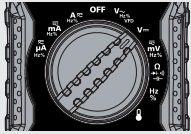
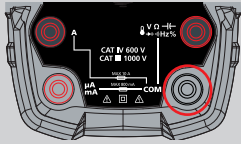
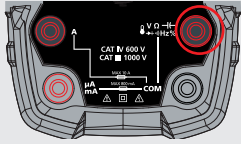

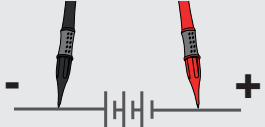
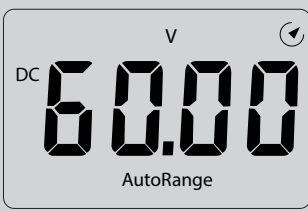

Large voltage surges may occur that can damage the meter.

<p>1. Set the switch to the V DC position</p>	
<p>2. Insert the black test lead 4 mm plug into the COM terminal</p>	
<p>3. Insert the red test lead 4 mm plug into the V terminal</p>	
<p>4. Touch the black test probe tip to the negative side of the circuit</p>	
<p>5. Touch the red test probe tip to the positive side of the circuit</p>	
<p>6. The results will be displayed</p>	

Operation

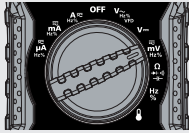
4.2.3 Milli-Volts voltage measurements

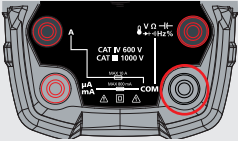
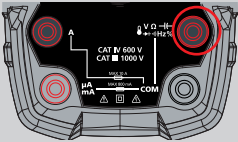
CAUTION : Do not measure mV voltages if a motor on the circuit is being switched ON or OFF. Large voltage surges may occur that can damage the meter.

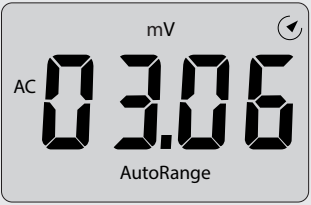
1. Set the switch to the mV position	
2. Press the MODE button to indicate DC or AC measurement	
3. Insert the black test lead 4 mm plug into the COM terminal	
4. Insert the red test lead 4 mm plug into the V terminal	
5. Touch the black test probe tip to the negative side of the circuit	
6. Touch the red test probe tip to the positive side of the circuit	
7. The results will be displayed	

Frequency / Duty cycle mode

8. Press the Hz% button until "Hz" is indicate to read the frequency in the display

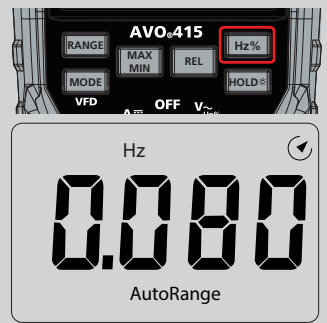

9. Press the Hz% button until "%" is indicate to read the % duty cycle in the display

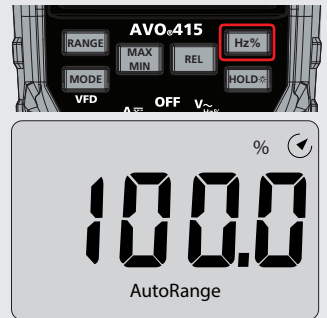



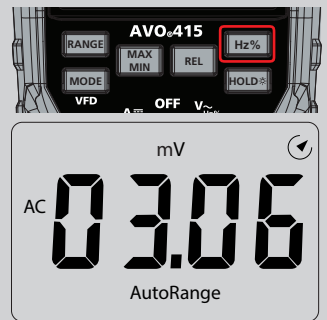

10. Press the Hz% button to return to the measurement





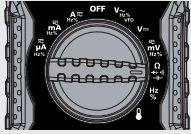
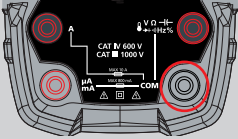
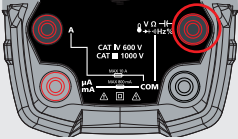

4.3 Resistance, Continuity, Capacitance and Diode Testing

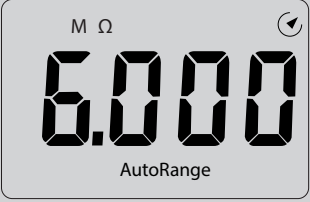
4.3.1 Resistance measurements

WARNING : To avoid electric shock, disconnect power to the unit under test and discharge all capacitors before taking any resistance measurements. Remove the batteries and unplug the line cords.

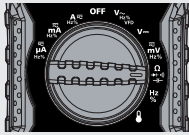
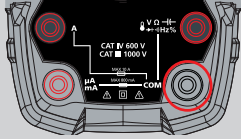
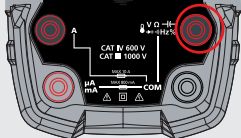

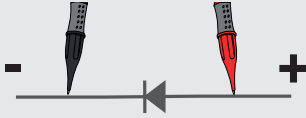
1. Set the function switch to the Ω position	
2. Insert the black test lead 4 mm plug into the COM terminal	
3. Insert the red test lead 4 mm plug into the Ω terminal	
4. Press the MODE button to indicate Ω on the display	
5. Touch the black test probe tip to the negative side of the circuit	
6. Touch the red test probe tip to the positive side of the circuit	
7. The results will be displayed	

4.3.2 Diode test

<p>1. Set the function switch to the Diode (➔) position</p>	
<p>2. Insert the black test lead 4 mm plug into the COM terminal</p>	
<p>3. Insert the red test lead 4 mm plug into the Diode (➔) terminal</p>	
<p>4. Press the MODE button to indicate diode and V on the display (V ➔)</p>	
<p>5. Touch the black test probe tip to the negative side of the circuit</p> <p>6. Touch the red test probe tip to the positive side of the circuit</p>	
<p>7. The results will be displayed</p> <p>NOTE : The voltage will typically indicate 0.400 to 3.200 V.</p> <p>NOTE : A reverse voltage will indicate "OL".</p> <p>NOTE : Shorted devices will indicate near "OV"</p> <p>NOTE : An open device will indicate "OL" in both polarities.</p>	

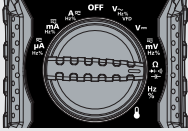
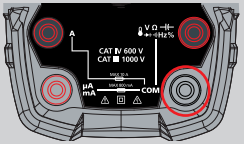
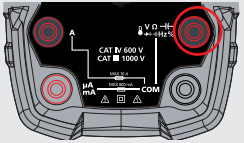

4.3.3 Continuity check

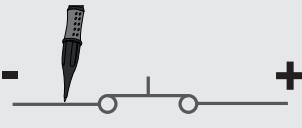
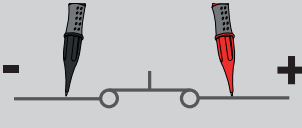
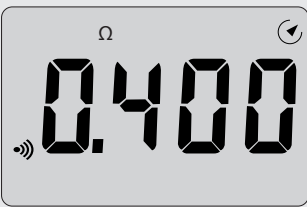
WARNING : To avoid electric shock, disconnect power to the unit under test and discharge all capacitors before taking any resistance measurements. Remove the batteries and unplug the line cords.

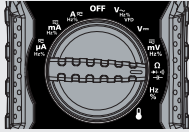
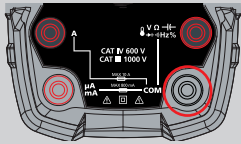
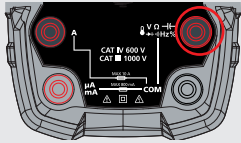

<p>1. Set the function switch to the continuity (🔊) position</p>	
<p>2. Insert the black test lead 4 mm plug into the COM terminal</p>	
<p>3. Insert the red test lead 4 mm plug into the continuity (🔊) terminal</p>	
<p>4. Press the MODE button to indicate continuity and Ω on the display (Ω)</p>	
<p>5. Touch the black test probe tip to the negative side of the circuit</p>	
<p>6. Touch the red test probe tip to the positive side of the circuit</p>	
<p>7. The results will be displayed</p> <p>NOTE : If the resistance is less than approximately 50 Ω, the audible signal will sound. If the circuit is open, the display will indicate "OL".</p>	

4.3.4 Capacitance measurements

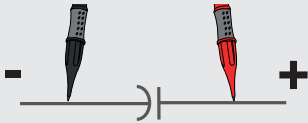
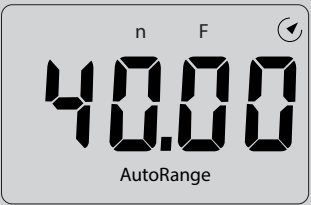
WARNING : To avoid electric shock, disconnect power to the unit under test and discharge all capacitors before taking any capacitance measurements. Remove the batteries and unplug the line cords.

<p>1. Set the function switch to the Capacitance (—) position</p>	
<p>2. Insert the black test lead 4 mm plug into the COM terminal</p>	
<p>3. Insert the red test lead 4 mm plug into the Capacitance (—) terminal</p>	
<p>4. Press the MODE button to indicate (F) on the display</p>	
<p>5. Touch the black test probe tip to the negative side of the circuit</p> <p>6. Touch the red test probe tip to the positive side of the circuit</p>	
<p>7. The results will be displayed</p> <p>NOTE : The test may take up to 3 minutes or more for large capacitors to charge. Wait until the readings settle before ending the test.</p>	

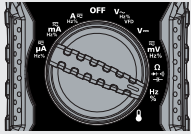
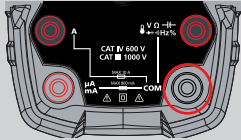
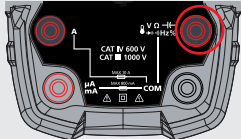
4.4 Frequency measurements

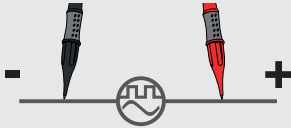
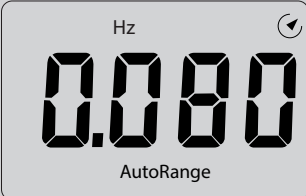
<p>1. Set the switch to the Hz% position</p>	
<p>2. Insert the black test lead 4 mm plug into the COM terminal</p>	
<p>3. Insert the red test lead 4 mm plug into the Hz% terminal</p>	
<p>4. Touch the black test probe tip to the negative side of the circuit</p>	
<p>5. Touch the red test probe tip to the positive side of the circuit</p>	
<p>6. Read the frequency in the display</p>	

7. Press the Hz% button until “%” is indicate to read the % duty cycle in the display

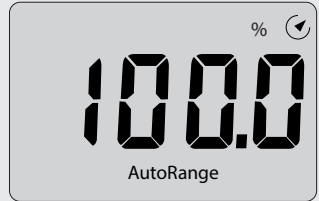



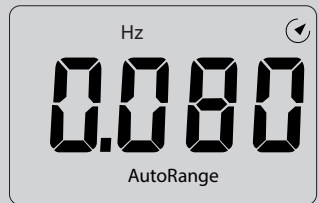

8. Press the Hz% button to return to the measurement

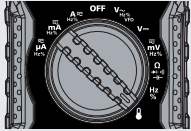
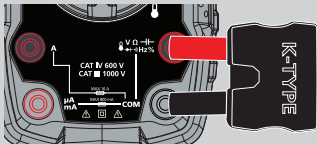
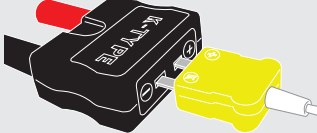

4.5 Temperature measurements

WARNING : Do not connect K-type lead to live circuits.



<p>1. Set the function switch to the Temperature position</p>	
<p>2. Insert the K-type adapter into the COM and Temp terminal</p> <p>NOTE : Check the black goes to COM and red TEMP</p>	
<p>3. Connect the wire probe to the K-type adapter check making sure to observe the correct polarity + to + and - to -</p>	
<p>4. Press the MODE button to change the temperature units (°C or °F), displayed in top right hand side</p>	
<p>5. Place probe tip at heat source to be measured</p>	
<p>6. The results will be displayed</p>	

4.6 Soft buttons

4.6.1 Auto range / manual range selection

The default setting for this multimeter is Auto Range. Auto Range automatically selects the best range for the measurements being made.

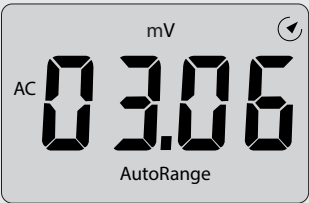
To change between Auto and Manual:

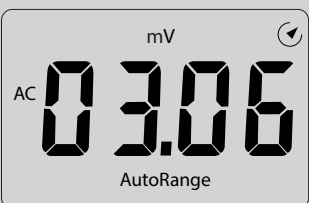
<p>1. Select the test required</p>	
<p>2. Press the RANGE key. The "AutoRange" display indicator will turn off</p>	
<p>3. Press the RANGE key to step through the available ranges until you select the range you want</p>	
<p>4. To return to Auto Range, press and hold the RANGE key for 2 seconds</p>	

NOTE : Manual ranging does not apply for the Frequency functions.

4.6.2 MAX/MIN mode

NOTE : When using the MAX/MIN function in Auto range mode, the meter will lock into the range that is displayed on the LCD when MAX/MIN is activated. If a MAX/MIN reading exceeds that range, an OL will be displayed.

1. Select the test required and Auto or Manual range (by pressing the RANGE) button [Consult chapter 4.6.1 Auto Range/Manual Range Selection on page 33](#)



NOTE : This must be done BEFORE entering MAX/MIN mode.

2. Press the MAX/MIN key once to activate the MAX recording mode.
The display icon "MAX" will appear.
The meter will display and hold the maximum reading and will update only when a new "MAX" occurs



3. Press the MAX/MIN key again to activate the MIN recording mode.
The display icon "MIN" will appear.
The meter will display and hold the minimum reading and will update only when a new minimum occurs



4. Press the MAX/MIN key again to activate the MAX/MIN recording mode.
The display icon "MAX-MIN" will appear.
The meter will display and hold the difference between the MAX and MIN reading

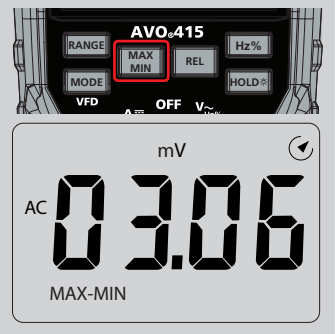

5. To exit MAX/MIN mode press and hold the MAX/MIN key for 2 seconds



4.6.3 Relative mode

- The relative measurement feature allows you to make measurements relative to a stored reference value.
- A reference voltage, current, etc. can be stored and measurements made in comparison to that value.
- The displayed value is the difference between the reference value and the measured value.

1. Perform the measurement as described in the operating instructions

2. Press the REL button to store the reading in the display and the REL Δ indicator will appear on the display

3. The display will now indicate the difference between the stored value and the measured value

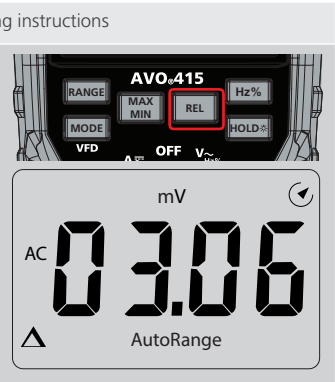

4. Press the REL button to exit the relative mode



NOTE : The Relative function does not operate in the Frequency function.

Operation

4.6.4 Display backlight

1. Press and hold the HOLD key for >1 second to turn on or off the display backlight function



2. The backlight will automatically turn off after 5 minutes

4.6.5 HOLD mode

- The hold function freezes the reading in the display



- Press the HOLD key momentarily to activate or to exit the HOLD function

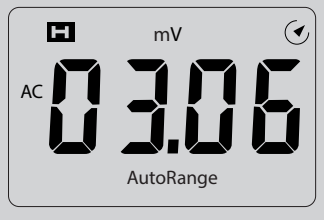

4.6.6 Auto power off

The auto off feature will turn the meter off after 15 minutes.

To disable the auto power off:

1. Switch off the multimeter

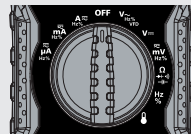

2. Press and hold the MODE button



3. Turn the meter on while holding the MODE button

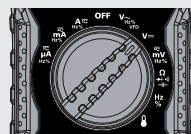

NOTE : The multimeter will beep and monumentally display this before returning to the test chosen

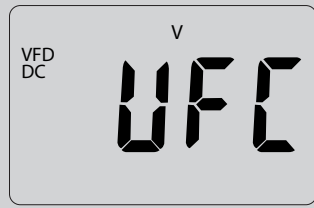

To enable auto power OFF

Switch the multimeter off and on again.

4.6.7 Low battery indication

- The icon will appear in the display when the battery voltage becomes low.
- Replace the battery when this appears. [Consult chapter 6.1 Replacing the battery and fuses on page 39](#)



Maintenance.

5. Maintenance.

WARNING : To avoid electric shock, disconnect the test leads from any source of voltage before removing the back cover or the battery or fuse covers.

WARNING : To avoid electric shock, do not operate your meter until the battery and fuse covers are in place and fastened securely.

NOTE : There are no user replaceable parts within this product, other than the battery cells and the fuses.

This Multimeter is designed to provide years of dependable service, if the following care instructions are performed:

5.1 General maintenance

- Ensure the unit is kept clean and dry after use.
- Close all covers when not in use.
- Test leads and adaptors should be checked before use for damage and continuity.
- Use only fresh batteries of the recommended size and type, remove old or weak batteries so they do not leak and damage the unit.
- If the meter is to be stored for a long period of time; the batteries should be removed to prevent damage to the unit.

5.2 Cleaning

Disconnect from mains power / charger.

Switch off and remove battery cells.

Wipe the instrument with a clean cloth dampened with either water or isopropyl alcohol (IPA).

5.3 Battery

WARNING : Always set the instrument to OFF before battery cells are removed or installed.

CAUTION : Old batteries must be disposed of in accordance with local regulations.

CAUTION : Only use approved batteries as defined below.

Battery (and fuses) are user-accessible using a screwdriver to remove access covers to the left of the grip (and to the right of the barrel respectively).

To help maintain the health, reliability and longevity of the installed batteries:

Remove battery cells if the instrument is not going to be used for a long period.

Store batteries in a cool, dry place. Batteries can be damaged when exposed to heat.

5.3.1 Battery status

WARNING : Do not recharge Alkaline batteries.

Battery condition icon is positioned at the top right hand corner of display. This icon is displayed at all times when the instrument is switched on. When running the icon will indicate state of charge, the icon will be filled in proportion to the state of charge.

6. Battery and fuse replacement

WARNING : Switch off the instrument and remove any connection before removing the battery cover.



CAUTION : Batteries should not be left in the instrument if remaining unused for an extended period.

The battery pack is user-accessible using a screwdriver or penny to undo the latch then open the access cover.

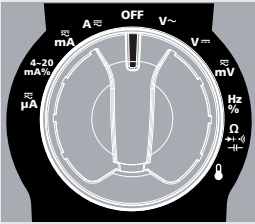
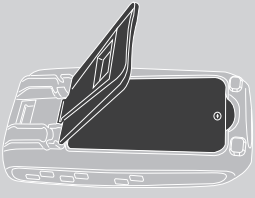

Fuses are user-accessible using a screwdriver or penny to undo the latch then open the access cover.

6.1 Replacing the battery and fuses

WARNING : To avoid electric shock, disconnect the test leads from any source of voltage. Remove test leads and turn OFF the multimeter before opening or accessing any part of the unit.

Description	Part Number
10 A 1000 V 30 kA Fast Acting Ultra Rapid Ceramic Fuse	50 199 06 / 10 A
800 mA 1000 V 30 kA Fast Acting Ultra Rapid Ceramic Fuse	70-172-40 / 0.8 A
1. Turn the multimeter off and remove the test leads from the terminals	
2. Extend the tilt stand to expose the battery door	
3. Open the rear battery cover by removing the screw using a Phillips head screwdriver	

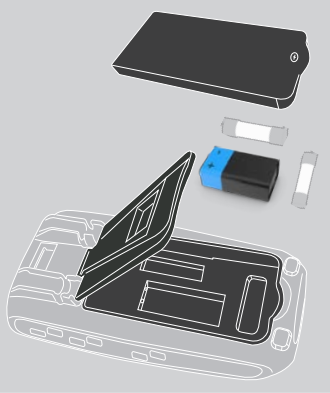
Battery and fuse replacement

4. Lift the battery cover off of the instrument	
5. Remove the batteries and fuses. Use correct tool to avoid damaging components inside	
<p>NOTE : Use ONLY fuses with the amperage, interrupt, voltage, and speed rating specified.</p>	
6. Replacing the batteries	
6.1. Insert the battery into battery holder, observing the correct polarity!	
7. To fit the fuse/battery cover back on	
8. Secure with the screw	

WARNING : To avoid electric shock, do not operate the meter until the battery cover is in place and fastened securely.

NOTE : If your meter does not work properly, check the fuses and batteries to make sure that they are still good and that are properly inserted.

6.1.1 Test the fuses

Test fuses as shown below.

800 mA fuse	10 A fuses
800 mA $<200 \Omega = \text{OK}$	10 A $< 2 \Omega = \text{OK}$
800 mA OL = Fuse not OK	10 A OL = Fuse not OK

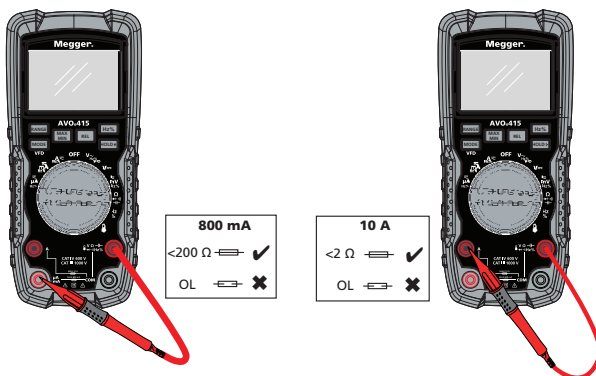

7. Specifications

Accuracy is specified for 1 year after calibration, at operating temperatures of 18 °C to 28 °C, with relative humidity at 0 % to 90 %. Accuracy specifications take the form of: \pm ([% of Reading] + [Counts])

Specification	Detail
Maximum voltage between any terminal and earth ground	1000 V
F1 Fuse Protection for A inputs	10 A, 1000 V, 30 kA
F2 Fuse Protection for mA input	800 mA, 1000 V, 30 kA
Battery	NEDA 1604 6F22 (lithium-ion 9 V PP3)
Display	6000 count, backlit liquid crystal
Altitude	2000 m maximum.
Operating temperature	5 °C to +40 °C (41 °F to 104 °F)
Storage temperature	-20 °C to +60 °C (-4 °F to 140 °F)
Operating humidity	Max 80% up to 31 °C (87 °F) decreasing linearly to 50% at 40 °C (104 °F).
Storage humidity	50% at 40 °C (104 °F)
Size (H x W x D)	180 mm x 82 mm x 55 mm
Weight	397 g without battery 427 g with battery
Safety	IEC 61010-1: Pollution Degree 2 IEC 61010-2-033: CAT IV 600 V, CAT III 1000 V
EMC	IEC 61326-1: Portable Electromagnetic Environment, CISPR 11: Group 1, Class A, IEC 61326-2-2
Enclosure	Double moulded, IP67 rating
Shock (drop test)	6.5 feet (2 meters)
Continuity check	Audible signal will sound if the resistance is less than 50 Ω (approx.), test current <0.35 mA
Diode test	Test current of 0.9 mA maximum, open circuit voltage 3.2 V DC typical
PEAK	Captures peaks > 1 ms
Temperature sensor	Requires type K thermocouple
Input impedance	> 10 M Ω V DC and >10 M Ω V AC
Crest factor	\leq 3 at full scale up to 500 V, decreasing linearly to \leq 1.5 at 1000 V.
AC Response	True RMS

Specifications

AC True RMS	The term stands for "Root-Mean-Square," which represents the method of calculation of the voltage or current value. Average responding multimeters are calibrated to read correctly only on sine waves, and they will read inaccurately on non-sine wave or distorted signals. True rms meters read accurately on either type of signal
ACV bandwidth	45 Hz to 1 kHz
Overrange indication	OL is displayed
Auto Power OFF	15 minutes (approximately) with disable feature
Polarity	Automatic (no indication for positive); Minus (-) sign for negative
Low battery indication	 " Battery low warning
Measurement rate	2 times per second

7.1 Electrical specifications

7.1.1 AC voltage 45 Hz to 1 kHz

Range	Resolution	Accuracy
60.00 mV	0.01 mV	$\pm(0.9\% + 9 \text{ digits})$
600.0 mV	0.1 mV	$\pm(0.8\% + 3 \text{ digits})$
6.000 V	0.001 V	
60.00 V	0.01 V	
600.0 V	0.1 V	
1000 V	1 V	$\pm(0.8\% + 8 \text{ digits})$

All AC voltage ranges are specified from 5% of range to 100% of range.

AC voltage bandwidth: 45 Hz to 1 kHz (Sine); 50/60 Hz (All wave).

Variable frequency drive (VFD)

50 to 700 V	1 V	$\pm(0.4\% + 3 \text{ digits})$
-------------	-----	---------------------------------

7.1.2 DC voltage

Range	Resolution	Accuracy
60.00 mV	0.01 mV	$\pm(0.9\% + 9 \text{ digits})$
600.0 mV	0.1 mV	$\pm(0.5\% + 5 \text{ digits})$
6.000 V	0.001 V	
60.00 V	0.01 V	
600.0 V	0.1 V	
1000 V	1 V	$\pm(0.6\% + 6 \text{ digits})$

7.1.3 AC current 45 Hz to 1 kHz

Range	Resolution	Accuracy
600.0 μ A	0.1 μ A	$\pm(1.5\% + 3 \text{ digits})$
6000 μ A	1 μ A	
60.00 mA	0.01 mA	
600.0 mA	0.1 mA	
6 A	0.001 A	$\pm(2.0\% + 3 \text{ digits})$
10 A	0.01 A	

10 A: 30 sec max with reduced accuracy.

All AC current ranges are specified from 5% of range to 100% of range.

AC current bandwidth: 45 Hz to 1 kHz (Sine); 50/60 Hz (All wave).

Amps input burden voltage (typical): mA input $\sim 3.8 \text{ mV/A}$, A input $\sim 30 \text{ mV/A}$.

7.1.4 DC current

Range	Resolution	Accuracy
600.0 μ A	0.1 μ A	$\pm(1.0\% + 3 \text{ digits})$
6000 μ A	1 μ A	
60.00 mA	0.01 mA	
600.0 mA	0.1 mA	
6 A	0.001 A	$\pm(1.5\% + 3 \text{ digits})$
10 A	0.01 A	

7.1.5 Resistance

Range	Resolution	Accuracy
600.0 Ω	0.1 Ω	$\pm(1.0\% + 2 \text{ digits})$
6.000 k Ω	0.001 k Ω	$\pm(0.8\% + 2 \text{ digits})$
60.00 k Ω	0.01 k Ω	
600.0 k Ω	0.1 k Ω	
6.000 M Ω	0.001 M Ω	$\pm(1.2\% + 2 \text{ digits})$
60.00 M Ω	0.01 M Ω	$\pm(1.0\% + 5 \text{ digits})$

Specifications

7.1.6 Capacitance

Range	Resolution	Accuracy
99.99 nF*	0.01 nF	$\pm(5.0\% + 20 \text{ digits})$
999.9 nF 9.999 μ F 99.99 μ F 999.9 μ F	0.1 nF 0.001 μ F 0.01 μ F 0.1 μ F	$\pm(4.0\% + 5 \text{ digits})$
9.999 mF 99.99 mF	0.001 mF 0.01 mF	$\pm 10\% \text{ reading}$

*<99.99 nF Not specified

7.1.7 Frequency (electronic)

Range	Resolution	Accuracy
9.999 Hz	0.001 Hz	$\pm(0.1\% + 4 \text{ digits})$
99.99 Hz	0.01 Hz	
999.9 Hz	0.1 Hz	
9.999 kHz	0.001 kHz	
99.99 kHz	0.01 kHz	
999.9 kHz	0.1 kHz	
9.999 MHz	0.001 MHz	

Sensitivity: 0.8 V RMS min. at 20% to 80% duty cycle and <100 kHz:
5 Vrms min at 20% to 80% duty cycle and >100 kHz.

10.00-1 kHz	0.01 Hz	$\pm 0.5\% \text{ reading}$
-------------	---------	-----------------------------

Sensitivity: AC mV Range (>100 mV), ACV Range (6% Range);
6 000 μ A / 600 mA / 10.00 A Range (6% Range);
600 μ A / 60.00 mA / 6.000 A (> 60% Range)

Pulse width: 100 μ s - 100 ms:

Frequency: 5 Hz to 150 kHz

7.1.8 Duty cycle

Range	Resolution	Accuracy
0.1 to 99.90%	0.01%	$\pm (1.2\% \text{ reading} + 2 \text{ digits})$

Pulse width: 100 μ s – 100 ms,

Frequency: 5 Hz to 150 kHz

7.1.9 Temperature (Type K thermocouple)

Range	Resolution	Accuracy
-40 to 1000 °C	1 °C	±(3.0% + 3 °C / 5 °F digits) (Probe accuracy not included)
-50 to 1832 °F	1 °F	

NOTE : Accuracy specifications consist of two elements:

- (%reading) - This is the accuracy of the measurement circuit
- (+digits) - This is the accuracy of the analogue to digital converter.

NOTE : Accuracy is stated at 18 to 28 °C (65 to 83 °F) and less than 75% RH.

7.2 Safety

This instrument is intended for origin of installation use and are protected by double insulation per 61010-1:2010 +A1:2019 Safety requirements for electrical equipment for measurement, control, and laboratory use to Measurement connection: CAT III 1000 V and CAT IV 600 V; Pollution Degree 2. The instrument also meets EN (IEC) 61010-2-033:2021 +A11:2021, particular requirements for hand-held multimeters and other meters, 61010-031:2015, Safety requirements for hand-held probe assemblies for electrical measurement and test, EN 62479: 2010 Assessment of the compliance of low power electronic and electrical equipment with the basic restrictions related to human exposure to electromagnetic fields (10 MHz to 300 GHz); and EN 50663: 2017 Generic standard for assessment of low power electronic and electrical equipment related to human exposure restrictions for electromagnetic fields (10 MHz - 300 GHz).

8. Calibration, repair and warranty

8.1 Limited warranty

This Megger product will be free from defects in material and workmanship for three years from the date of purchase. This warranty does not cover fuses, disposable batteries, or damage from accident, neglect, misuse, alteration, contamination, or abnormal conditions of operation or handling.

8.2 Repair and warranty

The instrument contains static sensitive devices, and care must be taken in handling the printed circuit board. If an instrument's protection has been impaired, it should not be used but sent for repair by suitably trained and qualified personnel. The protection is likely to be impaired if for example, it shows visible damage; fails to perform the intended measurements; has been subjected to prolonged storage under unfavourable conditions or has been subjected to severe transport stresses.

NOTE : Any unauthorised prior repair or adjustment will automatically invalidate the warranty.

8.3 Instrument repair and spare parts

For service requirements contact Megger instruments or an approved repair company.

Megger Limited

Archcliffe Road

Dover

Kent

CT17 9EN

U.K.

Tel: +44 (0) 1304 502 243

Fax: +44 (0) 1304 207 342

8.4 Returning and instrument for repair

WARNING : Remove the battery cells before shipping this instrument.

If it is necessary to return an instrument for repair, a Returns Authorisation number must first be obtained by contacting one of the addresses shown. You will be asked to provide key information, such as the instrument serial number and fault reported when the number is issued. This will enable the Service Department to prepare in advance for the receipt of your instrument, and to provide the best possible service to you. The Returns Authorisation number should be clearly marked on the outside of the product packaging, and on any related correspondence. The instrument should be sent, freight paid to the appropriate address. If appropriate a copies of the original purchase invoice and of the packing note, should be sent simultaneously by airmail to expedite clearance through customs. For instruments requiring repair outside the warranty period a repair estimate will be submitted to the sender, if required, before work on the instrument commences. Approved Repair Companies A number of independent instrument repair companies have been authorised for repair work on most Megger instruments, using genuine Megger spare parts. A list of approved companies is available from the UK address shown.

8.5 Calibration, service and spare Parts

For service requirements for Megger Instruments contact **Megger** or your local distributor or authorised repair centre.

Megger operates fully traceable calibration and repair facilities, to make sure your instrument continues to provide the high standard of performance and workmanship you expect. These facilities are complemented by a worldwide network of approved repair and calibration companies to offer excellent in-service care for your Megger products.

See the **last page** of this User Guide for Megger contact details.

To find your local Authorised Service Centre email Megger on **ukrepairs@megger.com** and give details of your location.

8.6 Approved repair companies

A number of independent instrument repair companies have been approved to do repair work on most Megger instruments, complete with genuine Megger spare parts.

Consult the Appointed Distributor / Agent about spare parts, repair facilities and advice.

9. Decommissioning

9.1 WEEE Directive



The crossed out wheeled bin symbol placed on Megger products is a reminder not to dispose of the product at the end of its life with general waste.

Megger is registered in the UK as a Producer of Electrical and Electronic Equipment. The Registration No is WEE/ HE0146QT.

For further information about disposal of the product consult your local Megger company or distributor or visit your local Megger website.

9.2 Battery disposal

The crossed out wheeled bin symbol placed on a battery is a reminder not to dispose of batteries with general waste when they reach the end of their usable life.

For disposal of batteries in other parts of the EU contact your local Megger branch or distributor.

Megger is registered in the UK as a producer of batteries (registration No.: BPRN00142).

For further information see www.megger.com

10. Worldwide sales offices

Sales Office	Telephone	Email
UK	T. +44 (0)1 304 502101	E. UKsales@megger.com
USA – Dallas	T. +1 214 333 3201	E. USsales@megger.com
USA – Valley Forge	T. +1 214 333 3201	E. USsales@megger.com
USA – Dallas	T. +1 214 333 3201	E. USsales@megger.com
DEUTSCHLAND – Aachen	T. +49 (0) 241 91380 500	E. info@megger.de
SVERIGE	T. +46 08 510 195 00	E. seinfo@megger.com
中国	T. +86 512 6556 7262	E. meggerchina@megger.com
中国 - 香港	T. +852 26189964	E. meggerchina@megger.com
ČESKÁ REPUBLIKA	T. +420 222 520 508	E. info.cz@megger.com
América Latina	T. +1 214 330 3293	E. csasales@megger.com
ESPAÑA	T. +34 916 16 54 96	E. info.es@megger.com
SUOMI	T. +358 08 510 195 00	E. seinfo@megger.com
LA FRANCE	T. +01 30 16 08 90	E. infos@megger.com
ΕΛΛΑΔΑ	T. +49 (0) 9544 68 0	E. sales@sebakmt.com
Magyarország	T. +36 1 214-2512	E. info@megger.hu
ITALIA	T. +49 (0) 9544 68 0	E. sales@sebakmt.com
日本	T. +44 (0)1 304 502101	E. UKsales@megger.com
한국	T. +1-800-723-2861	E. sales@megger.com
ضاي رلا ةب رل	T. +966 55 111 6836	E. MESales@megger.com
ن رل ةك ل م م	T. +973 17440620	E. MESales@megger.com
NEDERLAND	T. +46 08 510 195 00	E. seinfo@megger.com
NORGE	T. +46 08 510 195 00	E. seinfo@megger.com
POLSKA	T. +48 22 2809 808	E. info.pl@megger.com
PORTUGAL	T. +34 916 16 54 96	E. info.es@megger.com
România	T. +40 21 2309138	E. info.ro@megger.com
РОССИЯ	T. +7 495 2 34 91 61	E. sebaso@sebaspectrum.ru
SLOVENSKO	T. +421 2 554 23 958	E. info.sk@megger.com
Türkiye	T. +46 08 510 195 00	E. seinfo@megger.com



Local Sales office

Megger Limited
Archcliffe Road
Dover
Kent
CT17 9EN
ENGLAND
T. +44 (0)1 304 502101
F. +44 (0)1 304 207342

Manufacturing sites

Megger Limited
Dover, ENGLAND
T. +44 (0)1 304 502101
E. uksales@megger.com

Megger AB
Danderyd, SWEDEN
T. +46 08 510 195 00
E. seinfo@megger.com

Megger Valley Forge
Phoenixville, PA USA
T. +1 610 676 8500
E. USSales@megger.com

Megger USA - Dallas
Dallas, TX USA
T. +1 214 333 3201
E. USSales@megger.com

Megger USA - Fort Collins
Fort Collins, CO USA
T. +1 970 282 1200

Megger GmbH
Aachen, GERMANY
T. +49 (0) 241 91380 500
E. info@megger.de

Megger Germany GmbH
Baunach, GERMANY
T. +49 (0) 9544 68 - 0
E. baunach@megger.com

Megger Germany GmbH
Radeburg, GERMANY
T. +49 (0) 35208 84-0
E. radeburg@megger.com

This instrument is manufactured in China.

The company reserves the right to change the specification or design without prior notice.

Megger is a registered trademark

The Bluetooth[®] word mark and logos are registered trademarks owned by Bluetooth SIG, Inc and is used under licence.