



FALCO 2 11.7 VOC Detector

Instrument User Manual V1.0



Register
your instrument
online to receive your
extended warranty

Register your instrument online for extended warranty

Thank you for purchasing your Ion Science instrument.

The standard warranty of your instrument can be extended to two
years.

To receive your extended warranty, you must register your
instrument online within one month of purchase (terms and
conditions apply).

Click [here](#) to extend your instrument warranty, or scan the QR code
below.





Contents

Safety	6
Legal Notices Regarding the Safe Operation of Equipment.....	6
Symbols.....	6
Warnings, Cautions and Information notifications	6
Disposal.....	8
Certifications	8
Statements	8
Responsibility for Correct Use	8
Warnings.....	8
Introduction	9
Specification	10
Unpacking and inspection	11
System Description	12
Outputs and Communications.....	12
RS 485 Modbus Interface	12
Installation Requirements	13
Location Requirements.....	13
Power Requirements	13
Cable and Gland Requirements.....	13
National Pipe Tapered Thread	13
Installation	14
Preparation for Installation	14
Dimensions for Installation.....	14
To Install the Housing Module	15
To install the FALCO 2 11.7 as a complete assembly.....	15
After-Installation Test.....	16
Installation in Zones with Explosive Atmospheres	16
Configurations of the 4–20 mA Current Loop	16
Duty Cycling Measurement	18
Removal of the Control Module	18
To Remove the Control Module	18
Operating the FALCO 2 11.7	19



User Interface19

 Keypad19

 Status Light19

Start-Up Routine 20

 Logo Screen20

 Info screen 120

 Info screen 220

 Warm-up.....20

Normal Operation 21

 Display Overview21

 Display Menu Navigation.....21

 Lock Screen22

 Navigating the Menus and Selecting Menu Options.....22

 Menu i1.....23

 Menu i2.....23

 Menu i3.....23

 Menu i4.....24

 Menu i5.....24

 Menu i6.....24

 Menu i7.....25

 Menu i8.....25

Calibration 25

 Zero.....26

 Span 126

 RF (Response Factor)27

Detection Units 27

Alarms 28

 Alarm 1.....28

 Alarm 2.....28

Alarm Brightness..... 28

Alarm Pulsing..... 29

Relays..... 29

 Relay 1 Options.....29



Relay 2 Options30

4-20 mA 30

 4 – 20 mA Enable/Disable.....30

 4 - 20mA Range.....30

Modbus Address 30

Status Light Brightness 31

Service Mode..... 31

Password Lock 32

Servicing and Maintenance 32

 General maintenance32

 Cleaning32

 Firmware and Software32

 MiniPID2 Electrode Stack Replacement33

 MiniPID2 Reassembly34

 Replacing the Lamp34

 Cleaning the 11.7 eV Lamp35

 Filter Disc35

 Replacement.....35

 Bump Test35

Fault Diagnostics 36

 Alarm and Fault Indications.....36

 Fault Conditions37

Manual Log..... 38

Quality Assurance 38

Warranty..... 38

 Instrument38

 Lamp38

Service..... 38

ION Science Contact Details..... 39

Safety

Legal Notices Regarding the Safe Operation of Equipment

- Whilst every attempt is made to ensure the accuracy of the information contained in this manual, ION Science accepts no liability for errors or omissions in the manual, or any consequences deriving from the use of information contained herein. It is provided “as is” and without any representation, term, condition or warranty of any kind, either expressed or implied.
- To the extent permitted by law, ION Science shall not be liable to any person or entity for any loss or damage which may arise from the use of this manual.
- We reserve the right at any time and without any notice to remove, amend or vary any of the content which appears in this manual.

Symbols



WARNING!
USED TO INDICATE DANGER WARNINGS WHERE THERE IS A RISK OF INJURY OR DEATH.



Caution
Used to indicate a caution where there is a risk of damage to equipment.



Information
Important information or useful hints about usage.



Recycling
Recycle all packaging.



WEEE Regulations
Ensure that waste electrical equipment is disposed of correctly.

Warnings, Cautions and Information notifications

The following Cautions apply to the product described in this manual.



Inadequate performance of the gas detection equipment described in this manual may not necessarily be self-evident and consequently equipment must be regularly inspected and maintained.



ION Science recommends that personnel responsible for equipment use institute a regime of regular checks to ensure it performs within calibration limits, and that a record be maintained which logs calibration check data.



The equipment should be used in accordance with the safety standards and installation instructions given in this manual, and in compliance with local safety standards.



Protect the PID sensor from exposure to silicone vapours as this may foul the windows of the lamps and reduce response to some gases. This can usually be remedied by polishing the lamp window with alumina powder.



Do not use abrasive or chemical detergents to clean the FALCO 2 11.7 instrument as this may reduce the antistatic properties of the materials used, clean it using a damp cloth only.



The FALCO 2 11.7 must not be exposed to atmospheres known to have an adverse effect on Thermoplastic Elastomers or Polycarbonate.



Outside the items covered in this manual, the FALCO 2 11.7 must be serviced in a Non-Hazardous environment and by ION Science Ltd authorised service centres only. Substitution of components may impair intrinsic safety.



Ingress Protection: Continuous exposure to wet weather conditions should be limited to less than one day and harsh water spray conditions should be avoided.



Proper Use: If the equipment is used in a manner not specified by the manufacturer, the protection provided by the equipment may be impaired.

The following Warnings, Cautions and Information notifications appear later in this manual where they are applicable.



IF AN ALARM STATE IS TRIGGERED THE USER SHOULD LEAVE THE HAZARDOUS ENVIRONMENT AND ACT IN ACCORDANCE WITH NATIONAL SAFETY REGULATIONS.



THE CLEANING COMPOUND CONTAINS ALUMINIUM OXIDE AS A VERY FINE POWER. THIS MAY CAUSE IRRITATION OF RESPIRATORY TRACT AND EYES. (CAS Number 1344-28-1).



Internal components must be handled with clean hands and clean tools. The lamp is fragile. Handle with great care. Never touch the window and do not drop.



Never refit a damaged Lamp.



The instrument **MUST** be re-calibrated after fitting a replacement or cleaned Lamp.



The FALCO 2 11.7 has been designed to be used in hazardous environments



Important note: Always check the calibration in normal running before use by carrying out a bump test. Apply the same Zero and SPAN gas used to calibrate and ensure the correct readings are displayed.

Disposal

- The equipment does not include any toxic materials, but if it has been contaminated by toxic materials, then exercise due care and follow the appropriate regulations when disposing.
- Always adhere to local regulations and procedures when disposing of the equipment.
- Ion Science Ltd offers a take back service. Please contact us for more information.



RECYCLING

Recycle all Packing.



WEEE REGULATIONS

Ensure that all waste electrical equipment is disposed of correctly.

Certifications

- IECEx Certificate - IECEx FTZU 16.0011X
- ATEX Certificate - FTZU 15 ATEX 0113X

Statements

Responsibility for Correct Use

Ion Science Ltd accepts no responsibility for incorrect adjustments that cause harm or damage to persons or property. The users are responsible to respond appropriately to the readings and alarms given by FALCO 2 11.7.

Use the equipment in accordance with this manual, and in compliance with local safety standards.

Reduced performance of gas detection might not be obvious, so equipment must be inspected and maintained regularly. Ion Science recommends that you use a schedule of regular checks to ensure it performs within calibration limits, and that you keep a record of calibration check data.

Warnings

1. Read and understand this Manual fully before you install or operate the FALCO 2 11.7.
2. For safety, the FALCO 2 11.7 must only be operated by qualified personnel.
3. All electrical work must be only carried out by competent persons.
4. Substitution of components can result in unsafe conditions and will invalidate the warranty.
5. Surface mount fuses must only be replaced by Ion Science service centres.

Introduction

The FALCO 2 11.7 unit is a fixed detector for the continual cyclic monitoring and measuring of volatile organic compounds (VOCs) in the atmosphere. The FALCO 2 11.7 allows for extended VOCs detection over 10.6 eV lamp enabling detection of methanol, formaldehyde, acetylene, and most of the organic compounds with fluorine, chlorine and bromine. VOCs can be dangerous as they are poisonous to humans and there is a risk of explosion. VOCs are detectable using photo ionisation detection (PID) detector.

The FALCO 2 11.7 multi coloured LED status display screen can be seen up to 20 metres away in direct sunlight ensuring that personnel are alerted to hazards present.

The FALCO 2 11.7 has five magnetic switches with LED confirmation, a high contrast OLED screen, and graphical interface ensuring quick and easy installation and servicing.

The magnetic switches are operated with a magnetic actuator that provides the actions of up, down, left, right and enter.

The main display uses organic light emitting diode (OLED) technology and the status bar uses light emitting diodes (LED). It also has a galvanically separated 4-20 mA current loop, Modbus (serial communication protocol) and two configurable switched contacts.

For protection in explosive areas the FALCO 2 11.7 Main Unit electronics are fitted in an ExD enclosure and the PID Sensor Head utilises intrinsically safe electronics.

The FALCO 2 11.7 has two modules:

- The **Main Unit** (flameproof enclosure)
- The **PID Sensor Head** (intrinsically safe)

The externally located, intrinsically safe PID sensor head allows servicing and calibration in a hazardous environment without having to isolate the power supply.

Specification

Specification	Detail
Variant	FALCO 2 11.7 eV (Diffused)
Detector principle	Photo-Ionisation Detector
Lamp	11.7 eV
Sampling	Diffused
Detection Range	0 to 200 ppm
Response time T₉₀	60 seconds (one full cycle)
Accuracy	± 12 % ±1 digit
PID lamp lifetime	Up to 4 months from date of delivery ^[1] ^[2]
Measuring interval	1 min fixed
Calibration points	2 ^[3]
User Interface	
General	Graphical display with backlight, magnetic keys
Display Screen	OLED high contrast white on black
Display Resolution	128 x 64 pixels
Screen Size	35 mm (w) x 17.5 mm (h)
Status Interface	Tri colour (RED, AMBER, GREEN) visible up to 20 meters away
Sensor	
Type	MiniPID2
Sensor certification	ATEX/IECEX: II 1G Ex ia IIC Ga Baseefa 07ATEX0060U
Environmental	
Operating Temperature:	-20 °C to 50 °C (-4 °F to 122 °F)
Operating Humidity:	0 to 99% RH (non-condensing)
Storage Temperature	-40 °C to 60 °C (-40 °F to 140 °F)
Ingress Protection	Main Unit: IP65 Sensor Head: IP65
Electrical	
Nominal Voltage	8 V to 40 VDC (Powered from Safety Extra-Low (SELV))
Maximum Current	1.0 A at 8 V 0.2 A at 40 V
Maximum Power	8 W
Typical Power	2 W (depending on the LED intensity)
Supply Cables	0.5 to 2.5 mm ²
Maximum Contact Load	60 VDC / 2 A 50 VAC / 2 A
Current Loop: Internal Voltage 4-20mA External voltage	19 V ± 1 V / 170 mA 8 V to 28 V
Fuse	Fuse T 1 A (blow value 35 A)
Relay	2 x SPDT (configurable NO & NC options)
Relay Power	60 VDC / 2 A or 50 VAC (2 A max load)
Analogue output	Current loop 4-20 mA and 0-5 mA
Digital interface	RS 485 Modbus

Mechanical Interface	
Dimensions	(Diffused) h 223 mm, w 170 mm, d 115 mm (note: with cable glands, width becomes 192 mm)
Cable glands	M25 x 1.5 Ex D (Cable diameter 13 to 18 mm).
Mounting points	2 x M8
Weight	2.5 kg
General Specification	
Warranty	1 year (standard) 2 years (extended) Lamp 3 months standard warranty from date of sale By ION Science.
EMC	EMC Directive 2014/30/EU
Certification	ATEX/IECEX: II 2G Ex db ib IIC T4 Gb North American Certification - Pending

All specifications quoted are at calibration point and under the same ambient conditions. Specifications are based on isobutylene calibration at 20 °C and 1000 mbar.

^[1] Lamp operation hours may vary depending on application and environmental conditions.

^[2] Four months from date of delivery based on 1 month of storage and 3 months of use

^[3] For optimum product performance and accuracy ION Science recommends that the FALCO 2 11.7eV device is calibrated on a weekly basis.

Unpacking and inspection

All equipment shipped by Ion Science Ltd is packed in containers with shock absorbing filling to protect them against physical damage.

Remove the contents carefully and check them against the packing list. Report discrepancies between the contents and the packing list to Ion Science Ltd. Ion Science will not be responsible for discrepancies not reported within ten days of your receipt of the shipment.

Every FALCO 2 11.7 (new units and those returned from a Service Centre) must have a certificate of calibration before you install it.

Upon removing your new FALCO 2 11.7 from its packing, you should have the following items:

<ul style="list-style-type: none"> FALCO 2 11.7 with MiniPID2 and 11.7 lamp fitted* 	
<ul style="list-style-type: none"> Magnetic Actuator (part no. 873202) 	
<ul style="list-style-type: none"> Calibration adapter (part no. A-873201) 	
<ul style="list-style-type: none"> MiniPID removal tool (part no. 873250) 	
<ul style="list-style-type: none"> 2 x M20 cable entry glands (part no. 28733) 	

*Red flying cable to be removed from instrument before install.

System Description

Outputs and Communications

FALCO 2 11.7 has six communication outputs:

- The on-board LCD and LEDs on the faceplate.
- 4-20 mA Current Loop.
- RS 485 Modbus.
- Two SPDT relays; configurable to operate as Normally Open (NO) or Normally Closed (NC).
- Real-time information from the instrument is displayed on the LCD and transmitted on the 4-20 mA and RS 485 channels.

You can program two alarms to operate at a chosen concentration of gas. The alarms will display a message on the LEDs, energise the relays, and transmit a signal on the 4-20 mA channel.

The alarms and relays are individually programmable to the settings required by the site policy. You can choose either alarm to energise either relay.

Both relays can be programmed to switch 60 VDC / 2 A or 50 VAC / 2 A maximum load.

RS 485 Modbus Interface

The FALCO 2 11.7 Modbus interface uses Modbus RTU

- 9600 baud, 8 data bits, no parity, 1 stop bit.
- Instrument factory default Modbus slave ID: 100.

Register Address	Name	Function Code	Data Type	Range	Register Qty	Comment
102	Gas concentration	3 - Read Holding Registers	32-bit Float	$\pm 1.175494 \times 10^{-38}$ to $\pm 3.402823 \times 10^{+38}$	2	In ppm or mg/m ³ as per instrument setting
106	Sensor Voltage(mV)	3 - Read Holding Registers	32-bit Float	$\pm 1.175494 \times 10^{-38}$ to $\pm 3.402823 \times 10^{+38}$	2	Sensor voltage in mV
108	Temperature (°C)	3 - Read Holding Registers	16-bit Signed Integer	-32768 to +32767	1	sensor VOC temperature in °C x10
182	LED Brightness	3 - Read Holding Registers	16-bit unsigned Integer	0 to 100	1	LED Brightness 0-100%
1005	Measurement Unit	3 - Read Holding Registers	Character	'p' or 'g' (Default value 'p')	1	Units 'p' - ppm; 'g' - mg/m3
1010	Response Factor	3 - Read Holding Registers	32-bit Float	0.1 - 15.00	2	Responds Factor 0,01 to 15.00
1012	Sensor Range	3 - Read Holding Registers	16-bit unsigned Integer	200	1	Read Sensor Range
1060	Span 1 Cal point	3 - Read Holding Registers	16-bit unsigned Integer	0 to 65535*	1	Calibration gas low concentration in ppm x10

*Results that are x10 need to be divided by 10 to convert them to the correct decimal result.

Installation Requirements

Please make sure you understand all the installation requirements and have read the technical specification before you install FALCO 2 11.7.

Location Requirements

There are many variables involved in defining the optimum location for a gas detector.

Mount the FALCO 2 11.7:

- In a location where it is most likely to detect the gas, mindful of the target gases propensity to disperse in ambient atmosphere proportionate to weight.
- In an area that has good air circulation. Restricting natural air current can result in delayed detection.
- On a solid, stable support, where it is accessible for service.
- In a vertical position, with the sensor at the bottom to help avoid rain and dust entering the sensor chamber.
- Not in direct sunlight or over a heat source (this can cause the FALCO 2 11.7 to exceed its certified internal working temperature of 50 °C).
- Not in areas likely to flood.
- In a location that has easy access for servicing.
- For further guidance please consult the relevant local standards or local occupational health representatives.



INFORMATION

- If the VOCs being detected are known to be lighter than air install the FALCO 2 11.7 unit as high on the wall as is practical.
- If the VOCs being detected are known to be heavier than air, install the FALCO 2 11.7 unit as low as possible but never on the floor.

Power Requirements

Nominal Voltage: 8 V to 40 VDC

Cable and Gland Requirements

We recommend you use screened cables e.g., multicore cable with SWA armour, or Braid Armour to protect against EMI.

The cable glands supplied with the FALCO 2 11.7 are EBU2MBNC M25 x 1.5 Ex D (Cable diameter 13 to 18 mm)

The manufacture and build of the cable glands are the responsibility of the installer. The cable glands must conform to the certification standards required for the installation site. Install blanking plugs with the appropriate certification standards to unused cable gland ports.

National Pipe Tapered Thread

For applications that National Pipe Tapered Thread (NPT) ¾ inch is required ION Science recommends the use of the following with certifications for use in Class I/II/III Division 1 and Zone 1,21 (according to international standards such as UL, CSA, ATEX, IECEx):

RST RX744974 (<https://www.rst.eu/en/products/accessories/produkt/erweiterungen-reduzierungen-metall-1/rx744974-1>)

AXIS TQ1917 (<https://www.axis.com/products/axis-tq1917-adapter-m25x15-34-npt>)

NOTE: The external terminal is to be used to ground / earth the FALCO 2 11.7 instrument. The connecting wire must be a minimum of 4 mm².

Installation



INFORMATION

Before installing the FALCO 2 11.7 unit thoroughly read the technical specification contained in this User Manual

Preparation for Installation

Before you install the FALCO 2 11.7, refer to the:

- Instrument User Manual
- Location Requirements
- Power Requirements
- Cable and Gland Requirements
- Dimensions for Installation
- RS 485 Interface Requirements

Dimensions for Installation

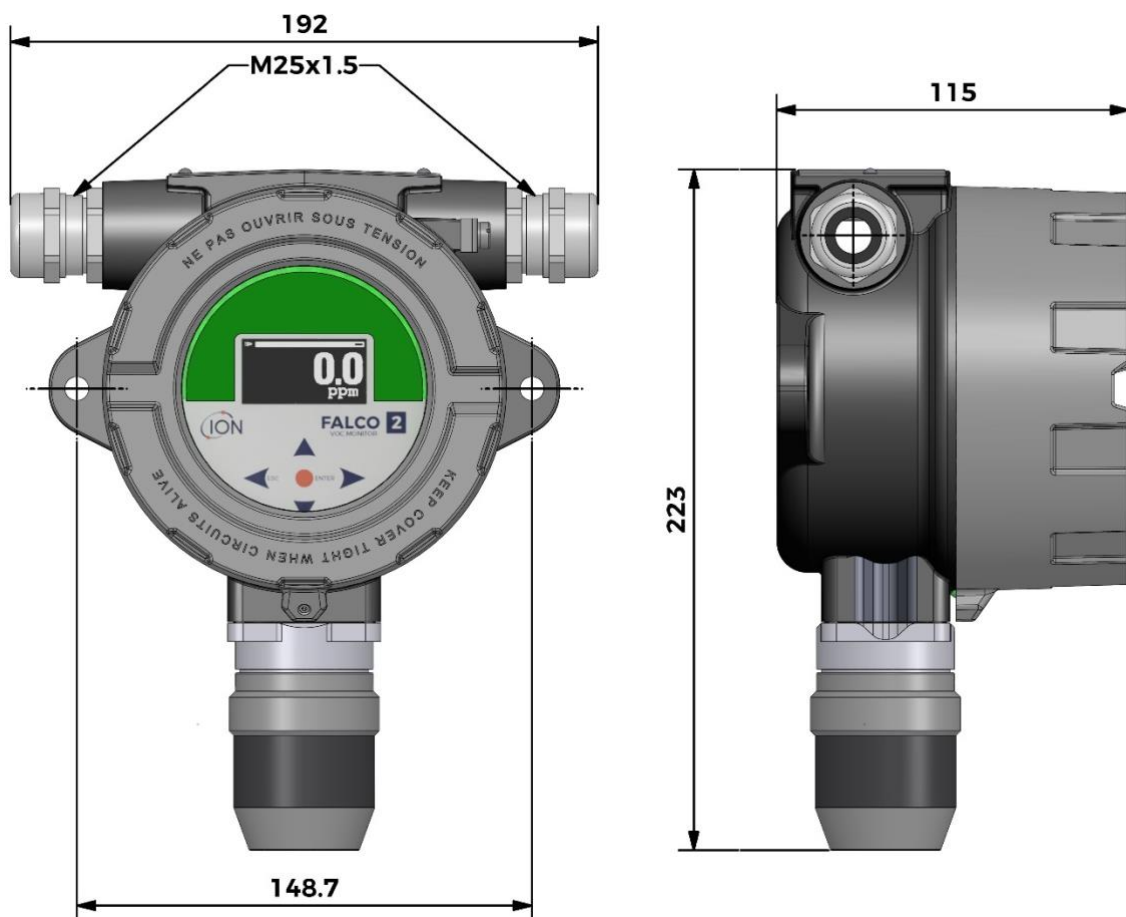

Figure 1 - Dimensional drawing of the FALCO 2 11.7, showing front and side views with key measurements and mounting details

To Install the Housing Module

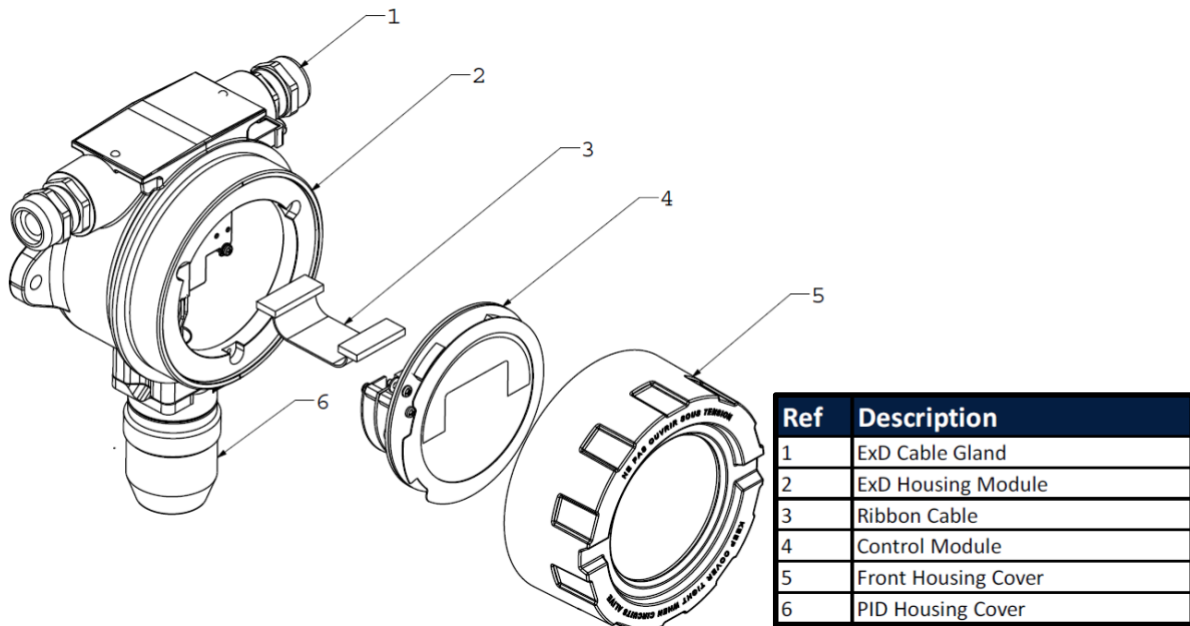

Figure 2 - Exploded view of the FALCO 2 11.7

To install the FALCO 2 11.7 as a complete assembly

1. To ensure secure installation, use two M8 screws to mount the FALCO 2 11.7 (including both the main unit and sensor housing) onto a solid and stable support. Refer to Figure 1 for the device's dimensions and mounting details.
2. After securing the FALCO 2 11.7, unscrew and remove the front housing cover:
 - a. Unbolt the three bolts holding the control module item 4 in Figure 2 from the ExD housing module item 2.
 - b. Disconnect the ribbon cable Figure 2 item 3 from the control module Figure 2 item 4 from its ribbon connector to get access to the terminal blocks.
3. Factory-supplied units include a red Ethernet flying lead, which is for manufacturing purposes only. This lead must be removed before connecting to the terminal blocks and commissioning the instrument.
 - a. Remove and discard the red flying lead before making any terminal block connections.
4. Feed the cables through the ExD cable glands Figure 2 item 1 and connect them to the terminal blocks as required. Refer to the current loop configuration section on the following pages.
5. Secure the cables by tightening the cable glands.
6. Reconnect the control module to the ribbon connector, position it correctly, and tighten the three retaining bolts.
7. Screw the front cover back on securely.
8. Connect and switch on the power supply.
9. Perform an after-installation test.
10. Calibrate the instrument before use.

After-Installation Test

Do a test of the relay and the 4–20 mA systems to check for correct installation and function.

Do a "Bump Test" to verify that the sensors respond correctly to the test gas at the concentrations programmed for Set Points 1 and 2.

A "Bump Test" does not calibrate the sensors. If the instrument does not display the gas concentration given by the bottle, do a calibration to give the correct readings.

Installation in Zones with Explosive Atmospheres

The wiring diagram for the FALCO 2 11.7 is shown below, that covers in input power, MODBUS and Current Loop. There are four possible configurations for the 4–20 mA current loop depending on the installation site that are following section.

Example method of connection for explosive environment:

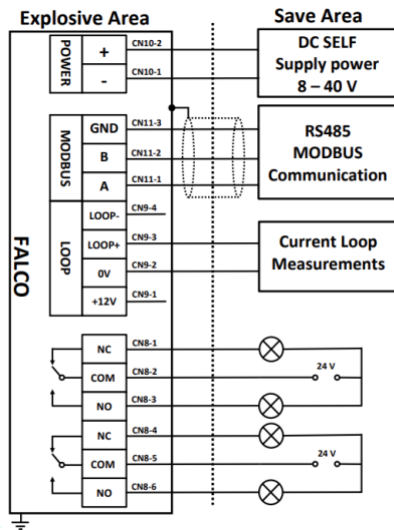
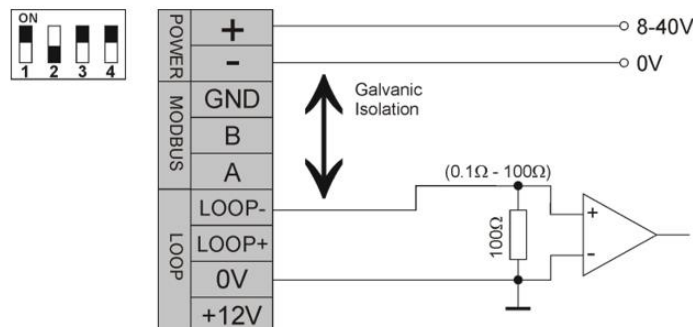

Figure showing typical connector wiring diagram.

Configurations of the 4–20 mA Current Loop

The FALCO 2 11.7 has internal power supply and current source. Depending on the installation site requirements there are several possible configurations. See the following block diagrams and DIP switch settings to suit the application. All configurations are galvanically isolated from the 8 to 40 VDC power supply used to power the FALCO 2 11.7 instrument.

This DIP switch can be found near the ribbon cable and is labelled 4-20 mA LOOP.



FALCO 2 11.7 Current Loop Configuration 1 – active current loop, using internal power supply connected to the current source.

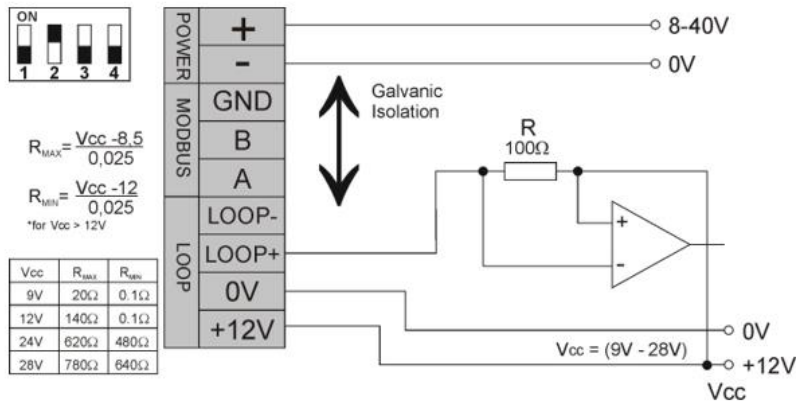

FALCO 2 11.7 Current Loop configuration 2 – passive current loop, externally powered current source.

When using this configuration ensure that the current loop circuit has voltage is between 8.5 V and 12 V, at Loop + after the resistances of the line have been taken into consideration.

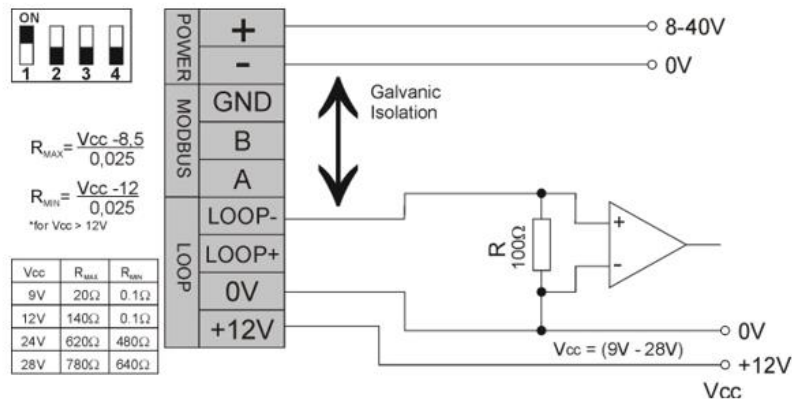

FALCO 2 11.7 Current Loop Configuration 3 – passive current loop, externally powered current source

When using this configuration ensure that the current loop circuit has voltage is between 8.5 V and 12 V, at Loop + after the resistances of the line have been taken into consideration.

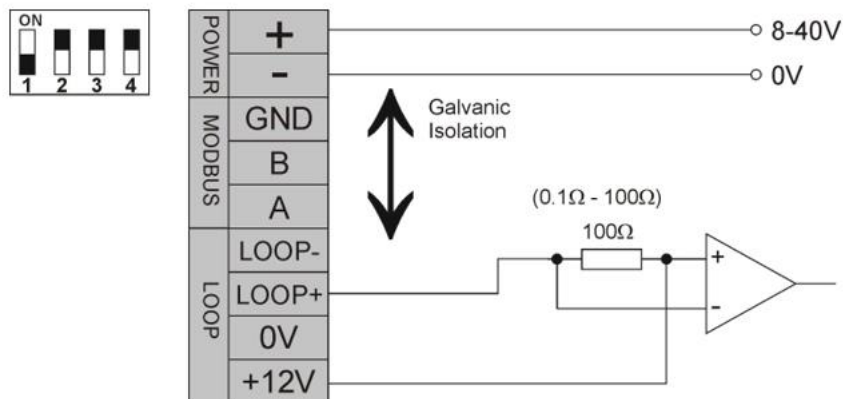

FALCO 2 11.7 Current Loop Configuration 4 – active current loop, using internal power supply connected to the current source.

Duty Cycling Measurement

The FALCO 2 11.7 has been designed with prolonging the lifetime of the 11.7 eV lamp in mind. The unit will sample for 20 seconds every minute as indicated by the lamp icon  in the top left corner. The measurement time how long the device will be taken sample gas from the sample port. During this time, the measurement value is updated at the end of every cycle and shown on the display.

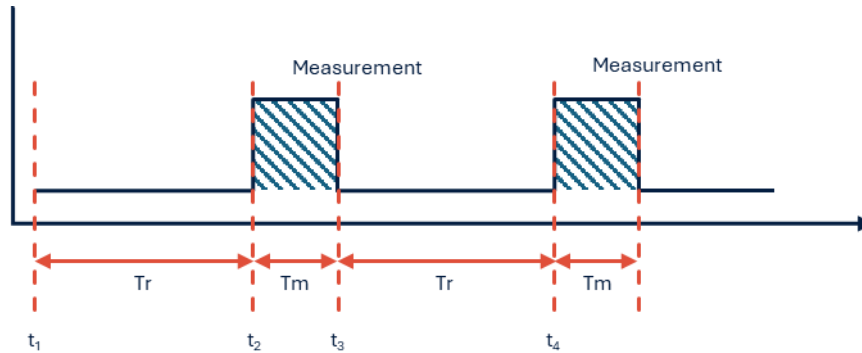

T_m Measure time (fixed at 20 seconds)
 T_r Recovery time (fixed at 40 seconds)

T_1	Begin of recovery phase
T_2	Begin of measurement cycle.
T_3	End of measurement cycle. The final measurement result is shown at the display
T_4	End of recovery phase.

Removal of the Control Module

The removal of the Control Module will only be necessary if the module is no longer required in its detecting position or if there is a module malfunction. The FALCO 2 11.7 range has an externally located intrinsically safe sensor, allowing for quick and easy servicing without the need for a hot work permit. Dual certification allows the FALCO 2 11.7 to be serviced and calibrated in a hazardous environment without having to remove the power.

To Remove the Control Module

CAUTION: This area must be known to be free of flammable concentrations prior opening the enclosure

To remove the FALCO 2 11.7 as a complete assembly:

1. Switch off and isolate the power to the FALCO 2 11.7.
2. Unscrew and remove the Front Cover.
3. Unbolt the three retaining bolts on the Control Module.
4. Disconnect the Control Module from the Ribbon Connector and remove it.
5. Unseal the cables in the cable glands.
6. Disconnect the cables from the terminal blocks and withdraw them from the Housing Module via the cable glands.
7. Make sure that all the electrical connection is either removed or left in a safe, isolated condition.

Operating the FALCO 2 11.7

User Interface



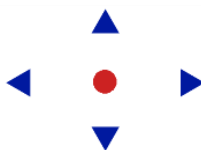

The FALCO 2 11.7 front face has:

- OLED display,
- Keypad - 5 magnetic keys,
- Status Light

Keypad





For easy menu navigation the keypad consists of five magnetic keys **Up, Down, Left, Right** and **Enter**.

Up and Down		Moves the cursor (indicating which screen option is currently selected) and adjusts numeric values and settings up and down.
Left and Right		Moves the cursor left and right and steps between menu screens.
		Left is also used to “escape” settings screens (e.g. exit a menu or sub-menu).
Enter		Used to enter features (e.g. settings screens) and to confirm specified settings.





INFORMATION

The Enter  key, and the Left  key when being used to escape, must be pressed and held briefly to operate them.

The other keys, and the Left key when not been used for escape only need to be tapped.

Status Light

Yellow	Displayed during start-up only, when power is first applied.
Green	Indicates that FALCO 2 11.7 is operating correctly. Also displayed during the start-up routine.
Amber	Flashing amber indicates Alarm 1  has been triggered i.e. the measured level of VOC is above the alarm threshold. Also displayed during the start-up routine.
Red	Flashing red indicates Alarm 2  has been triggered, i.e. the measured level of VOC is above the alarm threshold. Also displayed during the start-up routine.



INFORMATION

The % brightness of the LEDs during normal operation and when alarms are being triggered is configurable.

There are separate settings for both conditions.

Start-Up Routine

When power is applied, the Status Light goes yellow.

The FALCO 2 11.7 will then display the following screens, in this order:

Logo Screen



After the power is turned on, the FALCO 2 11.7 displays the 'Ion Science' logo for 3 seconds and the status light is green.

Info screen 1

Info screen 1 then appears for 3 seconds and the status light goes amber.



It displays the following:

Adr - Modbus address

RF - Response factor

FW – Instrument firmware version

FW – Sensor firmware version

Info screen 2

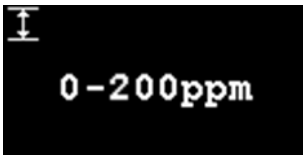

The Info screen 2 then appears for 3 seconds showing the measurement range. The status light goes red.

Warm-up



The warm-up screen then appears, and the screen shows the 30-minute countdown. The status light goes green.



INFORMATION

After switch-on the instrument should be allowed to acclimatise for 30 minutes before working in its 'Normal running mode'.

The warm-up time can be skipped by pressing the **Enter**  key.



WARNING

Warm up period on 11.7 eV doesn't use a duty cycle to stabilise the sensor. Power cycling the unit multiple times and running the warmup will shorten the lifetime over time.

Note: Skipping the warm-up time will skip this stabilisation time.

Normal Operation

The screen then appears continuously and shows the PID reading and units. The Status Light colour depends on the status.

A progress bar showing how far through the current cycle the FALCO 2 11.7 is through the cycle the lamp on is indicated by the lamp icon in the top left corner.



INFORMATION

The hourglass symbol will appear on the screen for the remaining 'warm-up' time if it has been skipped. The brightness of the display will also slowly pulsate to indicate that the warm-up period has been skipped.

Display Overview



Display Menu Navigation

To access the settings menus, press the **Right** ► key from the normal running mode screen. If a passcode has been set, the lock screen will be displayed. Otherwise, the **i1** menu will be displayed. To go back a screen menu to return to the home screen use the **Left** ◀ key.

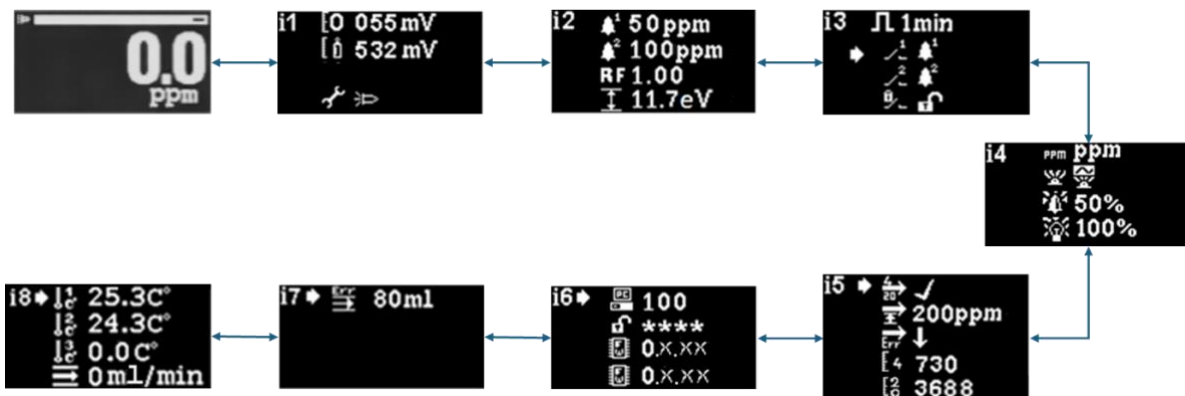

Lock Screen

The Lock screen appears if a password has been set (see menu i6). It prevents unauthorized adjustments, and menus cannot be accessed until the correct password is entered.

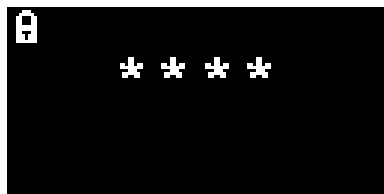

Press the **Enter** ● key. A cursor ▲ is then displayed under the first asterisk. Press the **Up** ▲ or **Down** ▼ key. The asterisk will be replaced by a number. Keep pressing the up and down keys until the first digit of the passcode is displayed.

Press the **Right** ► key to move to the next asterisk. Repeat the above procedure to enter the next digit. Repeat until the four digits of the password are entered.

Press the **Enter** ● key. If the correct password was entered, the **i1** menu will be displayed.

If not, the LED status indicator will change to red. The Lock screen remains displayed, and the user can attempt to enter the password again.



INFORMATION

Entering 4321 at the Lock screen will always enable access to the menus. This can be used if, for example, the actual password has been forgotten.

Navigating the Menus and Selecting Menu Options

There are eight menus: **i1, i2, i3, i4, i5, i6, i7 and i8**.

The eight screens are navigated through using the left and right ◀ ▶ keys on the magnetic keypad. For example, if the **i2** menu is being displayed, press the left ◀ key with the magnetic tool to display the **i1** menu and the right ▶ key to display the **i3** menu.

Each of the menu screens has two or more options on it.

To activate the menus, press the **Enter** ● key this will then show a ▣ cursor displayed next to the first option in the current menu.

To select a menu option, use the **Up** ▲ and **Down** ▼ keys to move the cursor to the required option. To enter the required option, press the **Enter** ● key.

See below for details of all the menus, sub-menus and options.









INFORMATION

If no action is taken in the menu screens for 120 seconds, the display will automatically revert to the Normal Running Mode screen. If a passcode has been set, this must again be entered to access the menus.

Menu i1







This menu displays following options, along with their current settings:

-  **Zero:** Used to set the Zero gas calibration level. The currently set level (in mV) is displayed.
-  **Span 1:** Used to set the Span 1 gas calibration level. The currently set level (in mV) is displayed.
-  **Service / Test mode:** Used to switch to the MiniPID2 sensor in and out of servicing mode. When service mode is selected the power to the MiniPID2 is turned off. The current setting is indicated by a symbol  indicates the MiniPID2 is off,  indicates the MiniPID2 is on. From here you can also put the FALCO 2 11.7 into test mode. This means the FALCO 2 11.7 will simulate its output behaviours. To configure the FALCO 2 11.7 to display a fixed output level, select . To set the FALCO 2 11.7 to output a sawtooth wave, select .





Menu i2

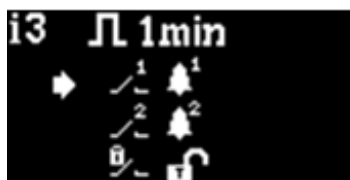

-  **Alarm level 1:** Used to set the ppm level at which Alarm 1 is triggered. The current level is displayed.
-  **Alarm level 2:** Used to set the ppm level at which Alarm 2 is triggered. The current level is displayed.
-  **Measurement range:** Used to view the detection range of the instrument.
-  **Response factor:** Used to set the response factor appropriate for the gas to be detected. The current factor is displayed.





Menu i3



-  **Measurement Cycle:** Fixed one minute duty cycling.
-  **Relay 1 output:** The instrument has two relay outputs, both of which can be triggered by a condition selected by the user. The condition that triggers Relay 1 is selected via the **Relay 1 output** option. A symbol representing the currently selected trigger condition is displayed (see the Relay section for more information).
-  **Relay 2 output:** See above.
-  **Relay Latching:** Configures the relay to be latching.





Menu i4



-  **Detection units:** Used to change the detection units from the default of ppm to mg/m³. The current units are displayed.
-  **PID status light mode:** Used to switch the status light between steady illumination and slow pulsing when alarming. The current setting is indicated by a symbol.
-  **Alarm brightness:** Used to set the brightness of the status light during alarm conditions.
-  **Status Light brightness:** Used to set the brightness of the status light during normal operation.





Menu i5



-  **4-20 mA Enable/Disable:** Used to set the 4 mA to 20 mA output to be active or inactive, as indicated by a tick or a cross.
-  **20 mA range:** Used to set the 20 mA range of the instrument.
-  **4-20 mA fault level:** Used to set whether the fault signal is <4 mA or > 20mA.
-  **4 mA Calibration:** Used to set the 4 mA calibration
-  **20 mA Calibration:** To access the 20 mA calibration setpoint, scroll down using the Down ▼ key. This setting is used to calibrate the 20 mA output.

Menu i6





-  **Modbus address** – Used to select a Modbus slave address.
-  **Password lock** – Used to set the password lock on and off, and to change the password number. The symbol for this option indicates whether the lock is on  or off .
-  **Firmware version** – Displays the current firmware version of the instrument.

Menu i7

The i7 menu is used only for pumped systems to set the flow error setpoint. It is not applicable to FALCO 2 11.7 diffused instruments.



Menu i8

The i8 menu displays the temperature of the internal flow sensor system. The flow temperature  and flow  are only used for pumped systems and defaults to 0, as it is not applicable to FALCO 2 11.7 diffused instruments.



Calibration

The calibration options are accessed from Menu i1



INFORMATION

FALCO 2 11.7 requires 2-point calibration (Zero and Span 1).

For best performance, it is recommended to use a gas concentration near your alarm point. Before starting the calibration process, please ensure you have the following equipment ready for use.

Included parts:



- Magnetic Actuator (part no. 873202)
- Calibration adapter (part no. A-873201)

Additional Equipment required:

- Zero air (UHP Air)
- Span gas (100ppm Isobutylene)
- Suitable tubing to connect gases to FALCO 2 11.7 calibration adapter (part no. A-873201)
- Fixed Flow Regulator (part no. 5/RP-04)

Zero



For best practice ION Science recommend using a cylinder of Zero air with a fixed flow regulator (part no. 5/RP-04) attached with suitable tubing to the calibration adapter (part no. A-873201).



- 1) Enter zero Cal mode by moving the cursor to the zero Cal icon  and then press the Enter  key. The zero Cal screen is described below:



The top value is the live ppm reading from the FALCO 2 11.7 (based on previous calibration)



The bottom number indicates this is the zero Cal screen

- 2) The live reading will move towards zero as the sensor housing is purged. After 2 minutes press the Enter  key to set the zero level.
- 3) The Status Light will then blink briefly to confirm the setting has been made. The top reading will then change to 0.0ppm.
- 4) Remove the Zero air
- 5) Press the  button to exit zero mode.

NOTE: The cursor cannot be moved from next to the “set” symbol . The only function the user can carry out is to press the Enter  key to set the zero level to the current ppm reading.

Span 1



Span 1 is used to calibrate Span 1 of the FALCO 2 11.7:



- 1) Attach the span gas cylinder to the FALCO 2 11.7.
- 2) Enter Span 1 mode by moving the cursor to the Span 1 icon  and then press the Enter  key. The Span 1 screen is described below:





The top value is the live ppm reading from the FALCO 2 11.7 (based on previous calibration)

The lower value is the span 1 concentration (100.7ppm in this example).

If the Span 1 concentration is not the same as the calibration gas concentration it must be changed. To change the Span 1 concentration, move the cursor  to the lower value and press the Enter  key. A new screen with that value is then displayed.

Change this value to match the level specified on the calibration gas bottle as follows. A cursor  is displayed under the first digit of the value. Press the Up  or Down  key to change it.

Press the Right  key to move to the next digit. Repeat the above procedure to change it as required.

Press the Enter  key to return to the previous screen (above). Then move the cursor to the “set” symbol  and apply the gas to the PID sensor. After 2 minutes press the Enter  key. The status light will ‘blink’ briefly to confirm the setting has been changed.

- 3) Remove the span gas cylinder.
- 4) Press the  button to exit span 1 mode.



WARNING

Calibration mode will still operate relays and set the 4-20 mA current to conditions set in calibration mode which may NOT equal current environmental conditions. This can lead to false alarms if precautionary measures are taken into consideration.

RF (Response Factor)

Response factor adjustment is accessed from Menu i2

PIDs are typically calibrated with isobutylene. However, not all VOC have the same response. The difference in response can be accounted for by multiplying the reading by the VOC’s response factor. If a response factor is applied the concentration displayed on the FALCO 2 11.7 will represent the concentration of the VOC.

For example, if the RF is 00.50, and 100ppm is detected based on an isobutylene calibration:

$$100 \text{ ppm} \times 00.50 = 50 \text{ ppm is the value displayed}$$

The default setting for the response factor is 1.

To set a response factor move the cursor to the response factor icon and press the **Enter** key.

A cursor is displayed under the first digit of the value. Press the **Up** or **Down** key to change it.



Set the response factor by moving the cursor and changing the values.

If a factor of higher than 10.00 is entered, when the **Enter** key is pressed, the factor will revert to the default (01.00ppm) and the screen will not exit.

The Modbus will output the calculated value. The 4-20 mA output will not.

The factor can be adjusted from 0.10 to 15.00 in 0.01 increments.

Detection Units

The detection unit options are accessed from Menu i2

Move the cursor to the required units. Press the **Enter** key to save the setting change and return to the **i4** menu. The status light will then blink briefly to confirm the setting has been made.

Press the **Esc** key to return to the **i4** menu without saving the change to the setting.



Used to change the detection units from the default of ppm to milligrams per meter cubed (mg/m³).

The default units are “ppm” and there is an option to display the readings in milligrams per meter cubed (mg/m³). To display the reading in mg/m³ requires a barometric pressure and temperature value. The instrument assumes the fixed values shown below. *

Barometric pressure: 1000 mbar

Temperature: 20 °C

*mg/m³ readings are based on isobutylene as a calibration gas (molecular weight 56.106 g/mol.)

Alarms



The alarm levels are set in menu i2

The FALCO 2 11.7 has 2 alarms levels, 1 and 2. When alarm level 1 is reached the status bar will go amber and Alarm 2 is reached the status bar will go red.

Alarm 1



Used to set the ppm level at which Alarm 1 (amber) is triggered. When accessed, the screen displays the current level.

Set the level as follows. A cursor  is displayed under the first digit of the alarm level. Press the **Up**  or **Down**  key to change it.

Press the **Right**  key to move to the next digit. Repeat the above procedure to change it as required. Repeat until the required value has been entered.

Press the **Enter**  key to save the setting change and return to the **i2** menu. The status light will then blink briefly to confirm the setting has been made.

Note that the instrument will not allow the Alarm 1 level to be set above the Alarm 2 level.

Press the **Esc**  key to return to the **i2** menu without saving the change to the setting.

Alarm 2



Used to set the ppm level at which Alarm 2 (red) is triggered. When accessed, the screen displays the current level.

Set the Alarm 2 level in the same way as described for Alarm 1 above.

Note that the instrument will not allow the Alarm 2 level to be set below the Alarm 1 level.

Alarm 1 will be superseded by the Alarm 2, i.e. if the level of organic compound detected exceeds the Alarm 2 level, that alarm will be triggered instead of Alarm 1 (even though the level will be above the Alarm 1 threshold as well).

Alarm Brightness

Alarm brightness is accessed from menu i4



Used to set the brightness of the Status Light during alarm conditions, from 0 to 100% for green, and 50-100% for amber and red. "AUTO" brightness mode is selected by setting the brightness to 0%

Change the percentage brightness as required.

Alarm brightness may also be set to AUTO mode. Auto mode will measure the ambient light on the face of the instrument and adjust the brightness of the LED's. The LED's will become brighter if the instrument is in high LUX conditions (bright sunshine) and dimmer during low LUX conditions.

While in the screen, the Status Light will change to red and will change brightness in response to change to brightness percentage.

If a brightness of higher than 100% is entered, when the **Enter** ● key is pressed, the factor will revert to the default (100%) and the screen will not exit

Alarm Pulsing

Measurement cycle is accessed from menu i3



Used to switch the LED display between steady illumination and slow pulsing

To change the setting, press the **Up** ▲ or **Down** ▼ key to change the setting. The symbol will change as appropriate:



Steady illumination.



Slow pulsing.

Press the **Enter** ● key to save the setting change and return to the **i3** menu.

Press the **Esc** ◀ key to return to the **i3** menu without saving the change to the setting.

Relays

Relay options are accessed from menu i3

Relay 1 Options



Used to specify which of 4 conditions will trigger the Relay 1 output. Each is represented by a symbol, as described below.

The following conditions may be selected from:



Activate when Alarm 1 is exceeded.



Activate when Alarm 2 is exceeded.



Activate when a fault condition is raised.



Activate for 1 second after the output is updated.

To change the setting, press the **Up** ▲ or **Down** ▼ key to browse through the 4 settings. The symbol will change as appropriate.

Press the **Enter** ● key to save the setting change and return to the **i3** menu.

Press the **Esc** ◀ key to return to the **i3** menu without saving the change to the setting.

Relay 2 Options



Used to specify which of 4 conditions will trigger the Relay 2 output.

See the description of the Relay 1 options setting for details.

4-20 mA

4-20 mA options are accessed from menu i5

4 – 20 mA Enable/Disable



Used to turn the 4 mA to 20 mA output on and off.

To change the setting, press the **Up ▲** or **Down ▼** key to switch between on (tick symbol), and off (cross symbol).

Press the **Enter ●** key to save the setting change and return to the i5 menu.

Press the **Esc ◀** key to return to the i5 menu without saving the change to the setting.

4 - 20mA Range



The lower limit of the 4 mA to 20 mA output range, mapped to 4 mA, is 0 ppm. This option is used to set the upper limit, mapped to 20 mA.

Change the value as required.

Modbus Address

Modbus address setting is accessed from menu i5



Used to select a Modbus slave address.

Change the address number as required, from 1 to 247. The instrument default is address 100.

A unique slave address must be assigned for each Modbus slave device on your network.

Status Light Brightness

The Status Light brightness is accessed in menu i4



Used to set the brightness of the Status Light during alarm conditions, from 0 to 100% for green, and 50-100% for amber and red. "AUTO" brightness mode is selected by setting the brightness to 0%

Change the percentage brightness as required.

Status light brightness may also be set to AUTO mode. Auto mode will measure the ambient light on the face of the instrument and adjust the brightness of the LED's. The LED's will become brighter if the instrument is in high LUX conditions (bright sunshine) and dimmer during low LUX conditions.

While in the screen, the Status Light will change to green (if it wasn't already) and change brightness in response to change to brightness percentage.

If a brightness of higher than 100% is entered, when the **Enter** ● key is pressed, the factor will revert to the default (100%) and the screen will not exit.

Service Mode

The Service Mode allows end-to-end and disabling power to the MiniPID2.

NOTE: Power supplied to the MiniPID2 sensor is not dangerous to the user by either the risk of electrocution or cause a threat of an explosion in a hazardous environment. It is however best practice to remove local power to circuitry when servicing to avoid possible damage by short circuit.

For end-to-end testing the instrument reported as an Alarm through instruments LED status indicator, relays and through the 4-20mA loop whilst displaying current condition on the display (also see relay section for manual overriding of relays).



WARNING

Service mode will still operate relays and set the 4-20 mA current to conditions set in service mode which may NOT equal current environmental conditions. This can lead to false alarms if precautionary measures are taken into consideration.

Service mode is accessed from menu i1

To change the setting, press the **Up** ▲ or **Down** ▼ key to scroll to the spanner icon.

Press the **Enter** ● key to enter the submenu.

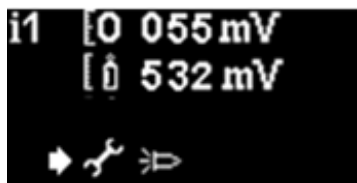



The lamp symbol on the screen indicates whether the sensor service mode is on or off.



If the sensor is in normal mode,  is displayed.

If the sensor is in servicing mode,  is displayed and power to the MiniPID2 is turned off.

If the instrument is in fixed 100 % output test mode,  is displayed.

If the instrument is in oscillating 0 to 100% output test mode,  is displayed.

To change the setting, press the **Up ▲** or **Down ▼** key. The symbol will change as appropriate. Press the **Up ▲** or **Down ▼** key again to reverse the setting.

Press the **Enter ●** key to save the setting change and return to the **i1** menu.

Press the **Esc ◀** key to return to the **i1** menu without saving the change to the setting.



INFORMATION

Alarm levels can be used to trigger relay 1 or relay 2 (see relay section).

Password Lock



Used to set the password lock on and off, and to change the password number.

The current password number will be displayed on the screen. The default value is 0000, which sets the lock to “off”.

Change the password number as required. Use the same method for changing numbers as described previously for the Alarm1 setting.

Changing the number to any number apart from 0000 will set the lock to “on”, with that number as the required password.

Change the password number back to 0000 to turn the lock off again.

Servicing and Maintenance

FALCO 2 11.7 has been designed to ensure servicing is quick and easy.

General maintenance

Ensure the instrument is kept clean, dry and any filters are not blocked. Close all covers when not in use. Instrument leads, adaptors fittings should be checked before use for damage and continuity.

To maintain the reliability of your instrument, regular bump testing is recommended ION Science recommends that the FALCO 2 11.7eV device is calibrated on a weekly basis. This includes checking the functionality of individual components.

Cleaning

Wipe the instrument with a clean cloth dampened with either water or isopropyl alcohol (IPA).

Firmware and Software

Updates Refer to upgrading Firmware and Software at ionscience.com or contact technical.support@ionscience.com for further support.

MiniPID2 Electrode Stack Replacement

NOTE:

1. There are no user replaceable parts within this instrument, other than the MiniPID2 Electrical stack and lamp.
2. Before carrying out any servicing/maintenance on the FALCO 2 11.7, set the device to Servicing Mode.

MiniPID2 stack assembly and removal tools:

Item No	Image	Description	Part Number
1		MiniPID removal tool	873250
2		MiniPID Electrode Stack Removal Tool	846216
3		FALCO 2 Electrode Stack White	A-846627
4		Lamp 11.7eV (FALCO 2)	LA4FW700
5		MiniPID2 6-pin FALCO 2 11.7eV	MP6SX7FWXU2

1. Unscrew the Sensor Cover to access the MiniPID2 located in the Sensor Housing refer to **Error! Reference source not found.** for details.
2. Remove the MiniPID2 using the MiniPID removal tool (PN 873250). Be careful when withdrawing it, don't twist when the MiniPID2 is in the Sensor Housing. Only light force is required.



CAUTION

Do not twist the MiniPID2 while it is within the Sensor Housing.

3. Use the electrode stack removal tool to remove the electrode stack. Hold the MiniPID2 upside down, the Electrode Stack (PN A-846627) and PID Lamp (PN LA4FW700) can then be removed.



CAUTION

Ensure the Electrode Stack (PN A-846627) and PID Lamp (PN LA4FW700) falls onto a soft surface such as a piece of tissue. This will avoid damaging the parts as they fall out and avoids finger contact with the PID Lamp window.

INFORMATION

Contamination of the PID Lamp window can considerably reduce the detection capability of the MiniPID2 (PN MP6SX7FWXU2), even when the contamination is not visible. Maintaining the PID sensor should be carried out on a regular basis depending on the PID Lamp (PN LA4FW700) and the environment.

The humidity of the air and contaminants may affect the time required between servicing.

The Electrode Stack (PN A-846627) should be inspected for visible signs of contamination, if contamination can be seen the Electrode Stack (PN A-846627) must be replaced.

For more information on how to service your MiniPID2 sensor, watch our [tutorial video](#).

MiniPID2 Reassembly

1. Lay the Electrode Stack (PN A-846627) front face down on a clean, flat surface and then screw the lamp (PN LA4FW700) down into the O-ring until it firmly abuts against the front electrode face.
2. Place the MiniPID2 (PN MP6SX7FWXU2) body carefully down over the lamp-stack sub-assembly so as not to disturb its seating within the electrode stack and then push the body firmly onto the face down Electrode Stack (PN A-846627) so that both wings engage with the MiniPID2 (PN MP6SX7FWXU2) body.
3. Inspect the sensor to confirm that both wings of the electrode stack have engaged with the MiniPID2 (PN MP6SX7FWXU2) body.
4. Refit the sensor into the sensing instrumentation.
5. The FALCO 2 11.7 must now be calibrated.

CAUTION

Irreparable damage will be caused by forcing the MiniPID2 (PN MP6SX7FWXU2) into the Sensor Housing if not correctly aligned.

INFORMATION

Always calibrate the FALCO 2 11.7 after completing any servicing.

Replacing the Lamp

CAUTION

Never refit a damaged Lamp.

The instrument **MUST** be re-calibrated after fitting a replacement or cleaned Lamp

Following removal of the electrode stack as described previously.

1. Carefully remove the lamp:
 - a. If the lamp is held in the electrode stack, carefully pull it out of the O-ring around the well in the underside of the electrode stack.
 - b. If the lamp sitting in the sensor body - the Lamp can be gripped and lifted out or the sensor body can be inverted and the lamp tipped out.

2. Discard the removed (old) lamp.
3. Follow MiniPID2 Reassembly instructions to complete the electrode stack assembly and house back into place ready for calibration.

Cleaning the 11.7 eV Lamp



To clean the FALCO 2 11.7 EV lamp, please use anhydrous ethanol or methanol. Contact technical.support@ionscience.com for further support.

Filter Disc Replacement

The Filter Disc (part no. 873210) should be changed after every 100 hours of use, or sooner for particularly dusty or moisture laden environments. To avoid contaminating Filter Discs, they should only be replaced in a clean environment, using clean hands and equipment.

Bump Test

The accuracy of the measurements can be easily checked at any time. ION Science recommends performing a weekly Bump Test on the FALCO 2 11.7 to ensure the instrument responds correctly and that the alarm indicators activate properly when gas is detected at the specified alarm levels. Bump tests should also be conducted whenever these alarm levels are changed.

A calibration is recommended when the instrument response is close to or out of specification to detects and correct deviations, ensuring instruments provide reliable results.

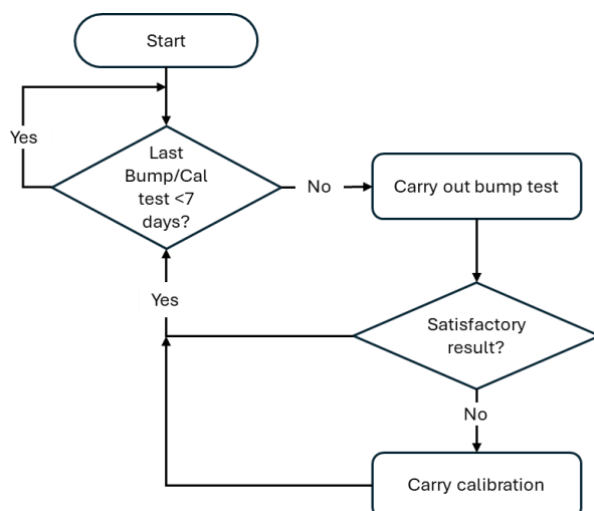

WARNING

Relays and the 4-20 mA current will continue to operate as per normal operation this may NOT equal current environmental conditions. This can lead to false alarms if precautionary measures are taken into consideration.

Before starting the bump test process, please ensure you have the following equipment ready for use.

- Magnetic Actuator (part no. 873202)
- Span gas
- Suitable tubing to connect gases to FALCO 2 11.7 calibration adapter (part no. A-873201)
- Fixed Flow Regulator (part no. 5/RP-04)

Using the Span gas to verify the unit is within satisfactory reading (see specification table for accuracy):

- 1) Attach the span gas cylinder to the FALCO 2 11.7.
- 2) Verify the FALCO 2 11.7 display updates
- 3) If the displayed result is out of specification/satisfactory reading carry out calibration procedure as detailed in Calibration section of this manual.

Fault Diagnostics

Alarm and Fault Indications



Activated when Alarm 1 is exceeded.











Activated when Alarm 2 is exceeded.



Activated when a fault condition is raised.

Fault Conditions

The FALCO 2 11.7 is equipped with diagnostics to ensure instrument faults are detected and communicated. The table gives a fuller description of each fault and lists some possible causes and corrective actions you can try. If the fault continues, or is repeated, contact your Service Centre.

Displayed Fault Screen	Fault Description	Corrective Action
	If the user has exited the initial 30-minute warm up phase, this screen will be displayed for 7 seconds until the lamp has struck.	Wait until the lamp has struck and the instrument displays a reading. If the lamp does not strike replace it.
	The present gas concentration has 'over-ranged' the instrument. The instrument can't display readings greater than 19999 (3000ppm) or 1999.9 (1000ppm) or 199.99 (50ppm) or 19.999 (10ppm).	Wait until gas concentration returns to lower levels and the instrument reading reappears.
	The lamp is not lit during a measurement cycle or PID is not installed.	Replace Lamp or insert PID
	The analogue to digital converter has stopped working.	Contact Service Centre.
	If error 3 occurs, the FALCO 2 11.7 lamp hasn't struck.	Make sure the Sensor Cover is screwed on correctly. Replace lamp if error persists.
	N/A	
	Analogue to digital converter has stopped working.	Contact Service Centre.
	N/A	

Manual Log

Manual Version	Amendment	Issue Date	Instrument (main unit) Firmware	Instrument (Sensor module) Firmware	PC Software
1.0	First Issue	05/03/2025	0.0.37	0.1.14	N/A

Disclaimer: Information in this manual is subject to change without notice and does not represent a commitment on the part of Ion Science. No claims, promises or guarantees are made about the accuracy, completeness, or adequacy of the information contained herein.

Quality Assurance

The FALCO 2 11.7 instruments are manufactured by ION Science Limited within an ISO 9001 compliant quality management system, which ensures that the equipment supplied to our customers has been designed and assembled reproducibly, and from traceable components.

Warranty

Instrument

1 Year standard warranty. To receive your 2 Year Warranty, you must register within one month of purchase (Terms and Conditions apply). You will then receive a confirmation email that your Warranty Period has been activated and processed.

Lamp

3 months standard warranty from date of sale By ION Science.

Full details, along with a copy of our Warranty Statement can be found by visiting: www.ionscience.com

Service

Ion Science recommends a three-month service. This includes replacement of the lamp and stack from the MiniPID2 sensor*.

*Application dependent, this replacement may be required more frequently. Please consult Ion Science or your local representative for more information.

Contact Ion Science or your local distributor for service options in your area.

ION Science Contact Details

ION Science Ltd – UK/Head Office

Tel: +44 (0)1763 208 503

Web: www.ionscience.com | Email: info@ionscience.com

ION Science Inc – USA Office

Tel: +1 877 864 7710

Web: <https://ionscience.com/usa/> | Email: info@ionscienceusa.com

ISM ION Science Messtechnik – Germany Office

Tel: +49 (0) 2104 1448-0

Web: <https://www.ism-d.de/en/> | Email: sales@ism-d.de

ION Science France – France Office

Tel: +33 613 505 535

Web: www.ionscience.com/fr | Email: info@ionscience.it

ION Science Italy - Italy Office

Tel: +39 051 0561850

Web: www.ionscience.com/it | Email: info@ionscience.com

ION Science India - India Office

Tel: +914048536129

Web: www.ionscience.com/in | Email: kschhari@ionscience.com

ION Science China - China Office

Tel: +86 21 52545988

Web: www.ionscience.com/cn | Email: info@ionscience.cn