





ENGLISH

User manual



TABLE OF CONTENTS

1. PRECAUTIONS AND SAFETY MEASURES	2
1.1. Preliminary instructions	2
1.2. During use	3
1.3. After use	3
1.4. Definition of Measurement (Overvoltage) category	3
2. GENERAL DESCRIPTION	4
2.1. Measuring average values and TRMS values	4
2.2. Definition of true root mean square value and Crest factor	4
3. PREPARATION FOR USE	5
3.1. Initial checks	5
3.2. Instrument power supply	5
3.3. Storage	5
4. NOMENCLATURE	6
4.1. Description of the instrument	6
4.1.1. Instrument's initial screen	6
4.2. Description of function keys	7
4.2.1. Key GO/HOLD	7
4.2.2. Key H/H%/H 	7
4.2.3. Key MODE/MXMNPK	8
4.2.4. Keys  /  e  / ZERO	8
4.2.5. Key VTEST/LIM	8
4.2.6. LoZ function	9
4.2.7. AC+DC function	9
4.2.8. Inrush current function (INRUSH)	9
4.2.9. Disabling the Auto Power Off function	9
4.2.10. Setting the full scale for flexible clamp transducer	10
5. OPERATING INSTRUCTIONS	11
5.1. DC voltage measurement	11
5.2. AC, AC+DC voltage measurement	12
5.3. AC, DC, AC+DC voltage with low impedance (LoZ)	13
5.4. Resistance measurement and continuity test	14
5.5. Phase sequence and phase concordance with 1 terminal	15
5.6. Measurement of insulation resistance	17
5.7. Continuity of protective conductors with 200mA	23
5.7.1. Function ZERO – Zeroing of test cable resistance	27
5.8. Measurement of DC, AC, AC+DC, INRUSH current with clamp transducers	29
6. MAINTENANCE	33
6.1. Battery replacement	33
6.2. Cleaning the instrument	33
6.3. End of life	33
7. TECHNICAL SPECIFICATIONS	34
7.1. Technical characteristics	34
7.1.1. General characteristics	36
7.2. Environmental conditions for use	36
7.3. Accessories	37
7.3.1. Standard accessories	37
7.3.2. Optional accessories	37
8. ASSISTANCE	38
8.1. Warranty conditions	38
8.2. Assistance	38
9. THEORETICAL APPENDIXES	39
9.1. Continuity of protective conductors	39
9.2. Measurement of insulation resistance	40
9.2.1. Polarization Index (PI)	43
9.2.2. Dielectric Absorption Ratio (DAR)	43
9.3. Voltage and current harmonics	44

1. PRECAUTIONS AND SAFETY MEASURES

The instrument has been designed in compliance with directive IEC/EN61010-1 relevant to electronic measuring instruments. For your safety and in order to prevent damaging the instrument, please carefully follow the procedures described in this manual and read all notes preceded by symbol  with the utmost attention.

Before and after carrying out measurements, carefully observe the following instructions:

- Do not carry out any measurement in humid environments.
- Do not carry out any measurements in case gas, explosive materials or flammables are present, or in dusty environments.
- Avoid any contact with the circuit being measured if no measurements are being carried out.
- Avoid contact with exposed metal parts, with unused measuring probes, etc.
- Do not carry out any measurement in case you find anomalies in the instrument such as deformation, breaks, substance leaks, absence of display on the screen, etc.
- Pay special attention when measuring voltages higher than 50V, since a risk of electrical shock exists.

In this manual, and on the instrument, the following symbols are used:



Warning: observe the instructions given in this manual; improper use could damage the instrument or its components.



High voltage danger: electrical shock hazard.



Double-insulated meter



AC voltage or current



DC voltage or current



Connection to earth

1.1. PRELIMINARY INSTRUCTIONS

- This instrument has been designed for use in environments of pollution degree 2.
- It can be used for **VOLTAGE** and **CURRENT** measurements on installations with CAT IV 600V, CAT III 1000V to earth and between inputs.
- We recommend following the normal safety rules devised by the procedures for carrying out operations on live systems and using the prescribed PPE to protect the user against dangerous currents and the instrument against incorrect use.
- In case the lack of indication of the presence of voltage may represent a danger for the operator, always carry out a continuity measurement before carrying out the measurement on the live system, in order to confirm the correct connection and condition of the leads.
- Only the leads supplied with the instrument guarantee compliance with the safety standards. They must be in good conditions. If necessary, only replace them with original HT accessories.
- Do not test circuits exceeding the specified voltage limits.
- Do not perform any test under environmental conditions exceeding the limits indicated in § 6.2.1
- Check that the battery is correctly inserted.
- Make sure that the LCD display and the rotary switch indicate the same function.

1.2. DURING USE

Please carefully read the following recommendations and instructions:



CAUTION

Failure to comply with the caution notes and/or instructions may damage the instrument and/or its components or be a source of danger for the operator.

- Before activating the rotary switch, disconnect the test leads from the circuit being measured.
- When the instrument is connected to the circuit being measured, do not touch any unused terminal.
- During current measurement, any other current near the clamps may affect measurement precision.
- When measuring current, always put the conductor as near as possible to the middle of the clamp jaw, to obtain the most accurate reading.
- Do not measure resistance in case external voltages are present; even if the instrument is protected, an excessive voltage may cause malfunction.
- Before attempting any resistance measurement, cut off power supply from the circuit to be measured and make sure that all capacitors are discharged, if present.
- While measuring, if the value or the sign of the quantity being measured remain unchanged, check if the HOLD function is enabled.

1.3. AFTER USE

- When measurement is complete, set the rotary switch to OFF
- If the instrument is not to be used for a long time, remove the batteries

1.4. DEFINITION OF MEASUREMENT (OVERVOLTAGE) CATEGORY

Standard "IEC/EN61010-1: Safety requirements for electrical equipment for measurement, control and laboratory use, Part 1: General requirements", defines what measurement category, commonly called overvoltage category, is. § 6.7.4 reads: Circuits are divided into the following measurement categories:

- **Measurement category IV** is for measurements performed at the source of the low-voltage installation.
Examples are electricity meters and measurements on primary overcurrent protection devices and ripple control units.
- **Measurement category III** is for measurements performed on installations inside buildings.
Examples are measurements on distribution boards, circuit breakers, wiring, including cables, bus-bars, junction boxes, switches, socket-outlets in the fixed installation, and equipment for industrial use and some other equipment, for example, stationary motors with permanent connection to fixed installation.
- **Measurement category II** is for measurements performed on circuits directly connected to the low-voltage installation.
Examples are measurements on household appliances, portable tools and similar equipment.
- **Measurement category I** is for measurements performed on circuits not directly connected to MAINS.
Examples are measurements on circuits not derived from MAINS, and specially protected (internal) MAINS-derived circuits. In the latter case, transient stresses are variable; for that reason, the standard requires that the transient withstand capability of the equipment is made known to the user.

2. GENERAL DESCRIPTION

The instrument carries out the following measurements:

- DC / AC, AC+DC TRMS voltage
- DC / AC / AC+DC TRMS voltage with low impedance (LoZ)
- DC / AC / AC+DC TRMS current with standard clamp transducer
- AC TRMS current with flexible clamp transducers
- Automatic recognition of AC and DC quantities
- Inrush current (Dynamic INRUSH - DIRC)
- Current/voltage harmonics up to the 25th and THD% calculation
- Resistance and Continuity test
- Current and voltage frequency
- Insulation resistance with test voltage 50,100,250,500,1000VDC
- Measurement of Polarization Index (PI) and Dielectric Absorption Ratio (DAR)
- Continuity of protective conductor with 200mA
- Phase sequence with 1 terminal

Each of these functions can be selected by means of the appropriate switch. The instrument is also equipped with function keys (see § 4.2), an analogue bargraph and backlight. The instrument is also equipped with an Auto Power OFF function (which can be disabled), which automatically switches off the instrument 15 minutes after the last time a function key was pressed or the rotary switch was turned. To switch on the instrument again, turn the rotary switch.

2.1. MEASURING AVERAGE VALUES AND TRMS VALUES

Measuring instruments of alternating quantities are divided into two big families:

- AVERAGE-VALUE meters: instruments measuring the value of the sole wave at fundamental frequency (50 or 60 Hz).
- TRMS (True Root Mean Square) VALUE meters: instruments measuring the TRMS value of the quantity being tested.

With a perfectly sinusoidal wave, the two families of instruments provide identical results. With distorted waves, instead, the readings shall differ. Average-value meters provide the RMS value of the sole fundamental wave; TRMS meters, instead, provide the RMS value of the whole wave, including harmonics (within the instruments bandwidth). Therefore, by measuring the same quantity with instruments from both families, the values obtained are identical only if the wave is perfectly sinusoidal. In case it is distorted, TRMS meters shall provide higher values than the values read by average-value meters.

2.2. DEFINITION OF TRUE ROOT MEAN SQUARE VALUE AND CREST FACTOR

The root mean square value of current is defined as follows: *"In a time equal to a period, an alternating current with a root mean square value of 1A intensity, circulating on a resistor, dissipates the same energy that, during the same time, would be dissipated by a direct current with an intensity of 1A"*. This definition results in the numeric expression:

$$G = \sqrt{\frac{1}{T} \int_{t_0}^{t_0+T} g^2(t) dt}$$

The root mean square value is indicated with the acronym RMS.

The Crest Factor is defined as the relationship between the Peak Value of a signal and its

RMS value: $CF (G) = \frac{G_p}{G_{RMS}}$ This value changes with the signal waveform, for a purely

sinusoidal wave it is $\sqrt{2} = 1.41$. In case of distortion, the Crest Factor takes higher values as wave distortion increases.

3. PREPARATION FOR USE

3.1. INITIAL CHECKS

Before shipping, the instrument has been checked from an electric as well as mechanical point of view. All possible precautions have been taken so that the instrument is delivered undamaged.

However, we recommend generally checking the instrument in order to detect possible damage suffered during transport. In case anomalies are found, immediately contact the forwarding agent.

We also recommend checking that the packaging contains all components indicated in § 6.3.1. In case of discrepancy, please contact the Dealer.

In case the instrument should be returned, please follow the instructions given in § 7.

3.2. INSTRUMENT POWER SUPPLY

The instrument is supplied with 4x1.5V alkaline batteries type AAA IEC LR03, included in the package. When batteries are flat, the symbol  is shown on the display. To replace the batteries, see § 6.1.

3.3. STORAGE

In order to guarantee precise measurement, after a long storage time, wait for the instrument to come back to normal condition (see § 6.2.1).

4. NOMENCLATURE

4.1. DESCRIPTION OF THE INSTRUMENT

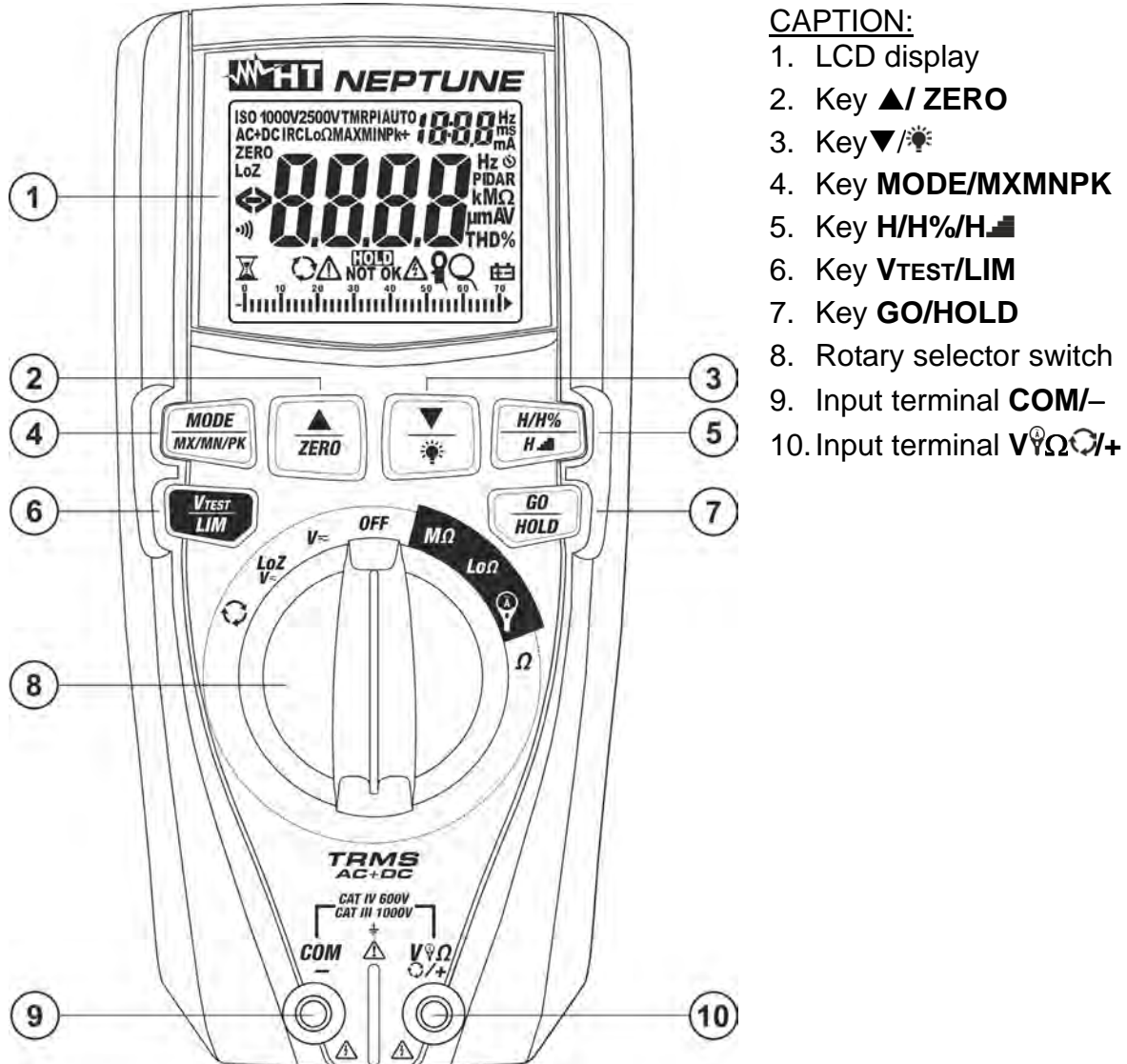

CAPTION:

1. LCD display
2. Key ▲/ZERO
3. Key ▼/☀
4. Key MODE/MX/MN/PK
5. Key H/H%/H
6. Key VTEST/LIM
7. Key GO/HOLD
8. Rotary selector switch
9. Input terminal COM/-
10. Input terminal VΩΩ/+/+

Fig. 1: Description of the instrument

4.1.1. Instrument's initial screen

1. Turn the rotary switch to any position to switch on the instrument. The following initial screen is shown on the display for a few seconds to identify the internal Hardware and Firmware version.



Fig. 2: Instrument's initial screen

2. Turn the rotary switch to **OFF** to switch off the instrument.

4.2. DESCRIPTION OF FUNCTION KEYS

4.2.1. Key GO/HOLD

Pressing the key **GO/HOLD** (for functions V_{\sim} , $LoZV_{\sim}$, Ω and I) makes the instrument hold the value of the quantity shown on the display. The message "HOLD" appears on the display. Press the key again to exit the function. Pressing key **GO/HOLD** (for functions $M\Omega$, $Lo\Omega$, I , I IRC) activates the corresponding measurement.

4.2.2. Key H/H%/H

Key **H/H%/H** (active in positions V_{\sim} , $LoZV_{\sim}$ and I) allows the following operations:

- Simple pressing of the key to display the amplitude of voltage and current harmonics up to the 25th (**Hdc**, **H01... H25**) in absolute or percentage format in relationship with the fundamentals of input signals (for voltage values $V_{AC} > 0.5V$ and current values $AC > 0.5A$ and frequency in the range $42.5Hz \div 69Hz$) and the percentage value of parameter **THD%** (see § 9.3) as shown in Fig. 3. Use keys **▲/ZERO** and **▼/☒** to increase/decrease the order of the harmonic.

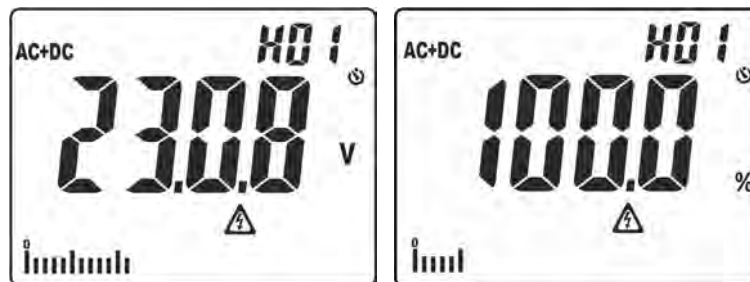

Fig. 3: Display of amplitude of harmonic analysis

- Long pressing of the key (at least 2s) in order to activate the **H₂O** (Higher Harmonic Ordering) ordering function of the amplitude of harmonics. In these conditions, function "HOLD" is automatically activated and symbol "o" appears next to the displayed harmonic order to indicate that the Ordering function is activated. The bargraph is disabled and the instrument shows the value of amplitude of all the harmonics between the DC value and the 25th, fundamental harmonic excluded, in a **decreasing order** starting from the harmonic with the highest amplitude, as shown in Fig. 4

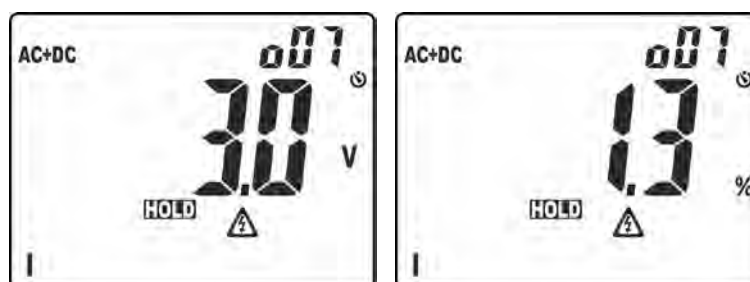







Fig. 4: Display of ordering of amplitude of harmonic analysis

In the example in Fig. 4, the harmonic with the highest value corresponds to the 7th. Press key **▲** to observe the amplitude of the remaining harmonics and press key **H/H%/H** again to switch between display in absolute and percentage values. Turn the rotary switch to exit the function.

4.2.3. Key MODE/MXMNPK





A simple pressing of key **MODE/MXMNPK** allows for the following operations:



- Selection of measuring modes “AUTO”, “AC”, “DC”, “AC+DC” and “FREQ” in positions **V_~**, **LoZV_~**
- Selection of measuring modes “AUTO”, “AC”, “DC” and “AC+DC”, “FREQ” and “IRC” (see § 4.2.8) in position 
- Selection of clamp transducer type in current measurement between options  (optional standard clamp) and “” (optional flexible clamp) in position 
- Selection of measurements “AUTO” “TMR” and “PI” in position **MΩ** (see § 5.6).
- Selection of measurements “AUTO” and “TMR” in position **LoΩ** (see § 5.7).
- Selection of measurement of Resistance “Ω” or Continuity test “” in position **Ω**

A long pressing (>2s) of key **MODE/MXMNPK** allows for the activation/deactivation of continuous detection of maximum value (MAX), minimum value (MIN), positive peak (Pk+), negative peak (Pk-) of the quantity (voltage or current) to be measured. The values are constantly updated and are displayed cyclically every time the same key is pressed. This function is not active in position . Press and hold key **MODE/MXMNPK** (>2s) or use the selector to exit the function.

4.2.4. Keys / e / ZERO

A simple pressing of keys / and / ZERO allows for the following operations::

- Setting of the full scale value of flexible clamp transducer (optional accessory - option “”) in position  among values: **30A, 300A, 3000A** for AC current measurement.
- Setting of the full scale value of standard clamp transducer (option “”) in position  among values: **1A, 10A, 30A, 40A, 100A, 200A, 300A, 400A, 1000A, 2000A, 3000A** for AC and DC current measurement.
- Selection of harmonic order “DC ÷ 25°” in positions **V_~**, **LoZV_~** and 
- Selection of calculation time of RMS value in DIRC function (see § 4.2.8).
- Setting of threshold values in positions **MΩ** and **Lo.Ω**
- Once insulation measurement is complete, the results appear on the display (MΩ, Vgen, PI, DAR).

Long pressing (>2s) of key / allows activating/deactivating display backlight. This function is activated in any position of the rotary switch and is automatically deactivated after approx. 2 minutes' idling. Long pressing (>2s) of key / ZERO allows for the following operations:

- Zeroing of cable resistance in position **LoΩ** (see § 5.7)
- Zeroing of cable resistance in position **Ω** (see § 5.4)

4.2.5. Key VTEST/LIM

A simple pressing of key **VTEST/LIM** allows for the following operations:

- Selecting test voltage in insulation measurement among the following options: **50V, 100V, 250V, 500V, 1000VDC** in position **MΩ**

Long pressing (>2s) of key **VTEST/LIM** allows for the following operations:

- Setting the minimum threshold in insulation measurement among the following options: **no** (no threshold), **0.10MΩ, 0.230MΩ, 0.50MΩ, 1.00MΩ, 100MΩ** in position **M.Ω**
- Setting the maximum threshold for continuity test in range: **0.05Ω ÷ 9.99Ω** in position **Lo.Ω**

4.2.6. LoZ function

This mode allows carrying out AC/DC voltage measurement with a low input impedance, in order to eliminate wrong readings due to parasite voltages for capacitive couplings.



CAUTION

- By plugging the instrument between the phase and earth conductor, because of the low impedance of the instrument during measurement, RCD protections may trip while carrying out the test. If this test is to be carried out, first carry out a measurement of at least 5s between phase and neutral in the presence of voltage
- **Do not leave the instrument connected for more than 1min**

4.2.7. AC+DC function

The instrument is capable of measuring a possible presence of overlapping alternating components on a generic direct waveform (voltage or current). This can be useful when measuring typical impulsive signals of non-linear loads (e.g. welding machines, ovens, etc.).

4.2.8. Inrush current function (INRUSH)

Measurement of inrush current (see § 5.8) is intended as the recognition of an event detected upon exceeding of a trigger threshold. If the instant value exceeds this threshold (**fixed, equal to 1%FS clamp**), the instrument shows on the display the maximum Peak value (calculated in **1ms**) and the maximum RMS value calculated with a time which can be selected among options: **16.7ms, 20ms, 50ms, 100ms (default), 150ms, 175ms and 200ms.**

4.2.9. Disabling the Auto Power Off function

In order to preserve internal batteries, the instrument switches off automatically approximately 15 minutes after it was last used. Press key **MODE/MXMNPK** or turn the rotary switch from position **OFF** to switch on the instrument again. To disable the Auto Power Off function, proceed as follows:

- Switch off the instrument (**OFF**)
- Press and hold key **▲** to switch on the instrument. The symbol “” disappears from the display
- Switch off and then on again the instrument to enable the function.

4.2.10. Setting the full scale for flexible clamp transducer

The instrument can be used with a flexible clamp transducer (optional accessory). For a correct current measurement, it is **necessary** to set the full scale of voltage for the clamp in use (please refer to the transducer's user manual for the correct full scale value to be set). Proceed as follows:

1. Switch off the instrument (**OFF**)
2. Press and hold key **MODE/MXMNPK** and switch on the instrument by turning the rotary switch. The following screen appears on the display:



Fig. 5: Setting the full scale for flexible clamp transducer

3. Press keys ▼/☞ or ▲ to set the full scale value of the clamp in use among the options: **3VAC** (model F3000U) or **1VAC** (other models).
4. Press key **GO/HOLD** to confirm and go back to measuring screen.
5. Settings are maintained every time the instrument is switched on.

5. OPERATING INSTRUCTIONS

5.1. DC VOLTAGE MEASUREMENT

CAUTION



The maximum input DC voltage is 1000V. Do not measure voltages exceeding the limits given in this manual. Exceeding voltage limits could result in electrical shocks to the user and damage to the instrument.

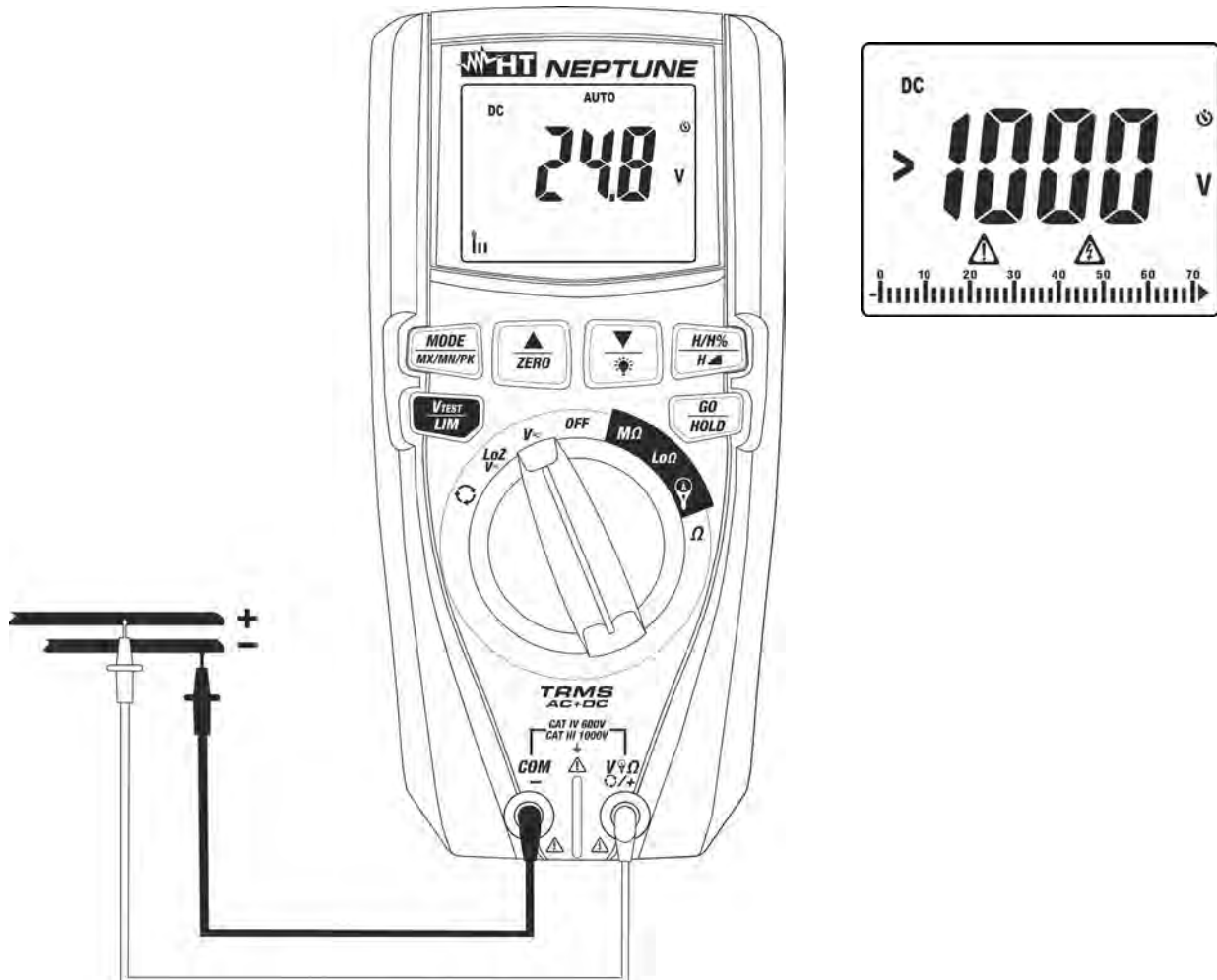

Fig. 6: Use of the instrument for DC voltage measurement

1. Select position V_{\sim}
2. Insert the red cable into input terminal $V_{\sim} \Omega \nabla / +$ and the black cable into input terminal **COM.-**
3. Position the red lead and the black lead respectively in the spots with positive and negative potential of the circuit to be measured (see Fig. 6). The display shows the value of voltage.
4. If the display shows the message "**>1000V**" (see Fig. 6), the maximum measurable value has been reached.
5. When symbol "-" appears on the instrument's display, it means that voltage has the opposite direction with respect to the connection in Fig. 6.
6. To use functions HOLD, MAX/MIN/PK, see § 4.2

5.2. AC, AC+DC VOLTAGE MEASUREMENT
CAUTION

The maximum input AC voltage is 1000V to earth. Do not measure voltages exceeding the limits given in this manual. Exceeding voltage limits could result in electrical shocks to the user and damage to the instrument.

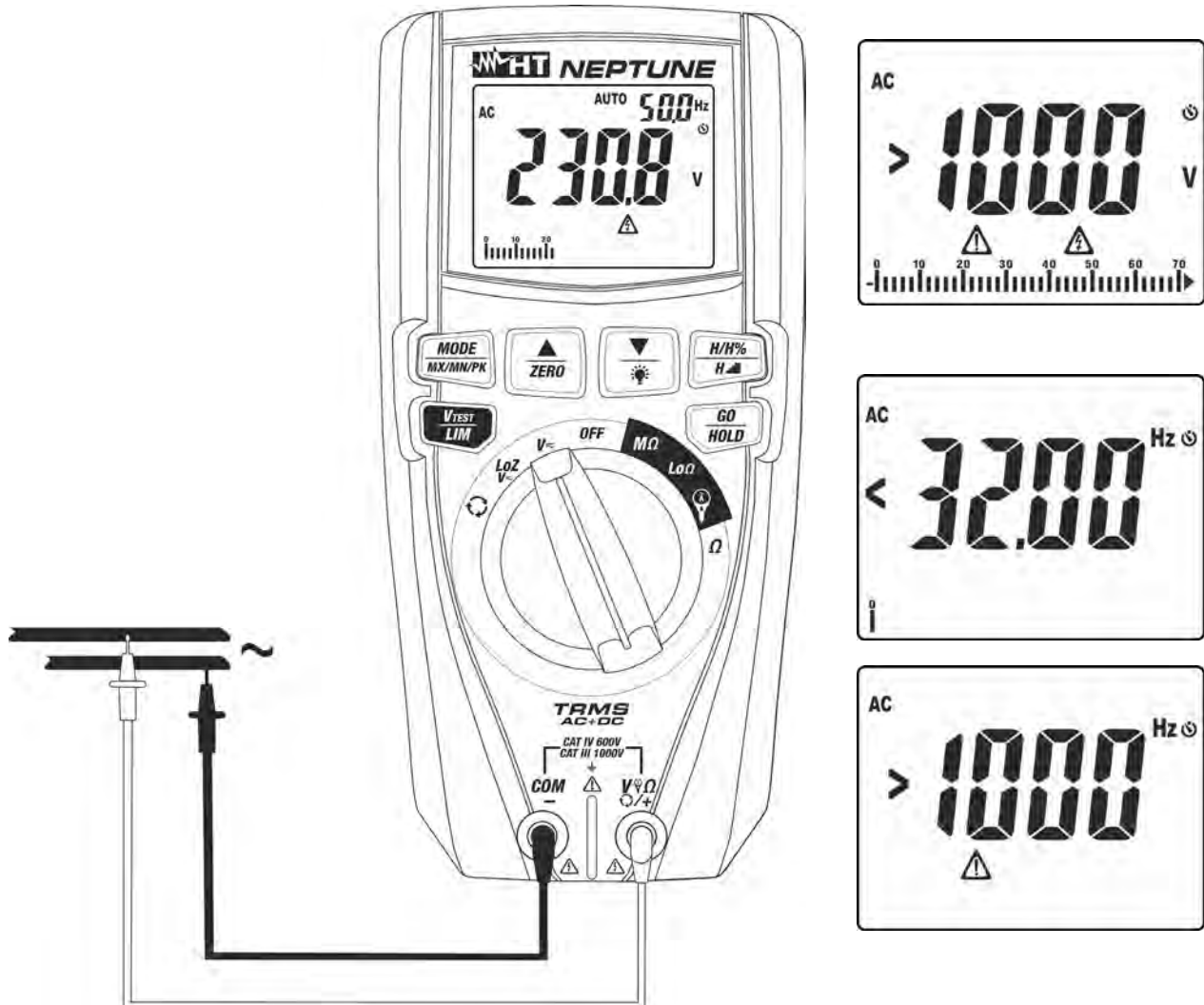

Fig. 7: Use of the instrument for AC voltage measurement

1. Select position V_{\sim}
2. Press the **MODE/MX/MN/PK** key until symbol "AC" or "AC+DC" is displayed. The instrument automatically recognizes AC or DC signals.
3. Insert the red cable into input terminal $V_{\Omega} \text{ } \ominus / +$ and the black cable into input terminal **COM/.**
4. Position the red lead and the black lead respectively in the spots of the circuit to be measured (see Fig. 7). The display shows the value of voltage. On the top of the display on the right side, the value of voltage frequency is displayed. Press key **MODE/MX/MN/PK** to display the value of frequency with a higher resolution.
5. If the display shows the message ">1000V" (see Fig. 7), the maximum measurable value has been reached.
6. If the display shows the messages "<32Hz" or ">1000Hz" (see Fig. 7), the value of frequency is out of the measuring range $32\text{Hz} \div 1000\text{Hz}$.
7. To use functions HOLD, MAX/MIN/PK, H/H%/H, see § 4.2

5.3. AC, DC, AC+DC VOLTAGE WITH LOW IMPEDANCE (LOZ)
CAUTION

The maximum input AC/DC voltage is 1000V to earth. Do not measure voltages exceeding the limits given in this manual. Exceeding voltage limits could result in electrical shocks to the user and damage to the instrument.

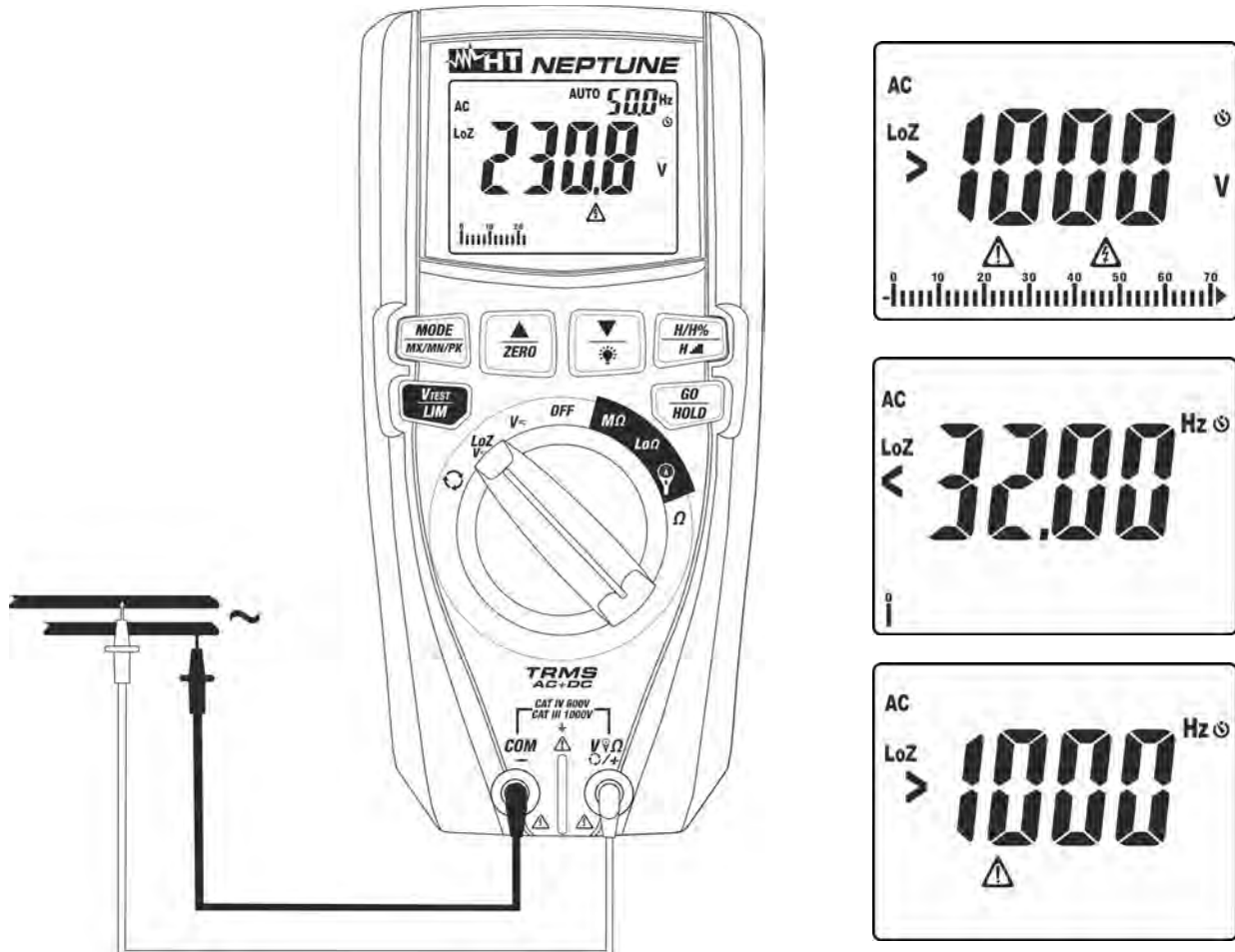

Fig. 8: Use of the instrument for AC/DC voltage measurement with LoZ function

1. Select position **LoZV~**. The symbols "LoZ" and "DC" appear on the display.
2. Press key **MODE/MXMNPK** to select "AC" or "AC+DC" measurement. Anyway, the instrument automatically recognizes AC or DC signals.
3. Insert the red cable into input terminal **V Ω +/+** and the black cable into input terminal **COM/-**
4. Position the red lead and the black lead respectively in the positions of the circuit to be tested (see Fig. 8) for AC voltage measurement or in the positions with a positive or negative potential of the circuit to be tested (see Fig. 6) for DC voltage measurement. The display shows the value of voltage. On the top of the display on the right side, the value of voltage frequency is displayed. Press key **MODE/MXMNPK** to display the value of frequency with a higher resolution.
5. If the display shows the messages "**<32Hz**" or "**>1000Hz**" (see Fig. 8), the value of frequency is out of the measuring range **32Hz ÷ 1000Hz**.
6. When symbol "-" appears on the instrument's display, it means that voltage has the opposite direction with respect to the connection in Fig. 6
7. To use functions HOLD, MAX/MIN/PK, H/H%/H, see § 4.2

5.4. RESISTANCE MEASUREMENT AND CONTINUITY TEST

CAUTION



Before attempting any resistance measurement, cut off power supply from the circuit to be measured and make sure that all capacitors are discharged, if present.

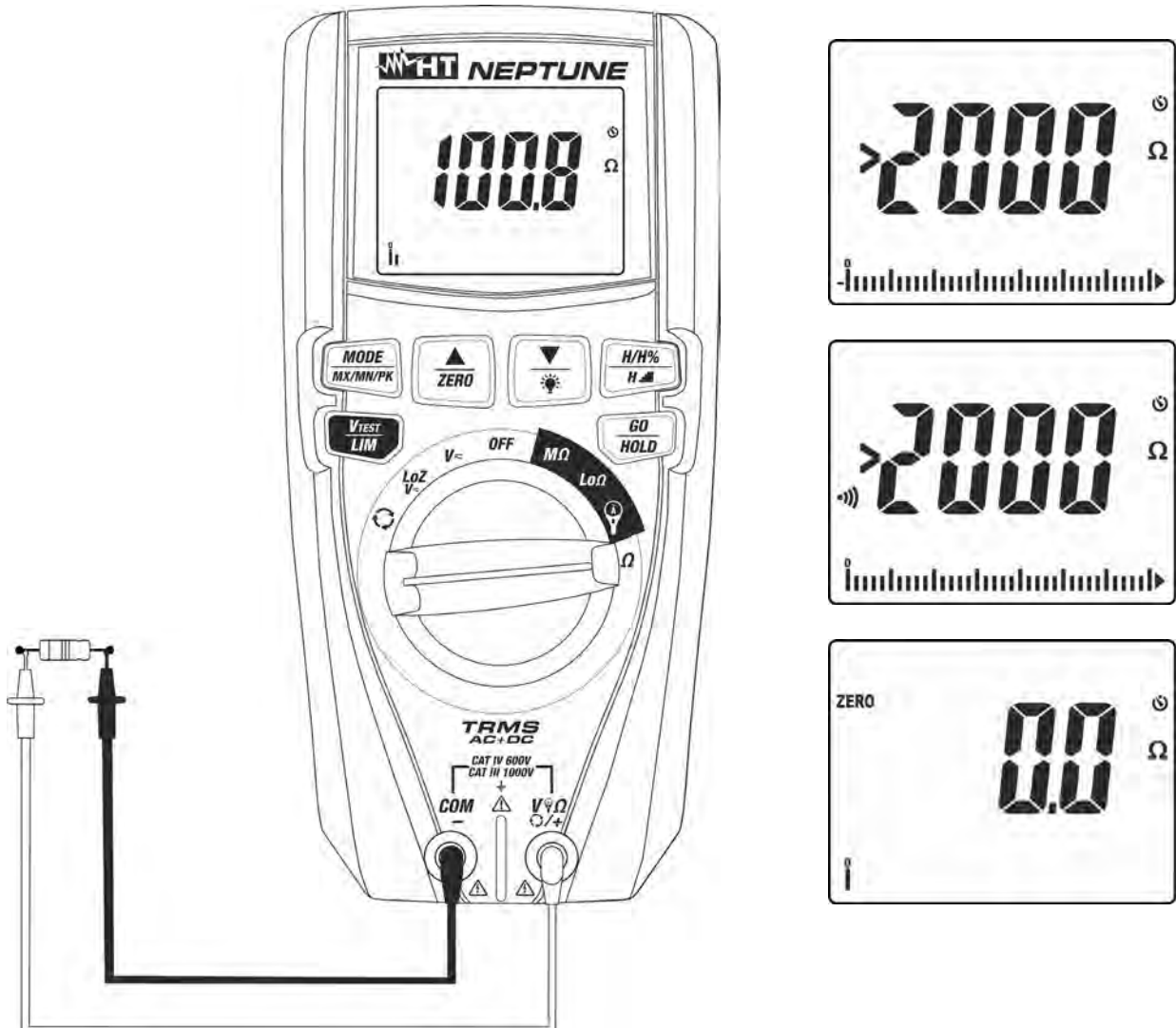

Fig. 9: Use of the instrument for resistance measurement and continuity test

1. Select the position. Ω
2. Insert the red cable into input terminal $V\Omega\text{ } \ominus / +$ and the black cable into input terminal **COM**.–
3. If necessary, short-circuit the measuring leads and press key **▲/ZERO** to zero the resistance of the measuring cables. The symbol “ZERO” appears on the display.
4. Position the test leads in the desired spots of the circuit to be measured (see Fig. 9). The display shows the value of resistance.
5. If the display shows the message “>2000 Ω ” (see Fig. 9) the maximum measurable value has been reached.
6. Press key **MODE/MX/MN/PK** to select “(•)”) measurement, relevant to the continuity test, and position the test leads in the desired positions of the circuit to be measured.
7. The value of resistance (which is only indicative) is displayed in Ω and the instrument sounds if the value of resistance is <30. Ω
8. To use functions HOLD, MAX/MIN, H/H%/H▬, see §. 4.2

5.5. PHASE SEQUENCE AND PHASE CONCORDANCE WITH 1 TERMINAL
CAUTION

- Input AC voltage to carry out this test must be in range **100V ÷ 1000V** with a frequency in range **42.5Hz ÷ 69Hz**.
- This test can only be performed by **touching the metal parts of the conductors**.

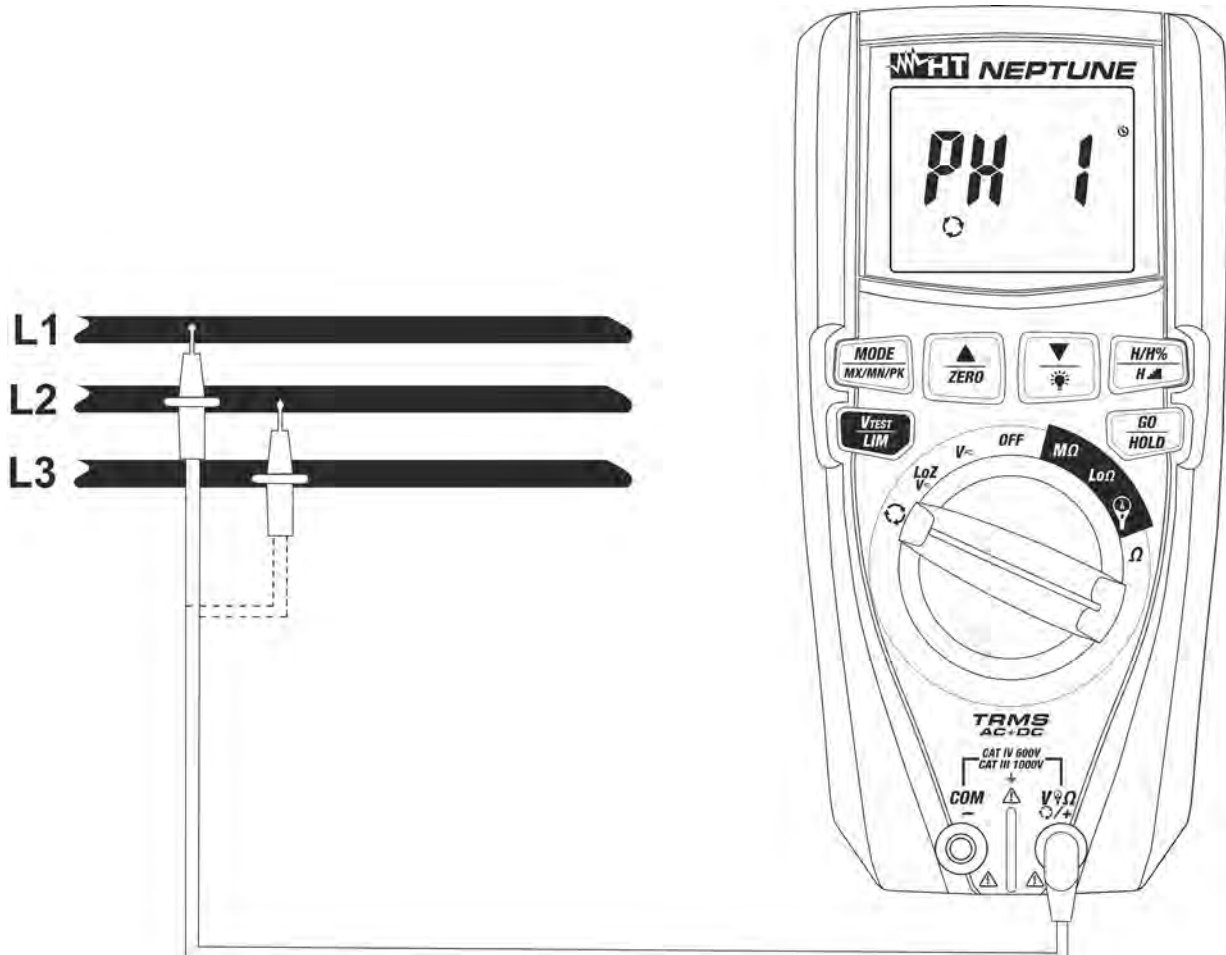

Fig. 10: Use of the instrument for phase sequence and phase concordance test

1. Select position . Message **"PH 1"** flashes on the display.
2. Insert the red lead into input terminal **VΩ /+**.
3. Position the red lead onto phase **L1** of the three-phase system to be tested (see Fig. 10). The following messages may appear on the display (see Fig. 11) to identify the presence of a voltage signal with frequency out of range **42.5Hz ÷ 69Hz**. In these conditions, the instrument does not perform the test.

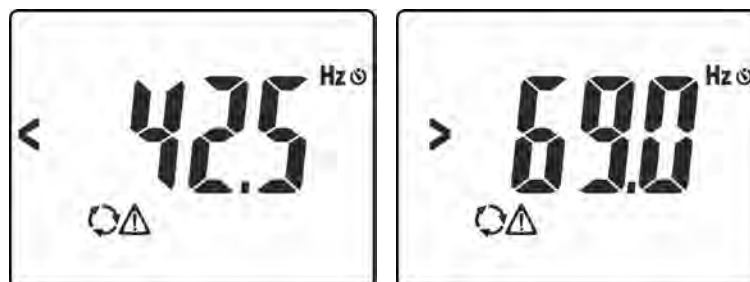

Fig. 11: Signal of voltage with wrong frequency

4. In conditions of correct voltage and frequency, the instrument shows message “**HOLD**”, symbols and “PH1” and the buzzer sounds continuously, waiting for a stable voltage value on phase L1 to be detected (see Fig. 12 – left side).

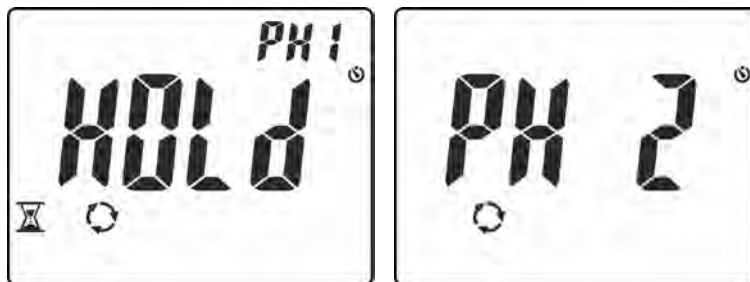

Fig. 12: Detecting phase L1 and waiting for phase L2

5. **Do not remove the lead from phase L1** until message “**PH 2**” appears flashing on the display (see Fig. 12 – right side)

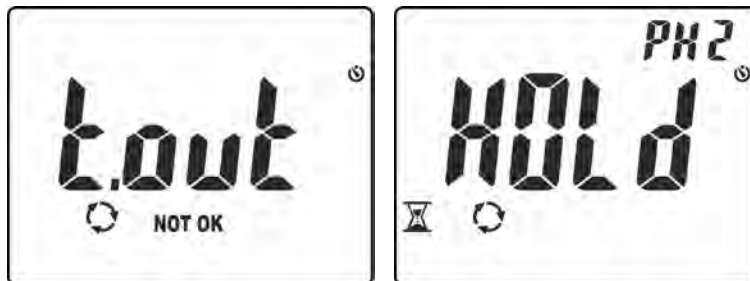

Fig. 13: Detecting phase L1 and waiting for phase L2

6. Position the red lead onto phase **L2** of the three-phase system to be tested (see Fig. 10). In case passage between phase L1 and phase L2 takes more than **10s**, the instrument shows message “**t.out**” on the display (see Fig. 13 – left side). In conditions of correct voltage and frequency, the instrument shows message “**HOLD**”, symbols and “PH2” and the buzzer sounds continuously, waiting for a stable voltage value on phase L2 to be detected (see Fig. 13 – right side).
7. Upon detection of a stable voltage value on phase L2, the instrument automatically shows message “**1.2.3.**” (test OK) or message “**2.1.3.**” (test NOT OK) as shown in Fig. 14



Fig. 14: Results of phase sequence and phase concordance test

8. In case it is necessary to check phase concordance between two parallel three-phase systems, after detection of phase L1 of the first system, position the lead on phase L1 of the second system. The correct final result is message “**1.1-**” (see Fig. 14 – right side)

5.6. MEASUREMENT OF INSULATION RESISTANCE

This function is performed in compliance with standard IEC/EN61557-2 and allows measuring insulation resistance in electric installations and industrial applications where it is necessary to carry out duration tests (see § 9.2). The following operating modes are available:

- **AUTO** the test continues until a stable result is obtained (minimum duration 3s, max 15s) or until key **GO/HOLD** is pressed. Recommended mode
- **TMR** the test is carried out in a continuous mode for the duration (timer) set, among the values: **15s, 30s, 1min, 5min, 10min**
- **PI** the test is carried out in a continuous mode for the duration (timer) set, among the values: **1min, 10min**. If the set time is **1min**, the instrument will display the value of parameter **DAR** (Dielectric Absorption Ratio) (see § 9.2.2). **1min, 10min**. If the set time is **10min**, the instrument will display the value of parameter **PI** (Polarization Index) (see § 9.2.1).

AUTO mode



CAUTION

- Check that the circuit being tested is not live and that all possible loads normally connected to it are disconnected before carrying out insulation measurement.
- We recommend holding the alligator clip respecting the safety area created by the hand protection.

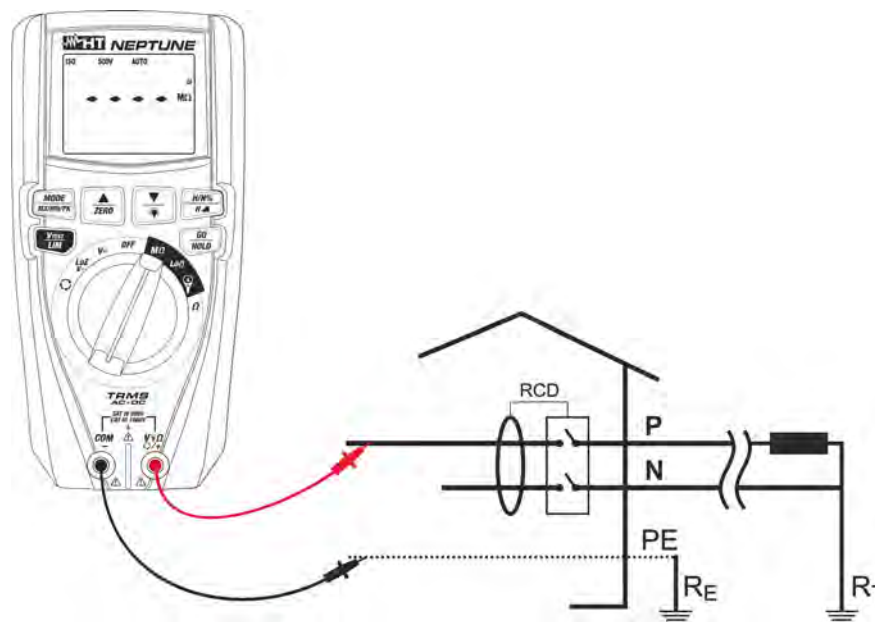

Fig. 15: Use of the instrument for insulation resistance measurement in AUTO mode

1. Select position **MΩ**
2. Press key **MODE/MXMPK** and select option "AUTO"
3. Press key **VTEST/LIM** to set the test voltage choosing among the values: **50V, 100V, 250V, 500V, 1000VDC**. Please note the value in the top part of the display.
4. Press and hold key **VTEST/LIM** (>2s) to set the **minimum** limit threshold for measurement. The symbol "Set" flashes on the display.

5. Press keys ∇/OFF or $\blacktriangle/\text{ZERO}$ to select the value among the options: **0.10M Ω** , **0.230M Ω** , **0.50M Ω** , **1.00M Ω** , **100M Ω** , **no**. Option “no” indicates that no threshold was set (see Fig. 16).

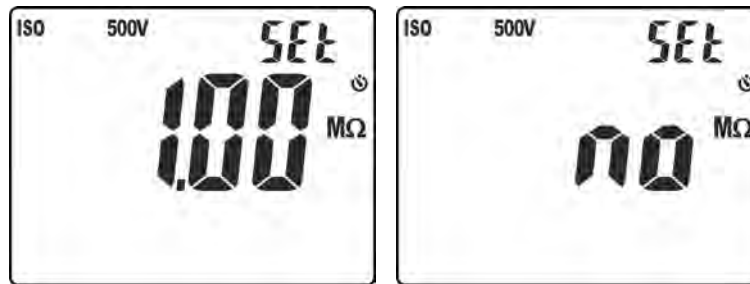

Fig. 16: Setting the limit threshold for insulation measurement

6. Press key **GO/HOLD** to confirm and quit the setting section. The buzzer gives a short continuous sound.
7. Insert the red lead into input terminal **V Ω /+** and the black lead into input terminal **COM/-** and possible alligator clips, and connect the instrument to the system to be tested (see Fig. 15).
8. Press key **GO/HOLD** to activate the test. The following screen may appear on the display to signal the presence of a voltage **>10V** found on the input terminals, preventing the test to be carried out.

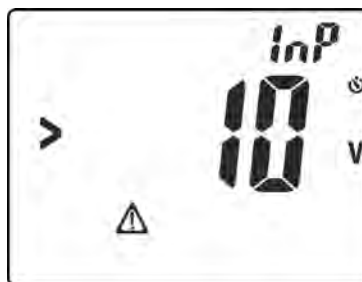

Fig. 17: Presence of voltage on the input terminals

9. In case no anomalous conditions are found, the instrument performs the test until key **GO/HOLD** is pressed and held. Otherwise, the test has a duration of approx. 3s if the key is immediately released, symbol X flashes on the display and the buzzer gives out an intermittent sound. At the end of the test, the following screens appear on the display.

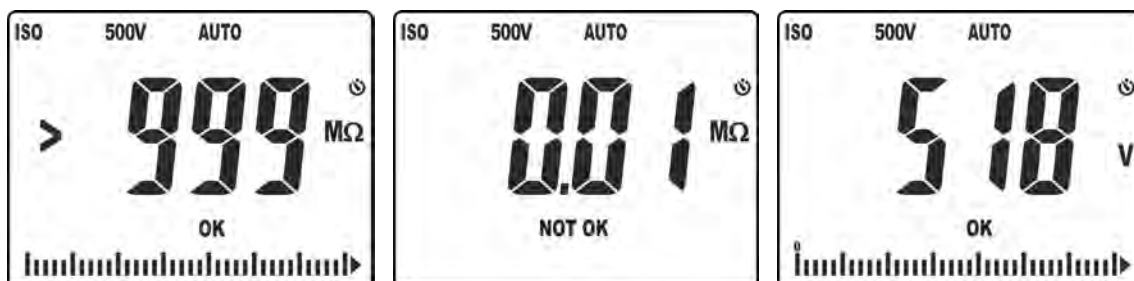

Fig. 18: Results of insulation measurement in AUTO mode

10. In the screen in Fig. 18 – left side, the value of insulation resistance is present (symbol “>999” indicates the out-of-range condition) with positive result “OK” (value higher than the set threshold). In the screen in Fig. 18 – right side, the value of insulation resistance is present with negative result “NOT OK” (value lower than the set threshold).
11. Press keys ∇/OFF or $\blacktriangle/\text{ZERO}$ to display the real applied voltage.

TMR mode



CAUTION

- Check that the circuit being tested is not live and that all possible loads normally connected to it are disconnected before carrying out insulation measurement.
- We recommend holding the alligator clip respecting the safety area created by the hand protection.

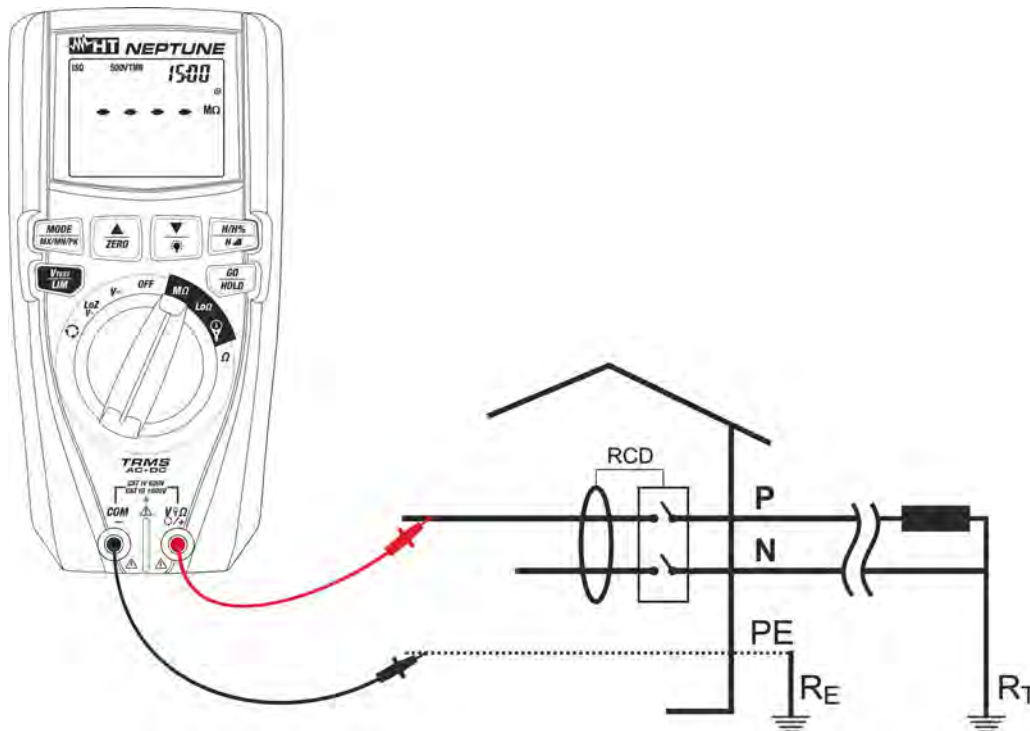

Fig. 19: Use of the instrument for insulation resistance measurement in TMR mode

1. Select position **MΩ**
2. Press key **MODE/MXMPK** and select option “TMR”
3. Press key **VTEST/LIM** to set the test voltage choosing among the values: **50V, 100V, 250V, 500V, 1000VDC**. Please note the value in the top part of the display.
4. Press and hold key **VTEST/LIM** (>2s) to set the **minimum** limit threshold for measurement. The symbol “Set” flashes on the display. Press keys **▼/⚡** or **▲/ZERO** to select the value among the options: **0.10MΩ, 0.230MΩ, 0.50MΩ, 1.00MΩ, 100MΩ, no**. Option “no” indicates that no threshold was set (see Fig. 16).
5. Press keys **▼/⚡** or **▲/ZERO** to select the measuring time (timer) choosing among the options: **15s, 30s, 1min, 5min, 10min**. Please note the value in the top part of the display on the right (see Fig. 20).

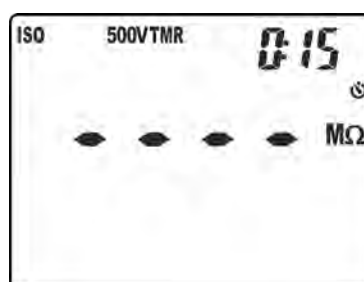

Fig. 20: Setting the measuring time in TMR mode

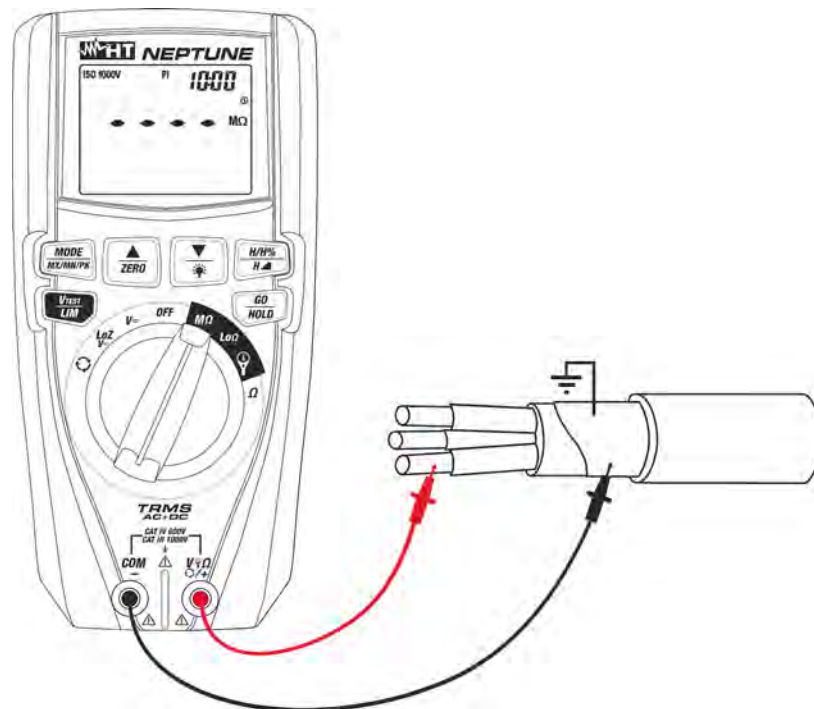

Fig. 22: Use of the instrument for insulation resistance measurement in PI mode

1. Select position **MΩ**
2. Press key **MODE/MXMNPK** and select option “PI”
3. Press key **VTEST/LIM** to set the test voltage choosing among the values: **50V, 100V, 250V, 500V, 1000VDC**. Please note the value in the top part of the display.
4. Press and hold key **VTEST/LIM** (>2s) to set the **minimum** limit threshold for measurement. The symbol “Set” flashes on the display. Press keys **▼/☒** or **▲/ZERO** to select the value among the options: **0.10MΩ, 0.230MΩ, 0.50MΩ, 1.00MΩ, 100MΩ, no**. Option “no” indicates that no threshold was set (see Fig. 16).
5. Press keys **▼/☒** or **▲/ZERO** to select the measuring time (timer) choosing among the options: **1min** (for DAR measurement) or **10min** (for PI measurement). Please note the value in the top part of the display on the right (see Fig. 20).
6. Insert the red lead into input terminal **VΩΩ/+/+** and the black lead into input terminal **COM/-** and possible alligator clips, and connect the instrument to the appliance to be tested (see Fig. 22).
7. Press key **GO/HOLD** to activate the test. The screen in Fig. 17 may appear on the display to signal the presence of a voltage **>10V** found on the input terminals, preventing the test to be carried out.
8. In case no anomalous conditions are found, the instrument performs the test in a continuous mode with a countdown of time (until time “0:00”) for the entire duration of the set timer, symbol **⏸** flashes on the display and the buzzer gives out an intermittent sound. At the end of the test, the following screens appear on the display.

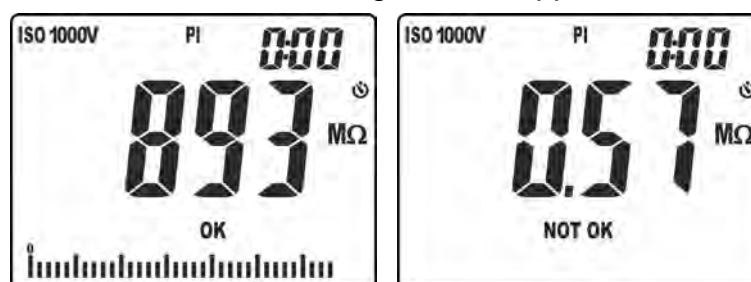

Fig. 23: Results of insulation measurement in PI mode

9. In the screen in Fig. 23 – left side, the value of insulation resistance is present at the end of measurement with positive result “OK” (value higher than the set threshold). In the screen in Fig. 23 – right side, the value of insulation resistance is present at the end of measurement with negative result “NOT OK” (value lower than the set threshold).
10. Press keys ▼/☼ or ▲/ZERO to display the real applied voltage, the value of parameter PI or the value of parameter DAR (see Fig. 24).

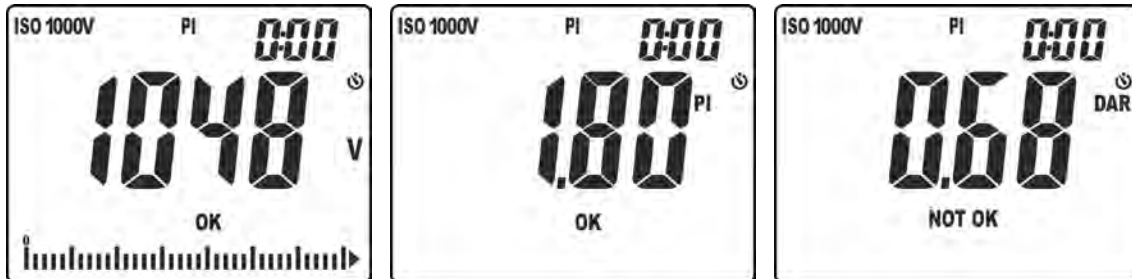

Fig. 24: Results of PI and DAR measurements

5.7. CONTINUITY OF PROTECTIVE CONDUCTORS WITH 200mA

This function is performed in compliance with standard IEC/EN61557-4 and allows measuring the continuity of protective and equipotential conductors. The following operating modes are available:

- **AUTO** the test is activated by pressing key **GO/HOLD** and the result is immediately displayed after comparing it with the set maximum threshold value. Recommended mode
- **TMR** the test is carried out in a continuous mode for the duration (timer) set in range **1s ÷ 30s**, and the result is shown on the display after comparing it with the set maximum threshold value.
- **ZERO** compensation of the resistance of the cables used for measurement. The instrument automatically subtracts the value of cable resistance from the measured resistance value. It is therefore necessary that this value is measured (by means of the **ZERO** function) each time the test cables are changed or extended.

AUTO mode



CAUTION

- Check that the circuit being tested is not live and that all possible loads normally connected to it are disconnected before carrying out insulation measurement.
- The continuity test is performed by supplying a current higher than 200mA for resistances not higher than **5Ω** (including the resistance of the measuring cables). For higher resistance values, the instrument carries out the test with a current lower than 200mA.

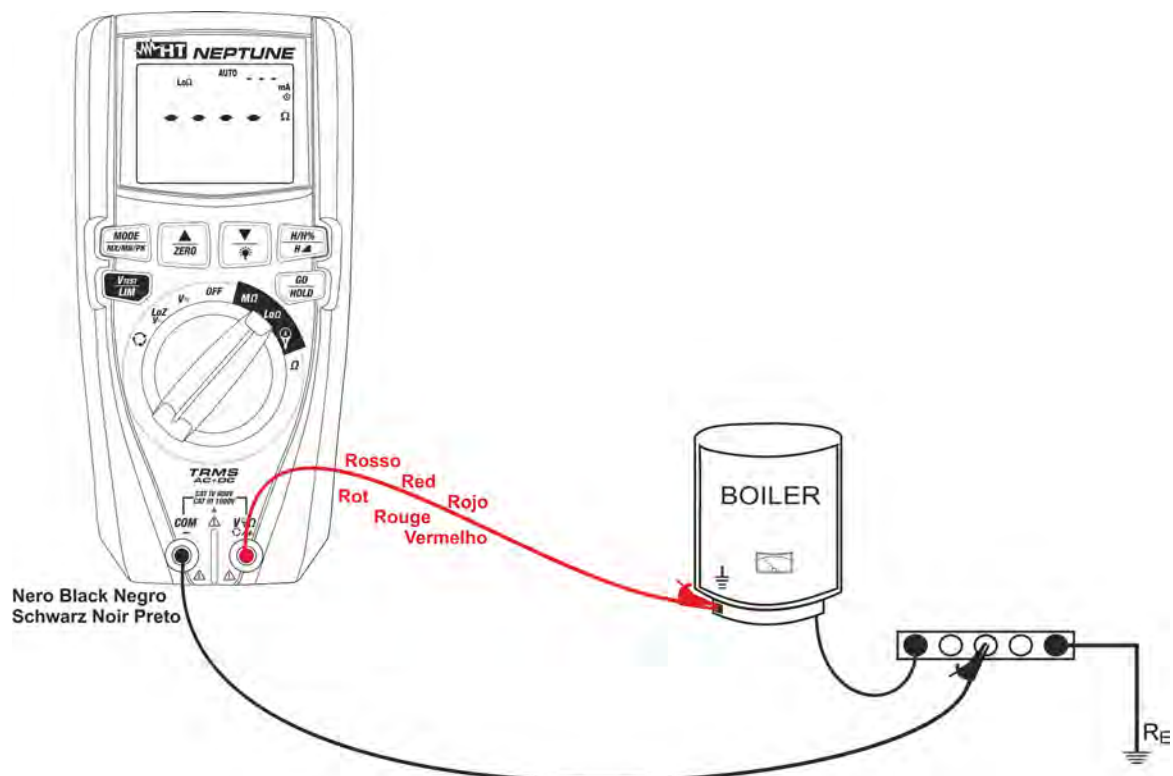

Fig. 25: Use of the instrument for continuity test in AUTO mode

1. Select position **Lo Ω**
2. Press key **MODE/MXMNPK** and select option "AUTO"
3. Press and hold key **VTEST/LIM** (>2s) to set the **maximum** limit threshold for measurement. The symbol "Set" flashes on the display.
4. Press keys **▼/☼** or **▲/ZERO** to select the value in the range: **0.05 Ω ÷ 9.99 Ω** (see Fig. 26).



Fig. 26: Setting the limit threshold for continuity test

5. Press key **GO/HOLD** to confirm and quit the setting section. The buzzer gives a short continuous sound.
6. If necessary, compensate the test cables (see § 5.7.1).
7. Insert the red lead into input terminal **V Ω +** and the black lead into input terminal **COM/-**, and connect the instrument to the system to be tested (see Fig. 25).
8. Press key **GO/HOLD** to activate the test. The following screen may appear on the display to signal the presence of a voltage **>10V** found on the input terminals, preventing the test to be carried out.

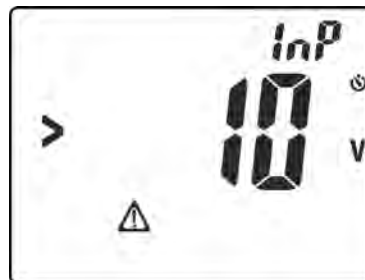

Fig. 27: Presence of voltage on the input terminals

9. In case no anomalous conditions are present, the instrument carries out the test and symbol \boxtimes flashes on the display. At the end of the test, the following screens appear on the display.



Fig. 28: Results of continuity test in AUTO mode

10. In the screen in Fig. 28 – left side, a positive test result "OK" is shown (value lower than the set threshold and test current >200mA). In the screen in Fig. 28 – middle, a negative test result "NOT OK" is shown (value higher than the set threshold and test current <200mA). In the screen in Fig. 28 – right side, a negative test result "NOT OK" is shown, corresponding to the out-of-range condition (symbol ">200.0").

TMR mode



CAUTION

- Check that the circuit being tested is not live and that all possible loads normally connected to it are disconnected before carrying out insulation measurement.
- The continuity test is performed by supplying a current higher than 200mA for resistances not higher than 5Ω (including the resistance of the measuring cables). For higher resistance values, the instrument carries out the test with a current lower than 200mA.

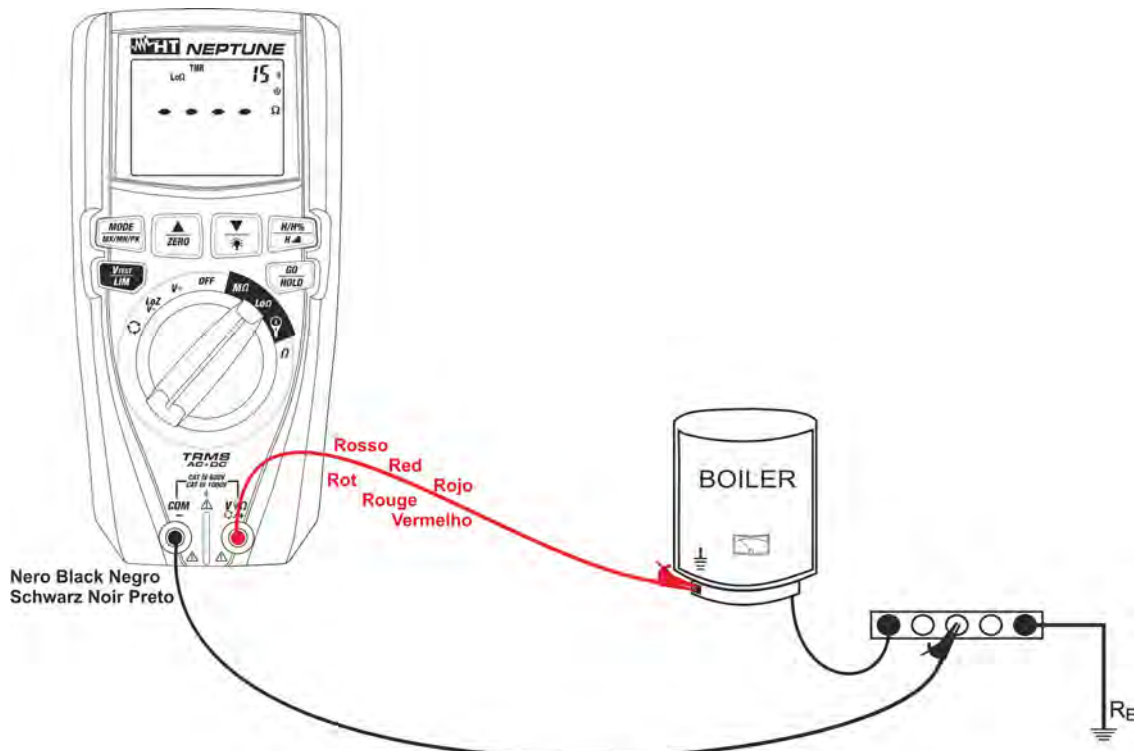

Fig. 29: Use of the instrument for continuity test in TMR mode

1. Select position **LoΩ**
2. Press key **MODE/MXMNPK** and select option "TMR"
3. Press and hold key **VTEST/LIM** (>2s) to set the **maximum** limit threshold for measurement. The symbol "Set" flashes on the display.
4. Press keys **▼/☼** or **▲/ZERO** to select the value in the range: **0.05Ω ÷ 9.99Ω** (see Fig. 26).
5. Press keys **▼/☼** or **▲/ZERO** to select the measuring time (timer) in range: **1s ÷ 30s**. Please note the value in the top part of the display on the right (see Fig. 30).

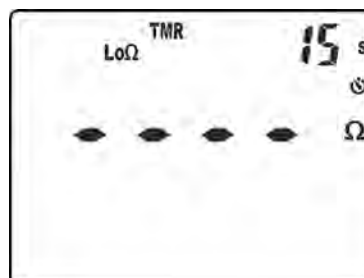

Fig. 30: Setting the measuring time in TMR mode

6. If necessary, compensate the test cables (see § 5.7.1).
7. Insert the red lead into input terminal $V\Omega\ominus/+$ and the black lead into input terminal **COM**/–, and connect the instrument to the system to be tested (see Fig. 29).
8. Press key **GO/HOLD** to activate the test. The screen in Fig. 27 may appear on the display to signal the presence of a voltage $>10V$ found on the input terminals, preventing the test to be carried out.
9. In case no anomalous conditions are found, the instrument performs the test in a continuous mode with a countdown of time (until time “0”) for the entire duration of the set timer, and symbol Σ flashes on the display. At the end of the test, the following screens appear on the display:

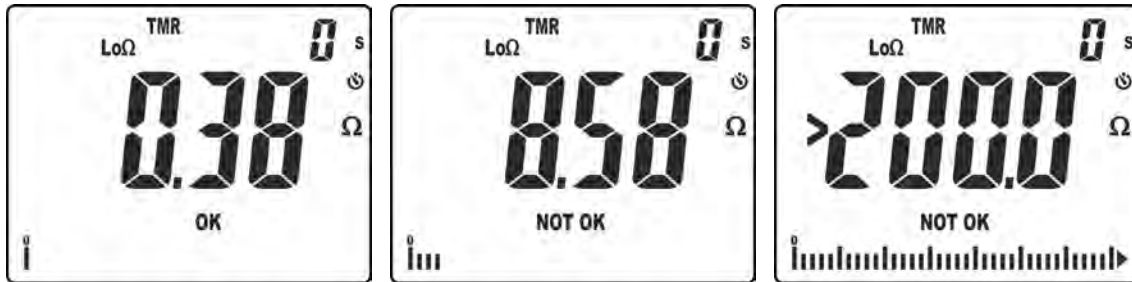

Fig. 31: Results of continuity test in TMR mode

10. In the screen in Fig. 31 – left side, a positive test result “OK” is shown (value lower than the set threshold and test current $>200mA$). In the screen in Fig. 31 – middle, a negative test result “NOT OK” is shown (value higher than the set threshold and test current $<200mA$). In the screen in Fig. 31 – right side, a negative test result “NOT OK” is shown, corresponding to the out-of-range condition (symbol “ >200.0 ”).

5.7.1. Function ZERO – Zeroing of test cable resistance

In every operating mode (AUTO, TMR) it is possible to zero the resistance of the test cables before carrying out continuity tests. This operation is recommended upon the first use of the provided test cables and in case different cables must be used (e.g. cable extensions). **The operation is only possible for test cable resistance <math><5.00\Omega</math>.**

1. Select position **Lo Ω**
2. Insert the test cables into input terminal **V Ω /+/+** and **COM/-**, connect the alligator clips and short-circuit the cable ends between each other (see Fig. 32).

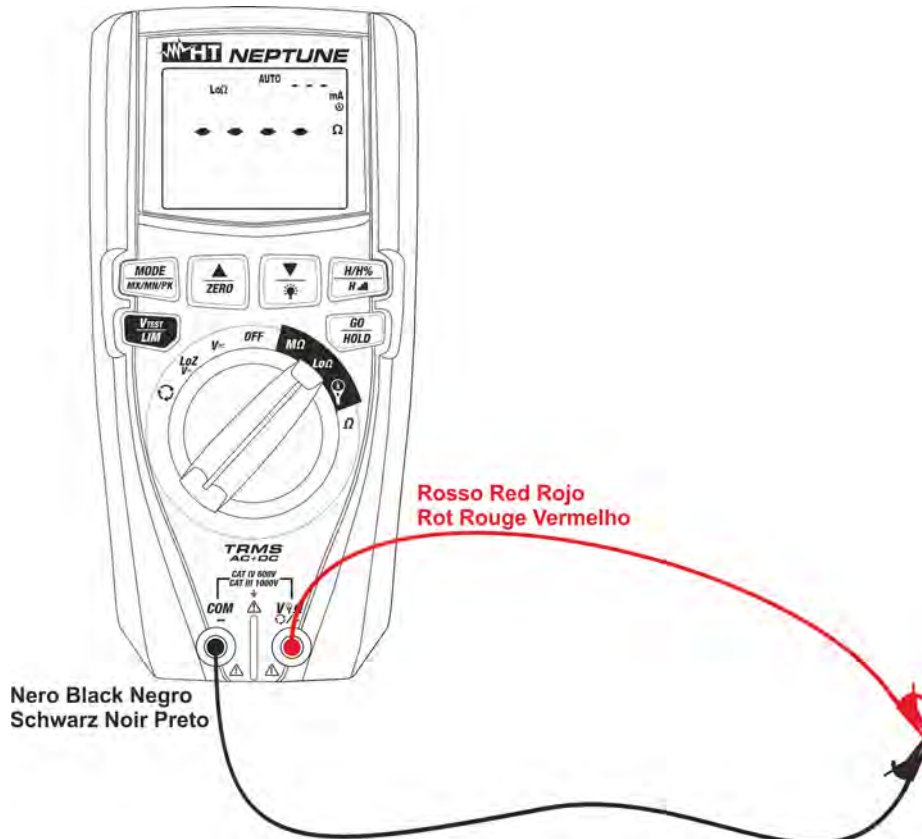

Fig. 32: Connection of the cables in compensation function

3. Press and hold (>2s) key **▲/ZERO**. The instrument starts the compensation procedure of cable resistance, immediately followed by the verification of the compensated value. The following screens are displayed in a quick sequence:

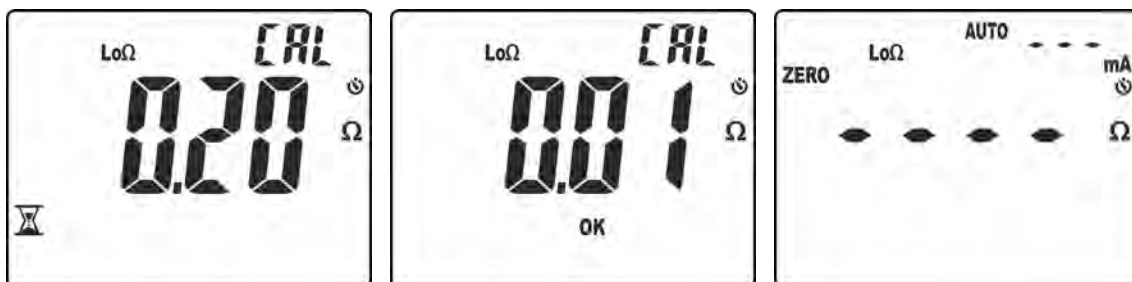

Fig. 33: Results of a correctly performed zeroing

4. The instrument performs the first measurement, detecting the resistance of the test cables (see Fig. 33 – left side). If the compensated value (ZERO) is $\leq 5.00\Omega$, the instrument keeps it saved and carries out the following test by performing a second measurement and comparing this new value to the compensated one. If the difference between the values is $\leq 0.01\Omega$, calibration is confirmed and the message “OK” is displayed (see Fig. 33 – middle). Subsequently, the instrument goes back to the measuring screen with the message “ZERO” displayed to indicate that cable compensation is present.
5. In case the first measurement detects a resistance of test cables $>5.00\Omega$, the instrument shows the following screens in a quick sequence:

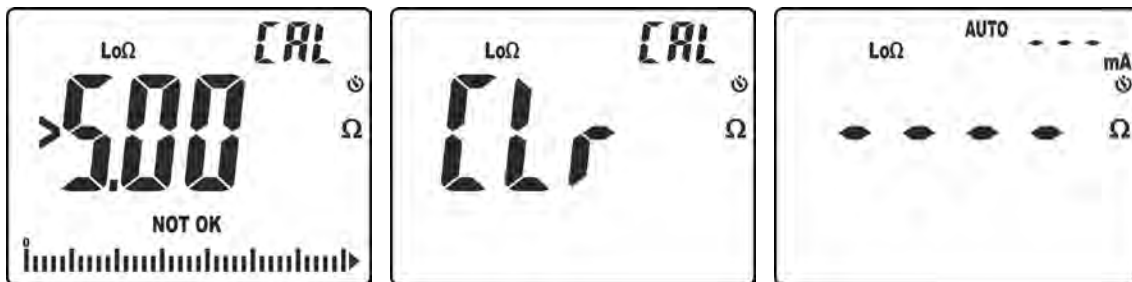

Fig. 34: Results of zeroing not correctly performed

6. Messages “ $>5.00\Omega$ ” and “NOT OK” are initially shown on the display (see Fig. 34 – left side). Subsequently, message “CLR” is shown, to indicate that calibration has been cancelled (see Fig. 34 – middle) and the message “ZERO” is not shown in the measuring screen (see Fig. 34 – right side).
7. To zero a cable calibration in the instrument, carry out the procedure with **open input terminals** $V_{\Omega}/+$ and **COM**/– and press and hold ($>2s$) key $\blacktriangle/ZERO$. The following screens are displayed in a quick sequence:



Fig. 35: Zeroing calibration

5.8. MEASUREMENT DC, AC, AC+DC, INRUSH CURRENT WITH CLAMP TRANSDUCERS

CAUTION



- Maximum measurable current in this function is 3000A AC or 1000A DC. Do not measure currents exceeding the limits given in this manual.
- The instrument carries out the measurement both with flexible clamp transducers (optional accessories) and with other **standard** clamp transducers in the HT family (optional accessories). With transducers having an Hypertac output connector, the optional adapter NOCANBA is necessary to obtain the connection.

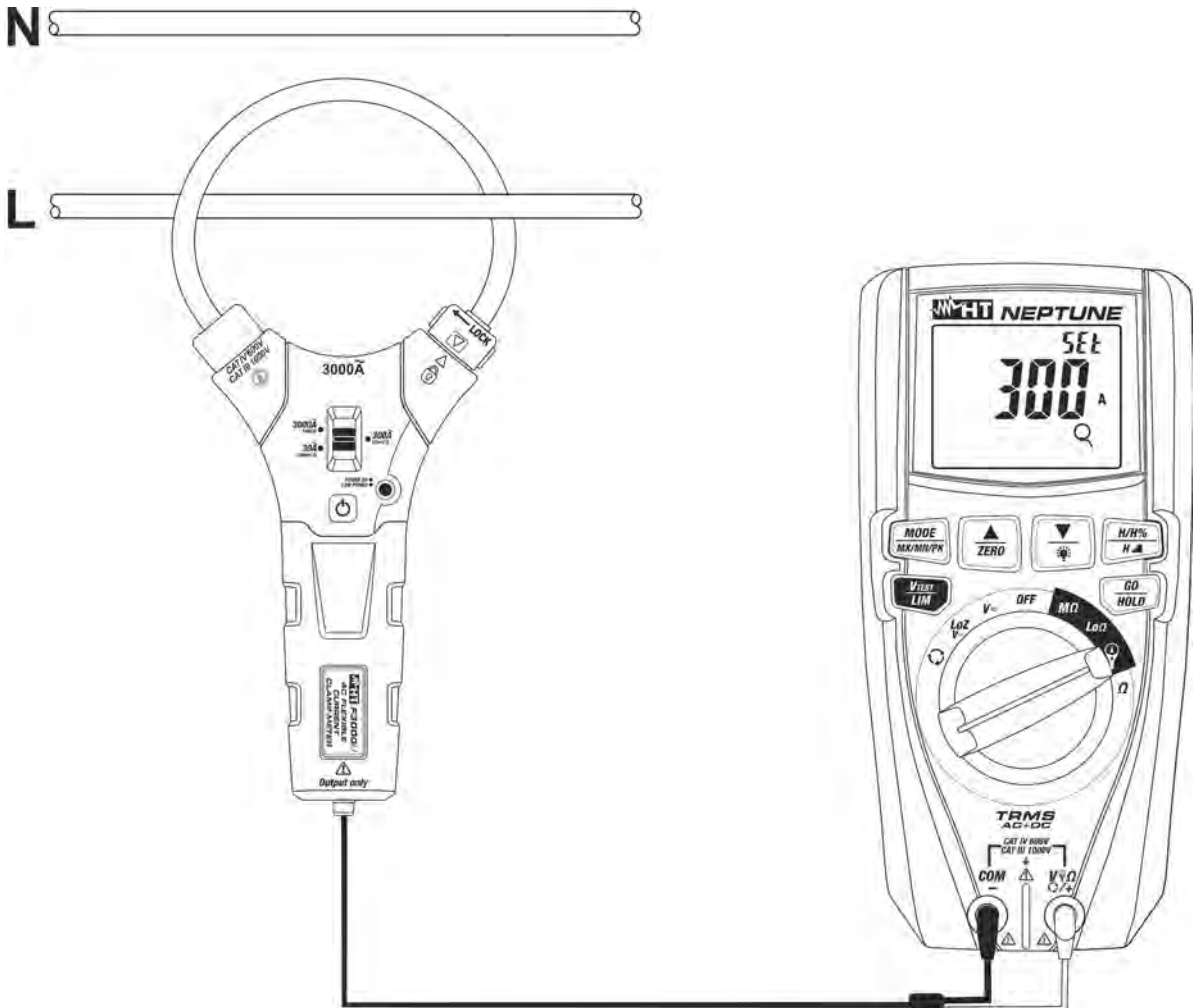

Fig. 36: Use of the instrument for current measurement with clamp transducer

1. Select the position.
2. Press key **MODE/MXMNPK** to select the type of clamp transducer among the options: "Q" (flexible clamp transducer – only AC) or "A" (standard clamp transducer – AC or DC).
3. Press keys / or and, on the instrument, select the **same range** set on the clamp, among the options: **30A, 300A, 3000A** (AC current measurement with flexible clamp) or: **1A, 10A, 30A, 40A, 100A, 200A, 300A, 400A, 1000A, 2000A, 3000A** for AC, DC, AC+DC current measurement with standard clamp).
4. For flexible clamp transducers, set the relevant full scale value of voltage (see § 4.2.10).
5. Press key **GO/HOLD** to confirm settings.

6. For standard clamp transducers, press key **MODE/MXMNPK** to select “AC”, “DC” or “AC+DC” measurement. Anyway, the instrument automatically recognizes AC or DC quantities.
7. Insert the red cable into input terminal **V Ω /+** and the black cable into input terminal **COM/-**. For standard transducers with Hypertac connector, use optional adapter NOCANBA. For information on the use of clap transducers, please refer to the relevant user manual.
8. Insert the cable into the center of the jaws (see Fig. 36). The value of current is shown in Fig. 37

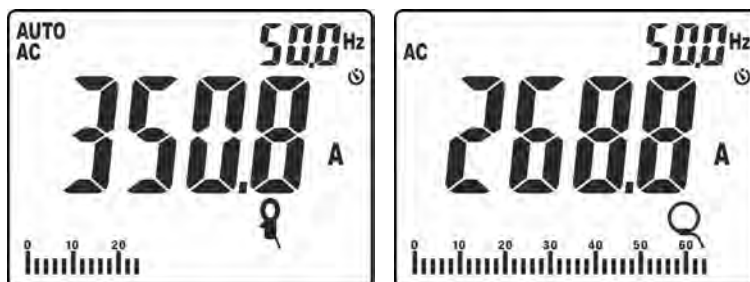

Fig. 37: Result of AC current measurement with standard and flexible clamp

9. Press key **MODE/MXMNPK** to display the value of frequency of AC current with a high resolution (see Fig. 38).

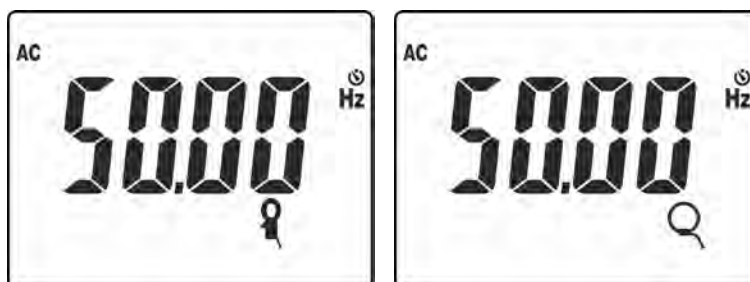

Fig. 38: Result of frequency measurement with standard and flexible clamp

10. The following screens may be shown on the display:



Fig. 39: Anomalous situations on current measurement with clamp transducers

11. Message “>300A” indicates that the value of current measured is higher than the set full scale (300A in case of Fig. 39). If the display shows the messages “<32.00Hz” or “>1000Hz”, the measured value of current frequency is out of the measuring range **32Hz ÷ 1000Hz**.
12. To use functions HOLD, MAX/MIN/PK, H/H%/H, see § 4.2

Inrush current measurement (DIRC)

CAUTION



- Maximum measurable current in this function is 3000A AC or 1000A DC. Do not measure currents exceeding the limits given in this manual.
- The instrument carries out the measurement both with flexible clamp transducers (optional accessories) and with other **standard** clamp transducers in the HT family (optional accessories). For inrush currents containing a high DC component, the use of AC/DC clamps is **recommended**. With transducers having an Hypertac output connector, the optional adapter NOCANBA is necessary to obtain the connection.

1. Select the position.
2. Press key **MODE/MXMNPK** to select the type of clamp transducer among the options: "Q" (flexible clamp transducer – only AC) or "♀" (standard clamp transducer – AC or DC).
3. Press the keys ∇ / or \blacktriangle and, on the instrument, select the **same range** set on the clamp, among the options: **30A, 300A, 3000A** (AC current measurement with flexible clamp) or: **1A, 10A, 30A, 40A, 100A, 200A, 300A, 400A, 1000A, 2000A, 3000A** for AC or AC+DC current measurement with standard clamp.
4. For flexible clamp transducers, set the relevant full scale value (see § 4.2.10).
5. Press key **GO/HOLD** to confirm settings.
6. Press key **MODE/MXMNPK** to select "IRC" measurement. The following screens are shown on the display according to the type of clamp used:

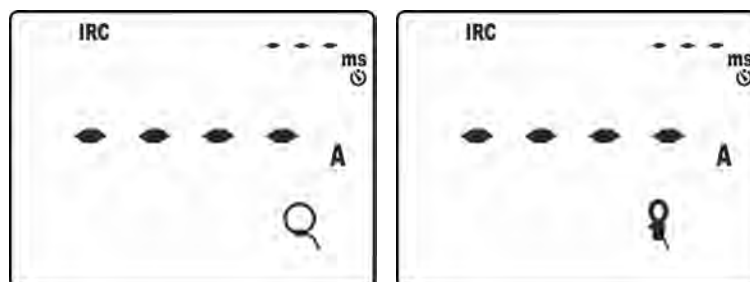

Fig. 40: Initial screens of inrush current measurement

7. Connect the clamps to the system to be tested as indicated in § 5.8
8. Press key **GO/STOP** to activate the function. The instrument waits for the event to be recognized (measured value higher than the fixed trigger threshold equal to **1%FS clamp: e.g. 30A with FS = 3000A**) and shows symbol "⌚" on the display (see Fig. 41 – left side).

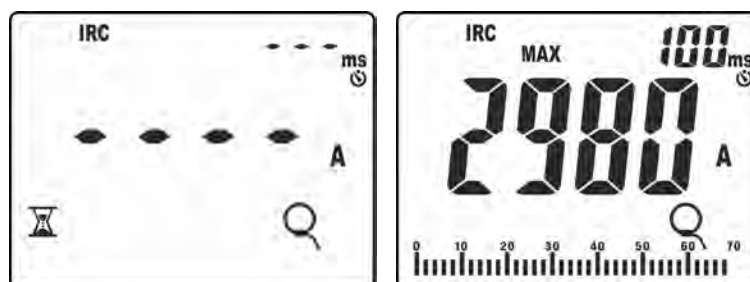

Fig. 41: Recognition of inrush current event

9. Upon recognition of the event, **measurement stops automatically** and the instrument shows, in its main display, the **Max RMS** value calculated according to the evaluation time of **100ms** (default) indicated on the secondary display (see Fig. 41 – right side).
10. Press keys ▼/⏏ or ▲ to select the display of the following parameters:
- Peak value “Pk” calculated in **1ms** (see Fig. 42 – left side)
 - Max RMS value calculated in **16.7ms**
 - Max RMS value calculated in **20ms**
 - Max RMS value calculated in **50ms**
 - Max RMS value calculated in **100ms**
 - Max RMS value calculated in **150ms**
 - Max RMS value calculated in **175ms**
 - Max RMS value calculated in **200ms**

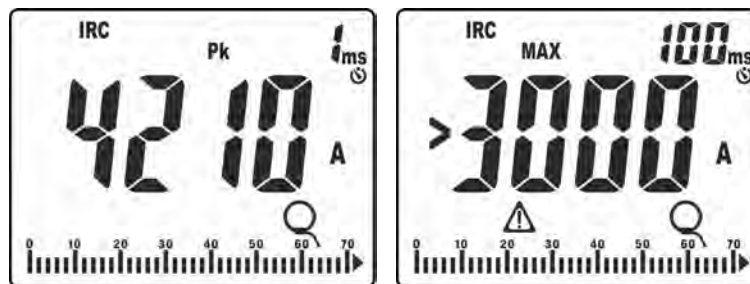

Fig. 42: Examples of display of inrush current

11. If the measured current is higher than the set FS of the clamp, a message like the one in Fig. 42 – right side (relevant to FS = 3000A) is shown on the display.
12. Press key **GO/HOLD** again to start a new measurement or turn the rotary switch to quit the function.

6. MAINTENANCE



CAUTION

- Only expert and trained technicians should perform maintenance operations. Before carrying out maintenance operations, disconnect all cables from the input terminals.
- Do not use the instrument in environments with high humidity levels or high temperatures. Do not expose to direct sunlight.
- Always switch off the instrument after use. In case the instrument is not to be used for a long time, remove the battery to avoid liquid leaks that could damage the instrument's internal circuits.

6.1. BATTERY REPLACEMENT





When the LCD display shows symbol  and the indication "bAtt" (see Fig. 43), batteries need to be replaced, operating as follows:



Fig. 43: Screen with low battery indication

1. Position the rotary switch to **OFF** and remove the cables from the input terminals.
2. Turn the fastening screw of the battery compartment cover from position  to position  and remove it.
3. Remove the battery and insert a new battery of the same type (see § 7.1.1), respecting the indicated polarity.
4. Restore the battery compartment cover into place and turn the fastening screw from position  to position .
5. Do not scatter old batteries into the environment. Use the relevant containers for disposal.

6.2. CLEANING THE INSTRUMENT

Use a soft and dry cloth to clean the instrument. Never use wet cloths, solvents, water, etc.

6.3. END OF LIFE



WARNING: the symbol on the instrument indicates that the appliance and its accessories must be collected separately and correctly disposed of.

7. TECHNICAL SPECIFICATIONS

7.1. TECHNICAL CHARACTERISTICS

Accuracy calculated as [%reading + (no. digits*resolution)] at 23°C ± 5°C <80%RH.

DC Voltage (Autorange)

Range [V]	Resolution [V]	Accuracy	Input impedance	Overload protection
0.0 ÷ 999.9	0.1	±(0.5%rdg + 2digits)	5MΩ	1000VDC/ACrms

AC, AC+DC, LoZ TRMS Voltage (Autorange)

Range [V]	Resolution [V]	Frequency	Accuracy	Overload protection
0.5 ÷ 999.9	0.1	32Hz ÷ 1kHz	±(0.5%reading + 2digits)	1000VDC/ACrms

Input impedance function VAC: 5MΩ,

Input impedance function LoZ: 3.5kΩ for 10s (@ 110V/50Hz), 4.5s (@ 230V/50Hz), 1s (@ 400V/50Hz). For higher voltage values, input impedance becomes higher than 10kΩ. **WARNING: do not leave the instrument connected for more than 1min.**

Automatic selection DC mode, Max crest factor: 1.5

Current and Voltage frequency (Autorange)

Range [Hz]	Resolution [Hz]	Accuracy
32.00 ÷ 99.99	0.01	±(0.1%rdg + 1digit)
100.0 ÷ 999.9	0.1	

Voltage range: 0.5V ÷ 999.9V, Current field: 0.5A ÷ 3000A (Flexible clamp F3000U), 1mV ÷ 1000mV (STD clamp)

AC TRMS Current (Flexible clamp F3000U) – (Autorange)

Range [mV]	Resolution [mV]	Accuracy (*)
1 ÷ 3000	1	±(0.5%rdg + 2digits)

(*) For frequency >100Hz accuracy is: ±(1.5%reading + 5digits)

Max crest factor: 3 ; Frequency bandwidth: 1kHz ; Current zeroed for value <1%FS [A]

AC TRMS Current (flexible clamp FS 1V) and DC, AC, AC+DC (STD clamp) – (Autorange)

Range [mV]	Resolution [mV]	Accuracy (*)
1 ÷ 1000	1	±(0.5%rdg + 2digits)

(*) For frequency >100Hz accuracy is: ±(1.5%reading + 5digits)

Max crest factor: Frequency bandwidth: 1kHz;

Current zeroed for value <1%FS [A] (Flex clamp 1V), Current zeroed for value <1%FS [A] (STD clamp)

AC TRMS inrush current (Flexible clamp F3000U)

Range [mV]	Resolution [mV]	Accuracy (*)
1 ÷ 3000	1	±(2%reading + 2digits)

(*) Accuracy declared for frequency: DC, 42.5 ÷ 69Hz

Max crest factor: 3, Sampling frequency: 4kHz

Detection threshold: 1%FS [A] fixed

Response time: 1ms (Peak), 16.7ms, 20ms, 50ms, 100ms, 150ms, 175ms, 200ms (max RMS)

AC TRMS inrush current (Flexible clamp 1V) and DC, AC, AC+DC TRMS (STD clamp)

Range [mV]	Resolution [mV]	Accuracy (*)
1 ÷ 1000	1	±(2%reading + 2digits)

(*) Accuracy declared for frequency: DC, 42.5 ÷ 69Hz

Max crest factor: 3, Sampling frequency: 4kHz

Detection threshold: 1%FS [A] fixed

Response time: 1ms (Peak), 16.7ms, 20ms, 50ms, 100ms, 150ms, 175ms, 200ms (max RMS)

Resistance and continuity test (Autorange)

Range [Ω]	Resolution [Ω]	Accuracy	Buzzer
0.0 ÷ 199.9	0.1	±(1.0%reading + 5digits)	<30Ω
200 ÷ 1999	1		

Harmonic voltage and current (Autorange)

Harmonic order	Fundamental frequency	Resolution	Accuracy (*) (non-zeroed values)
DC	42.5Hz ÷ 69Hz	0.1V / 0.1A / 0.1%	±(5.0%rdg+20digits)
1 ÷ 25			±(5.0%rdg+10digits)
THD%		0.1%	±(10.0%rdg+10digits)

Accuracy of harmonic amplitudes expressed in % is evaluated considering the accuracy of parameters' ratio

(*) Harmonic voltages will be zeroed under the following conditions:

- 1st harmonic: value <0.5V
- DC, 2nd to 25th harmonic: harmonic value <0.5% fundamental value or value <0.5V

(*) Harmonic currents will be zeroed under the following conditions

- 1st harmonic: value <1%FS[A]
- DC, 2nd to 25th harmonic: harmonic value <0.5% fundamental value or value <1%FS[A].

Insulation resistance (MΩ)

Test voltage [V]	Range [Ω]	Resolution [Ω]	Accuracy
50	0.1k ÷ 499.9k	0.1k	±(5.0%rdg + 5dgt)
	0.50M ÷ 9.99M	0.01M	
	10.0M ÷ 99.9M	0.1M	
100	0.1k ÷ 499.9k	0.1k	
	0.50M ÷ 9.99M	0.01M	
	10.0M ÷ 199.9M	0.1M	
250	0.01M ÷ 9.99M	0.01M	±(2.0%rdg + 2dgt)
	10.0M ÷ 99.9M	0.1M	±(5.0%rdg + 2dgt)
	100M ÷ 499M	1M	
500	0.01M ÷ 9.99M	0.01M	±(2.0%rdg + 2dgt)
	10.0M ÷ 199.9M	0.1M	
	200M ÷ 499M	1M	±(5.0%rdg + 2dgt)
	500M ÷ 999M		
1000	0.01M ÷ 9.99M	0.01M	±(2.0%rdg + 2dgt)
	10.0M ÷ 199.9M	0.1M	
	200M ÷ 999M	1M	±(5.0%rdg + 2dgt)
	1000M ÷ 1999M		

Open-circuit voltage: rated test voltage (-0% ÷ 10%)

Short-circuit current: < 6mA (peak) with each rated test voltage

Rated test current: >1mA with 1kΩ x Vnom (50V, 100V, 250V, 1000V), >2.2mA with 230kΩ @ 500V

Input protection: error message for voltage > 10V

Continuity of protective conductors (LoΩ)

Range [Ω]	Resolution [Ω]	Accuracy
0.00 ÷ 9.99	0.01	±(2.0%reading + 2digits)
10.0 ÷ 199.9	0.1	

Test current: >200mA DC up to 5Ω (cables included), resolution 1mA, accuracy ±(5.0%reading + 5digits).

Open-circuit voltage: $4 < V_0 < 12V$

Input protection: error message for voltage > 10V

Phase sequence with 1 terminal (*)

Voltage range L-N, L-PE [V]	Frequency range
100.0 ÷ 999.9	42.5 ÷ 69Hz

(*) Measurement possible by direct contact on the metallic parts of the conductors (not on the insulating sheath)

Reference guidelines



Instrument safety:	IEC/EN61010-1, IEC/EN61010-2-030, IEC/EN61010-2-033
EMC:	IEC/EN 61326-1
MΩ test:	IEC/EN 61557-2
LoΩ test:	IEC/EN 61557-4
Insulation:	double insulation
Pollution level:	2
Measurement category:	CAT IV 600V, CAT III 1000V to earth and between inputs

7.1.1. General characteristics

Mechanical characteristics

Size (L x W x H):	175 x 85 x 55mm (7 x 3 x 2in)
Weight (batteries included):	420g (15ounces)
Mechanical protection:	IP40

Power supply

Battery type:	4x1.5V batteries type AAA IEC LR03
Low battery indication:	symbol  on the display
Battery life:	V, A, Ω,  → approx. 132h (backlight OFF) V, A, Ω,  → approx. 68h (backlight ON) MΩ (@500V) → approx. 400 tests (backlight OFF). LoΩ → approx. 2000 tests (backlight OFF).
Auto Power Off:	after 15 minutes' idling (can be disabled)

Display

Type of display:	4 dgt LCD, max 9999 dots, decimal sign, point backlight and bargraph, indication of polarity
Sampling frequency:	2 times/s
Conversion:	RMS

7.2. ENVIRONMENTAL CONDITIONS FOR USE

Reference temperature:	23°C ± 5°C (73°F ± 41°F)
Operating temperature:	5°C ÷ 40°C (41°F ÷ 104°F)
Allowable relative humidity:	<80%RH
Storage temperature:	-20°C ÷ 60°C (-4°F ÷ 140°F)
Storage humidity:	<80%RH
Max operating altitude:	2000m (6562ft)

This instrument satisfies the requirements of Low Voltage Directive 2014/35/EU (LVD) and of EMC Directive 2014/30/EU.

This instrument satisfies the requirements of European Directive 2011/65/EU (RoHS) and 2012/19/EU (WEEE).

7.3. ACCESSORIES

7.3.1. Standard accessories

- Pair of test tips Red/Black 2/4mm straight banana Cod. 4324-2
- Pair of alligator clip Red/Black Cod. YAAMK0001HT0
- Alkaline battery 1.5V, type AAA, IEC LR03, 4 pcs Cod. YABAT0001HT0
- Carrying bag Cod. YABRS0002HT0
- ISO calibration certificate
- Quick reference guide Cod. YAMUM0067HT0
- User manual on CD-ROM Cod. YAMUM0068HT0

7.3.2. Optional accessories

- Flexible clamp transducer AC 30/300/3000A Code F3000U
- Standard clamp transducer DC/AC 40-400A/1V Code HT4006
- Standard clamp transducer AC 1-100-1000A/1V, Hypertac conn. Code HT96U
- Standard clamp transducer AC 10-100-1000A/1V, Hypertac conn. Code HT97U
- Standard clamp transducer DC 1000A/1V, Hypertac conn. Code HT98U
- Adapter for connection standard clamp with Hypertac connector Code NOCANBA

8. ASSISTANCE

8.1. WARRANTY CONDITIONS

This instrument is warranted against any material or manufacturing defect, in compliance with the general sales conditions. During the warranty period, defective parts may be replaced. However, the manufacturer reserves the right to repair or replace the product. Should the instrument be returned to the After-sales Service or to a Dealer, transport will be at the Customer's charge. However, shipment will be agreed in advance. A report will always be enclosed to a shipment, stating the reasons for the product's return. Only use original packaging for shipment. Any damage due to the use of non-original packaging material will be charged to the Customer. The manufacturer declines any responsibility for injury to people or damage to property.

The warranty shall not apply in the following cases:

- Repair and/or replacement of accessories and battery (not covered by warranty).
- Repairs that may become necessary as a consequence of an incorrect use of the instrument or due to its use together with non-compatible appliances.
- Repairs that may become necessary as a consequence of improper packaging.
- Repairs which may become necessary as a consequence of interventions performed by unauthorized personnel.
- Modifications to the instrument performed without the manufacturer's explicit authorization.
- Use not provided for in the instrument's specifications or in the instruction manual.

The content of this manual cannot be reproduced in any form without the manufacturer's authorization.

Our products are patented and our trademarks are registered. The manufacturer reserves the right to make changes in the specifications and prices if this is due to improvements in technology.

8.2. ASSISTANCE

If the instrument does not operate properly, before contacting the After-sales Service, please check the conditions of battery and cables and replace them, if necessary. Should the instrument still operate improperly, check that the product is operated according to the instructions given in this manual. Should the instrument be returned to the After-sales Service or to a Dealer, transport will be at the Customer's charge. However, shipment will be agreed in advance. A report will always be enclosed to a shipment, stating the reasons for the product's return. Only use original packaging for shipment; any damage due to the use of non-original packaging material will be charged to the Customer.

9. THEORETICAL APPENDIXES

9.1. CONTINUITY OF PROTECTIVE CONDUCTORS

Purpose of the test

Checking the continuity of:

- Protective conductors (PE), main equalizing potential conductors (EQP), secondary equalizing potential conductors (EQS) in TT and TN-S systems.
- Neutral conductors having functions of protective conductors (PEN) in TN-C systems.

This test is to be preceded by a visual check verifying the existence of yellow-green protective and equalizing potential conductors as well as compliance of the sections used with the standards' requirements.

Parts of the system to be checked

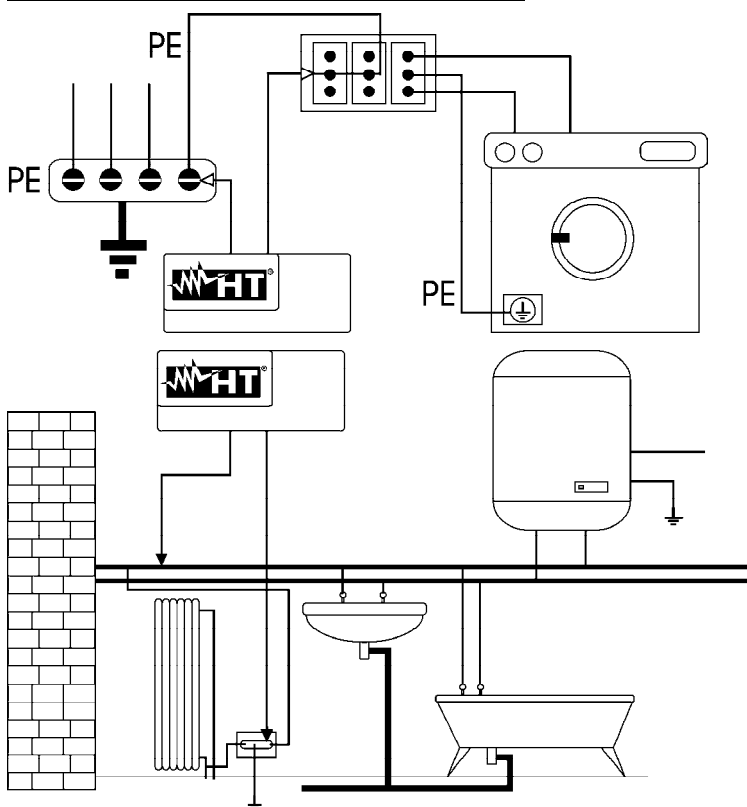

Connect one of the test leads to the protective conductor of the socket and the other to the equalizing potential node of the earth installation.

Connect one of the test leads to the external mass (in this case the water pipe) and the other to the earth installation using for example the protective conductor of the closest socket.

Fig. 44: Examples of continuity measures of conductors

Check continuity between:

- Earth poles of all the plug sockets and earth collector or node.
- Earth terminals of class I appliances (boilers, etc.) and earth collector or node.
- Main external masses (water tubes, gas tubes, etc.) and earth terminal or node.
- Additional external masses between each other and to earth terminal.

Allowable values

The standards do not require the measurement of continuity resistance and the comparison of the results with limit values. The standards simply require that the instrument in use warns the operator if the test was not carried out with a current of at least 200mA and an open-circuit voltage ranging from 4 to 24V. The resistance values may be calculated according to the sections and lengths of the conductors being tested. In general, if the instrument detects values of some ohms, the test may be considered as successful.

9.2. MEASUREMENT OF INSULATION RESISTANCE

Purpose of the test

Check that the insulation resistance of the installation complies with the requirements of the applicable standard. This test has to be performed with the circuit being tested not powered and with the possible loads it supplies disconnected.

Description	Test voltage [V]	Minimum allowable value [MΩ]
SELV or PELV systems	250VDC	> 0.250 MΩ
Systems up to 500V (private inst.)	500VDC	> 1.00 MΩ
Systems over 500V	1000VDC	> 1.00 MΩ

Table 1: Most common test types, test voltages and relevant limit values.

Parts of the system to be checked

Check the insulation resistance between:

- Each active conductor and the earth (the neutral conductor is considered as an active conductor except in TN-C power supply systems, where it is considered as part of the earthing (PEN)). During this measurement, all active conductors may be connected to each other. Should the measured result not be within the limits prescribed by the standards, the test must be repeated separately for each single conductor.
- Active conductors. Guidelines recommends also checking the insulation between active conductors when it is possible.

Allowable values

The values of the measured voltage and of the minimum insulation resistance can be taken from the following table:

Rated voltage of circuit [V]	Test voltage [V]	Insulation resistance [MΩ]
SELV and PELV *	250	≥ 0.250
Up to/equal to 500 V, except for the above-mentioned circuits	500	≥ 0.500
Over 500 V	1000	≥ 1,000

* The terms SELV and PELV replace, in the standard's new wording, the old definitions of "very low safety voltage" or "very low functional voltage".

Table 2: Most common test types, insulation resistance measurement

If the system includes electronic devices, it is necessary to disconnect them from the system. Should this not be possible, only perform the test between active conductors (which, in this case, must be connected to each other) and the earth connection.

EXAMPLE OF HOW TO MEASURE THE INSULATION OF A SYSTEM

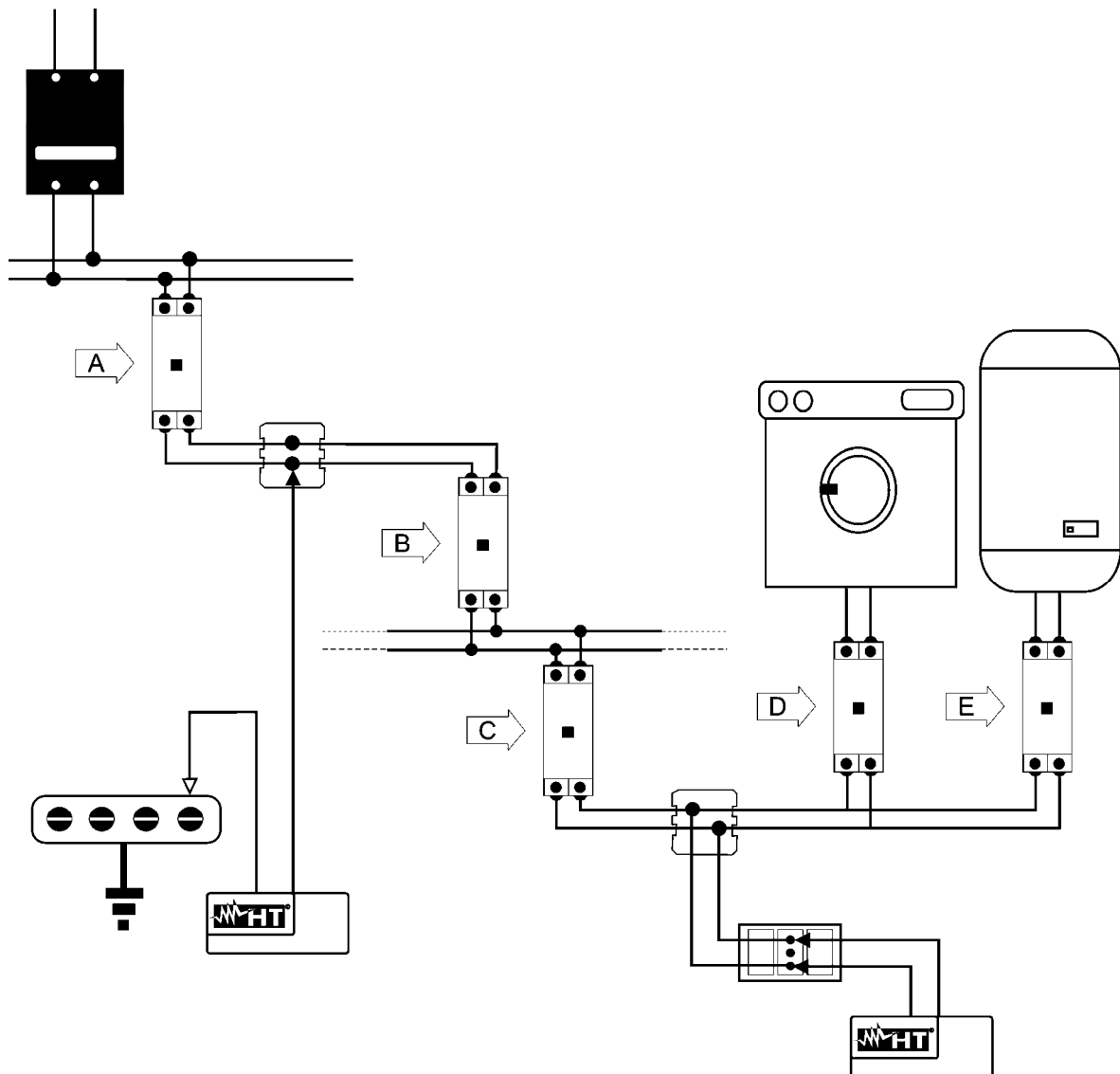

Fig. 45: Example of an electric system

Switches D and E are the switches installed near the load which have the function of separating the load from the system. Should these switches not be provided, or should they be single-pole switches, it is necessary to disconnect the users from the system before performing the insulation resistance test.

An indicative procedure of how to measure the insulation resistance of a system is given in the table below:

Switch conditions		Spot where to perform measurement	Measurement	System evaluation
1.	Open switches A, D and E	On switch A	If $R \geq R_{LIMITE}$	☺ OK (end of test)
			If $R < R_{LIMITE}$	Proceed to ¶ 2
2.	Open switch B	On switch A	If $R \geq R_{LIMITE}$	Proceed to ¶ 3
			If $R < R_{LIMITE}$	⊗ Insulation between switches A and B is too low. Restore insulation and measure again.
3.		On switch B	If $R \geq R_{LIMITE}$	☺ OK (end of test)
			If $R < R_{LIMITE}$	⊗ Insulation is too low downstream of switch B. Proceed to ¶ 4
4.	Open switch C	On switch B	If $R \geq R_{LIMITE}$	Proceed to ¶ 5
			If $R < R_{LIMITE}$	⊗ Insulation between switches B and C is too low. Restore insulation and measure again.
5.		On switch C	If $R \geq R_{LIMITE}$	☺ OK (end of test)
			If $R < R_{LIMITE}$	⊗ Downstream of switch B, insulation is too low. Restore insulation and measure again.

Table 3: Procedure for measuring insulation in the system reported in Fig. 45

In the presence of a very extended circuit, wires running side by side constitute a capacity that the instrument must load in order to obtain a correct measurement; in this case it is advisable to hold the start button of the measurement (in case you run the test in manual mode) until the result is stable.

When performing measurements between active conductors, it is absolutely necessary to disconnect all users (alarm lights, intercom transformers, etc.), otherwise the instrument will measure their resistance instead of the system's insulation. Moreover, an insulation resistance test between active conductors may damage them.

The “> full scale” message indicates that the insulation resistance measured by the instrument is higher than the maximum measurable resistance value. This result is obviously much higher than the minimum limits in the standard table above, so the insulation in that spot is to be considered as compliant with the standards.

9.2.1. Polarization Index (PI)

The purpose of this diagnostic test is to evaluate the influence of the polarization effects. Upon the application of a high voltage to insulation, the electric dipoles distributed in the insulation align in the direction of the applied electric field. This phenomenon is called polarization. Because of the polarized molecules, a polarization (absorption) current generates, which lowers the total value of insulation resistance.

Parameter **PI** consists in the ratio between the value of insulation resistance measured after 1 minute and after 10 minutes. The test voltage is maintained throughout the whole duration of the test and, at the end, the instrument provides the value of ratio:

$$PI = \frac{R_{iso} (10 \text{ min})}{R_{iso} (1 \text{ min})}$$

Some reference values:

PI Value	Insulation condition
from 1.0 to 1.25	Not acceptable
from 1.4 to 1.6	Good
>1.6	Excellent

9.2.2. Dielectric Absorption Ratio (DAR)

Parameter **DAR** consists in the ratio between the value of insulation resistance measured after 30s and after 1 minute. The test voltage is maintained throughout the whole duration of the test and, at the end, the instrument provides the value of ratio:

$$DAR = \frac{R_{iso} (1 \text{ min})}{R_{iso} (30 \text{ s})}$$

Some reference values:

DAR Value	Insulation condition
< 1.0	Dangerous
from 1.0 to 2.0	Questionable
from 2.0 to 4.0	Good
> 4.0	Excellent

9.3. VOLTAGE AND CURRENT HARMONICS

Any periodic non-sinusoidal wave may be represented by a sum of sinusoidal waves, each with a frequency which is a whole multiple of the fundamental, according to the relationship:

$$v(t) = V_0 + \sum_{k=1}^{\infty} V_k \sin(\omega_k t + \varphi_k) \quad (1)$$

where: V_0 = Average value of $v(t)$
 V_1 = Amplitude of the fundamental of $v(t)$
 V_k = Amplitude of the k -nth harmonic of $v(t)$

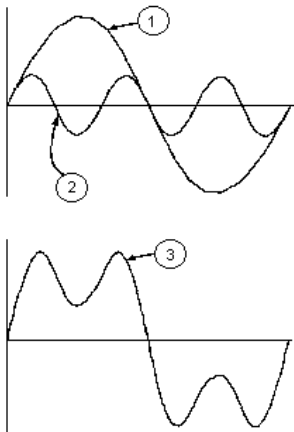

CAPTION:

1. Fundamental
2. Third Harmonic
3. Distorted waveform sum of two components

Fig. 46: Effect of overlapping of two frequencies, one multiple of the other

For network voltage, the fundamental has a frequency of 50Hz, the second harmonic has a frequency of 100 Hz, the third harmonic has a frequency of 150Hz and so on. Harmonic distortion is a continuous problem and must not be confused with short-duration phenomena such as peaks, drops or fluctuations. It can be seen from (1) that each signal consists of the summation of infinite harmonics. However, an order number exists beyond which the value of the harmonics may be considered as negligible. Standard EN50160 suggests cutting the summation in the expression (1) at the 40th harmonic. A fundamental index to detect the presence of harmonics is the THD% (Total Harmonic Distortion) defined as:

$$THD\% = \frac{\sqrt{\sum_{h=2}^{40} V_h^2}}{V_1} \times 100$$

This index takes into consideration the presence of all harmonics, and the more distorted is the waveform, the higher is the index.

Limit values for harmonics

Standard EN50160 prescribes the limits for the Harmonic voltages the Supplier may put in network. In normal operating conditions, at any time in a week, 95% of the efficient values of each harmonic voltage, averaged to 10 minutes, must be lower than or equal to the values indicated in Table 4. The overall harmonic distortion (THD%) of supply voltage (including all harmonics up to the 40th) must be lower than or equal to 8%.

Odd Harmonics				Even Harmonics	
Not multiple of 3		Multiple of 3		Order h	Relative Voltage %Max
Order h	Relative Voltage %Max	Order h	Relative Voltage %Max		
5	6	3	5	2	2
7	5	9	1.5	4	1
11	3.5	15	0.5	6..24	0.5
13	3	21	0.5		
17	2				
19	1.5				
23	1.5				
25	1.5				

Table 4: Limits for the harmonic voltages the supplier may introduce into the network.

These limits, which theoretically apply only to Electric Power Suppliers, anyway provide a series of reference values within which also the harmonics put into network by users should be kept.