



ENGLISH

User manual



CONTENTS

1. PRECAUTIONS AND SAFETY MEASURES	2
1.1. Preliminary instructions	2
1.2. During use	2
1.3. After use	2
2. GENERAL DESCRIPTION	3
3. PREPARATION FOR USE	3
3.1. Initial checks	3
3.2. Instrument power supply	3
3.3. Storage	3
4. NOMENCLATURE	4
4.1. Description of the instrument	4
4.2. Display description	4
4.3. Description of function keys	5
4.3.1. Key ON/OFF	5
4.3.2. Key 	5
4.3.3. Keys ◀ and ▶	5
4.3.4. Key RH%	5
4.3.5. Key MOI	5
4.3.6. Key MODE/ZERO	5
4.3.7. Key IRT/ 	6
4.3.8. Key MEM/ALM	6
4.3.9. Operations with the memory	6
4.3.10. Setting of alarm thresholds on measurements	7
4.3.11. Disabling the Auto Power OFF function	9
5. OPERATING INSTRUCTIONS	10
5.1. Measurement of air temperature and humidity	10
5.2. Moisture measurement of materials	11
5.2.1. Measurement with in-built sensor	11
5.2.2. Measurement with external probe	12
5.3. Infrared temperature measurement	13
5.4. Measurement of surface temperature difference	14
6. MAINTENANCE	15
6.1. General information	15
6.2. Replacing the battery	15
6.3. Cleaning the instrument	15
6.4. End of life	15
7. TECHNICAL SPECIFICATIONS	16
7.1. Technical characteristics	16
7.1.1. General characteristics	16
7.2. Environment	17
7.2.1. Environmental conditions for use	17
7.3. Accessories	17
7.3.1. Accessories provided	17
8. ASSISTANCE	18
8.1. Warranty conditions	18
8.2. Assistance	18

1. PRECAUTIONS AND SAFETY MEASURES

The instrument has been designed in compliance with the safety directive relevant to electronic measuring instruments. In order to prevent damaging the instrument, please carefully follow the procedures described in this manual and read all notes preceded by symbol  with the utmost attention. Before and after carrying out measurements, carefully observe the following instructions:

- Do not carry out any measurements in case gas, explosive materials or flammables are present, or in humid or dusty environments.
- Do not carry out any measurement in case you find anomalies in the instrument such as deformation, substance leaks, absence of display on the screen, etc.

In this manual, and on the instrument, the following symbols are used:



Warning: observe the instructions given in this manual; improper use could damage the instrument or its components.



This symbol on the display means that the instrument is able to emit a laser pointer in Class 2. **Do not direct the radiation towards the eyes in order to prevent injury.**

1.1. PRELIMINARY INSTRUCTIONS

- We recommend following the normal safety rules devised to protect the user against dangerous situations and the instrument against incorrect use.
- Only the accessories provided together with the instrument will guarantee safety standards. They must be used only if in good conditions and replaced with identical models, when necessary.
- Do not test circuits exceeding the specified limits.
- Check that the battery is correctly inserted.

1.2. DURING USE

Please carefully read the following recommendations and instructions:



CAUTION

Failure to comply with the caution notes and/or instructions may damage the instrument and/or its components or be a source of danger for the operator.

- Use the instrument only in the temperature/humidity ranges indicated in this manual.
- When performing infrared temperature measurements (IRT), pay attention **not to direct the laser pointer towards people's or animals' eyes** in order to prevent injury.

1.3. AFTER USE

- When measurement is complete, switch off the instrument.
- If you expect not to use the instrument for a long period, remove the battery.

2. GENERAL DESCRIPTION

The instrument has the following functions:

- Measurement of relative air humidity (%RH) with in-built sensor
- Air temperature measurement with in-built sensor
- Measurement of dew point temperature (DP = Dew Point)
- Moisture measurement of materials in contact with the in-built sensor
- Moisture measurement of materials in contact with the external probe
- Infrared temperature measurement (IRT) with in-built laser pointer
- Automatic calculation of temperature difference (IRT-DP)
- Measurement of specific humidity in unit of mass (g/kg or GPP)
- MAX MIN function
- Alarm conditions on measurements
- Internal memory for measured data saving
- Backlight
- Bargraph
- Auto Power OFF

Each of these functions can be selected by means of the corresponding key. The selected quantity appears on the display with the indication of the measuring unit and of the enabled functions. Function keys are also available; for their use, please refer to § 4.2.

3. PREPARATION FOR USE

3.1. INITIAL CHECKS

Before shipping, the instrument has been checked from an electric as well as mechanical point of view. All possible precautions have been taken so that the instrument is delivered undamaged. However, we recommend generally checking the instrument in order to detect possible damage suffered during transport. In case anomalies are found, immediately contact the forwarding agent. We also recommend checking that the packaging contains all components indicated in § 7.3.1. In case of discrepancy, please contact the Dealer. In case the instrument should be returned, please follow the instructions given in § 8.

3.2. INSTRUMENT POWER SUPPLY

The instrument is supplied through 1x9V alkaline battery type IEC 6F22, included in the package. Symbol  appears when the battery is flat. Replace the battery by following the instructions given in § 6.2.

3.3. STORAGE

In order to guarantee precise measurement, after a long storage time under extreme environmental conditions, wait for the instrument to come back to normal operating conditions (see § 7.2.1).

4. NOMENCLATURE

4.1. DESCRIPTION OF THE INSTRUMENT

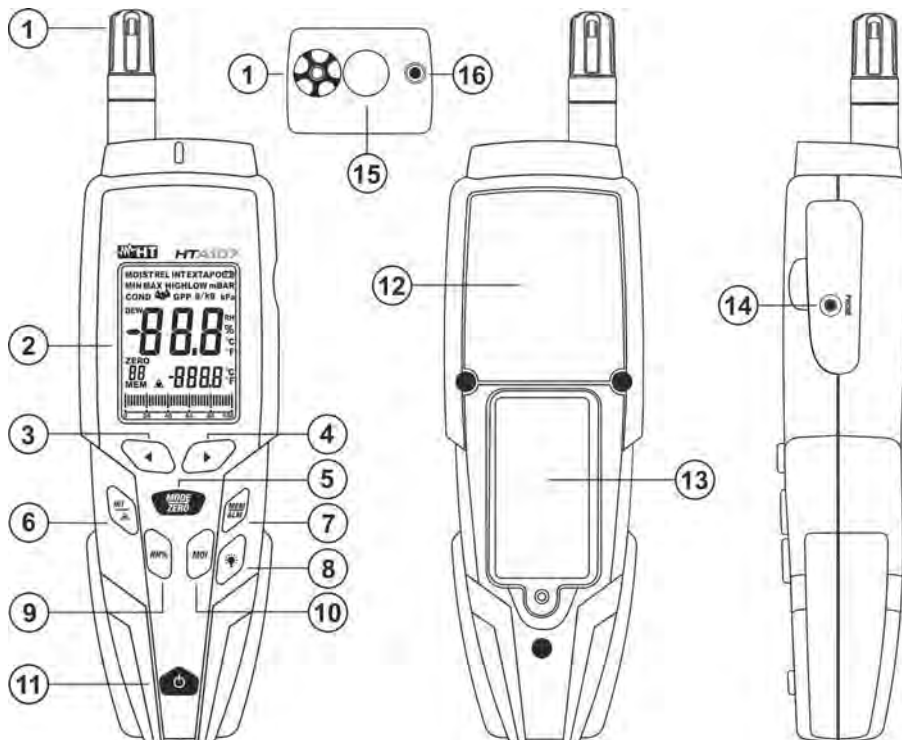

CAPTION:

1. In-built sensor for air temperature/humidity
2. LCD display
3. Key \blacktriangleleft
4. Key \blacktriangleright
5. Key **MODE/ZERO**
6. Key **IRT/ \triangle**
7. Key **MEM/ALM**
8. Key sun
9. Key **RH%**
10. Key **MOI**
11. Key **ON/OFF**
12. In-built sensor for measuring moisture of materials (INT)
13. Battery compartment cover
14. External probe connector (EXT)
15. IRT sensor
16. Laser pointer

Fig. 1: Description of the instrument

4.2. DISPLAY DESCRIPTION

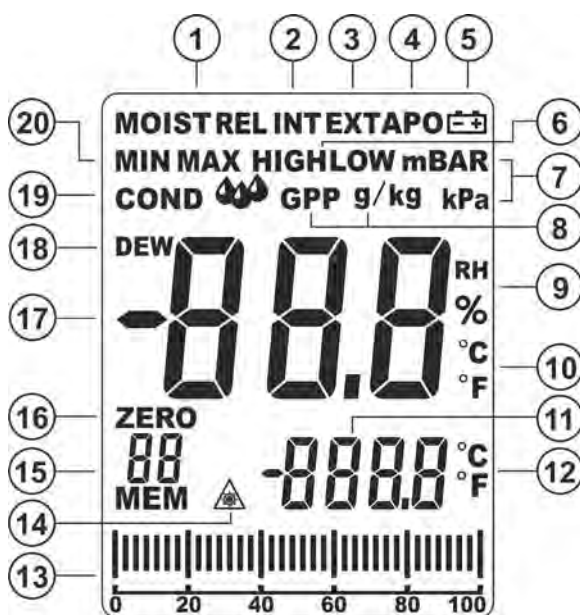

CAPTION:

1. Active MOIST function
2. Active internal MOIST function
3. Active external MOIST function
4. Symbol of active Auto Power OFF (APO)
5. Low battery indication
6. Alarm threshold indication
7. Measuring unit of steam pressure
8. Measuring unit g/kg and GPP
9. Measuring unit of relative humidity
10. Measuring unit of air temperature
11. Secondary display
12. Measuring unit of IRT temperature
13. Bargraph
14. Active laser indication
15. Memory location indication
16. Active ZERO function
17. Main display indication
18. Active DEW function
19. Active COND function
20. Active MAX MIN function

Fig. 2: Display description

4.3. DESCRIPTION OF FUNCTION KEYS

4.3.1. Key ON/OFF

Pressing key **ON/OFF** allows turning on/off the instrument. Key **ON/OFF** also allows deactivating the Auto Power OFF function (see § 4.3.11).

4.3.2. Key ☼

Pressing key ☼ activates/deactivates the display's backlight in any function of the instrument. Upon start-up, backlight is automatically turned on.

4.3.3. Keys ◀ and ▶

Pressing keys ◀ and ▶ allows for the following operations:

- Selection of the measuring unit of air temperature in degrees “°C” or “Celsius” or in degrees “Fahrenheit” or “°F”, for measurements of air relative humidity “%RH” and relative moisture of materials “MOI INT” and “MOI EXT” with reading on the secondary display
- Selection of the measuring unit of specific humidity expressed in **g/kg** or **GPP (Grains Per Pounds)**
- Selection of the measuring unit of steam pressure in measuring mode Condensation between the options “**mBAR**” and “**kPa**” (see § 5.4)
- Setting of the values of Maximum (HIGH) and Minimum (LOW) thresholds in alarm conditions for measurements of relative humidity “%RH”, “MOI INT” and “MOI EXT” (see § 4.3.10)
- Recalling to the display of saved measures and deletion of the internal memory (see § 4.3.9)

4.3.4. Key RH%

Pressing key **RH%** allows for the following operations:

- Activation of measurement of air humidity with in-built sensor (see Fig. 1 – part 1), whose value is shown on the main display
- Activation of the set values of Maximum (HIGH) and Minimum (LOW) thresholds in alarm conditions for measurements of relative humidity “%RH” (see § 4.3.10)
- Activation of measuring mode Condensation (see § 5.4)

4.3.5. Key MOI

Pressing key **MOI** allows for the following operations:

- Activation of moisture measurement of materials with in-built sensor “MOI INT” (see Fig. 1 – part 12) or with external probe “MOI EXT” (see Fig. 1 – part 14), whose value is shown on the main display
- Activation of the set values of Maximum (HIGH) and Minimum (LOW) thresholds in alarm conditions for moisture measurement of materials with in-built sensor “MOI INT” and with external probe “MOI EXT” (see § 4.3.10)
- Activation of measuring mode Condensation and deactivation of measurement of steam pressure (see § 5.4)

4.3.6. Key MODE/ZERO

Pressing key **MODE/ZERO** allows for the following operations:

- selection of dew point measurement (DEW) and of the humidity measurements expressed in unit of mass **g/kg** (for temperature in degrees centigrade) or **GPP (Grains Per Pounds)** (for temperature in degrees Fahrenheit)

- Activation of the set values of Maximum (HIGH) and Minimum (LOW) thresholds in alarm conditions for measurements of air humidity “%RH” and moisture of materials with in-built sensor “MOI INT” and with external probe “MOI EXT” (see § 4.3.10)
- Long pressing (>2s) for the activation of zeroing for measurements of moisture of materials with in-built sensor “MOI INT” (see § 5.2)
- Display of Maximum and Minimum values for infrared temperature measurement (IRT) (see § 5.3)
- Activation of measurement of steam pressure in measuring mode Condensation (see § 5.4)
- Deactivation of Auto Power OFF (APO) function (see § 4.3.11)

4.3.7. Key IRT/▲

Pressing key **IRT/▲** allows activating the infrared temperature measurement (IRT) (see § 5.3). The value of temperature is shown on the secondary display and symbol “▲” appears on the display. Pressing and holding key **IRT/▲** allows for the activation of the laser pointer.

4.3.8. Key MEM/ALM

Pressing key **MEM/ALM** allows for the following operations:

- Saving the result in the internal memory, recalling to the display and deletion of the memory (see § 4.3.9)
- Setting the values of Maximum (HIGH) and Minimum (LOW) thresholds in alarm conditions for measurements of air humidity “%RH” (see § 5.1) and moisture of materials with in-built sensor “MOI INT” and with external probe “MOI EXT” (see § 5.2)

4.3.9. Operations with the memory

The instrument allows saving measured values in its internal memory (max 20 locations), recalling the saved data to the display and deleting the memory.

Saving measurements

1. With the result shown on the display (see Fig. 3 – left side), press and hold (>2s) key **MEM/ALM** until the instrument gives out a sound.

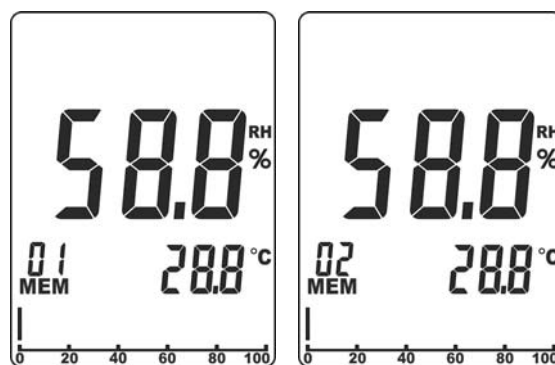

Fig. 3: Storage of measurement results

2. The measured value is saved in the location indicated at the bottom of the display (see Fig. 2 – part 15) and the instrument automatically shows the next available location (see Fig. 3 – right side)

Recalling results to the display

1. Press keys ◀ and ▶ at the same time. The indication of the current memory location (see Fig. 2 – part 15) flashes on the display.
2. Use keys ◀ or ▶ to change the value of memory location (from 01 to 20) to recall the corresponding result to the display.
3. Press key **MEM/ALM** to quit the section and go back to normal measurement display.

Deleting the internal memory

1. Press keys ◀ and ▶ at the same time. The indication of the current memory location (see Fig. 4 – left side) flashes on the display.

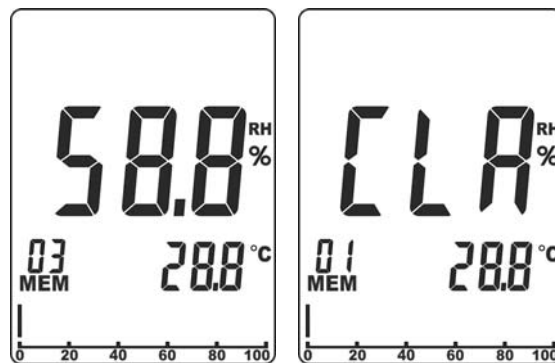

Fig. 4: Deleting the internal memory

2. Press and hold keys ◀ and **MEM/ALM** at the same time for at least 3s. The message “CLR” appears on the display and the memory location is automatically brought back to “01” (see Fig. 4 – right side).

4.3.10. Setting of alarm thresholds on measurements

in measurements of air relative humidity “%RH” and of moisture of materials with contact “MOI INT” and “MOI EXT”, you can set alarm conditions as follows:

Measurement of humidity %RH

1. Press and hold keys **RH%** and **MODE/ZERO** at the same time for a few seconds. The symbol “HIGH” is shown on the top of the display (see Fig. 5 – left side).

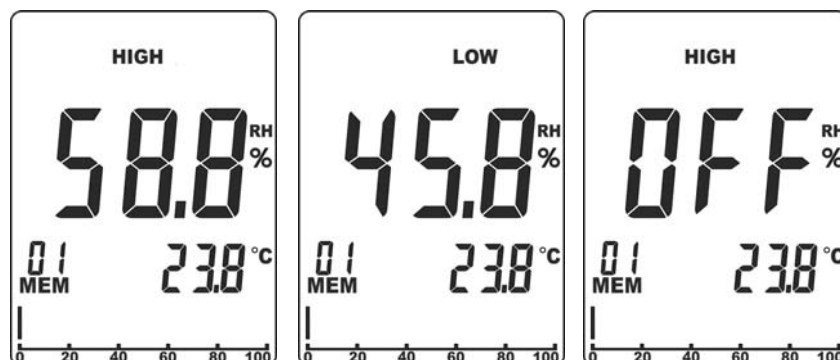

Fig. 5: Setting of alarm thresholds for %RH measurement

2. Use the arrow keys ◀ or ▶ to set the value of Maximum threshold in range: **0.1% ÷ 99.9%**. In these conditions, the instrument will give out an **intermittent** sound when the measured value of humidity is higher than the set threshold. Select option “**OFF**” to disable the alarm (see Fig. 5 – right side)
3. Press key **MEM/ALM** to confirm and go to the setting of the Minimum threshold. The symbol “**LOW**” is shown on the top of the display (see Fig. 5 – middle).
4. Use the arrow keys ◀ or ▶ to set the value of Minimum threshold in range: **0.1% ÷ 99.9%**. In these conditions, the instrument will give out an **intermittent** sound when the measured value of humidity is lower than the set threshold. Select option “**OFF**” to disable the alarm.
5. Press key **MEM/ALM** to confirm and quit the setting section and go back to real-time measurement display.

Measurement of humidity MOI INT and MOI EXT



CAUTION

Alarm settings defined in mode MOI INT are automatically used by the instrument also in mode MOI EXT.

1. Press and hold keys **RH%** and **MODE/ZERO** at the same time for a few seconds. The symbol “**HIGH**” is shown on the top of the display (see Fig. 6 – left side).

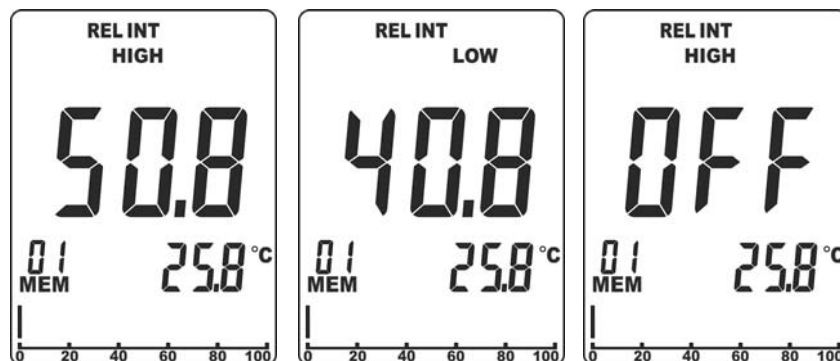

Fig. 6: Setting of alarm thresholds for MOI INT and MOI EXT measurement

2. Use the arrow keys ◀ or ▶ to set the value of Maximum threshold in range: **0.1% ÷ 99.9%**. In these conditions, the instrument will give out a **continuous** sound when the measured value of humidity is higher than the set threshold. Select option “**OFF**” to disable the alarm (see Fig. 6 – right side)
3. Press key **MEM/ALM** to confirm and go to the setting of the Minimum threshold. The symbol “**LOW**” is shown on the top of the display (see Fig. 6 – middle).
4. Use the arrow keys ◀ or ▶ to set the value of Minimum threshold in range: **0.1% ÷ 99.9%**. In these conditions, the instrument will give out an **intermittent** sound when the measured value of humidity is higher than the set threshold. Select option “**OFF**” to disable the alarm.
5. Press key **MEM/ALM** to confirm and quit the setting section and go back to real-time measurement display.

4.3.11. Disabling the Auto Power OFF function

The instrument is provided with a device (APO) which switches it off automatically after 30 minutes' idling, in order to preserve the instrument's internal battery. The instrument gives out a sound for approx. 15s before entering the auto power off mode. To disable this function:

1. Switch off the instrument using key **ON/OFF**.
2. Press and hold key **MODE** and switch on the instrument using key **ON/OFF**. Symbol "APO" (see Fig. 2 – part 4) disappears from the display.
3. Switch off and then on again the instrument to automatically activate the function again.

5. OPERATING INSTRUCTIONS

5.1. MEASUREMENT OF AIR TEMPERATURE AND HUMIDITY



CAUTION

Do not carry out any measurements in case gas, explosive materials or flammables are present, or in dusty environments. Do not expose the in-built sensor to mechanical shocks.

1. Switch on the instrument using key **ON/OFF**.
2. Use keys ◀ or ▶ to select the measuring unit for temperature (see § 4.3.3).
3. Position the in-built sensor (see Fig. 1 – part 1) in the environment in which tests are performed. The value of temperature in real time is shown on the secondary display, while the value of relative humidity (%RH) in real time is shown on the main display. Value “- - -” indicates that the maximum measurable values have been exceeded. The analogue bargraph is not active in this function.



Fig. 7: Use of the instrument for measuring air temperature/humidity

4. Press key **MODE/ZERO** to select measurement of dew point temperature and specific humidity expressed in “g/kg” or “GPP” (see § 4.3.6). The value of dew point temperature is shown on the secondary display (see Fig. 7 – right side).
5. Set possible alarm conditions on measurement (see § 4.3.10).
6. Wait for a steady result on the display and press key **MEM/ALM** to save the measured result in the instrument's internal memory (see § 4.3.9).

5.2. MOISTURE MEASUREMENT OF MATERIALS

The instrument can perform moisture measurements with contact (typically wood and construction materials) in the following modes:

- MOI INT → Use of the in-built sensor (see Fig. 1 – part 12) rested against the surface to be tested.
- MOI EXT → Use of the provided external probe inserted in the instrument's side input connector (see Fig. 1 – part 14).

5.2.1. Measurement with in-built sensor



CAUTION

Do not carry out any measurements in case gas, explosive materials or flammables are present, or in dusty environments. Do not expose the in-built sensor to mechanical shocks.

1. Switch on the instrument using key **ON/OFF**.
2. Use keys ◀ or ▶ to select the measuring unit for temperature (see § 4.3.3).
3. Press key **MOI**. Indication “MOIST REL INT” appears at the top of the display.

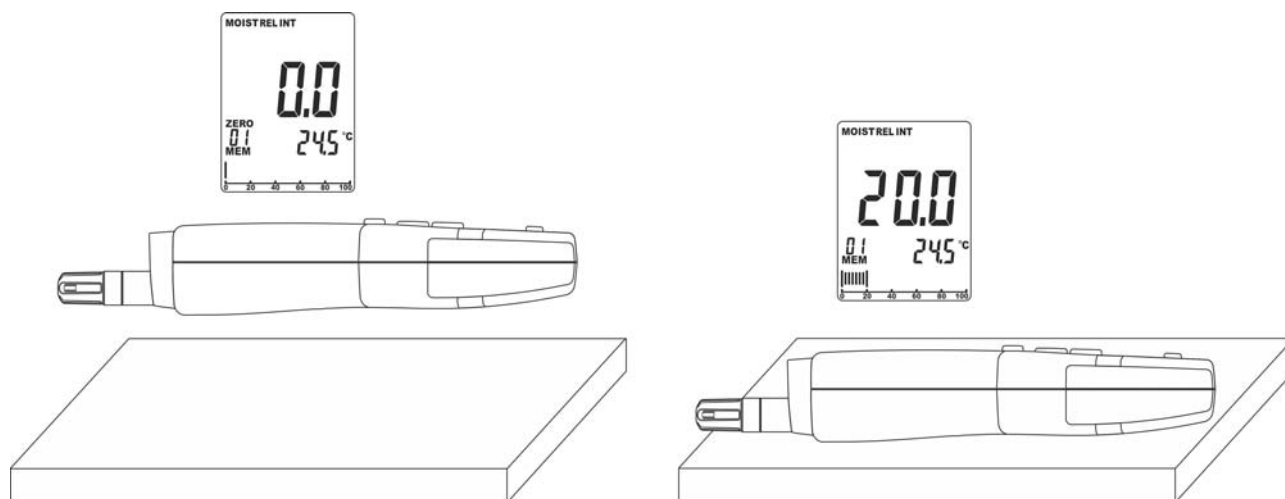

Fig. 8: Use of the instrument for measuring moisture with contact with the in-built sensor

4. Position the in-built sensor near the surface of the item to be measured, paying attention not to cover it with your hand, and check that the main display shows value “0.0”
5. In case the value is not zeroed, press and hold (>2s) key **MODE/ZERO**. Symbol “ZERO” appears on the display for a moment and the value is zeroed on the main display (see Fig. 8 – left side).
6. Rest the instrument on the surface of the item to be measured. The value of relative humidity is shown on the main display. The value of air temperature is shown on the secondary display.
7. Set possible alarm conditions on measurement (see § 4.3.10).
8. Wait for a steady result on the display and press key **MEM/ALM** to save the measured result in the instrument's internal memory (see § 4.3.9).

5.2.2. Measurement with external probe



CAUTION

Do not carry out any measurements in case gas, explosive materials or flammables are present, or in dusty environments. Do not expose the in-built sensor to mechanical shocks.

1. Switch on the instrument using key **ON/OFF**.
2. Use keys ◀ or ▶ to select the measuring unit for temperature (see § 4.3.3).
3. Press key **MOI** until "MOIST REL EXT" is shown at the top of the display.

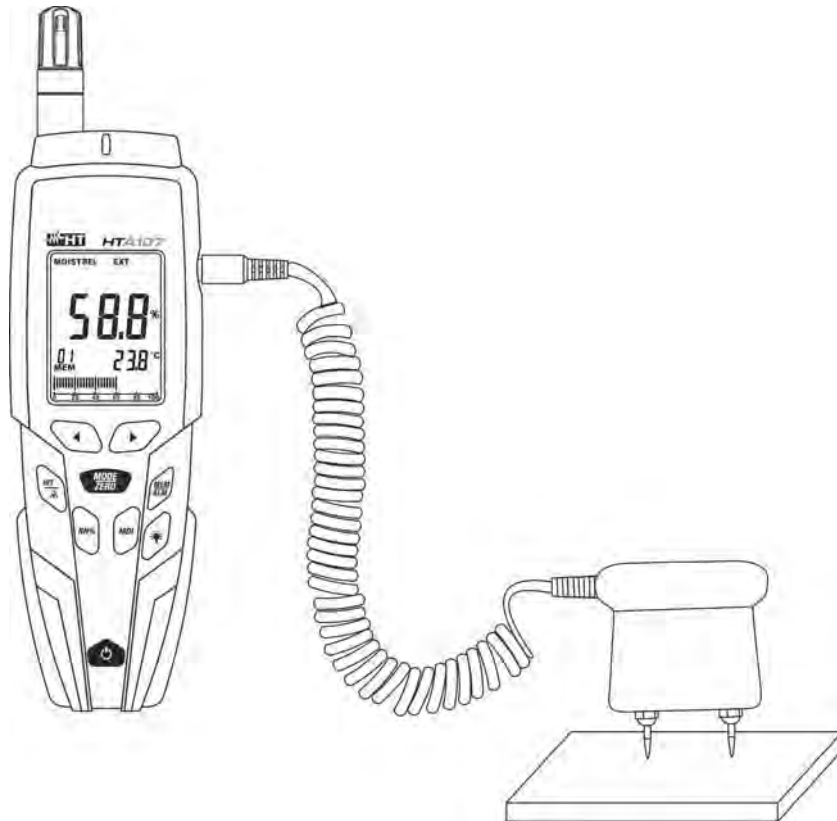

Fig. 9: Use for measuring moisture with contact by means of the external probe.

4. Insert the provided external probe into the input connector on the side of the instrument (see Fig. 1 – part 14).
5. Rest the probe's terminals on the surface of the item to be measured (see Fig. 9).. The value of relative humidity is shown on the main display. The value of air temperature is shown on the secondary display.
6. Set possible alarm conditions on measurement (see § 4.3.10).
7. Wait for a steady result on the display and press key **MEM/ALM** to save the measured result in the instrument's internal memory (see § 4.3.9).

5.3. INFRARED TEMPERATURE MEASUREMENT

The instrument can perform infrared temperature measurements (IRT) on surfaces by means of the sensor found on its upper side (see Fig. 1 – part 15). Measurement is performed by activating a laser pointer (see Fig. 1 – part 16). This measurement can be performed together with air temperature and humidity measurements,

1. Switch on the instrument using key **ON/OFF**.
2. Use keys ◀ or ▶ to select the measuring unit for temperature (see § 4.3.3).
3. Air temperature is shown on the secondary display (see Fig. 10 – left side).
4. Press key **IRT/▲** to activate IRT measurement. The laser pointer activates for a moment and symbol “▲” appears on the display until measurement is completed. The value of IRT temperature is shown on the secondary display for approx. 15s (see Fig. 10 – right side) and, subsequently, the instrument automatically goes back to air temperature measurement.
5. Press and hold key **IRT/▲** to perform IRT measurement continuously.

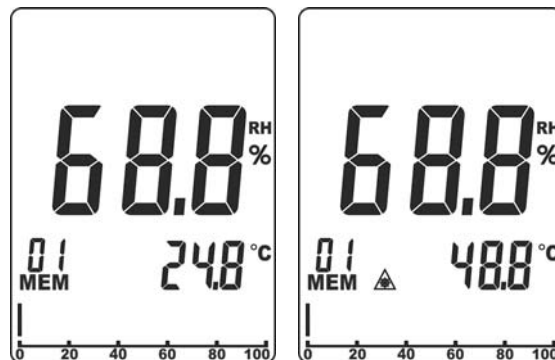

Fig. 10: Infrared temperature measurement (IRT)

6. Press key **MODE/ZERO** during IRT measurement in order to measure the Maximum (symbol “MAX” on the display) or Minimum (symbol “MIN” on the display) value of IRT temperature. Press and hold key **IRT/▲** to perform MAX or MIN measurement continuously.
7. Wait for a steady result on the display and press key **MEM/ALM** to save the measured result in the instrument's internal memory (see § 4.3.9).

5.4. MEASUREMENT OF SURFACE TEMPERATURE DIFFERENCE

The instrument can use both the in-built sensor (see Fig. 1 – part 1) and the IRT sensor (see Fig. 1 – part 15) to determine whether a surface has a risk of condensation or not.



CAUTION

Do not carry out any measurements in case gas, explosive materials or flammables are present, or in dusty environments. Do not expose the in-built sensor to mechanical shocks.

1. Switch on the instrument using key **ON/OFF**.
2. Use keys ◀ or ▶ to select the measuring unit for temperature (see § 4.3.3).

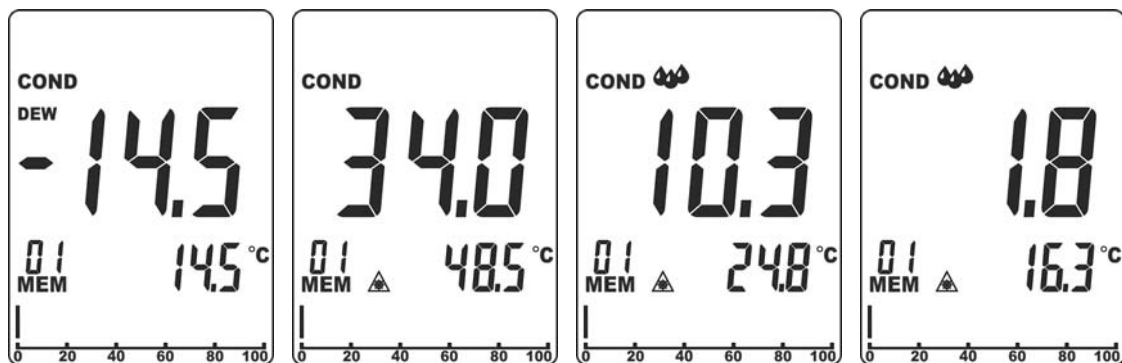

Fig. 11: Measurement of surface temperature difference

3. Press keys **RH%** and **MOI** at the same time to enter the Condensation measuring mode. The instrument shows the value of dew point temperature measured by the in-built sensor on the secondary display and indications “COND” and “DEW” appear on the display (see Fig. 11 – first screen). The main display always shows the difference between the value of IRT temperature and dew point temperature.
4. Press key **IRT/▲** to measure IRT temperature on the surface to be tested. The value of temperature is shown on the secondary display for a few seconds and symbol “▲” appears on the display. The instrument behaves as follows:
 - If IRT temperature is **higher** than dew point temperature → **by more than 14°C (25°F)**, temperature difference (IRT-DP) is shown on the main display with no further indications (see Fig. 11 – second screen).
 - If IRT temperature is **higher** than dew point temperature → **by 3°C÷14°C (5°F÷25°F)**, temperature difference (IRT-DP) is shown on the main display, indication “▲” appears on the display and the instrument gives out a sound to indicate a risk of condensation in the area (see Fig. 11 – third screen).
 - If IRT temperature is **higher** than dew point temperature → **by less than 3°C (5°F)**, temperature difference (IRT-DP) is shown on the main display, indication “▲▲” appears on the display and the instrument gives out a double sound to indicate a high risk of condensation in the area (see Fig. 11 – fourth screen).
5. Press key **MODE/ZERO** to activate/deactivate the display of steam pressure expressed in “kPA” (for temp. meas. unit °C) or in “mBAR” (for °F) at the top of the display
6. Wait for a steady result on the display and press key **MEM/ALM** to save the measured result in the instrument’s internal memory (see § 4.3.9).
7. Press key **RH%** or key **MOI** to quit Condensation mode.

6. MAINTENANCE

6.1. GENERAL INFORMATION

While using and storing the instrument, carefully observe the recommendations listed in this manual in order to prevent possible damage or danger during use. Do not use the instrument in environments with high humidity levels or high temperatures. Do not expose to direct sunlight. Always switch off the instrument after use. In case the instrument is not to be used for a long time, remove the battery to avoid liquid leaks that could damage the instrument's internal circuits.

6.2. REPLACING THE BATTERY

When the display shows symbol , it is necessary to replace the battery.



CAUTION

Only expert technicians should perform this operation. Before carrying out this operation, make sure you have removed the probe from the input terminal.

1. Switch off the instrument.
2. Remove the battery compartment cover (see Fig. 1 – part 13).
3. Disconnect the battery from the connector.
4. Connect the new battery to the connector, and pay attention to correct polarity.
5. Restore the battery compartment cover to its position.
6. Do not scatter old batteries into the environment. Use the relevant containers for battery disposal.

6.3. CLEANING THE INSTRUMENT

Use a soft and dry cloth to clean the instrument. Never use wet cloths, solvents, water, etc.

6.4. END OF LIFE



WARNING: this symbol found on the instrument indicates that the appliance, its accessories and the battery must be collected separately and correctly disposed of.

7. TECHNICAL SPECIFICATIONS

7.1. TECHNICAL CHARACTERISTICS

Accuracy calculated as \pm [indication] at 25°C, <70%RH

Air temperature with in-built sensor

Range	Resolution	Accuracy
-28.0°C ÷ 77.0°C	0.1 °C	±2.0°C
-20.0°F ÷ 170.0°F	0.1 °F	±3.6°F

Air relative humidity

Range [%RH]	Resolution [%RH]	Accuracy (*)
0.0 ÷ 10.0	0.1%RH	±3.0%reading
11.0 ÷ 90.0		±2.0%reading
91.0 ÷ 99.9		±3.0%reading

(*) Relevant to the temperature range: 20°C ÷ 30°C (68°F ÷ 86°F)

Infrared temperature

Measuring range	-50.0°C ÷ 200.0°C (-58.0°F ÷ 392.0°F)
Accuracy	±5°C / ±9°F (-50°C ÷ -20°C) / (-58°F ÷ -4°F) ±2.0%reading or ±2°C / ±4°F (-20°C ÷ -1°C) / (-4°F ÷ 31°F) ±1.0%reading or ±0.6°C / ±1°F (0°C / 32°F) ±2.0%reading or ±2°C / ±3°F (1°C ÷ 200°C) / (33°F ÷ 392°F)
Response time	<500ms
Resolution	0.1°C / 0.1°F
Emissivity range	0.95 (fixed)
Distance/Spot ratio	D/S = 8:1
Laser pointer	<1mW, class 2 according to IEC 60825-1

7.1.1. General characteristics

Mechanical characteristics

Size (L x W x H):	230 x 65 x 45mm
Length of external probe cable:	0.9m (3ft)
Weight (battery included):	250g
Mechanical protection:	IP40

Power supply

Battery type:	1x9V alkaline battery type NEDA 1604 IEC 6F22 JIS 006P
Low battery indication:	symbol "⎓" on the display
Battery duration:	ca 16 hours (backlight ON), ca 45 hours (backlight OFF)
Out-of-range indication:	message "- - -" on the display
Auto Power OFF:	after 30 minutes' idling (may be disabled)

Internal memory	max 20 locations
------------------------	------------------

Display

Characteristics:	2 displays, 4 LCD decimal sign, point, backlight and bargraph
Updating frequency:	3times/s

7.2. ENVIRONMENT

7.2.1. Environmental conditions for use

Reference temperature:	25°C
Operating temperature:	-10°C ÷ 50°C (14°F ÷ 122°F)
Allowable relative humidity:	<90%RH (0°C÷30°C);<75%RH(30°C÷40°C) <45%RH (40°C÷50°C)
Storage temperature:	-30°C ÷ 60°C (-14°F ÷ 140°F)
Storage humidity:	<90%RH
Max operating altitude:	2000m

**This instrument complies with European Directive EMC 2014/30/EU
This instrument satisfies the requirements of European Directive 2011/65/EU
(RoHS) and 2012/19/EU (WEEE).**

7.3. ACCESSORIES

7.3.1. Accessories provided

- External probe
- Battery
- Transport case
- User manual

8. ASSISTANCE

8.1. WARRANTY CONDITIONS

This instrument is warranted against any material or manufacturing defect, in compliance with the general sales conditions. During the warranty period, defective parts may be replaced. However, the manufacturer reserves the right to repair or replace the product. Should the instrument be returned to the After-sales Service or to a Dealer, transport will be at the Customer's charge. However, shipment will be agreed in advance. A report will always be enclosed to a shipment, stating the reasons for the product's return. Only use original packaging for shipment; any damage due to the use of non-original packaging material will be charged to the Customer. The manufacturer declines any responsibility for injury to people or damage to property.

The warranty shall not apply in the following cases:

- Repair and/or replacement of accessories and batteries (not covered by warranty)
- Repairs that may become necessary as a consequence of an incorrect use of the instrument or due to its use together with non-compatible appliances.
- Repairs that may become necessary as a consequence of improper packaging.
- Repairs which may become necessary as a consequence of interventions performed by unauthorized personnel.
- Modifications to the instrument performed without the manufacturer's explicit authorization.
- Use not provided for in the instrument's specifications or in the instruction manual.

The content of this manual cannot be reproduced in any form without the manufacturer's authorization.

Our products are patented and our trademarks are registered. The manufacturer reserves the right to make changes in the specifications and prices if this is due to improvements in technology.

8.2. ASSISTANCE

If the instrument does not operate properly, before contacting the After-sales Service, please check the conditions of the battery and replace it, if necessary. Should the instrument still operate improperly, check that the product is operated according to the instructions given in this manual. Should the instrument be returned to the After-sales Service or to a Dealer, transport will be at the Customer's charge. However, shipment will be agreed in advance. A report will always be enclosed to a shipment, stating the reasons for the product's return. Only use original packaging for shipment; any damage due to the use of non-original packaging material will be charged to the Customer.