

ENGLISH

User manual



TABLE OF CONTENTS

1. PRECAUTIONS AND SAFETY MEASURES	2
1.1. Preliminary instructions	2
1.2. During use	3
1.3. After use	3
1.4. Definition of Measurement (Overvoltage) category	3
2. GENERAL DESCRIPTION	4
2.1. Measuring average values and TRMS values	4
2.2. Definition of true root mean square value and Crest factor	4
3. PREPARATION FOR USE	5
3.1. Initial checks	5
3.2. Instrument power supply	5
3.3. Storage	5
4. NOMENCLATURE	6
4.1. Description of the instrument	6
4.2. Description of function keys	7
4.2.1. HOLD/⏻ key	7
4.2.2. RANGE key	7
4.2.3. REL key	7
4.2.4. MODE key	7
4.2.5. LoZ feature	7
4.2.6. Disabling the Auto Power Off function	7
5. OPERATING INSTRUCTIONS	8
5.1. DC Voltage measurement	8
5.2. AC Voltage measurement	9
5.3. AC/DC Voltage measurement with low impedance (LoZ)	10
5.4. Frequency and Duty Cycle measurement	11
5.5. Resistance measurement and Continuity test	12
5.6. Diode test	13
5.7. Capacitance measurement	14
5.8. Temperature measurement with K-type probe	15
5.9. DC Current measurement with transducer clamps	16
5.10. AC Current measurement with transducer clamps	17
6. MAINTENANCE	18
6.1. Replacing battery	18
6.2. Cleaning the instrument	18
6.3. End of life	18
7. TECHNICAL SPECIFICATIONS	19
7.1. Technical characteristics	19
7.1.1. Reference standards	21
7.1.2. General characteristics	21
7.2. Environment	22
7.2.1. Environmental conditions for use	22
7.3. Accessories	22
7.3.1. Accessories provided	22
7.3.2. Optional accessories	22
8. ASSISTANCE	23
8.1. Warranty conditions	23
8.2. Assistance	23

1. PRECAUTIONS AND SAFETY MEASURES

The instrument has been designed in compliance with directive IEC/EN61010-1 relevant to electronic measuring instruments. For your safety and in order to prevent damaging the instrument, please carefully follow the procedures described in this manual and read all notes preceded by symbol  with the utmost attention.

Before and after carrying out measurements, carefully observe the following instructions:

- Do not carry out any measurement in humid environments.
- Do not carry out any measurements in case gas, explosive materials or flammables are present, or in dusty environments.
- Avoid any contact with the circuit being measured if no measurements are being carried out.
- Avoid any contact with exposed metal parts, with unused measuring probes, circuits, etc.
- Do not carry out any measurement in case you find anomalies in the instrument such as deformation, breaks, substance leaks, absence of display on the screen, etc.
- Pay special attention when measuring voltages higher than 20V, since a risk of electrical shock exists.

In this manual, and on the instrument, the following symbols are used:



Warning: observe the instructions given in this manual; improper use could damage the instrument or its components.



Double-insulated meter



AC voltage or current



DC voltage or current



Connection to earth

1.1. PRELIMINARY INSTRUCTIONS

- This instrument has been designed for use in environments of pollution degree 2.
- It can be used for **VOLTAGE** and **CURRENT** measurements on installations with CAT IV 600V and CAT III 1000V.
- We recommend following the normal safety rules devised by the procedures for carrying out operations on live systems and using the prescribed PPE to protect the user against dangerous currents and the instrument against incorrect use.
- In case the lack of indication of the presence of voltage may represent a danger for the operator, always carry out a continuity measurement before carrying out the measurement on the live system, in order to confirm the correct connection and condition of the leads.
- Only the leads supplied with the instrument guarantee compliance with the safety standards. They must be in good conditions and be replaced with identical models, when necessary.
- Do not test circuits exceeding the specified voltage limits.
- Do not perform any test under environmental conditions exceeding the limits indicated in § 6.2.1.
- Check that the battery is correctly inserted.
- Make sure that the LCD display and the rotary switch indicate the same function.

1.2. DURING USE

Please carefully read the following recommendations and instructions:



CAUTION

Failure to comply with the caution notes and/or instructions may damage the instrument and/or its components or be a source of danger for the operator.

- Before activating the rotary switch, disconnect the test leads from the circuit being measured.
- When the instrument is connected to the circuit being measured, do not touch any unused terminal.
- Do not measure resistance in case external voltages are present; even if the instrument is protected, an excessive voltage may cause malfunction.
- While measuring, if the value or the sign of the quantity being measured remain unchanged, check if the HOLD function is enabled.

1.3. AFTER USE

- When measurement is complete, set the rotary switch to OFF to turn off the instrument.
- If the instrument is not to be used for a long time, remove the batteries.

1.4. DEFINITION OF MEASUREMENT (OVERVOLTAGE) CATEGORY

Standard "IEC/EN61010-1: Safety requirements for electrical equipment for measurement, control and laboratory use, Part 1: General requirements", defines what measurement category, commonly called overvoltage category, is. § 6.7.4: Measured circuits, reads:

(OMISSIS)

Circuits are divided into the following measurement categories:

- **Measurement category IV** is for measurements performed at the source of the low-voltage installation.
Examples are electricity meters and measurements on primary overcurrent protection devices and ripple control units.
- **Measurement category III** is for measurements performed on installations inside buildings.
Examples are measurements on distribution boards, circuit breakers, wiring, including cables, bus-bars, junction boxes, switches, socket-outlets in the fixed installation, and equipment for industrial use and some other equipment, for example, stationary motors with permanent connection to fixed installation.
- **Measurement category II** is for measurements performed on circuits directly connected to the low-voltage installation.
Examples are measurements on household appliances, portable tools and similar equipment.
- **Measurement category I** is for measurements performed on circuits not directly connected to MAINS.
Examples are measurements on circuits not derived from MAINS, and specially protected (internal) MAINS-derived circuits. In the latter case, transient stresses are variable; for that reason, the standard requires that the transient withstand capability of the equipment is made known to the user.

2. GENERAL DESCRIPTION

The instrument carries out the following measurements:

- DC Voltage up to 1500V
- AC TRMS Voltage up to 1000V
- DC/AC TRMS Voltage with low impedance (LoZ)
- DC/AC TRMS Current with transducer clamps
- Resistance and Continuity test
- Diode test
- Capacity
- Current and voltage frequency
- Duty Cycle
- Temperature with K-type probe

Each of these functions can be selected by means of the appropriate switch. The instrument is also equipped with function keys (see § 4.2) and backlight. The instrument is also equipped with an Auto Power OFF function (which can be disabled), which automatically switches off the instrument 15 minutes after the last time a function key was pressed or the rotary switch was turned. To switch on the instrument again, turn the rotary switch.

2.1. MEASURING AVERAGE VALUES AND TRMS VALUES

Measuring instruments of alternating quantities are divided into two big families:

- AVERAGE-VALUE meters: instruments measuring the value of the sole wave at fundamental frequency (50 or 60 Hz).
- TRMS (True Root Mean Square) VALUE meters: instruments measuring the TRMS value of the quantity being tested.

With a perfectly sinusoidal wave, the two families of instruments provide identical results. With distorted waves, instead, the readings shall differ. Average-value meters provide the RMS value of the sole fundamental wave; TRSM meters, instead, provide the RMS value of the whole wave, including harmonics (within the instruments bandwidth). Therefore, by measuring the same quantity with instruments from both families, the values obtained are identical only if the wave is perfectly sinusoidal. In case it is distorted, TRMS meters shall provide higher values than the values read by average-value meters.

2.2. DEFINITION OF TRUE ROOT MEAN SQUARE VALUE AND CREST FACTOR

The root mean square value of current is defined as follows: *"In a time equal to a period, an alternating current with a root mean square value of 1A intensity, circulating on a resistor, dissipates the same energy that, during the same time, would be dissipated by a direct current with an intensity of 1A"*. This definition results in the numeric expression:

$$G = \sqrt{\frac{1}{T} \int_{t_0}^{t_0+T} g^2(t) dt}$$

The root mean square value is indicated with the acronym RMS.

The Crest Factor is defined as the relationship between the Peak Value of a signal and its

RMS value: $CF (G) = \frac{G_p}{G_{RMS}}$ This value changes with the signal waveform, for a purely

sinusoidal wave it is $\sqrt{2} = 1.41$. In case of distortion, the Crest Factor takes higher values as wave distortion increases.

3. PREPARATION FOR USE

3.1. INITIAL CHECKS

Before shipping, the instrument has been checked from an electric as well as mechanical point of view. All possible precautions have been taken so that the instrument is delivered undamaged. However, we recommend generally checking the instrument in order to detect possible damage suffered during transport. In case anomalies are found, immediately contact the forwarding agent. We also recommend checking that the packaging contains all components indicated in § 6.3.1. In case of discrepancy, please contact the Dealer. In case the instrument should be returned, please follow the instructions given in § 7.

3.2. INSTRUMENT POWER SUPPLY

The instrument is supplied with 1x9V alkaline battery type IEC 6F22, included in the package. When battery is flat, the symbol  appears on the display. To replace the battery, see § 6.1.

3.3. STORAGE

In order to guarantee precise measurement, after a long storage time under extreme environmental conditions, wait for the instrument to come back to normal condition (see § 6.2.1).

4. NOMENCLATURE

4.1. DESCRIPTION OF THE INSTRUMENT

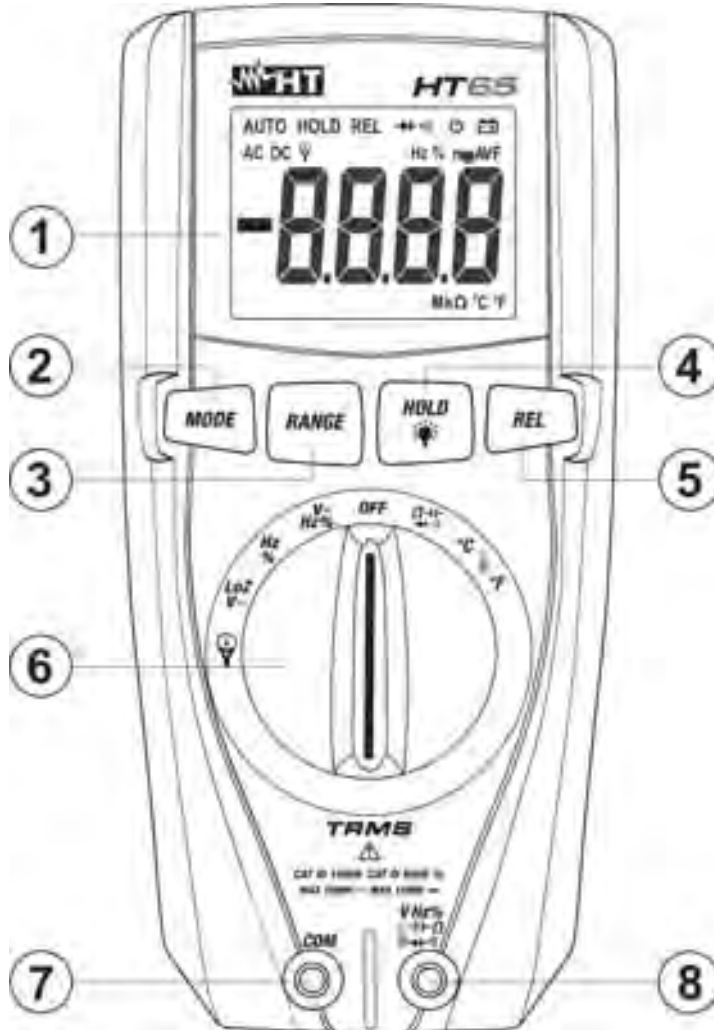

CAPTION:

1. LCD display
2. **MODE** key
3. **RANGE** key
4. **HOLD/** key
5. **REL** key
6. Rotary selector switch
7. Input terminal **COM**
8. Input terminal

Fig. 1: Description of the instrument

4.2. DESCRIPTION OF FUNCTION KEYS

4.2.1. HOLD/🔒 key

Pressing the **HOLD/🔒** key freezes the value of the measured quantity on the display. After pressing this key, the message "HOLD" appears on the display. Press the **HOLD/🔒** key again to exit the function. Press and hold the same key for longer than one second to activate and deactivate the display's backlight. This function is active in any position of the rotary switch.

4.2.2. RANGE key

Press the **RANGE** key to activate the manual mode and to disable the Autorange function. The symbol "AUTO" disappears from the upper left part of the display. In manual mode, press the **RANGE** key to change measuring range: the relevant decimal point will change its position. The **RANGE** key is not active in positions $\rightarrow \rightarrow \rightarrow \rightarrow \rightarrow$), Hz% and $\text{m}^\circ\text{C}^\circ\text{F}$. In Autorange mode, the instrument selects the most appropriate ratio for carrying out measurement. If a reading is higher than the maximum measurable value, the indication "O.L" appears on the display. Press and hold the **RANGE** key for more than 1 second to exit the manual mode and restore the Autorange mode.

4.2.3. REL key

Press the **REL** key to activate relative measurement. The instrument zeroes the display and saves the displayed value as a reference value which subsequent measurements will be referred to. The symbol "REL" appears on the display. This function is not active in position $\rightarrow \rightarrow \rightarrow \rightarrow \rightarrow$), Hz% and $\text{m}^\circ\text{C}^\circ\text{F}$. Press the key again to exit the function.

4.2.4. MODE key

Pressing the **MODE** key allows selecting a double function on the rotary switch. In particular, it is active in position $\Omega \rightarrow \rightarrow \rightarrow \rightarrow \rightarrow$) to select diode test, continuity test, capacitance measurement and resistance measurement, in position $\text{V} \sim \text{Hz}\%$, $\text{mV} \sim$, $\text{LoZV} \sim$ (see § 4.2.5) and m to select AC or DC measurements. In position Hz%, pressing the **MODE** key activates/deactivates the frequency (Hz) or duty cycle (%) measurements of electronic signals (different respect the same of $\text{V} \sim \text{Hz}\%$ position)

4.2.5. LoZ feature

This mode permits to perform the AC/DC voltage measurement with a low input impedance in way to avoid the wrong readings due to stray voltage in capacitive coupled.



CAUTION

Inserting the instrument between phase and ground conductors, the RCDs protection devices can be tripping out during the test. For phase-PE voltage measurement after a RCD device preliminarily connect the test leads between phase and neutral cables at least for 5s, then perform the phase-PE measurement to avoid unexpected trips-out.

4.2.6. Disabling the Auto Power Off function

In order to preserve internal batteries, the instrument switches off automatically approximately 15 minutes after it was last used. To disable the Auto Power Off function, proceed as follows:

- Switch off the instrument (**OFF**)
- Press and hold the **MODE** key and switch on the instrument by turning the rotary switch. The instrument emits quick sounds and the "🔒" symbol disappears on the display.
- Switch off and then on again the instrument to enable the function.

5. OPERATING INSTRUCTIONS

5.1. DC VOLTAGE MEASUREMENT



CAUTION

- The maximum input DC voltage is 1500V. Do not measure voltages exceeding the limits given in this manual. Exceeding voltage limits could result in electrical shocks to the user and damage to the instrument
- **The CAT III 1000V mark on test leads guarantees a safe measurement of voltage up to 1500V**



Fig. 2: Use of the instrument for DC Voltage measurement

1. Select positions $V \text{---} \text{Hz} \%$
2. Press the **MODE** key to display the "DC" symbol on the display
3. Insert the red cable into input terminal $V \text{---} \text{Hz} \%$ and the black cable into input terminal **COM**.
4. Position the red lead and the black lead respectively in the spots with positive and negative potential of the circuit to be measured (see Fig. 2). The display shows the value of voltage.
5. If the display shows the message "OL", select a higher range.
6. When symbol "-" appears on the instrument's display, it means that voltage has the opposite direction with respect to the connection in Fig. 2.
7. To use the HOLD, RANGE and REL functions, see § 4.2

5.2. AC VOLTAGE MEASUREMENT

CAUTION



The maximum input AC voltage is 1000V. Do not measure voltages exceeding the limits given in this manual. Exceeding voltage limits could result in electrical shocks to the user and damage to the instrument.



Fig. 3: Use of the instrument for AC voltage measurement

1. Select positions **V \sim Hz%**
2. Insert the red cable into input terminal **Hz%V** and the black cable into input terminal **COM**.
3. Position the red lead and the black lead respectively in the spots of the circuit to be measured (see Fig. 3). The display shows the value of voltage.
4. If the display shows the message "OL", select a higher range.
5. Press and hold the **MODE** key to select measurements "Hz" or "%" in order to display the values of frequency and duty cycle of input voltage. Press and hold again the **MODE** key to go back to voltage measurement
6. To use the HOLD, RANGE and REL functions, see § 4.2

5.3. AC/DC VOLTAGE MEASUREMENT WITH LOW IMPEDANCE (LOZ)



CAUTION

The maximum input AC/DC voltage is 600V. Do not measure voltages exceeding the limits given in this manual. Exceeding voltage limits could result in electrical shocks to the user and damage to the instrument.



Fig. 4: Use of the instrument for AC/DC voltage measurement with low impedance (LoZ)

1. Select position **LoZV** . The "LOZ" symbol is shown
2. Press the **MODE** key to select possibly the "AC" or "DC" measurement
3. Insert the red cable into input terminal and the black cable into input terminal **COM**
4. Position the red lead and the black lead respectively in the desired spots of the circuit to be measured (see Fig. 4) or in the spots with positive and negative potential of the circuit to be measured (see Fig. 2). The display shows the value of voltage.
5. The message "**OL.**" indicates that the value of DC voltage exceeds the maximum measurable value.
6. When symbol "**-**" appears on the instrument's display, it means that voltage has the opposite direction with respect to the connection in Fig. 2
7. To use the HOLD, RANGE and REL functions, see § 4.2

5.4. FREQUENCY AND DUTY CYCLE MEASUREMENT

CAUTION



The maximum input AC voltage is 1000V. Do not measure voltages exceeding the limits given in this manual. Exceeding voltage limits could result in electrical shocks to the user and damage to the instrument.

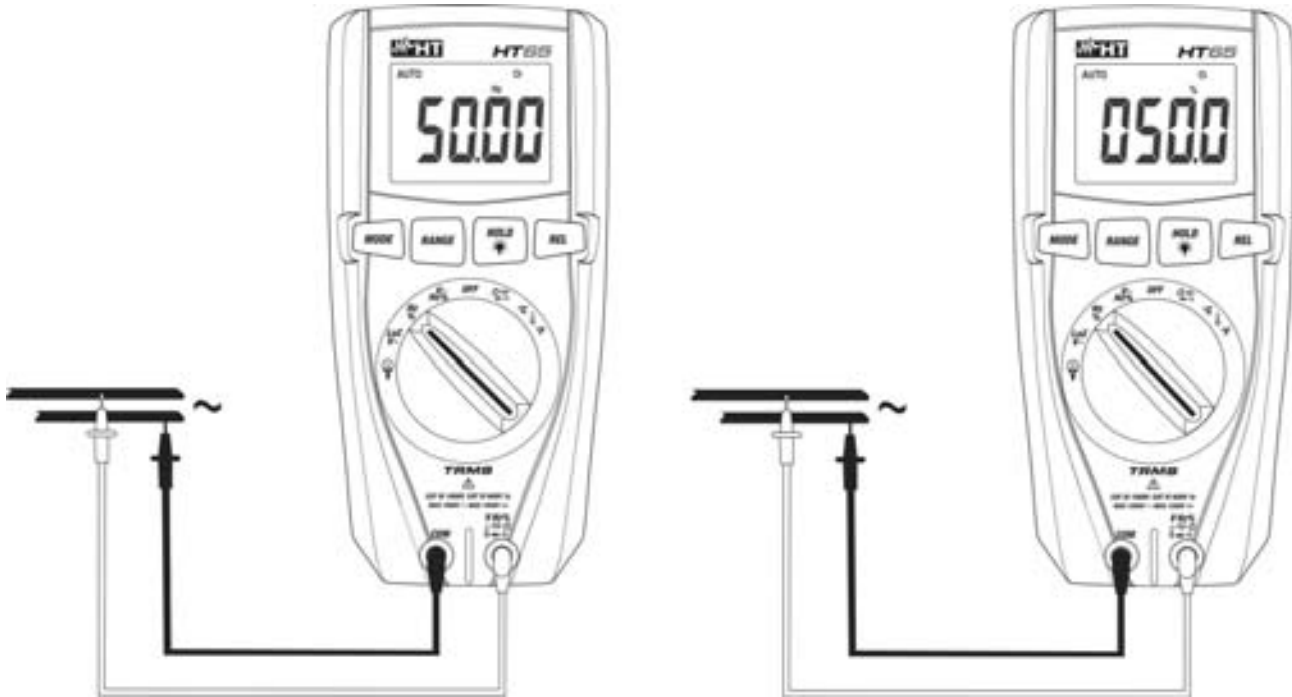

Fig. 5: Use of the instrument for frequency measurement and duty cycle test

1. Select position **Hz%**.
2. Press **MODE** key to select measurements “Hz” or “%” in order to display the values of frequency and duty cycle of input voltage.
3. Insert the red cable into input terminal **Hz%V** and the black cable into input terminal **COM**.
4. Position the red lead and the black lead respectively in the spots of the circuit to be measured (see Fig. 5). The value of frequency (Hz) or of duty cycle (%) is shown on the display
5. To use the HOLD function, see § 4.2

5.5. RESISTANCE MEASUREMENT AND CONTINUITY TEST

CAUTION



Before attempting any resistance measurement, cut off power supply from the circuit to be measured and make sure that all capacitors are discharged, if present.

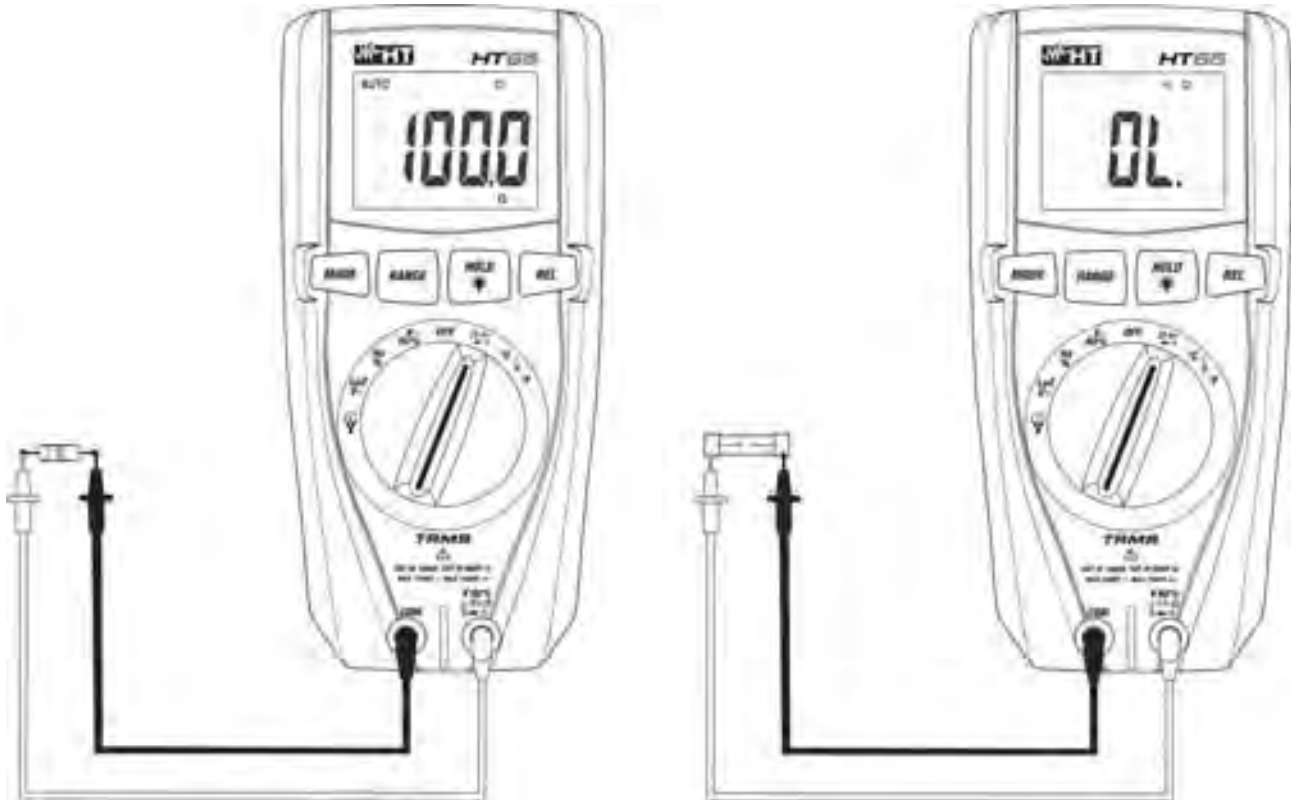

Fig. 6: Use of the instrument for Resistance measurement and Continuity test

1. Select position Ω (resistance symbol)
2. Insert the red cable into input terminal $V\Omega$ and the black cable into input terminal **COM**.
3. Position the test leads in the desired spots of the circuit to be measured (see Fig. 6). The display shows the value of resistance.
4. If the display shows the message "OL", select a higher range.
5. Press the **MODE** key to select \rightarrow measurement, relevant to the continuity test, and position the test leads in the desired spots of the circuit to be measured.
6. The value of resistance (which is only indicative) is displayed in Ω and the instrument sounds if the value of resistance is $<50\Omega$
7. To use the HOLD and RANGE functions, see § 4.2

5.6. DIODE TEST

CAUTION



Before attempting any resistance measurement, cut off power supply from the circuit to be measured and make sure that all capacitors are discharged, if present.

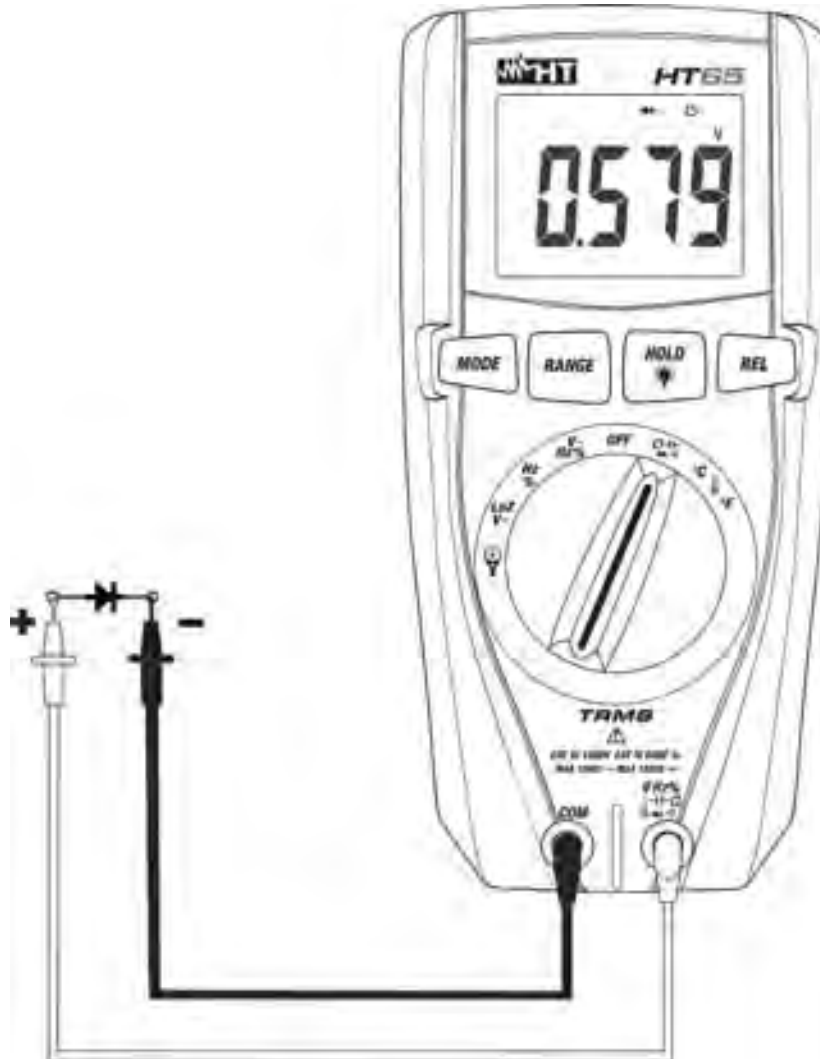

Fig. 7: Use of the instrument for diode test

1. Select position $\Omega \rightarrow \rightarrow \rightarrow$
2. Press the **MODE** key to select “ \rightarrow ” measurement.
3. Insert the red cable into input terminal $\rightarrow \rightarrow \rightarrow$ and the black cable into input terminal **COM**.
4. Position the leads at the ends of the diode to be tested (see Fig. 7), respecting the indicated polarity. The value of directly polarized threshold voltage is shown on the display.
5. If threshold value is equal to 0mV, the P-N junction of the diode is short-circuited.
6. If the display shows the message “**OL**”, the terminals of the diode are reversed with respect to the indication given in Fig. 7 or the P-N junction of the diode is damaged.
7. To use the HOLD function, see § 4.2.

5.7. CAPACITANCE MEASUREMENT



CAUTION

Before carrying out capacitance measurements on circuits or capacitors, cut off power supply from the circuit being tested and let all capacitance in it be discharged. When connecting the multimeter and the capacitance to be measured, respect the correct polarity (when required).



Fig. 8: Use of the instrument for Capacitance measurement

1. Select position $\Omega \rightarrow \text{Capacitor Symbol}$
2. Press the **MODE** key until the symbol “nF” is displayed.
3. Insert the red cable into input terminal $\text{Hz}\%V \rightarrow \Omega \rightarrow \text{Capacitor Symbol}$ and the black cable into input terminal **COM**.
4. Long press the **REL** key before carrying out measurements.
5. Position the leads at the ends of the capacitor to be tested, respecting, if necessary, the positive (red cable) and negative (black cable) polarity (see Fig. 8). The display shows the value of capacitance. **Depending on the value of capacitance to be measured, the instrument could take approx. 20s before displaying the final value**
6. The message “OL.” indicates that the value of capacitance exceeds the maximum measurable value.
7. To use the HOLD and REL functions, see § 4.2.

5.8. TEMPERATURE MEASUREMENT WITH K-TYPE PROBE



CAUTION

Before attempting any temperature measurement, cut off power supply from the circuit to be measured and make sure that all capacitors are discharged, if present.

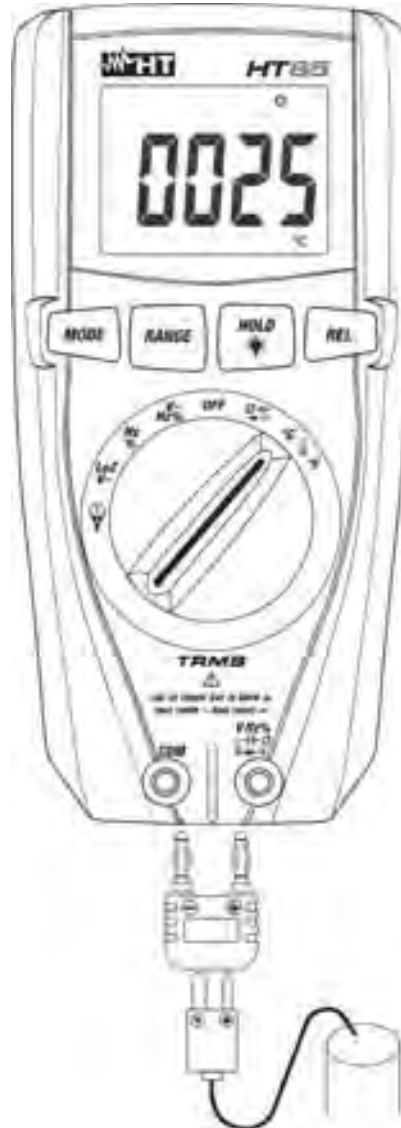

Fig. 9: Use of the instrument for Temperature measurement

1. Select position °C or position °F
2. Insert the provided adapter into input terminals $\left(\text{Hz} \% \text{V} \rightarrow \text{H} \Omega \rightarrow \text{H} \cdot \right)$ (polarity +) and **COM** (polarity -) (see Fig. 9)
3. Connect the provided K-type wire probe or the optional K-type thermocouple (see § 7.3.2) to the instrument by means of the adapter, respecting the positive and negative polarity on it. The display shows the value of temperature
4. The message “OL.” indicates that the value of temperature exceeds the maximum measurable value.
5. To use the HOLD function, see § 4.2.

5.9. DC CURRENT MEASUREMENT WITH TRANSDUCER CLAMPS

CAUTION



- Maximum current measurement in this function is 1000A. Do not measure currents exceeding the limits given in this manual
- The instrument performs the measurement by using **standard** clamp transducers of HT family. For transducer clamps with Hypertac output connector is necessary the NOCANBA optional adapter in order to perform the connection

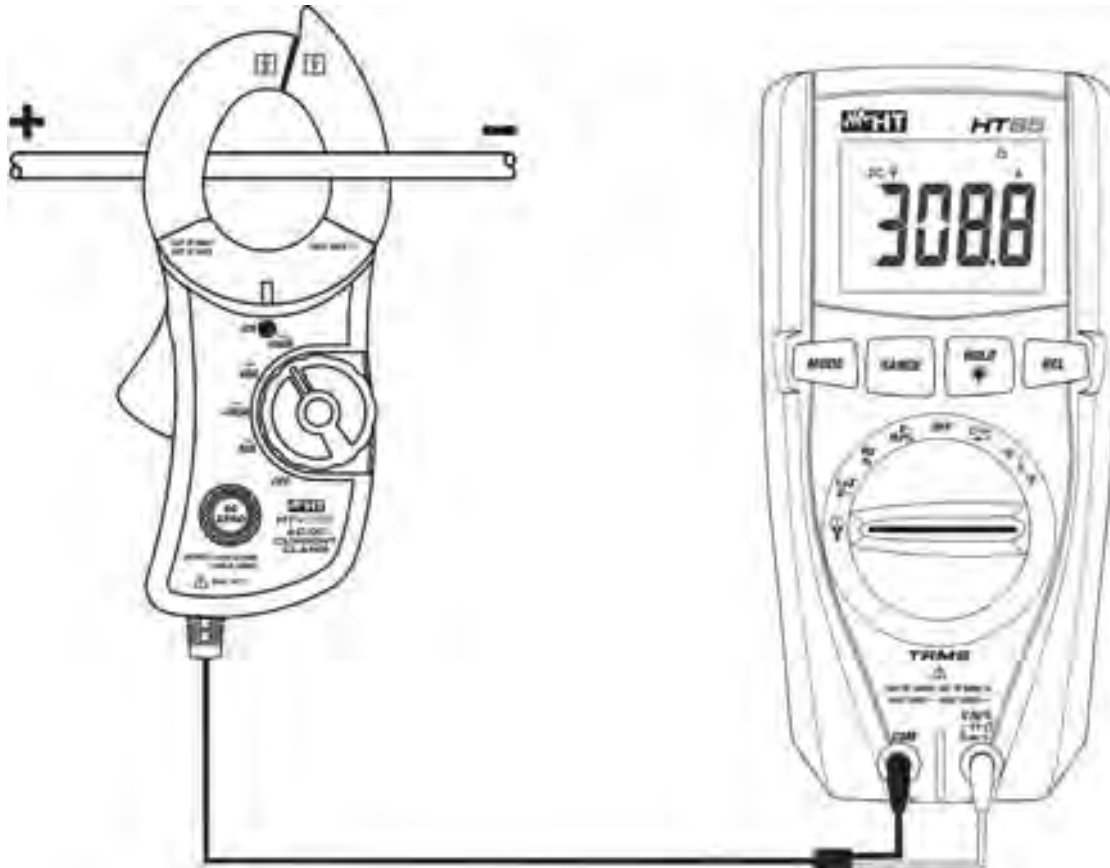

Fig. 10: Use of the instrument for DC current measurement with transducer clamps

1. Select position
2. Press **MODE** key to select “DC” measurement
3. Press **RANGE** key to select on the instrument the **same range** set on the transducer clamp among the options: **10A, 40A (only HT4006), 100A, 400A (only HT4006), 1000A**. The selected range appear for 2s on the display
4. Insert the red cable into input terminal and the black cable into input terminal **COM**. For other standard transducers (see § 7.3.2) with Hypertac connector use the NOCANBA optional accessory. For information about the use of transducer clamps refer to relative user manual
5. Insert the cable inside the jaw (see Fig. 10). The value of current appears on the display
6. If the display shows the message “**OL**”, the maximum measurable value has been reached
7. When symbol “-” appears on the instrument’s display, it means that current has the opposite direction with respect to the connection in Fig. 10
8. To use the HOLD, RANGE and REL functions, see § 4.2

5.10. AC CURRENT MEASUREMENT WITH TRANSDUCER CLAMPS

CAUTION



- Maximum current measurement in this function is 3000A. Do not measure currents exceeding the limits given in this manual
- The instrument performs the measurement by using both flexible transducer clamp (optional accessory F3000U) and other **standard** clamp transducers of HT family. For transducer clamps with Hypertac output connector is necessary the NOCANBA optional adapter in order to perform the connection

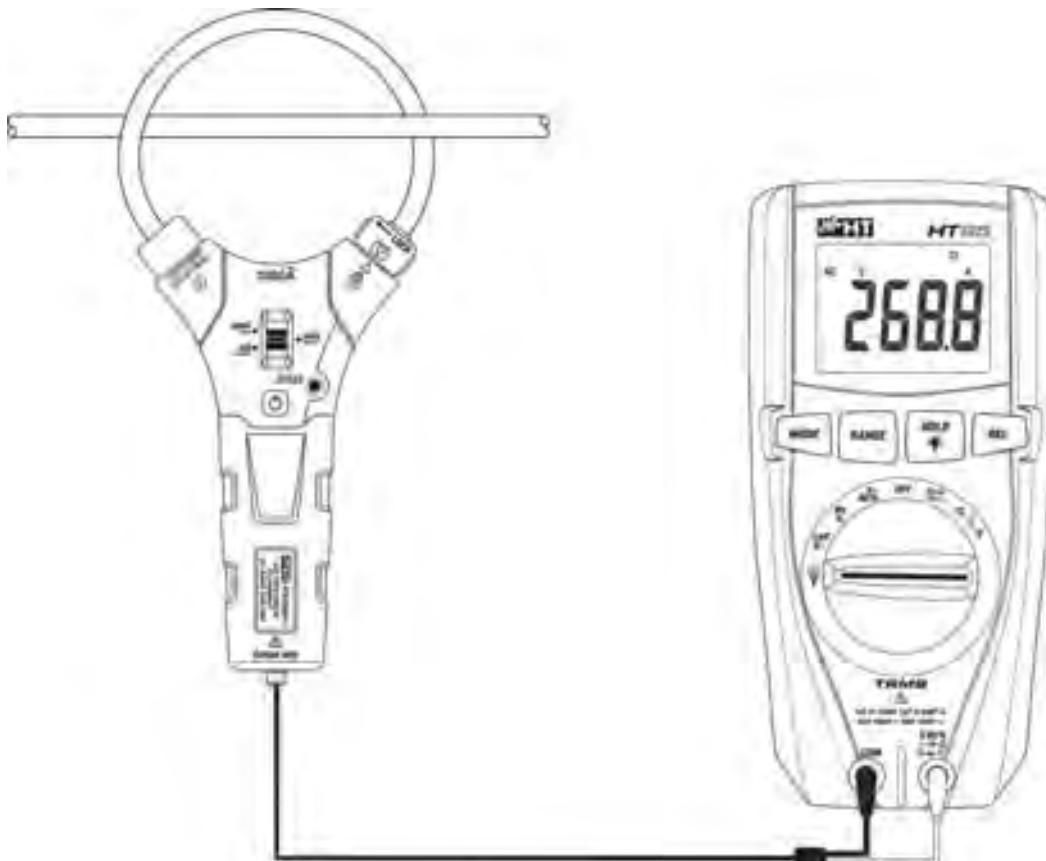

Fig. 11: Use of the instrument for AC current measurement with transducer clamps

1. Select position
2. Press **RANGE** key to select on the instrument the **same range** set on the transducer clamp among the options: **1000mA, 10A, 30A, 40A (only HT4006), 100A, 300A, 400A (only HT4006), 1000A, 3000A**. The selected range appear for 2s on the display
3. Insert the red cable into input terminal and the black cable into input terminal **COM**. For other standard transducers (see § 7.3.2) with Hypertac connector use the NOCANBA optional accessory. For information about the use of transducer clamps refer to relative user manual
4. Insert the cable inside the jaw (see Fig. 32). The value of current appears on the display
5. Press and hold the **MODE** key to select measurements “Hz” o “%” in order to display the values of frequency and duty cycle of input current. Press and hold again the **MODE** key to go back to current measurement
6. If the display shows the message “OL”, the maximum measurable value has been reached
7. To use the HOLD, RANGE and REL functions, see § 4.2

6. MAINTENANCE





CAUTION



- Only expert and trained technicians should perform maintenance operations. Before carrying out maintenance operations, disconnect all cables from the input terminals.
- Do not use the instrument in environments with high humidity levels or high temperatures. Do not expose to direct sunlight.
- Always switch off the instrument after use. In case the instrument is not to be used for a long time, remove the battery to avoid liquid leaks that could damage the instrument's internal circuits.

6.1. REPLACING BATTERY

When the LCD display shows the symbol , it is necessary to replace the battery.

1. Position the rotary switch to **OFF** and remove the cables from the input terminals.
2. Turn the fastening screw of the battery compartment cover from position  to position  and remove it.
3. Remove the battery and insert a new battery of the same type (see § 7.1.2), respecting the indicated polarity.
4. Restore the battery compartment cover into place and turn the fastening screw from position  to position .
5. Do not scatter old batteries into the environment. Use the relevant containers for disposal.

6.2. CLEANING THE INSTRUMENT

Use a soft and dry cloth to clean the instrument. Never use wet cloths, solvents, water, etc.

6.3. END OF LIFE



WARNING: the symbol on the instrument indicates that the appliance and its accessories must be collected separately and correctly disposed of.

7. TECHNICAL SPECIFICATIONS

7.1. TECHNICAL CHARACTERISTICS

Accuracy calculated as [%reading + (num. digits*resolution)] at 18°C ÷ 28°C <75%RH

DC Voltage

Range (*)	Resolution	Accuracy	Input impedance	Overload protection
400.0mV	0.1mV	±(1.2%rdg + 4dgt)	10MΩ	1500VDC
4.000V	0.001V			
40.00V	0.01V			
400.0V	0.1V			
1500V	1V	±(1.5%rdg + 2dgt)		

AC TRMS Voltage

Range	Resolution	Accuracy (*) (50Hz÷1kHz)	Input impedance	Overload protection
4.000V	0.001V	±(1.2%rdg + 10dgt)	10MΩ	1000VDC/ACrms
40.00V	0.01V	±(1.5%rdg + 3dgt)		
400.0V	0.1V			
1000V	1V	±(2.0%rdg + 4dgt)		

(*) Accuracy specified from 5% to 100% of the measuring range; Frequency range: 50Hz ÷ 1kHz (sinusoidal waveform)
For not sinusoidal waveforms the accuracy is: ±(10.0%rdg + 10dgt) (50Hz÷60Hz)

DC/AC TRMS Voltage with low impedance (LoZ)

Range	Resolution	Accuracy (*)	Input impedance	Overload protection
4.000V	0.001V	±(3.0%rdg+40dgt)	approx 3kΩ	600VDC/ACrms
40.00V	0.01V			
400.0V	0.1V			
600V	1V			

(*) Accuracy specified from 5% to 100% of the measuring range; Frequency range: 50Hz ÷ 1kHz (sinusoidal waveform)
For not sinusoidal waveforms the accuracy is: ±(10.0%rdg + 10dgt) (50Hz÷60Hz)

Diode test

Function	Resolution	Accuracy	Max voltage with open circuit	Overload protection
	1mV	±(10%rdg+5dgt)	<3VDC	250VDC/ACrms

DC Current with transducer clamp

Range	Output ratio	Resolution	Accuracy (*)	Overload protection
10A	100mV/1A	0.01A	±(1.5%rdg + 6dgt)	1000VDC/ACrms
40A (**)	10mV/1A		±(1.5%rdg + 26dgt) (***)	
100A		1mV/1A	0.1A	
400A (**)	±(1.5%rdg + 26dgt) (***)			
1000A	1A		±(1.5%rdg + 6dgt)	

(*) Accuracy referred to only instrument without transducer clamp; (**) With HT4006 transducer; (***) Accuracy instrument + clamp

AC TRMS Current with transducer clamp

Range	Output ratio	Resolution	Accuracy (*) (50Hz÷1kHz)	Overload protection
1000mA	1V/1A	1mA	±(2.5%rdg + 10dgt)	1000VDC/ACrms
10A	100mV/1A	0.01A		
30A			10mV/1A	
40A (**)	1mV/1A	1A		
100A			±(3.5%rdg + 30dgt) (***)	
300A	±(2.5%rdg + 10dgt)			
400A (**)		±(3.5%rdg + 30dgt) (***)		
1000A	±(2.5%rdg + 10dgt)			
3000A				

(*) Accuracy referred to only instrument without transducer clamp; Accuracy specified from 5% to 100% of the measuring range

(**) With HT4006 transducer; (***) Accuracy instrument + clamp

For not sinusoidal waveforms the accuracy is: ±(10.0%rdg + 10dgt)

Resistance and Continuity test

Range (*)	Resolution	Accuracy	Buzzer	Overload protection
400.0Ω	0.1Ω	±(1.2%rdg + 4dgt)	<50Ω	250VDC/ACrms
4.000kΩ	0.001kΩ	±(1.0%rdg + 2dgt)		
40.00kΩ	0.01kΩ	±(1.2%rdg + 2dgt)		
400.0kΩ	0.1kΩ			
4.000MΩ	0.001MΩ	±(2.0%rdg + 3dgt)		
40.00MΩ	0.01MΩ			

Frequency (electrical circuits)

Range (*)	Resolution	Accuracy	Overload protection
10Hz ÷ 10kHz	0.001Hz÷0.01kHz	±(1.5%rdg + 5dgt)	600VDC/ACrms

Frequency (electronic circuits)

Range	Resolution	Accuracy	Overload protection
9.999Hz	0.001Hz	±(1.5%rdg + 5dgt)	250VDC/ACrms
99.99Hz	0.01Hz		
999.9Hz	0.1Hz	±(1.2%rdg + 3dgt)	
9.999kHz	0.001kHz		
99.99kHz	0.01kHz		
999.9kHz	0.1kHz		
9.999MHz	0.001MHz	±(1.5%rdg + 4dgt)	
10.00MHz	0.01MHz		

Sensitivity: >8Vrms

In AC voltage frequency range: 10Hz ÷10kHz, sensitivity >15Vrms

Duty Cycle

Range (*)	Resolution	Accuracy
0.5% ÷ 99%	0.1%	±(1.2%rdg + 2dgt)

Pulse frequency range: 5Hz ÷ 10kHz, Pulse duration: 100μs ÷ 100ms

In AC voltage frequency range: 10Hz ÷10kHz, sensitivity >15Vrms

Capacitance (Autorange)

Range	Resolution	Accuracy	Overload protection
40.00nF	0.01nF	$\pm(5.0\%rdg + 7dgt)$	250VDC/ACrms
400.0nF	0.1nF	$\pm(3.0\%rdg + 5dgt)$	
4.000 μ F	0.001 μ F		
40.00 μ F	0.01 μ F		
400.0 μ F	0.1 μ F	$\pm(5.0\%rdg + 5dgt)$	
4.000mF	0.001mF	$\pm(10\%rdg)$	
40.00mF	0.01mF		

Temperature with K-type probe (Autorange)

Range	Resolution	Accuracy (*)	Overload protection
-20°C ÷ 760°C	1°C	$\pm(3.0\%rdg + 5^{\circ}C)$	250VDC/ACrms
-4°F ÷ 1400°F	1°F	$\pm(3.0\%rdg + 9^{\circ}F)$	

(*) Instrument accuracy with no probe

7.1.1. Reference standards

Safety:	IEC/EN61010-1
EMC:	IEC/EN 61326-1
Insulation:	double insulation
Pollution level:	2
Overvoltage category:	CAT IV 600V, CAT III 1000V to ground

7.1.2. General characteristics
Mechanical characteristics

Size (L x W x H):	175 x 85 x 55mm (7 x 3 x 2in)
Weight (batteries included):	360g (13 ounces)
Mechanical protection:	IP40

Power supply

Battery type:	1x9V battery type IEC 6F22
Low battery indication:	symbol  on the display
Battery life:	ca.45h (backlight ON), ca 60h (backlight OFF)
Auto Power Off:	after 15 minutes' idling (can be disabled)

Display

Conversion:	TRMS
Characteristics:	4 LCD, 4000 dots, decimal sign, point and backlight
Sampling frequency:	3 times/s

7.2. ENVIRONMENT

7.2.1. Environmental conditions for use

Reference temperature:	18°C ÷ 28°C (64°F ÷ 82°F)
Operating temperature:	0°C ÷ 40°C (32°F ÷ 104°F)
Allowable relative humidity:	<70%RH
Storage temperature:	-20°C ÷ 60°C (-4°F ÷ 140°F)
Storage humidity:	<80%RH
Max operating altitude:	2000m (6562ft)

This instrument satisfies the requirements of Low Voltage Directive 2014/35/EU (LVD) and of EMC Directive 2014/30/EU

This instrument satisfies the requirements of European Directive 2011/65/EU (RoHS) and 2012/19/EU (WEEE)

7.3. ACCESSORIES

7.3.1. Accessories provided

- Pair of test leads
- Adapter + K-type wire probe
- Batteries
- ISO9000 calibration certificate
- Carrying bag
- User manual

7.3.2. Optional accessories

- | | |
|--|--------------|
| • K-type probe for air and gas temperature | Code TK107 |
| • K-type probe for semisolid substance temperature | Code TK108 |
| • K-type probe for liquid substance temperature | Code TK109 |
| • K-type probe for surface temperature | Code TK110 |
| • K-type probe for surface temperature with 90° tip | Code TK111 |
| • Flexible transducer clamp AC 30/300/3000A | Cod. F3000U |
| • Standard transducer clamp AC 1-100-1000A/1V | Cod. HT96U |
| • Standard transducer clamp AC 10-100-1000A/1V | Cod. HT97U |
| • Standard transducer clamp DC 1000A/1V | Cod. HT98U |
| • Standard transducer clamp AC/DC 40/400A | Cod. HT4006 |
| • Adapter for connection of standard clamp with Hypertac connector | Cod. NOCANBA |

8. ASSISTANCE

8.1. WARRANTY CONDITIONS

This instrument is warranted against any material or manufacturing defect, in compliance with the general sales conditions. During the warranty period, defective parts may be replaced. However, the manufacturer reserves the right to repair or replace the product. Should the instrument be returned to the After-sales Service or to a Dealer, transport will be at the Customer's charge. However, shipment will be agreed in advance. A report will always be enclosed to a shipment, stating the reasons for the product's return. Only use original packaging for shipment. Any damage due to the use of non-original packaging material will be charged to the Customer. The manufacturer declines any responsibility for injury to people or damage to property.

The warranty shall not apply in the following cases:

- Repair and/or replacement of accessories and battery (not covered by warranty).
- Repairs that may become necessary as a consequence of an incorrect use of the instrument or due to its use together with non-compatible appliances.
- Repairs that may become necessary as a consequence of improper packaging.
- Repairs which may become necessary as a consequence of interventions performed by unauthorized personnel.
- Modifications to the instrument performed without the manufacturer's explicit authorization.
- Use not provided for in the instrument's specifications or in the instruction manual.

The content of this manual cannot be reproduced in any form without the manufacturer's authorization.

Our products are patented and our trademarks are registered. The manufacturer reserves the right to make changes in the specifications and prices if this is due to improvements in technology.

8.2. ASSISTANCE

If the instrument does not operate properly, before contacting the After-sales Service, please check the conditions of battery and cables and replace them, if necessary. Should the instrument still operate improperly, check that the product is operated according to the instructions given in this manual. Should the instrument be returned to the After-sales Service or to a Dealer, transport will be at the Customer's charge. However, shipment will be agreed in advance. A report will always be enclosed to a shipment, stating the reasons for the product's return. Only use original packaging for shipment; any damage due to the use of non-original packaging material will be charged to the Customer.