



# ENGLISH

## User manual



**Table of contents**

1. PRECAUTIONS AND SAFETY MEASURES .....	2
1.1. Preliminary instructions .....	2
1.2. During use.....	3
1.3. After use.....	3
2. GENERAL DESCRIPTION .....	4
3. PREPARATION FOR USE .....	4
3.1. Initial checks .....	4
3.2. Instrument power supply .....	4
3.3. Storage.....	4
4. NOMENCLATURE.....	5
4.1. Instrument description.....	5
4.2. Description of the displayed symbols.....	5
4.3. Description of function keys .....	6
4.3.1. Trigger key T .....	6
4.3.2.  / ▲ key .....	6
4.3.3.  / ▼ key .....	6
4.3.4. MODE key .....	6
5. OPERATING INSTRUCTIONS.....	7
5.1. IR temperature measurement .....	7
5.2. K-type temperature measurement .....	8
6. MAINTENANCE.....	9
6.1. General information.....	9
6.2. Battery replacement .....	9
6.3. Cleaning the instrument .....	9
6.4. End of life .....	9
7. TECHNICAL SPECIFICATIONS.....	10
7.1. Reference guidelines .....	10
7.2. General characteristics .....	10
7.3. Environmental conditions for use.....	11
7.4. Accessories provided.....	11
8. SERVICE .....	12
8.1. Warranty conditions .....	12
8.2. Assistance.....	12

## 1. PRECAUTIONS AND SAFETY MEASURES

The instrument has been designed in compliance with the directives relevant to electronic measuring instruments. For your safety and in order to prevent damaging the instrument, please carefully follow the procedures described in this manual and read all notes preceded by the symbol  with the utmost attention. The following symbol is used in this manual:



### CAUTION

When this symbol is displayed, the instrument is able to emit a laser pointer. **Always prevent the laser from radiating your eyes, in order to avoid any injury.** Class 2 laser device according to EN 60825-1.

### 1.1. PRELIMINARY INSTRUCTIONS



### CAUTION



- Use the instrument only as specified in this user manual. Improper use may damage the instrument.
- During use and storage, keep the instrument away from direct sunlight or sources of light, hot surfaces or objects, high temperatures, high humidity or particularly critical environmental conditions.
- After a period of storage under extreme environmental conditions, **let the instrument resume normal operating conditions before using it.**
- Moving the thermometer quickly from a cold to a warm place it may condense on the focal lens from which infrared radiation is captured. Wait until condensation is absorbed before taking measurements.
- Do not touch the internal focal lens.
- Make sure that the target is larger than the unit's spot size. The smaller the target, the closer you should be to it. When accuracy is critical, make sure the target is at least twice as large as the spot size.
- Do not carry out measurements under conditions exceeding the limits specified in § 7.
- Make sure that battery is correctly installed.
- Do not carry out any measurement if you notice anomalous conditions such as breakages, leakages of battery liquid, blind display, etc.
- This instrument is not recommended for use in measuring shiny or polished surfaces (stainless steel, aluminum, etc.).
- The instrument cannot measure IR temperature through transparent surfaces such as glass. The instrument will measure the surface temperature of the glass instead.
- Steam, dust, smoke, etc. can prevent accurate IR measurements.

## 1.2. DURING USE

Please carefully read the following recommendations and instructions:



### CAUTION

- Never press the trigger **T** when symbol  is displayed and the instrument is directed towards the eyes. The instrument emits a laser pointer.
- If the target has a smooth surface reflecting the laser, prevent the laser from beaming your eyes.
- If symbol  is displayed during use, interrupt testing and replace the batteries according to the procedure described in § 6.2
- Be extremely careful when the laser pointer is turned on.
- Do not direct the instrument, especially the laser beam, towards people or animals.
- When using the laser pointer, be careful no to direct the beam onto a reflective surface which could reflect the beam into your eyes.
- Never radiate the laser if flammable gas is present.

## 1.3. AFTER USE

If the instrument is not to be used for a long time, remove the batteries

## 2. GENERAL DESCRIPTION

The instrument has the following features:

- Infrared temperature measurement up to 1000°C (1832°F)
- Temperature measurement with type-K probe
- Laser pointer area for an immediate localization of distance/spot
- Automatic reading lock (HOLD)
- Auto Power OFF
- Distance / Spot ratio D:S = 20:1
- Measures in °C/°F
- LCD with backlight
- Detection of MAX, MIN, AVG and DIF values
- High and Low alarm threshold setting
- IP54 mechanical protection

## 3. PREPARATION FOR USE

### 3.1. INITIAL CHECKS

Before shipping, the instrument has been checked from an electric as well as mechanical point of view. However, we suggest you to check it rapidly, to detect possible damage which may have occurred during transport. In case you find out anomalies, immediately contact the Dealer. We also recommend checking that the packaging contains all components indicated in § 7.4. In case the instrument should be returned, please follow the instructions given in § 8.1.

### 3.2. INSTRUMENT POWER SUPPLY

The instrument is supplied with 2x1.5V alkaline batteries type AAA LR03, included in the package. When batteries are nearly flat, the symbol "⊕" is displayed. To replace the batteries, see § 6.2

### 3.3. STORAGE

In order to guarantee precise measurements, after a long storage time under extreme environmental conditions, wait until the instrument comes back to normal conditions (see § 7.3).

## 4. NOMENCLATURE

### 4.1. INSTRUMENT DESCRIPTION

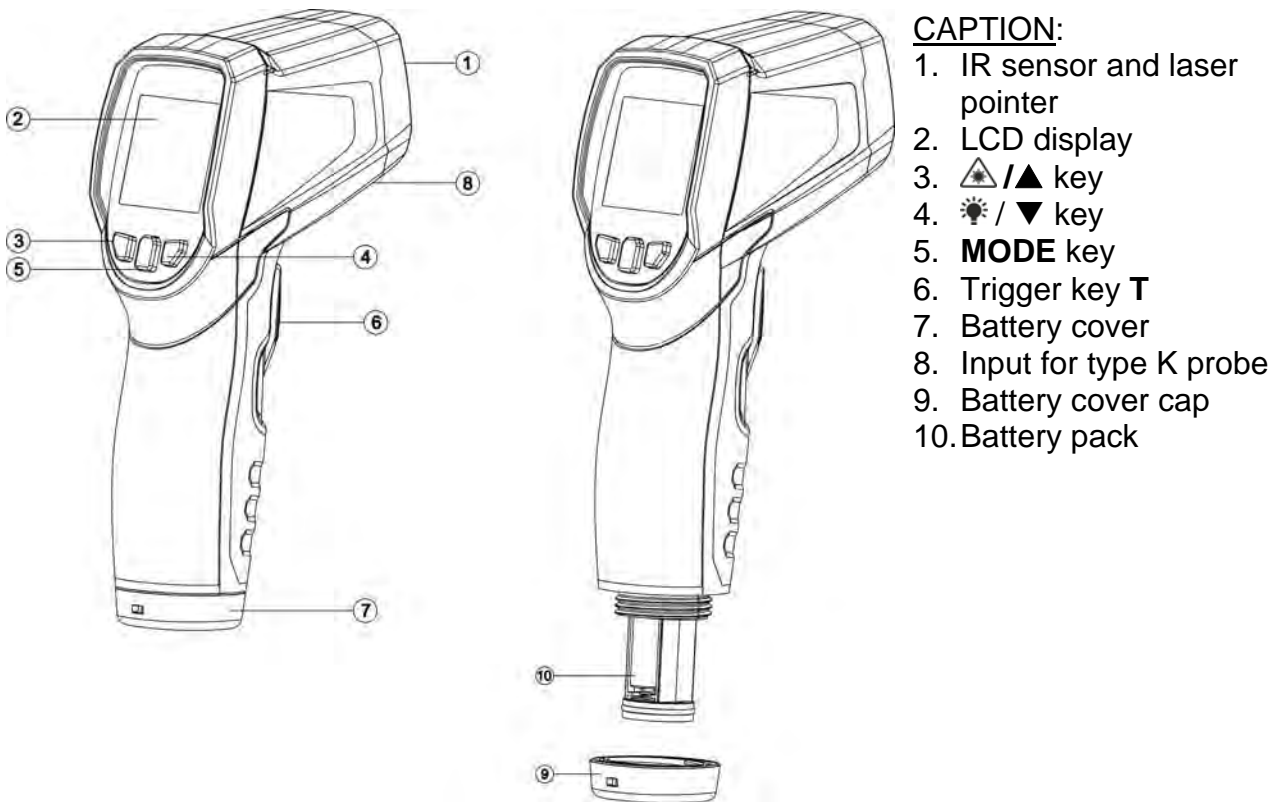

Fig. 1: Description of the instrument's parts

### 4.2. DESCRIPTION OF THE DISPLAYED SYMBOLS

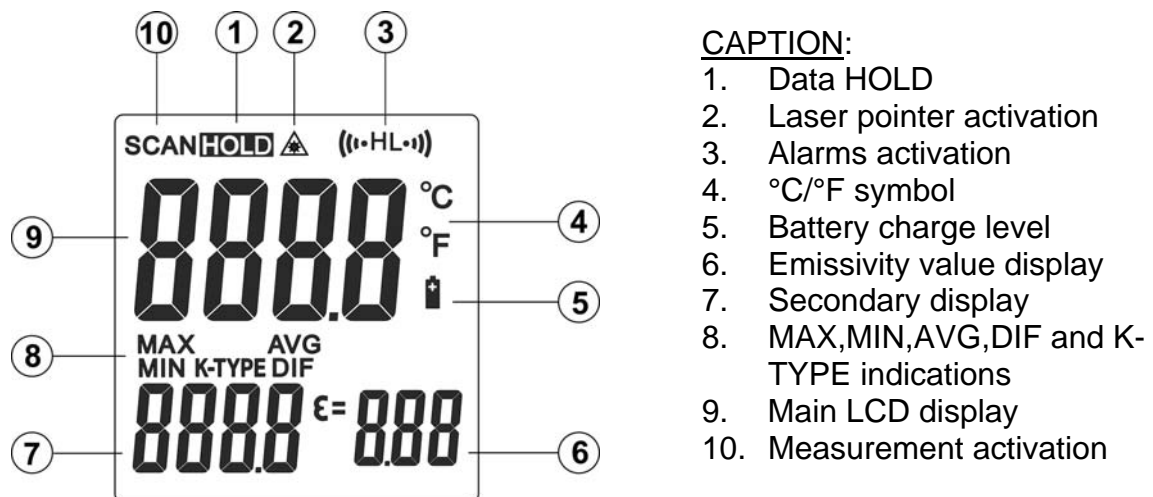

Fig. 2: LCD display description



### 4.3. DESCRIPTION OF FUNCTION KEYS

#### 4.3.1. Trigger key T



The Trigger key **T** (see Fig. 1 – part 6) allows the following operations:

- Switching on the instrument and activating measurement by continuously pressing (“SCAN” symbol on display)
- Automatic switching of the HOLD mode (data fixed on display) when releasing after measurement

#### 4.3.2. / key



The  /  key allows the activation/deactivation of the double laser pointer by pressing trigger key **T**. The “” symbol (see Fig. 2 – part 2) is displayed. The same key allows to performs the selection of parameters inside setup section (see § 4.3.4)

#### 4.3.3. / key

The  /  key allows the activation/deactivation of the display backlight. The same key allows to performs the selection of parameters inside setup section (see § 4.3.4)

#### 4.3.4. MODE key

Press the **MODE** key to select the Maximum (“MAX” symbol), Minimum (“MIN” symbol), Average (“AVG” symbol) and Difference between Max and Min (“DIF” symbol) values in the secondary display (see Fig. 2 - part 7) in the IR temperature measurement by pressing trigger **T** key.

The long press (> 2s) of the **MODE** key allows to enter in the setup section of the instrument. The cyclic pressure of the **MODE** key allows to pass passage from one parameter to another as shown in the following Fig. 3. Use the arrow keys  or  to set the value with parameter flashing at display

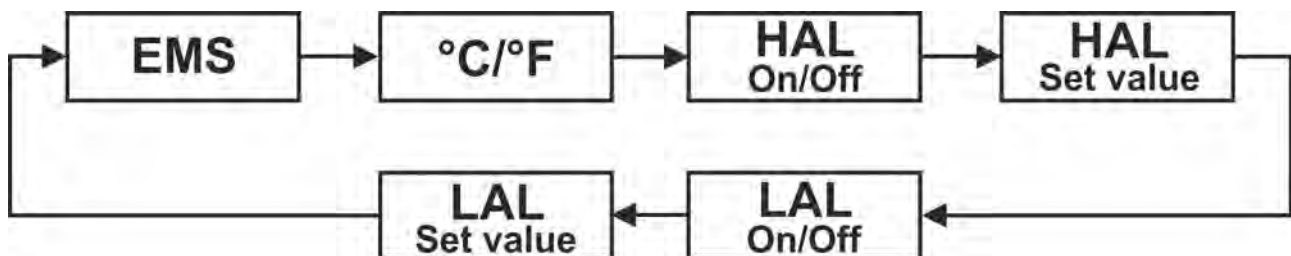



Fig. 3: Setup parameters description

The followed parameters are set:

- **EMS** → Setting emissivity value of the material in the range: **0.01 ÷ 1.00**
- **°C/°F** → Setting unit of temperature between the options: “°C” (Celsius) or “°F” (Fahrenheit)
- **HAL (On/Off)** → Activation/deactivation “High” alarm in the IR temperature measurement. The “” symbol is flashing at display
- **HAL (Set value)** → Setting “High” alarm threshold in the range: **-50° ÷ 1000°C (-58°F ÷ 1832°F)**. For values > HAL threshold the instrument emits a continue sound
- **LAL (On/Off)** → Activation/deactivation “Low” alarm in the IR temperature measurement. The “” symbol is flashing at display
- **LAL (Set value)** → Setting “Low” alarm threshold in the range: **-50° ÷ 1000°C (-58°F ÷ 1832°F)**. For values < LAL threshold the instrument emits a continue sound

Press **MENU** key to save and back to the measurement screen

## 5. OPERATING INSTRUCTIONS

### 5.1. IR TEMPERATURE MEASUREMENT

1. Switch on the instrument by pressing trigger key **T**
2. Press  $\blacktriangle$  /  $\blacktriangle$  key to activate/deactivate the double laser pointer (see § 4.3.2)
3. Press **MODE** key to set the unit, activate/deactivate the alarm thresholds and the correct Emissivity value depending on the material (see § 4.3.4)
4. Press and hold Trigger key **T** to activate the test and point the instrument in the direction of the target 's surface



#### CAUTION

The area laser beam allows an immediate evaluation of the maximum size of the measuring spot with regard to the distance from the target in order to get a correct temperature measurement.

5. Make sure that the target, whose temperature is to be measured, is at least as large as the unit's spot (see Fig. 4). The smaller the object is, the closer you should be to it (Example: if the distance from the object is 240mm – 9.4inch, the section of the object should be at least of 12mm – 0.5inch for a correct temperature measurement). **When accuracy is critical, make sure the object is at least twice as large as the spot size**

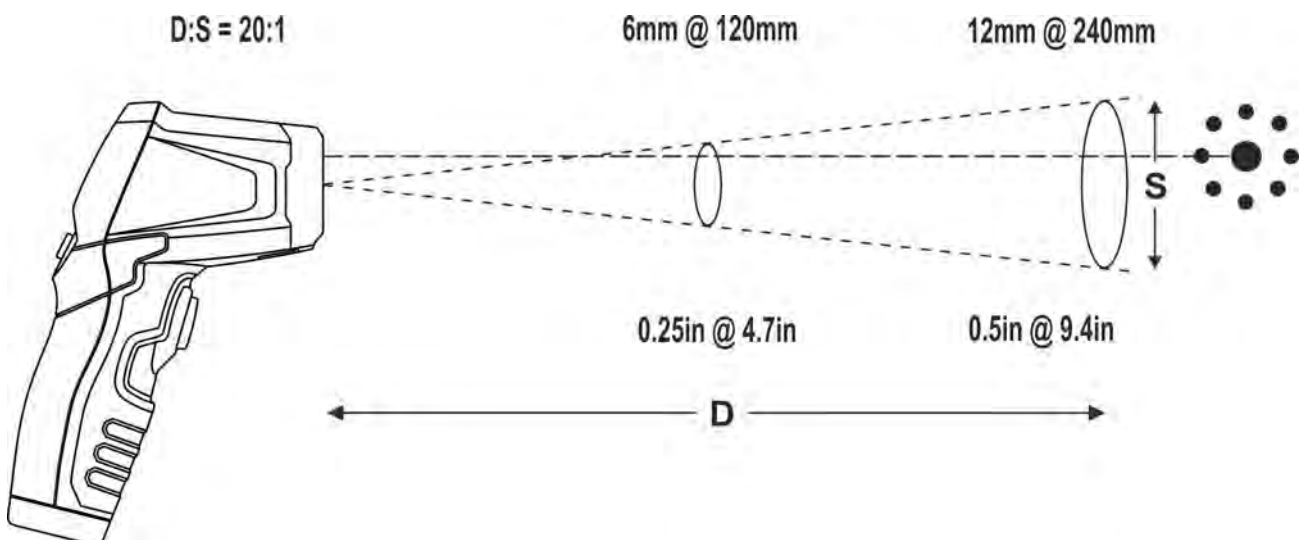

Fig. 4: Distance / Spot ratio of the instrument

6. Release Trigger key **T** to stop measuring and freeze the last read value on the main display. The message "HOLD" is shown. The MAX, MIN, AVG or DIF values is also shown on the secondary display by pressing **MODE** key
7. The instrument will automatically switch off after 10 seconds of idleness.



## 5.2. K-TYPE TEMPERATURE MEASUREMENT

### CAUTION



- Do not compare the infrared temperature measurement with the measurements made with K-type probe, since (because of the totally different nature of the two methods) the obtained values may differ remarkably
- Measurement with the K-type probe can be used in situations where IR measurement cannot be used (e.g.: measurement of shiny/bright surfaces such as glass and plexiglas)

1. Open the protection cap of K-type input terminal (see Fig. 1 – part 8) and connect the K-type probe respecting the indicated polarities (see Fig. 5)

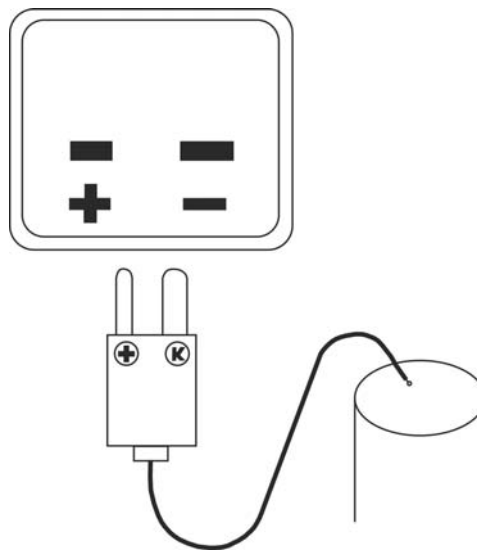

Fig. 5: Connection of K-type probe in the instrument

2. Switch on the instrument by pressing trigger key **T** and verify the “K-TYPE” message in the top part of the secondary display
3. Connect the probe to the device under test
4. Press and hold Trigger key **T** to activate the test
5. Release Trigger key **T** to stop measuring and freeze the last read value on the secondary display. The message “HOLD” is shown
6. The instrument will automatically switch off after 10 seconds of idleness

## 6. MAINTENANCE

### 6.1. GENERAL INFORMATION

1. While using and storing the instrument, carefully observe the recommendations listed in this manual in order to prevent possible damage or danger during use.
2. Do not use the instrument in environments with high humidity levels or high temperatures. Do not expose to direct sunlight.
3. Always switch off the instrument after use. In case the instrument is not to be used for a long time, remove the battery to avoid liquid leaks that could damage the instrument's internal circuits.

### 6.2. BATTERY REPLACEMENT

When the display shows the symbol "⊕" replace the battery.



#### CAUTION

Only expert and trained technicians should perform this operation. Before removing batteries, disconnect all cables from input terminals.

1. Unscrew the battery cover cap (see Fig. 1 – part 9) and extract the battery pack (see Fig. 1 – part 10)
2. Remove the flat batteries, insert new battery of the same type (see § 7.2) by respecting the indicated polarities (see Fig. 6), restore the battery pack and screw the battery cover cap

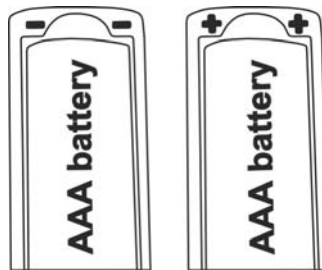

Fig. 6: Replace internal batteries

3. Do not scatter old battery into the environment. Use the relevant containers for disposal.

### 6.3. CLEANING THE INSTRUMENT

Use a soft and dry cloth to clean the instrument. Never use wet cloths, solvents, water, etc.

### 6.4. END OF LIFE



**CAUTION:** the symbol indicates that the appliance, the battery and its accessories must be collected separately and correctly disposed of.

## 7. TECHNICAL SPECIFICATIONS

Accuracy indicated as  $[\pm(\% \text{reading}) \text{ or } \pm \text{degrees}]$  in the interval:  $23^{\circ}\text{C} \div 25^{\circ}\text{C}$  ( $73^{\circ}\text{F} \div 77^{\circ}\text{F}$ )

### INFRARED TEMPERATURE MEASUREMENT

Function	Range	Resolution	Accuracy	Response time
°C	-50°C ÷ 20°C	0.1°C	±3.5°C	<150ms
	20°C ÷ 300°C		±(1%rdg + 1°C)	
	300°C ÷ 1000°C		±(1.5%rdg)	
°F	-58°F ÷ 68°F	0.1°F	±6.3°F	
	68°F ÷ 572°F		±(1%rdg + 1.8°F)	
	572°F ÷ 1000°F		±(1.5%rdg)	
	1000°F ÷ 1832°F	1°F		

Reading repeatability:  $-50^{\circ}\text{C} \div 20^{\circ}\text{C}$  ( $-31^{\circ}\text{F} \div 68^{\circ}\text{F}$ ) →  $\pm 1.8^{\circ}\text{C}$  ( $\pm 3.2^{\circ}\text{F}$ )  
 $20^{\circ}\text{C} \div 1000^{\circ}\text{C}$  ( $68^{\circ}\text{F} \div 1832^{\circ}\text{F}$ ) →  $\pm 0.5\% \text{rdg}$  or  $\pm 0.5^{\circ}\text{C}$  ( $\pm 0.9^{\circ}\text{F}$ )

Spectrum response:  $8 \div 14\mu\text{m}$   
 D/S ratio: 20:1  
 IR sensor: thermopile  
 Allows emissivity: selectable in the range:  $0.01 \div 1.00$   
 Laser: pointer ( $<1\text{mW}$ , Class 2 compliance with IEC/EN60825-1)  
 Over range indication: "----" symbol at display

### K-TYPE TEMPERATURE MEASUREMENT

Function	Range	Resolution	Accuracy (*)	Response time
°C	-50°C ÷ 1000°C	0.1°C	±2.0°C	<150ms
	1000°C ÷ 1370°C	1°C	(-50°C ÷ 0°C) ±(0.5%rdg + 1.5°C) (0°C ÷ 1000°C)	
°F	-58°F ÷ 1000°F	0.1°F	±3.6°F	
	1000°F ÷ 2498°F	1°C	(-58°F ÷ 32°F) ±(0.5%rdg + 3°F) (32°F ÷ 2498°F)	

(\*) Accuracy of only instrument without probe

#### 7.1. REFERENCE GUIDELINES

EMC: IEC/EN61326-1  
 Laser source: IEC/EN60825-1, Class 2  
 Max operating altitude: 2000m (6592ft)

#### 7.2. GENERAL CHARACTERISTICS

##### Mechanical specifications

Size (L x W x H): 180 x 105 x 55mm (7 x 4 x 2in)  
 Weight (batteries included): 240g (8ounces)  
 Mechanical protection: IP54  
 Drop test: 2m

##### Power supply

Battery type: 2x1.5V alkaline batteries type AAA LR03  
 Low battery indication: symbol "⊕" appears on display  
 Auto Power OFF: after 10 seconds' idleness

##### Display

Characteristics: 4 LCD, Custom, backlit

### 7.3. ENVIRONMENTAL CONDITIONS FOR USE

Operating temperature:	0°C ÷ 50°C (32°F ÷ 122°F)
Operating humidity:	10%RH ÷ 90%RH
Storage temperature:	-10°C ÷ 60°C (14°F ÷ 140°F)
Storage humidity:	<80%RH

**This instrument complies with Directive EMC 2014/30/EU  
This instrument complies with European Directive 2011/65/EU (RoHS)  
and 2012/19/EU (WEEE)**

### 7.4. ACCESSORIES PROVIDED

- Soft transport bag
- K-type bead probe
- Batteries
- User manual

## 8. SERVICE

### 8.1. WARRANTY CONDITIONS

This instrument is warranted against any material or manufacturing defect, in compliance with the general sales conditions. During the warranty period, defective parts may be replaced. However, the manufacturer reserves the right to repair or replace the product. Should the instrument be returned to the After-sales Service or to a Dealer, transport will be at the Customer's charge. However, shipment will be agreed in advance. Only use original packaging for shipment; any damage due to the use of non-original packaging material will be charged to the Customer. The manufacturer declines any responsibility for injury to people or damage to property.

The warranty shall not apply in the following cases:

- Repairs that may become necessary as a consequence of an incorrect use of the instrument or due to its use together with non-compatible appliances.
- Repairs that may become necessary as a consequence of improper packaging.
- Repairs which may become necessary as a consequence of interventions performed by unauthorized personnel.
- Modifications to the instrument performed without the manufacturer's explicit authorization.
- Use not provided for in the instrument's specifications or in the instruction manual.

The content of this manual cannot be reproduced in any form without the manufacturer's authorization.

**Our products are patented and our trademarks are registered. The manufacturer reserves the right to make changes in the specifications and prices if intended to improve technology.**

### 8.2. ASSISTANCE

If the instrument does not operate properly, before contacting the After-sales Service, please check the conditions of the battery and replace it, if necessary. Should the instrument still operate improperly, check that the product is operated according to the instructions given in this manual. Should the instrument be returned to the After-sales Service or to a Dealer, transport will be at the Customer's charge. However, shipment will be agreed in advance. **A report will always be enclosed to a shipment, stating the reasons for the product's return.** Only use original packaging for shipment; any damage due to the use of non-original packaging material will be charged to the Customer.