

METRAHIT IM XTRA BT (M273B/D/S) & METRAHIT IM E-DRIVE BT (M274/B/S/I) & METRAHIT IM TECH BT (M272B/S) Insulation Tester, Milliohmmeter, TRMS Multimeter, Inter-Turn Short Circuit Tester

3-447-035-03
9/1.24



Scope of Delivery (depending on instrument variant)

- 1 Multimeter with rubber holster
- 1 HC40 hard case
(for multimeter and accessories)
(Z270K black, Z270H orange or Z270O green)
- 1 Quick-change, rechargeable lithium polymer battery (Z270A or Z270G)
- 1 USB Power Pack (5 V DC, 2 A) or USB PD Power Pack (270U)
- 1 Micro USB Cable
- 1 Probe with keys (with start/stop and store/send function) (Z270S) (METRAHIT IM XTRA BT and METRAHIT IM E-DRIVE only)
- 1 KS17-2 cable set (1 pair of safety measurement cables, red/black, with 4 mm test tips) (GTY362003P0002)
- 1 Pair of KC4 Kelvin clips (Z227A)
(METRAHIT IM XTRA BT and METRAHIT IM TECH BT only)
- 1 KC&S Kelvin clip and Kelvin probe (Z227C)
(METRAHIT IM E-DRIVE BT only)
- 1 DAkkS calibration certificate
- 1 Condensed operating instructions
* Comprehensive operating instructions available on the Internet for download from www.gossenmetrawatt.com
- 1 IZYTRONIQ Business Starter license (card with registration key for software)



Overview, Scope of Delivery

Accessories	Type	Article No.	Article Number Set			
			M273S	M274S	M274I	M272S
METRAHIT IM XTRA BT		M273D	X			
METRAHIT IM E-DRIVE BT		M274B		X	X	
METRAHIT IM TECH BT		M272B				X
Quick-change, rechargeable lithium polymer battery	M27x	Z270A/Z270G	X	X	X	X
USB charger (5 V DC, 2 A) including micro USB cable	M27x		X	X	—	X
USB PD charger		270U	0	0	X	0
Micro USB cable		270V	0	0	X	0
Mains supply module with USB port	M27x	Z270E	0	0	0	0
Probe with keys	Z270S	Z270S	X	X	X	—
Cable set	KS17-2	GTY362003P0002	X	X	X	X
1 pair of Kelvin clips	KC4	Z227A	X	0	0	X
1 pair of Kelvin probes	KC27	Z227B	0	0	0	0
1 Kelvin clip & 1 Kelvin probe	KC&S	Z227C	0	X	X	0
Concentric Kelvin probes for 4-wire measurement	KCC	Z2270	0	0	0	0
Cable reel for 4-wire measurement, 100 meters	KCV100	Z227E	0	0	0	0
Hard case						
Black		Z270K	X			X
Orange		Z270H		X	X	
Green	HC40	Z270O	0	0	0	0
Magnetic holder and Velcro fastener	HIT-Clip	Z117A	0	0	0	0
COIL adapter, 10 µH ... 50 mH	COIL TEST ADAPTER	Z270F	0	0	0	—
COIL adapter, 10 µH ... 5 H	COIL ADAPTER XTRA	Z270M	0	0	0	—
Set of test probes with alligator clips for COIL adapter XTRA	KSC-3L	Z110C	0	0	0	—
Adapter cable, 4 mm plug to 6 mm socket	AK-4M/6F	Z110L	0	0	0	0
Adapter cable, 4 mm plug to 8 mm socket	AK-4M/8F	Z110M	0	0	0	0
Functions expansion to 16 test sequences with up to 63 test steps each	Sequence functions Expert	Z270P	0	0	0	0
Functions expansion METRAHIT IM GRAPH	METRAHIT IM GRAPH	Z270T	0	0	0	0
IZYTRONIQ Business Starter license	S101S & Z956A	S101S & Z956A	X	X	X	X

Key

X = standard

0 = option

— = not possible, not intended

Overview of Included Features

Function	METRAHIT IM XTRA BT E-DRIVE BT	METRAHIT IM TECH BT
V _{DC} (R _i = 9 MΩ)	•	•
V _{AC} / Hz TRMS (R _i = 9 MΩ)	$\overline{1\text{kHz}}$ filter	$\overline{1\text{kHz}}$ filter
V _{AC+DC} TRMS (R _i = 9 MΩ) ¹	$\overline{1\text{kHz}}$ filter	$\overline{1\text{kHz}}$ filter
V _{AC+DC} TRMS (R _i = 1 MΩ) R _{ISO} range (interference voltage)	•	
Hz (V _{AC})	... 300 kHz	... 300 kHz
V _{AC} , AC+DC bandwidth	100 kHz	100 kHz
A _{DC} , AC, AC+DC / Hz TRMS	10 nA ... 1 A	10 nA ... 1 A
Fuse F1, current measuring function	1 A/1000 V - 30 kA ⁴	1 A/1000 V - 30 kA ⁴
Current sensor transformation ratio \Rightarrow	1 mV : 1 • 10 • 100 • 1000 mA	1 mV : 1 • 10 • 100 • 1000 mA
Hz (A AC)	... 30 kHz	... 30 kHz
Insulation resistance RISO: Test Voltages	50 • 100 • 250 • 500 • 1000 V	
Inter-turn short circuit test (1 kV) with COIL adapter	Option	
Duty cycle measurement as %	•	
RPM measurement	•	
Resistance R _{lo} with 200 mA per EN 61557	•	
Milliohm with 4-wire method, mΩ with 200 mA	•	•
Milliohm with 4-wire method, mΩ with 1 A pulse	•	•
Fuse F2, R _{lo} measuring function	315 mA/1000 V – 30 kA ⁴	
Resistance Ω	•	•
Continuity \square)	•	•
Diode ... 4.5 V \rightarrow	•	•
Temperature: °C/°F TC type K and Pt100/1000 ²	•	•
Capacitance \dashv	•	•
Min-Max / data hold	•	•
Test sequence	1 (with 10 steps)	
METRAHIT IM GRAPH	Option	Option
Expert sequence functions	Option	Option
64 MBit memory ³	•	•
Bluetooth® interface Frequency band: 2.402 ... 2.480 GHz Transmission intensity: +1.5 dBm Transmitting power: max. 91 mW	•	•
3.5" TFT color graphic display	•	•
Probe with start/stop and send/store keys	•	
Quick-change battery with USB charging	•	•
Mains supply module with USB port	Option	Option
Protection	IP 52	IP 52
Measuring category	1000 V CAT III, 600 V CAT IV	1000 V CAT III, 600 V CAT IV

¹ Due to system design, the DC component displayed in the smallest measuring range (300 mV) has an offset. Select the VDC function for precise measurement of the DC component.

² With optional temperature sensors

³ For 300,000 measured values, sampling rate adjustable from 0.1 seconds to 9 hours

⁴ 30 kA = minimum breaking capacity

Accessories (sensors, plug inserts, adapters, consumable materials)

The accessories available for your instrument are checked for compliance with currently valid safety regulations at regular intervals, and are amended as required for new applications. Currently up-to-date accessories which are suitable for your measuring instrument are listed on our website along with photo, order number, description and, depending upon the scope of the respective accessory, data sheet and operating instructions:

www.gossenmetrawatt.de

Contents	Page	Contents	Page
1	6	7.7	22
Safety Instructions		7.7.1	22
2	7	7.7.2	22
Applications		7.7.3	24
2.1	7	7.8	25
Intended Use / Use for Intended Purpose		Speichervisualisierung (nur mit Funktionserweiterung METRAHIT IM GRAPH)	
2.2	7	7.8.1	25
Use for Other than Intended Purpose		Datenanzeige bei Messreihen.....	
2.3	7	8	27
Liability and Guarantee		Measurements	
2.4	7	8.1	27
Opening the Instrument / Repairs		Enabling Parameter Changes	
2.5	7	8.2	27
Manufacturer's Guarantee		Insulation Resistance Measurement – RISO Function (METRAHIT IM XTRA BT and METRAHIT IM E-DRIVE BT only)	
3	7	8.2.1	27
Documentation		8.2.2	28
3.1	7	8.2.3	29
Product Variants		8.3	29
3.2	7	Inter-Turn Short Circuit Measurement – COIL Function (METRAHIT IM XTRA BT and METRAHIT IM E-DRIVE only)	
3.3	7	8.3.1	29
Symbols		8.3.2	31
4	8	8.4	35
Operating Overview		Absorption Index Measurement – DAR (METRAHIT IM XTRA BT and METRAHIT IM E-DRIVE BT only)	
4.1	8	8.5	36
Connections, Keys, Rotary Switch, Symbols (depending on instrument variant)		Polarization Index Measurement – PI (METRAHIT IM XTRA BT and METRAHIT IM E-DRIVE BT only)	
4.2	9	8.6	37
Symbols Used in the Digital Display		Voltage Measurement	
4.3	10	8.6.1	37
Rotary Switch Position Symbols (depending on instrument variant)		8.6.2	39
4.4	10	8.6.3	39
Used Symbols		8.6.4	40
5	11	8.7	41
Initial Startup		Resistance Measurement “Ω”	
5.1	11	8.8	42
Battery Pack		Capacitance Measurement F	
5.2	12	8.9	43
Mains Module with USB Port		Temperature Measurement with Resistance Thermometers – Temp RTD	
5.3	13	8.10	44
Switching the Instrument On		Temperature Measurement with Thermocouple – Temp TC	
6	14	8.11	45
System Settings		Continuity Test	
6.1	14	8.12	45
Digital Keyboard		Diode Testing with Constant Current of 1 mA	
6.2	14	8.13	46
Firmware		Milliohm Measurement – Rlo (2-wire measurement) (METRAHIT IM XTRA BT and METRAHIT IM E-DRIVE only)	
6.3	15	8.14	47
Language Selection		8.14.1	47
6.4	15	8.14.2	48
Time and Date Settings		8.14.3	49
6.5	15	8.14.4	49
Digital Display Settings		8.15	50
6.5.1	15	8.15.1	50
Brightness		8.15.2	51
6.5.2	15	8.15.3	52
Display Profile		8.15.4	53
6.6	15	8.16	54
Set Display of Leading Zeros		Measuring Sequences – Test Sequences	
6.7	15	8.17	56
Configuring Password Protection		Funktionserweiterung Graph	
6.7.1	15	9	57
Selecting or Changing a Password		Interface Operation and Software	
6.7.2	16	9.1	57
Deactivating Password Protection		Bluetooth®	
6.8	16	9.2	57
Viewing the Instrument's Name		USB/WIFI	
6.9	16	9.3	58
Installing a Functions Expansion		Software for Receiving and Evaluating Data	
6.10	17	9.3.1	58
Switching the Instrument Off		9.3.2	58
6.10.1	17	9.3.3	59
Switching the Instrument Off Manually		9.3.4	59
6.10.2	17		
Automatic Shutdown (auto-off)			
6.11	17		
Default Settings (instrument reset)			
7	18		
Control Functions			
7.1	18		
Help			
7.2	19		
Selecting Measuring Functions and Measuring Ranges			
7.2.1	19		
Automatic Range Selection			
7.2.2	19		
Manual Range Selection			
7.2.3	19		
Quick Measurements			
7.3	19		
Zero Offset / Relative Measurements			
7.4	20		
Display (TFT)			
7.4.1	20		
Digital Display			
7.4.2	20		
Analog Display			
7.5	20		
Measured Value Storage – Data Function (Auto-hold/Compare)			
7.5.1	21		
Saving Minimum and Maximum Values – “MinMax”			
7.6	21		
Measured Value Memory – STORE Function			
7.6.1	21		
Remote read-out and storage via the Z270S probe (METRAHIT IM XTRA BT and METRAHIT IM E-DRIVE BT only)			
7.6.2	22		
Remote Read-Out and Storage via the PC – PUSH/PRINT Function			

10	Characteristic Values.....	62
11	Maintenance and Calibration.....	66
11.1	Displays – Error Messages	66
11.2	Fuses	66
11.3	Housing Maintenance	66
11.4	Measurement Cables.....	66
11.5	Recalibration.....	66
12	Accessories	67
12.1	General	67
12.2	Technical Data for Measurement Cables (included with KS17-2 cable set and Z270S probe)	67
13	Returns and Environmentally Sound Disposal.....	67
14	CE Declaration	68
15	Addresses.....	69
15.1	Product Support.....	69
15.2	Recalibration Service.....	69
15.3	Repair and Replacement Parts Service Calibration Center * and Rental Instrument Service	69

1 Safety Instructions

Observe this documentation, in particular all included safety information, in order to protect yourself and others from injury, and to prevent damage to the instrument.

- Carefully and completely read and adhere to these operating instructions, as well as the instrument's condensed operating instructions. The respective documents can be found at <http://www.gossenmetrawatt.com>. Retain these documents for future reference.
- Tests/measurements with this instrument may only be performed in the commercial trades by a qualified electrician, or under the supervision and direction of a qualified electrician. The user must be instructed by a qualified electrician concerning performance and evaluation of the tests/measurements.
- The multimeter may only be operated by persons who are capable of recognizing touch hazards and taking the appropriate safety precautions. Touch hazards in accordance with the standard prevail anywhere, where dangerous voltages may occur. Avoid working alone when taking measurements which involve touch hazards. Be certain that a second person is present.
- Observe and comply with all safety regulations which are applicable for your work environment.
- Wear suitable and appropriate personal protective equipment (PPE) whenever working with the instrument.
- Use only the specified accessories (included in the scope of delivery or listed as options) with the instrument.
- Carefully and completely read and adhere to the product documentation for optional accessories. Retain these documents for future reference.
- Use the instrument in undamaged condition only.
- Inspect the instrument before use. Pay particular attention to damage, interrupted insulation or kinked cables.
- Damaged components must be replaced immediately.
- Accessories and cables may only be used as long as they're fully intact.
- Inspect accessories and all cables and before use. Pay particular attention to damage, interrupted insulation or kinked cables.
- If the instrument or its accessories don't function flawlessly, permanently remove the instrument/accessories from operation and secure them against inadvertent use.
- If the instrument or accessories are damaged during use, for example if they're dropped, permanently remove the instrument/accessories from operation and secure them against inadvertent use.
- If there are any signs of interior damage to the instrument or accessories (e.g. loose parts in the housing), permanently remove the instrument/accessories from operation and secure them against inadvertent use.
- Do not use the instrument and its accessories after long periods of storage under unfavorable conditions (e.g. humidity, dust or extreme temperature).
- Do not use the instrument and its accessories after extraordinary stressing due to transport.
- Only use the instrument and its accessories within the limits of the specified technical data and conditions (ambient conditions, IP protection code, measuring category etc.).
- Do not use the instrument in potentially explosive atmospheres.
- The instrument must not be exposed to direct sunlight.
- The instrument and the accessories may only be used for the tests/measurements described in the documentation for the instrument.
- Maximum permissible voltage between the voltage measuring sockets or all connector sockets and ground is 1000 V for measuring category III and 600 V for measuring category IV.
- The multimeter may only be operated with installed rechargeable battery pack or mains module. Dangerous current and

voltage are otherwise not indicated! The instrument may also be damaged.

- Weak (undercharged) battery: Do not perform any safety-relevant measurements if the "battery low" symbol appears in the battery display. Moreover, compliance with the specified data is no longer assured when the battery is weak.
- Be prepared for the occurrence of unexpected voltages at devices under test (e.g. defective devices). For example, capacitors may be dangerously charged.
- Do not perform any measurements in electrical circuits with corona discharge (high-voltage).
- Dangerous pulsating voltages in HF electrical circuits! Use caution when performing measurements there.
- Do not use the instrument if the fuse cover has been removed. Touch contact with dangerous voltage is otherwise possible.
- The instrument is equipped with fuses. The instrument may only be used as long as the fuses are in flawless condition. Defective fuses must be replaced.
- Plugging in the measurement cables must not necessitate any undue force.
- Never touch conductive ends (e.g. of test probes).
- Fully unroll all measurement cables before starting a test/measurement. Never perform a test/measurement with the measurement cable rolled up.
- Ensure that alligator clips, test probes or Kelvin probes make good contact.
- The instrument is equipped with a Bluetooth® module. Determine whether or not use of the implemented frequency band of 2.402 to 2.480 GHz is permissible in your country.
- Always create a backup copy of your measurement data.

Battery Pack

The instrument is powered by a rechargeable battery pack.

Observe the following points for this reason:

- Carefully and completely read and comply with the "supplementary safety information sheet" for the Z270A or Z270G battery pack (3-349-997-15 or 3-447-030-51). The manufacturer's safety data sheet is included with the supplementary sheet. Read and comply with this supplementary sheet as well.
- The battery pack may not be exposed to direct sunlight (whether it's inside or outside of the instrument).
- Only charge the battery pack within a temperature range of 10 to 45 °C.
- Only store the battery pack within a temperature range of -20 to 50 °C.
- Only operate the battery pack within a temperature range of -10 to 50 °C.
- Risk in case of full depletion: In some cases it's no longer possible to recharge a fully depleted battery pack (immediate failure), in which case it must be replaced. Full depletion may also result in a shortened service life. In order to prevent full depletion, charge the battery pack at the mains at least once a year, but preferably at more frequent, regular intervals.
- Transporting the battery pack: Observe the "supplementary safety information sheet" for the Z270A or Z270G battery pack (3-349-997-15 or 3-447-030-51)!

Mains Module

As an alternative to the battery pack, the instrument can be supplied with power via the optional USB mains module. Observe the following points:

- The USB mains module may not be exposed to direct sunlight (whether it's inside or outside of the instrument).
- Only operate the USB mains module within a temperature range of -10 to 50 °C.
- In the event of a thunderstorm, disconnect the USB mains module from the mains outlet.

2 Applications

Please read this important information!

2.1 Intended Use / Use for Intended Purpose

The METRAHIT IM XTRA BT is multimeter, milliohmeter, insulation measuring instrument, coil tester and data logger in one. The METRAHIT IM E-DRIVE BT is a multimeter, milliohmeter, insulation measuring instrument, coil tester and data logger for hybrid and electric drives. The METRAHIT IM TECH BT is multimeter, milliohmeter and data logger in one.

All three are portable instruments which can be held in the hand while performing measurements. They can be used to perform the measurements described in these operating instructions and in the short-form operating instructions.

Performance characteristics of the individual models: see "Overview of Included Features" on page 3

The multimeter is equipped with an automatic socket blocking mechanism for your safety, and in order to safeguard your instrument. This mechanism is linked to the rotary switch and only allows access to those jacks which are actually required for the selected function. It also prevents the user from turning the rotary switch to impermissible functions after the measurement cables have already been plugged in.

Safety of the operator, as well as that of the instrument, is only assured when it's used for its intended purpose.

Safety of the operator, as well as that of the instrument, is only assured when it's used for its intended purpose.

2.2 Use for Other than Intended Purpose

Using the instrument for any purposes other than those described in the condensed operating instructions or these instrument operating instructions is contrary to use for intended purpose.

2.3 Liability and Guarantee

Gossen Metrawatt GmbH assumes no liability for property damage, personal injury or consequential damage resulting from improper or incorrect use of the product, in particular due to failure to observe the product documentation. Furthermore, all guarantee claims are rendered null and void in such cases.

Nor does Gossen Metrawatt GmbH accept any liability for data loss.

2.4 Opening the Instrument / Repairs

The instrument may only be opened by authorized, trained personnel in order to ensure flawless, safe operation and to assure that the guarantee isn't rendered null and void. Even original replacement parts may only be installed by authorized, trained personnel.

When the instrument is opened, voltage conducting parts may be exposed. The instrument must be disconnected from the measuring circuit before performing repairs or replacing parts. If repair of a live, open instrument is required, it may only be carried out by trained personnel who are familiar with the dangers involved.

Unauthorized modification of the instrument is prohibited.

If it can be ascertained that the instrument has been opened by unauthorized personnel, no guarantee claims can be honored by the manufacturer with regard to personal safety, measuring accuracy, compliance with applicable safety measures or any consequential damages.

If a guarantee seal is included and it has been damaged or removed, all guarantee claims are rendered null and void.

2.5 Manufacturer's Guarantee

The guarantee period for all METRAHIT digital multimeters and calibration instruments is 3 years after date of shipment. The manufacturer's guarantee covers materials and workmanship. Damages resulting from use for any other than the intended pur-

pose or operating errors, as well as any and all consequential damages, are excluded.

The calibration certificate confirms that the product's specified technical data were complied with at the point in time of calibration. We guarantee compliance with the specified technical data within the permissible tolerances for a period of 12 months after delivery.

The guarantee can be extended to 5 years by registering free of charge on the myGMC portal.

<https://www.gmc-instruments.de/services/mygmc/>

3 Documentation

3.1 Product Variants

This documentation describes several instrument variants. Functions may be described which are not included in your instrument. Observe respective variant identification.

Illustrations may differ from your instrument.

3.2 Firmware Version

These operating instructions describe an instrument based on firmware version 1.007.000.

Complete information concerning your instrument's firmware version and updating can be found in section 6.2.

3.3 Symbols

The following symbols with the meanings listed below are used in this documentation.

Danger Symbols



Warning concerning a point of danger (attention, observe documentation!)



Warning concerning dangerous voltage at the measurement input: $U > 15 \text{ V AC}$ or $U > 25 \text{ V DC}$

Acoustic Warnings



High-voltage warning: $> 1000 \text{ V}$ (intermittent acoustic signal)



Very high amperage warning: $> 1 \text{ A}$ (continuous acoustic signal)

User Interface Symbols in the Following Sections



Scroll through main menu



Scroll through submenu



Select decimal point, increase/decrease measuring range



Increase/decrease value (test voltage for insulation resistance measurement or threshold for continuity test)

4 Operating Overview

4.1 Connections, Keys, Rotary Switch, Symbols (depending on instrument variant)

METRAHIT IM XTRA BT and METRAHIT IM E-DRIVE BT



METRAHIT IM TECH BT



- 1 Charge level LED (see section 5.1)
- 2 Display (TFT), see section 4.2 for meanings of symbols
- 3 Softkeys (menu-dependent keys for selecting switching functions and parameters, and for starting/ending measurements)
- 4 **STORE**: Save key or push/print function for **IZYTRONIQ**
- 5 **OK**: Key for acknowledgment and for restarting the instrument from the standby mode by pressing and holding
- 6 **Rotary switch** for measuring functions (see page 9 for meanings of symbols)
- 7 DAkKS calibration seal
- 8 Connector sockets for current measurement with automatic blocking
 ⊥: ground input
 A: current measurement input
- 9 **S+/S-**: sense terminals for 4-wire measurements (mΩ /4)
- 10 Extended connection for Z270S probe
 (operating instructions 3-349-996-15) (not METRAHIT IM TECH BT)
- 11 Connector sockets for voltage measurement with automatic blocking
 ⊥: ground input
 V, Ω, Temp, **⚡**, **⚡**,
 COIL measurement input (not METRAHIT IM TECH BT)
- 12 **ESC**: *Operating mode menu:*
Press key briefly: Exit the menu level – jump back to a higher level, exit parameters entry without saving
Press and hold: The instrument is switched to the standby mode. Switch back on by pressing and holding the **OK** key.
- 13 **MENU**: Key for accessing the five main menus.
- 14 **Scroll keys:**
 △ Increase parameter values
Operating mode menu: Selection of individual menu items
 ▽ Decrease values
Operating mode menu: Selection of individual menu items
 ▷ Increase measuring range or move decimal point to the right (**Man** function)
 ◁ Decrease measuring range or move decimal point to the left (**Man** function)
- 15 Brightness sensor

4.2 Symbols Used in the Digital Display

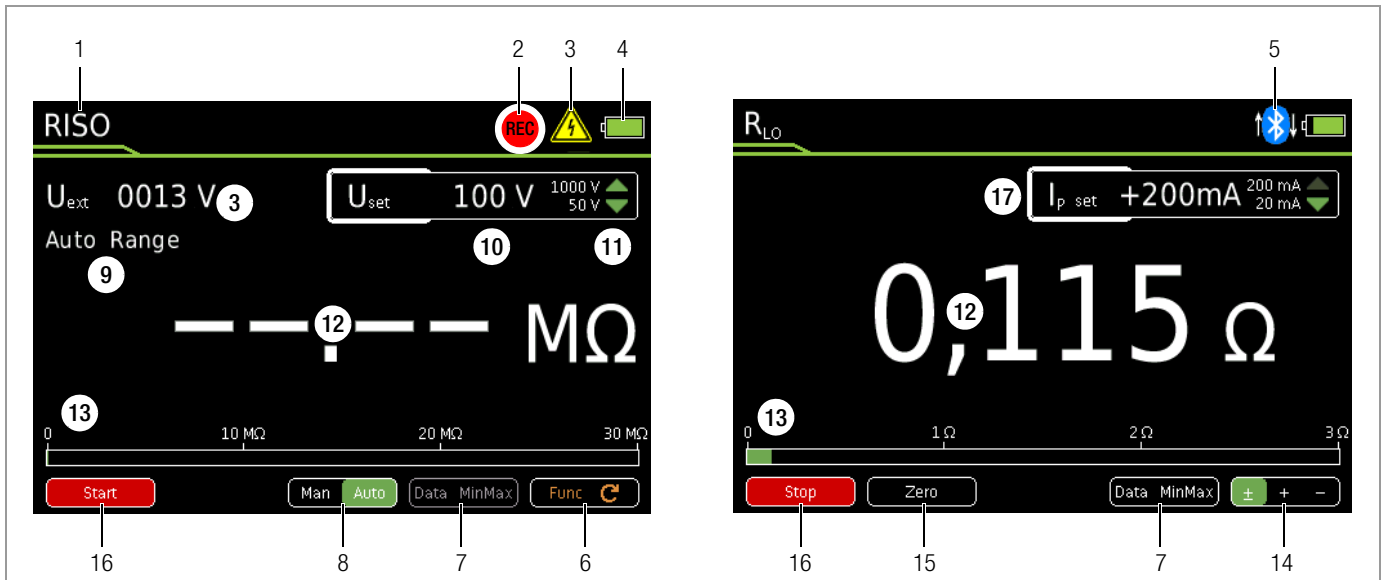

- 1 Momentary measuring function
- 2 Memory symbol
- 3 Important, in this case: U_{ext} (interference voltage) or **warning regarding dangerous voltage: $U > 15 \text{ V AC}$ or $U > 25 \text{ V DC}$**
- 4 Battery pack charge level (see page 11)
Optionally when using the USB mains module:
 - The multimeter is supplied via a charger without communication.
 - The multimeter is connected to a device with communication (USB socket to PC).
- 5 Bluetooth® activity indicator
- 6 **Func**: switch back and forth amongst the functions of a given rotary switch position
- 7 **Data MinMax**: switch amongst “Data” (freeze measured value), “Min-Max storage” and deactivate both functions
- 8 **Man Auto**: switch back and forth between manual and automatic measuring range selection
- 9 Display of the selected measuring range with manual measuring range selection:
 - Select a smaller measuring range
 - Select a larger measuring range
- 10 Selected test voltage
- 11 Select test voltage:
 - Select a larger test voltage
 - Select a smaller test voltage
- 12 Digital display with decimal point and polarity display
Measuring range exceeded: **OL** is displayed
- 13 Scale for analog display
- 14 Polarity selection
- 15 **Zero**: activate/deactivate zero balancing
- 16 **Start/Stop**: For measurements which are not started automatically
- 17 **Ip**: test current

4.3 Rotary Switch Position Symbols (depending on instrument variant)

Switches	FUN C	Display	Measuring Function	Additional Current Clamp Sensor Function ⇒ Clip = 1:1/10/100/1000 (via the "Setup for present measurement" menu)
RISO ¹	0/4	RISO MΩ	Insulation resistance measurement	
		U _{ext}	Pulsating voltage, TRMS DC + AC, 15 Hz ... 500 Hz, only for detection of interference voltage! (before starting measurement)	
		Uset	Selectable test voltage: 50, 100, 250, 500 or 1000 V	
		UI50	Applied/measured test voltage during measurement	
Coil ¹	1	Coil U-V, U-W, V-W [μs]	Inter-turn short circuit test with optional coil adapter (COIL TEST ADAPTER or COIL ADAPTER XTRA)	
Coil ¹	2	DAR [kΩ/s]	Dielectric absorption rate	
Coil ¹	3	PI [kΩ/s]	Polarization index	
V~	0/5	VAC	Alternating voltage, AC TRMS, full bandwidth	✗ AC clamp (V): Current clamp sensor
Hz	1	Hz	Voltage frequency, full bandwidth	✗ Hz clamp (V): Current clamp sensor
Hz	2	Duty AC % ¹	Duty cycle measurement	
Hz	3	RPM AC ¹	RPM measurement	
V~	4	V AC Fil	Alternating voltage, AC TRMS, with low-pass filter (1 kHz)	
V=	0/3	VDC ²	Direct voltage	✗ DC clamp (V): Current clamp sensor
V≈	1	V (AC+DC) ²	Mixed voltage, TRMS $V_{ACDC} = \sqrt{(V_{AC}^2 + V_{DC}^2)}$	✗ AC + DC clamp (V): Current clamp sensor
V≈	2	V (AC+DC) Fil ²	Mixed voltage, TRMS AC DC, with low-pass filter (1 kHz)	
Ω	0/4	Ω	(DC) resistance	
— —	1	F— —, nF, μF	Capacitance	
Temp RTD	2	°C Pt 100/1000	Temperature with Pt 100 / Pt 1000 resistance thermometer	
Temp TC	3	°C, type K	Temperature, type K thermocouple	
□)	0/2	□) Ω	Continuity test with acoustic signal	
—▶—	1	—▶— V	Diode voltage where I is constant	
Rlo ¹	0	Rlo/2L Ω	2-wire milliohm measurement where I _P = ±/+/- 200 mA	
mΩ/4	0	Rlo/4W Ω	4-wire milliohm measurement where I _P = 200 mA or 1 A	
A=	0/4	A DC	Direct current amperage	
A≈	1	A (AC+DC)	Mixed current amperage, AC DC TRMS	
A≈	2	AAC	Alternating current amperage, AC TRMS	
A≈	3	Hz	Current frequency	

¹ METRAHIT IM XTRA BT and METRAHIT IM E-DRIVE BT only

² Clip = off

4.4 Used Symbols



Warning concerning a point of danger (attention, observe documentation!)



Ground

CAT III / IV

Measuring category III or IV device



Continuous, doubled or reinforced insulation



Indicates European Conformity



Fuse, see section 11.2



This device, its electronic accessories, batteries and rechargeable batteries may not be disposed of with the trash. Further information regarding the WEEE mark can be accessed on the Internet at www.gossenmetrawatt.com under the search term WEEE (see also section 13).

Calibration seal (blue seal):

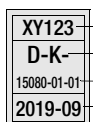

— Consecutive number

— D-K — Deutsche Akkreditierungsstelle GmbH – calibration lab

— 15080-01-01 — Registration number

— 2019-09 — Date of calibration (year – month)

See also "Recalibration" on page 66

5 Initial Startup

The instrument must first be supplied with power. The instrument is powered by the rechargeable battery pack included in the scope of delivery. Alternatively, it can be supplied with power via the optionally available USB mains module (see “Accessories (sensors, plug inserts, adapters, consumable materials)” on page 3).

The rechargeable battery pack, as well as the USB mains module, is equipped with a patented, contact-protected module socket, which makes replacement possible without interrupting the measuring circuit.

5.1 Battery Pack

A quick-change, rechargeable lithium polymer battery (Z270A/Z270G) with matching USB power pack, as well as a USB cable (micro USB / type B), are included with the instrument.



Attention!

Observe safety information regarding the battery pack (see section 1 on page 6)!

For initial startup, first charge the battery pack and then insert it into the instrument.

The battery pack is subject to self-discharging at a rate of roughly 25% per year.



Note

Removing the Battery Pack during Periods of Non-Use

The integrated quartz movement draws power from the battery pack even when the instrument is switched off. It's advisable to remove the battery pack before long periods of non-use for this reason (e.g. vacation). This prevents excessive depletion, which may result in damage to the lithium-ion batteries under unfavorable conditions.

Charging the Battery Pack



Attention!

The battery pack must be removed from the instrument for charging (see “Removing the Battery Pack” on page 11).

- Connect the USB cable to the type B USB port on the USB power pack.
- Connect the USB cable to the micro USB port on the battery pack.
- Plug the USB power pack into an electrical outlet.

The charge LED lights up yellow during the charging process. The charging cable can be removed as soon as the charge LED lights up green at the end of the charging process.

Charging takes approximately 2 hours.

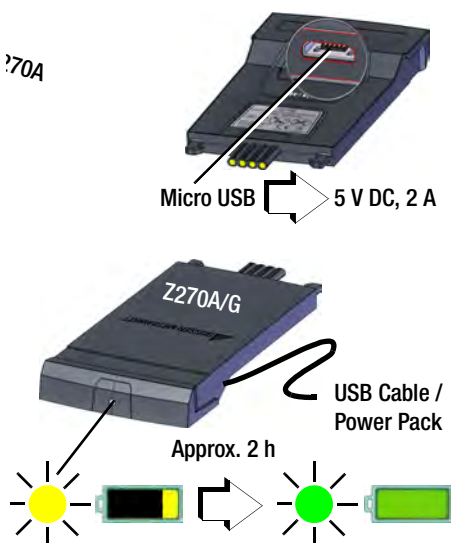

Note

The optional M27x charger (Z270L) includes primary connectors for Central Europe, the UK, North America and Asia.

Inserting the Battery Pack

The battery pack has to be reinserted after charging.

- Push the battery pack into the battery compartment on the back of the instrument until noticeable resistance is detected (a).
- Press the two locking tabs on the left and right sides of the instrument together at the same time (b) and push the battery pack to its final position.
- Release the locking tabs. The battery pack snaps into place.

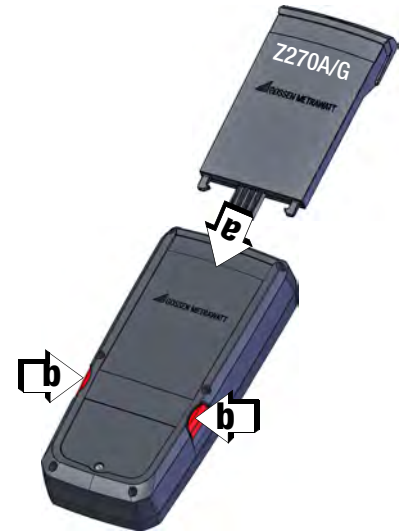

Removing the Battery Pack

Stored measurement data are not lost when the battery pack is removed. Selected operating parameters are retained in memory. Time and date, on the other hand, must be reset.



Attention!

Switch the instrument off and disconnect it from the measuring circuit before removing the battery pack.

- Simultaneously press and hold the two locking tabs (a).
- Slide the battery pack out towards the top of the instrument (b).

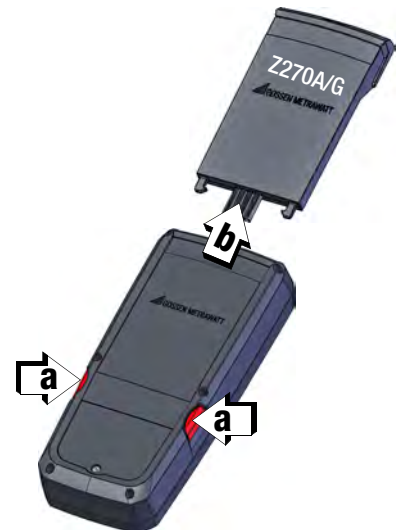

Battery Display (charge level)

The current charge level is indicated in the display at the top right (see “Connections, Keys, Rotary Switch, Symbols (depending on instrument variant)” on page 8).

The exact charge level can be queried as a percentage under **Info** in the **General Setup** menu:

- Press the **MENU** key to this end.
 - Then press the **General Setup** softkey.
- Select the **Info** parameter with the help of the $\Delta \nabla$ scroll keys.

When the USB mains module is used, the message „Adapter detected“ is displayed instead of the battery charging indicator.

Charge level symbols:

	Battery full
	Battery OK
	Battery weak Charge the battery pack as soon as possible.
	Attention! Do not perform any safety-relevant measurements if the “battery low” symbol appears in the battery display. Moreover, compliance with the specified data is no longer assured when the battery is weak.
	Battery (almost) dead, $U < 3.3\text{ V}$
	Attention! The instrument is switched off automatically.

5.2 Mains Module with USB Port

The instruments can be operated with a USB mains module (Z270E) as an alternative to the battery pack. The USB mains module is inserted into the instrument and connected to a PC via a USB-C cable, or with a USB-C cable and a USB power pack, e.g. USB PD power pack 65 W (Z270U) for mains operation.

The USB mains module is available as an optional accessory (see page 3) and may only be applied in METRAHIT IM series instruments.

Attention!
The USB mains module is only supported as of firmware version 1.006.000.
If a USB mains module is inserted in an instrument with a lower firmware version, the instrument cannot be switched on. Update the firmware before inserting the USB mains module (see section 6.2 on page 14).

Attention!
If the secondary current of the power pack is lower than 500 mA, the instrument cannot be switched on. Depending on the secondary current of the utilized power pack, measuring functions with high electrical power demand may either not be possible at all or to a limited degree only.
The full scope of functions is available with a power delivery pack.

Note
System requirements:
To assure safe operation including power supply via PC connection, a USB 3.0 port or BCP (Battery Charging Port) is recommended.
For direct mains operation, a USB power pack with at least 1.5 A output current is recommended.

Inserting the USB Mains Module

- Push the USB mains module into the mains module compartment on the back of the instrument until noticeable resistance is detected (a).
- Press the two locking tabs on the left and right sides of the instrument together at the same time (b) and push the USB mains module to its final position.
- Release the locking tabs. The USB mains module snaps into place.

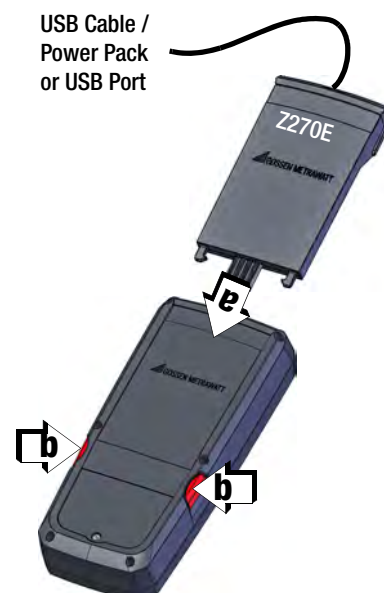

Operation with USB Mains Module

After inserting the USB mains module into the instrument, simply connect it to the power supply. Power is supplied via the included USB cable which is connected to a USB port or to the USB socket of a USB power pack with at least 1.5 A secondary current, e.g. USB PD power pack 65 W (Z270U).

Note
The optional M27x charger (Z270L) can't be used as a USB power pack. It doesn't have a connector for the type C USB cable.

Bear in mind that the length of the cable restricts your range of action.

- Connect the USB cable to the type C USB port on the USB mains module.
- Power supply via USB port:
Connect the other end of the USB charging cable to the USB port at a PC.
- Power supply via mains outlet:
Connect the other end of the USB charging cable with the type C USB port of the USB PD power pack (Z270U). Then plug the USB power pack into a mains outlet.
- The instrument is ready for operation.

Removing the USB Mains Module

Stored measurement data are not lost when the USB mains module is removed. Selected operating parameters are retained in memory.



Attention!

Switch the instrument off and disconnect it from the measuring circuit before removing the USB mains module.

- ⇨ Simultaneously press and hold the two locking tabs (a).
- ⇨ Slide the battery pack out towards the top of the instrument (b).

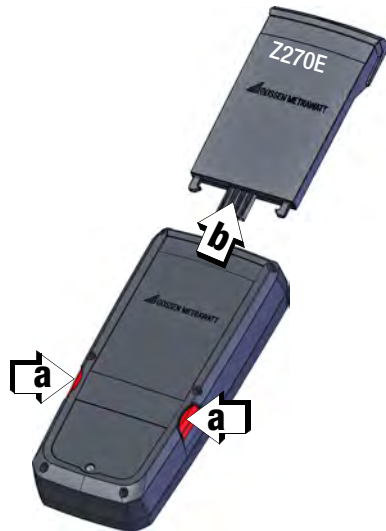

5.3 Switching the Instrument On

- ⇨ The instrument is switched on automatically after selecting any rotary switch position other than **OFF**.



Note

Electrical discharge and high frequency interference may cause incorrect displays to appear, and may disable the measuring sequence.

Disconnect the instrument from the measuring circuit. Switch the instrument off and back on again in order to reset. If this procedure is unsuccessful, briefly remove the battery pack or USB mains module (see section 5.1 and section 5.2).

6 System Settings

After initial startup, basic system settings have to be selected, for example date and time. System settings can be changed at any time.

System settings can be accessed in the **General Setup** menu.

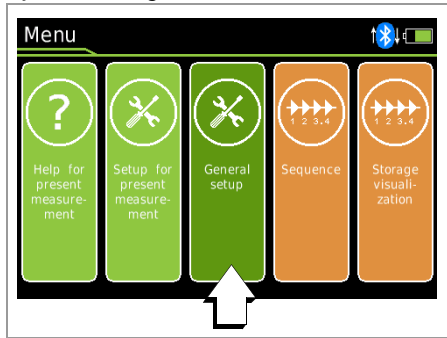

Note

If settings are selected which deviate from the default configuration, e.g. "Bluetooth = On" or "Brightness = Auto", battery operating time may be less than specified in the technical data.

6.1 Digital Keyboard

Text is entered at the instrument via a keyboard which appears at the display:

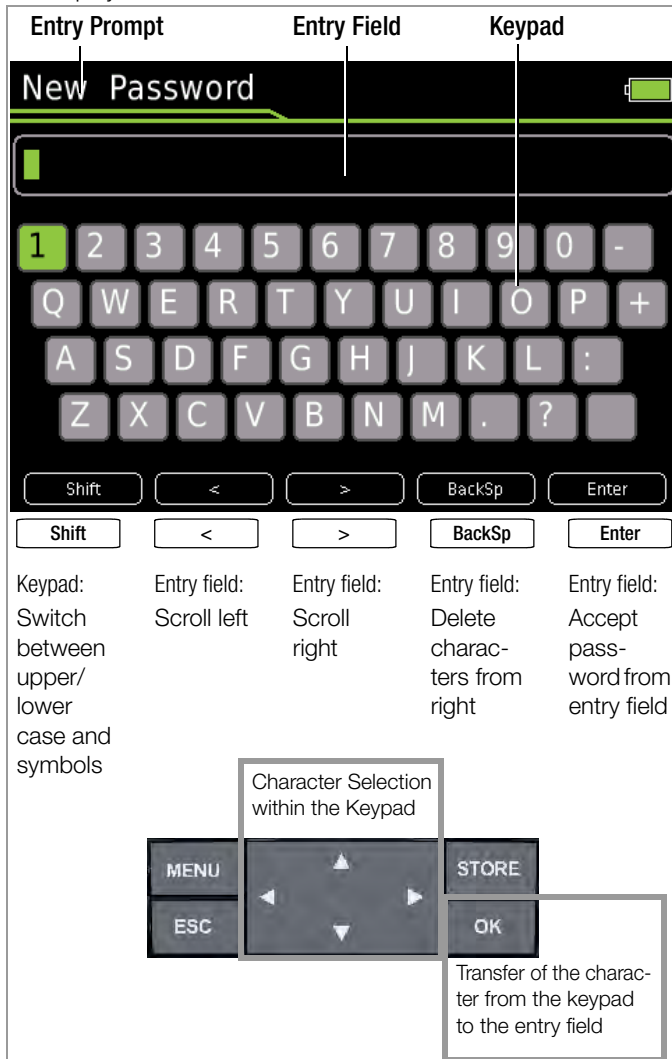

Select the individual characters from the keypad using the scroll keys. The position of the cursor is indicated by the green background at the respective key. Acknowledge the selected character by pressing the **OK** key, after which the character is transferred to the entry field. The last entered character or characters can be

deleted with the help of the **BackSp** (backspace) key. You can move the blinking cursor in the entry field to the desired position within the word using the **<** or **>** softkey in order to add characters, or to delete them with the help of the **BackSp** softkey. The **Shift** softkey can be used to switch back and forth between upper and lower case letters, as well as numbers and special characters. Finished entries are confirmed by pressing the **Enter** key.

6.2 Firmware

Viewing the Instrument's Current Firmware Version

- Press the **MENU** key.
- Press the **General Setup** softkey.
- Select the **Info** parameter with the help of the $\Delta \nabla$ scroll keys.
- The **Version** parameter indicates the current software (firmware) revision level.
- The instrument is returned to the measuring mode after pressing the **ESC** key twice.

MENU > General Setup > $\Delta \nabla$ Info > Version

Updating the Firmware

Complete information concerning current software and firmware, as well as instrument updates and options, can be found in the myGMC portal. Please register for free, after which you'll have access to the downloads and will always receive the latest information about your instrument.

<https://www.gmc-instruments.de/services/mygmc/>

In order to update the firmware, download the current firmware as a ZIP file and unpack it.



Attention!

Read and adhere to the README file. It contains complete information on supported instruments, system requirements, installation and version changes.

Follow the instructions in the README file in order to install the firmware update.



Note

Instruments with serial numbers as of GHxxxxxxxx (August 2022) also support firmware updates via the USB port with the optional M27x USB mains module (article number Z270E). Updating via the USB mains module is only possible from initially flashed firmware level 1.006.000.

6.3 Language Selection

English or German can be selected as the user interface language.

- ⇨ Press the **MENU** key.
- ⇨ Press the **General Setup** softkey.
- ⇨ Select the **Language** parameter with the help of the $\Delta \nabla$ scroll keys.
- ⇨ Switch to the settings menu with the help of the \triangleright scroll key.
- ⇨ Select the desired language with the $\Delta \nabla$ scroll keys.
- ⇨ Acknowledge by pressing the **OK** key. The input cursor jumps back to the parameters list.
- ⇨ Return to the main menu by pressing the **ESC** key or the **MENU** key.
- ⇨ The instrument is returned to the measuring mode after pressing the **ESC** key once more.



6.4 Time and Date Settings

- ⇨ Press the **MENU** key.
- ⇨ Press the **General Setup** softkey.
- ⇨ Select the **System** parameter with the help of the $\Delta \nabla$ scroll keys.
- ⇨ Switch to the submenu with the help of the \triangleright scroll key.
- ⇨ Select the **Date** or **Time** parameter with the help of the $\Delta \nabla$ scroll keys.
- ⇨ Acknowledge the selected parameter by pressing the **OK** key. The entry cursor jumps to a random position in the settings menu.
- ⇨ Select the desired entry position with the $\triangleleft \triangleright$ scroll keys and change the respective value with the $\Delta \nabla$ scroll keys.
- ⇨ Acknowledge your change with the **OK** key. The entry cursor once again marks the entire parameter line.
- ⇨ Return to the main menu by pressing the **ESC** key twice or the **MENU** key once.
- ⇨ The instrument is returned to the measuring mode after pressing the **ESC** key once more.

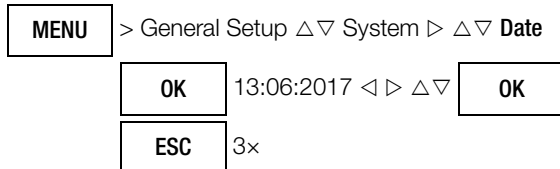
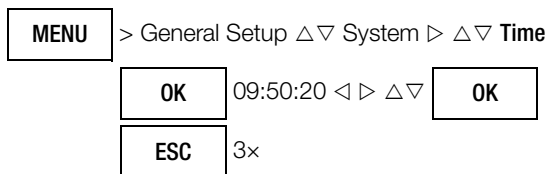

6.5 Digital Display Settings

Brightness and the display profile (light or dark mode) can be selected for the display.

6.5.1 Brightness

Brightness of the digital display can be set between 1 (minimum brightness) and 9 (maximum brightness).

It can also be set to automatic. In this case, digital display brightness is adjusted depending on the intensity of the light which strikes the brightness sensor.

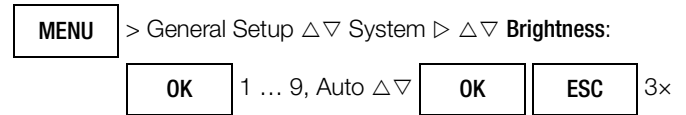

6.5.2 Display Profile

Two different views can be selected here – black lettering against a bright background (light mode) or vice versa (dark mode).

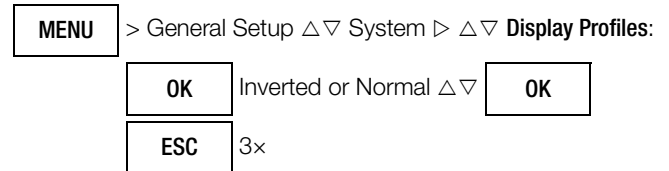

Default setting: White lettering against a dark background

6.6 Set Display of Leading Zeros

The **Display Zeros** parameter can be used to specify whether leading zeros will appear or be suppressed at the measured value display.

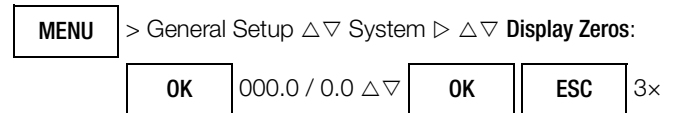

6.7 Configuring Password Protection

No password is assigned upon delivery, or after restoring the default settings.

A password can be selected if required. The following parameters are then password protected:

- RISO: Changes to test voltage (Test voltage remains permanently set after changing it with the password.)
- MΩ/4: Changes to test current (The default setting is 200 mA. Test current is reset to this value when the instrument is switched off.)

As long as the instrument remains switched on, the password only needs to be entered once. It has to be entered again after switching the instrument off.

Any password can be selected subject to the following restrictions:

Maximum length: 31 characters

Content: Any desired alphanumeric characters

The password is entered via the digital keyboard (see section 6.1 on page 14).

6.7.1 Selecting or Changing a Password

- ⇨ Press the **MENU** key.
- ⇨ Press the **General Setup** softkey.
- ⇨ Select the **System** parameter with the help of the $\Delta \nabla$ scroll keys.
- ⇨ Switch to the submenu with the help of the \triangleright scroll key.
- ⇨ Select the **Change Password** parameter with the help of the $\Delta \nabla$ scroll keys.
- ⇨ Acknowledge the selected parameter by pressing the **OK** key. **Old Password** appears in the header and the digital keyboard is displayed.

- ⇨ If a password hasn't been selected yet: Press the **Enter** softkey.
If a password has already been selected: Enter the password via the digital keyboard.
- ⇨ Press the **Enter** softkey.
New Password appears in the header and the digital keyboard is displayed.
- ⇨ Enter the (new) password.
- ⇨ Press the **Enter** softkey.
Acknowledge Password appears in the header and the digital keyboard is displayed.
- ⇨ Enter the password again.
- ⇨ Press the **Enter** softkey.
The password has been set or changed.
- ⇨ The menu mode is exited by pressing **ESC** three times and the instrument is returned to the measuring function.

MENU > General Setup $\Delta \nabla$ System $\triangleright \Delta \nabla$
Changing the Password

6.7.2 Deactivating Password Protection

A selected password can be deleted. Password protection is deactivated as a result.

- ⇨ Press the **MENU** key.
- ⇨ Press the **General Setup** softkey.
- ⇨ Select the **System** parameter with the help of the $\Delta \nabla$ scroll keys.
- ⇨ Switch to the submenu with the help of the \triangleright scroll key.
- ⇨ Select the **Change Password** parameter with the help of the $\Delta \nabla$ scroll keys.
- ⇨ Acknowledge the selected parameter by pressing the **OK** key.
Old Password appears in the header and the digital keyboard is displayed.
- ⇨ Enter the password via the digital keyboard.
- ⇨ Press the **Enter** softkey.
New Password appears in the header and the digital keyboard is displayed.
- ⇨ Press the **Enter** softkey without making any entry.
Acknowledge Password appears in the header and the digital keyboard is displayed.
- ⇨ Press the **Enter** softkey again without making any entry.
The password is deleted. The menu mode is exited by pressing **ESC** three times and the instrument is returned to the measuring function.

MENU > General Setup $\Delta \nabla$ System $\triangleright \Delta \nabla$
Changing the Password



Note

If you've forgotten your password, you can enter a new one after restoring the instrument to its default settings (see section 6.11).

6.8 Viewing the Instrument's Name

Each instrument has its own name so that several instruments can be distinguished from one another. The name consists of "MetraHit IM" and the last two elements of the instrument's hardware address.

The instrument's name must be known in order to be able to identify it, for example when it's connected to a PC.

The name cannot be changed.

- ⇨ Press the **MENU** key.
- ⇨ Press the **General Setup** softkey.
- ⇨ Select the **Interface** parameter with the help of the $\Delta \nabla$ scroll keys.
- ⇨ The **Name** parameter specifies the instrument's name.
- ⇨ The instrument is returned to the measuring mode after pressing the **ESC** key twice.

MENU > General Setup $\Delta \nabla$ Interface $\triangleright \Delta \nabla$ **Name**

6.9 Installing a Functions Expansion

You can purchase additional functions. Available functions expansions can be found under "Included Features" and "Scope of Delivery" on page 2, and in the data sheet which also contains the order information.

After concluding your purchase, you'll receive a feature key (password) which is used to enable your additional functions. The feature key has to be entered at the instrument.



Attention!

When ordering, specify the serial number of the instrument for which you would like to purchase the functions expansion. The feature key can only be used with this one specific instrument.

- ⇨ Press the **MENU** key.
- ⇨ Press the **General Setup** softkey.
- ⇨ Select the **System** parameter with the help of the $\Delta \nabla$ scroll keys.
- ⇨ Switch to the submenu with the help of the \triangleright scroll key.
- ⇨ Select the **Feature activation** parameter with the help of the $\Delta \nabla$ scroll keys.
- ⇨ Acknowledge by pressing the **OK** key.
A list of possible function expansions appears. Additional functions which have not been enabled are identified in the list by means of a red padlock.
- ⇨ Select the previously purchased function expansions with the help of the $\Delta \nabla$ scroll keys.
- ⇨ Press the **Activate** softkey.
Password appears in the header and prompts you to enter your feature key.
- ⇨ Enter the feature key using the digital keyboard. The digital keyboard is described in section 6.1, "Digital Keyboard" on page 15.
- ⇨ Acknowledge your entry by pressing the **Enter** softkey,
- ⇨ Successful enabling is confirmed by a message. The enabled additional functions are then identified in the list by means of a green checkmark.

MENU > General Setup $\Delta \nabla$ System $\triangleright \Delta \nabla$ **Feature activation**

6.10 Switching the Instrument Off

The instrument can be switched off manually. The instrument switches itself off automatically as well (auto off).

6.10.1 Switching the Instrument Off Manually

- ⇨ The instrument is switched off automatically by setting the rotary switch to the **OFF** position. The display goes blank.

6.10.2 Automatic Shutdown (auto-off)

The period of time after which the instrument is shut down automatically, regardless of whether a measurement or menu view is open, can be set to a value within a range of 10 to 59 minutes. Alternatively, automatic shutdown can be deactivated for continuous operation.

The instrument is switched off automatically if the measured value remains unchanged for a long period of time (maximum measured value fluctuation of approx. 0.8% of the measuring range per minute or 1°C or 1 °F per minute), and if none of the keys or the rotary switch have been activated before a selected period of time in minutes has elapsed.



Note

Exceptions:

Transmission and memory mode operation, continuous operation and whenever a dangerous voltage is applied to the input (U > 15 V AC or U > 25 V DC).

Shutdown is acknowledged with a brief acoustic signal.

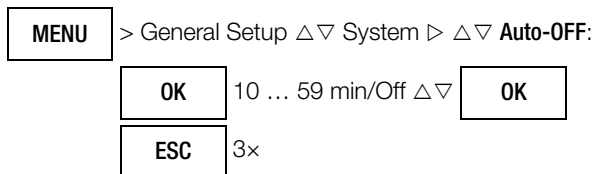

6.11 Default Settings (instrument reset)

All of the settings which you have changed can be returned to their default settings here.



Note

Password protection is also reset, i.e. deactivated.



Note

Test sequences (see section 8.16 on page 54) are retained.

- ⇨ Press the **MENU** key.
- ⇨ Press the **General Setup** softkey.
- ⇨ Select the **System** parameter with the help of the Δ∇ scroll keys.
- ⇨ Switch to the submenu with the help of the ▷ scroll key.
- ⇨ Select the **Default Settings** parameter with the help of the Δ∇ scroll keys.
- ⇨ Acknowledge by pressing the **OK** key.
- ⇨ The following warning appears: "Reset?". The settings are not reset until you scroll to **Yes** with the < scroll key and acknowledge by pressing **OK**. Resetting can be aborted by scrolling to **No** with the ▷ scroll key and pressing **OK**.

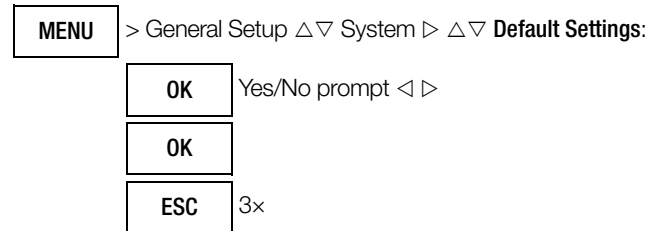

7.2 Selecting Measuring Functions and Measuring Ranges

7.2.1 Automatic Range Selection

The multimeter is equipped with auto-ranging for all measuring functions except for temperature measurement, as well as diode and continuity testing. Auto-ranging is active as soon as the instrument is switched on. The instrument automatically selects the measuring range which allows for highest possible resolution of the applied quantity. When the instrument is switched to frequency measurement, the previously selected voltage measuring range remains active.

AUTO-Range Function

The multimeter is switched automatically to the next higher range at $\pm(3099 d + 1 d \rightarrow 0310 d)$, and to the next lower range at $\pm(280 d - 1 d \rightarrow 2799 d)$.

In the case of high resolution (available depending upon measuring function), the multimeter is switched automatically to the next higher range at $\pm(30,999 d + 1 d \rightarrow 03100 d)$, and to the next lower range at $\pm(2800 d - 1 d \rightarrow 27,999 d)$.

7.2.2 Manual Range Selection

Auto-ranging can be deactivated and measuring ranges can be selected manually in accordance with the following table by pressing the **Man / Auto** button.

The desired measuring range can then be selected with the \triangleleft or \triangleright scroll key.

The instrument is automatically returned to automatic range selection when the **Man / Auto** key is pressed, the rotary switch is activated or the instrument is switched off and back on again.

Overview: Auto-Ranging and Manual Range Selection

	Function	Display
Man / Auto	Manual mode active: utilized measuring range is fixed	Man
\triangleleft or \triangleright	Range switching sequence for: V: 300 mV* \leftrightarrow 3 V \leftrightarrow 30 V \leftrightarrow 300 V \leftrightarrow 1000 V Hz: 300 Hz \leftrightarrow 3 kHz \leftrightarrow 30 kHz \leftrightarrow 300 kHz (Hz(U)) Ω: 300 Ω \leftrightarrow 3 k Ω \leftrightarrow 30 k Ω \leftrightarrow 300 k Ω \leftrightarrow 3 M Ω \leftrightarrow 30 M Ω A: 300 μ A \leftrightarrow 3 mA \leftrightarrow 30 mA \leftrightarrow 300 mA \leftrightarrow 1 A A \mathcal{A}: 0.3 A \leftrightarrow 3 A \leftrightarrow 30 A \leftrightarrow 300 A F: 30 nF \leftrightarrow 300 nF \leftrightarrow 3 μ F \leftrightarrow 30 μ F \leftrightarrow 300 μ F RISO: 300 k Ω \leftrightarrow 3 M Ω \leftrightarrow 30 M Ω \leftrightarrow 300 M Ω \leftrightarrow 3000 M Ω	Man
Man / Auto	Return to automatic measuring range selection	Auto

* Only via manual range selection for V AC

The multimeter is held in the selected measuring range. If the range limit is exceeded, "OL" appears at the display. You should then switch to the next higher measuring range with the help of the \triangleright scroll key.

7.2.3 Quick Measurements

Measurements performed using a suitable fixed measuring range are executed more quickly than those which utilize automatic range selection. Quick measurement is made possible with the following two functions:

- **Manual measuring range selection**, i.e. by selecting the measuring range with the best resolution (see section 7.2.2)

or

- With the **DATA function** (see section 7.5) In this way, the appropriate measuring range is selected automatically after the first measurement and the second measurement is executed more quickly.

The selected measuring range remains active for the subsequent series of measurements with these two functions.

7.3 Zero Offset / Relative Measurements

Zero offset or a reference value for relative measurements can be stored to memory depending upon deviation from the zero point:

Deviation from zero point – with short-circuited measurement cables for V, Ω , A – with open input for capacitance unit of measure F	Display
0 ... 200 digits	ZERO

The relevant reference or correction value is deducted individually for the respective measuring function as an offset from all future measurements and remains in memory until deleted, or until the multimeter is switched off.

Zero balancing and reference value adjustment can be used with auto-ranging, as well as for manual measuring range selection.

Note:

Zero offset is available for the following measuring functions and switch positions: RISO, Coil, DAR, PI, Hz, Duty AC, RPM AC, Ω , Temp RTD (the RLeads function is offered here as an alternative), Temp TC, Continuity, Diode, $R_{LO}/2L$ (ZERO is also activated after pressing the START key!) and $R_{LO}/4W$ (the thermal compensation function is offered here as an alternative).

Zero Balancing

- \triangleright Plug the measuring cables into the instrument and connect the free ends to each other, except for capacitance measurement and current measurement in which case the ends of the cables are not connected to each other.
- \triangleright Briefly press the **Zero** softkey.
The value measured at the moment the key is pressed serves as a reference value. The instrument acknowledges zero balancing with an acoustic signal, and "Zero" and the reference value appear at the display. The **Zero** softkey is displayed with a green background.
- \triangleright Zero balancing can be cleared by once again pressing the **Zero** softkey.



Note

As a result of TRMS measurement, the multimeter displays a residual value of 1 to 10/35 digits with short-circuited measurement cables as the zero point for V AC / I AC or V (AC+DC) / I (AC+DC) measurements (non-linearity of the TRMS converter). This has no influence on specified accuracy above 1% of the measuring range (or 3% in the mV, V (AC+DC) ranges).

Setting the Reference Value

- \triangleright Connect the measuring cables to the instrument and measure a reference value (max. 50% of the measuring range).
- \triangleright Briefly press the **Zero** softkey.
The instrument acknowledges storage of the reference value with an acoustic signal and the "ZERO" symbol appears at the display. The value measured at the moment the key is pressed serves as a reference value.
- \triangleright The reference value can be cleared by once again pressing the **Zero** softkey.

Notes Regarding Relative Measurement

- Relative measurement effects the digital display only. The analog display continues to read out the original measured value.
- In the case of relative measurement, Ω F or AC quantities may also appear as negative values.

7.4 Display (TFT)

7.4.1 Digital Display

Measured Value, Unit of Measure, Type of Current, Polarity

The measured value with correct decimal and plus or minus sign appears at the digital display. The selected unit of measure and current type are displayed as well. A minus sign appears to the left of the value during the measurement of zero-frequency quantities, if the plus pole of the measured quantity is applied to the "L" input.

The **Display Zeros** parameter can be used to determine whether leading zeros will appear or be suppressed at the measured value display (see section 6.6).

Exceeded Measuring Range

If the upper range limit of 1000 digits is exceeded, "OL" (overload) appears at the display.

Exceptions: "OL" appears at the display as of 1030.0 V in the case of voltage measurement in the 1000 V range, as of 4.500 V for diode testing and as of 1.100 A in the 1 A range.

7.4.2 Analog Display

Measured Value, Polarity

The analog display emulates the dynamic performance of a moving-coil mechanism. This display is especially advantageous for observing measured value fluctuation, and for balancing procedures.

Display as a horizontal (green) bar which indicates the momentary measured value in real-time.

The analog scale displays a small negative range for the measurement of zero-frequency quantities with positive measured values, allowing for precise observation of measured value fluctuation around zero. If the measured value exceeds a certain negative range, polarity is reversed at the analog display.

The analog scale displays a small positive range for the measurement of zero-frequency quantities with negative measured value, allowing for precise observation of measured value fluctuation around zero in this case as well.

Scaling of the analog scale is automatic. This is very helpful for manual measuring range selection.

Exceeded Measuring Range

Exceeding the measuring range is indicated exclusively via the digital display.

Refresh Rate

The analog display is refreshed 40 times per second.

7.5 Measured Value Storage – Data Function (Auto-hold/Compare)

General

An individual measured value can be automatically "frozen" with the DATA function (auto-hold).

Applications

This function is useful, for example, when contacting the measuring points with the test probes requires your full attention. After the measuring signal has been applied and the measured value has settled in accordance with the "condition" listed in the table below, the measured value is frozen at the digital display and an acoustic signal is generated. The test probes can now be removed from the measuring points and the measured value can be read from the digital display. If the measuring signal falls below the value specified in the table, the function is reactivated for storage of the next value.

The **Data** function can be activated in all measuring functions. This is possible for the following functions after measurement has been started: RISO, $R_{LO}/2L$ and $R_{LO}/4L$.

Procedure

Apply the measured quantity to the instrument and set the measuring range with the **Man / Auto** softkey before activating the **Data** function with the **Data / MinMax** softkey. **Man** appears at the display with a green background. After activating the **Data** function with the corresponding softkey, **Man** is grayed out and cannot be changed until **Data / MinMax** is pressed again three times for deactivation. **Data** appears at the display with a green background. If automatic measuring range selection was active prior to activation of the **Data** function, switching to manual measuring range selection is also disabled as long as the **MinMax** function is active.

Data and the associated value appear between the digital and analog displays.

Measured Value Comparison (DATA Compare)

If the currently frozen value deviates from the first saved value by less than 100 digits, the acoustic signal is generated twice. If deviation is greater than 100 digits, only a brief acoustic signal is generated.



Note

The **Data** function has no effect on the analog display, at which the current measured value continues to appear. However, when the digital display is "frozen", the decimal point is fixed as well (fixed measuring range, **Man** appears with a gray-green background).

The selected measuring range cannot be manually changed as long as the **Data** function is active.

The **Data** function is deactivated by briefly pressing the **Data / MinMax** softkey three times, if you switch to the **MinMax** function, when the measuring function is changed or when the instrument is switched off and back on again.

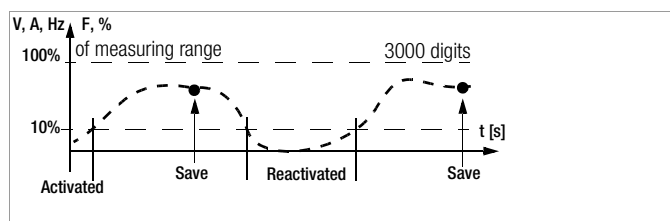

Function Data	Key Data / MinMax	Condition		Response from Instrument	
		Measuring Function	Measuring Signal	Display Data + MV	Acoustic
Activate	short			is displayed	1 ×
Save (stabilized measured value)		V, A, F, Hz, %	> 10% MR	is displayed	1 ×, 2 × ²
			≠ 0L		
Reactivate ¹		V, A, F, Hz, %	< 10% MR	stored MV	
			= 0L		
Change to MinMax	short			is cleared	1 ×

¹ Reactivation results from falling short of specified measured value limits.

² Two acoustic signals are generated the first time a measured value is saved as a reference value. For subsequent data hold, two acoustic signals are only generated if the currently frozen value deviates from the **first** saved value by less than 100 digits.

Key: MV = measured value, MR = measuring range

Example

The voltage measuring range is set manually to 30 V. The first measured value is 5 V and is stored to memory because it's greater than 10% of the measuring range (= 3 V), and is thus reliably above the background noise level. As soon as the measured value drops to less than 10% of the measuring range, i.e. amounts to less than 3 V which corresponds to removal of the test probes from the measuring point, the instrument is ready to store a new value.

7.5.1 Saving Minimum and Maximum Values – “MinMax”

General

Minimum and maximum measured values applied to the measuring instrument's input after the **MinMax** function has been activated can be “frozen” at the display.

Applications

The most important use of this function is the determination of minimum and maximum values during long-term measured value observation. The **MinMax** function can be activated in all measuring functions. This is possible for the following functions after measurement has been started: RISO, $R_{I0}/2L$ and $R_{I0}/4L$.

The **MinMax** function has no effect on the analog display, at which the current measured value continues to appear.

Procedure

Apply the measured quantity to the instrument and set the measuring range with the **Man / Auto** softkey before activating the **MinMax** function with the **Data / MinMax** softkey. **Man** appears at the display with a green background. After activating the **MinMax** function with the corresponding softkey, **Man** is grayed out and cannot be changed until **MinMax** is pressed again for deactivation. **MinMax** appears at the display with a green background. If automatic measuring range selection was active prior to activation of the **MinMax** function, switching to manual measuring range selection is also disabled as long as the **MinMax** function is active.

Both **Min** and **Max**, as well as the associated values, are displayed between the digital and analog displays along with the time of their occurrence.

The **MinMax** function is deactivated by briefly pressing the **Data / MinMax** softkey, when the measuring function is changed or when the instrument is switched off and back on again.



Note

As opposed to the **Data** function, the **MinMax** function can also be used for temperature measurement.

The MinMax function is reset by pressing the **ESC** key.

After pressing **Data / MinMax** once again, the minimum and maximum values are displayed together with the average value (“Avg.”). The Min Avg Max display appears without timestamp.

Function MinMax	Key Data / MinMax	Min. and Max. Measured Values	Response from Instrument	
			Display Min + MV Max + MV	Acoustic Signal
Activate and save	short	are saved	momentary measured value	1 ×
Save and display		Storage continues in background, new min. and max. values are displayed.	stored min. value	1 ×
			stored max. value	1 ×
Stop	short	are deleted	is cleared	1 ×

7.6 Measured Value Memory – STORE Function.

The following options are available for the storage of measured values:

- Store at the instrument by pressing the **STORE** key on the instrument
- Store at the instrument by pressing the **STORE** key on the probe (METRAHIT IM XTRA BT and METRAHIT IM E-DRIVE BT only)
- Store at the PC by triggering the **PUSH/PRINT** function in the **IZYTRONIQ** report generating program

7.6.1 Remote read-out and storage via the Z270S probe (METRAHIT IM XTRA BT and METRAHIT IM E-DRIVE BT only)

The probe with integrated control unit permits remote triggering at difficult to access places, and at locations which require your full attention. The probe can be used for all measuring functions except for current measurement. The connector cable is shielded against interference.

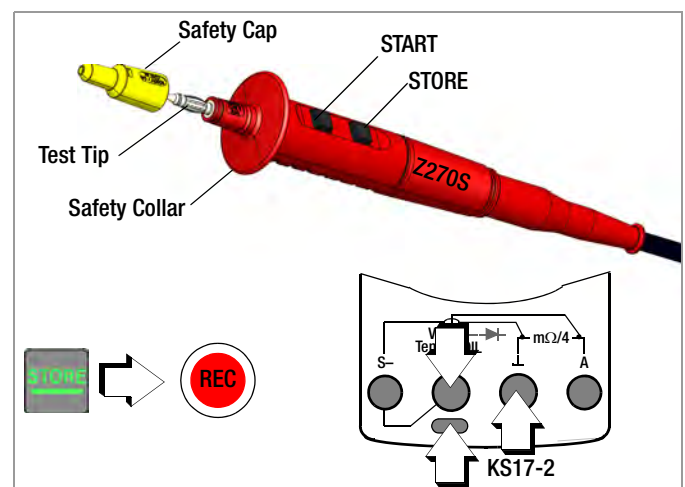

- ⇨ Connect the probe's double plug to the voltage socket (V).
- ⇨ Connect the KS17-2 safety measurement cable to the ground socket.
- ⇨ Establish contact with the measuring point.
- ⇨ Start the respective measuring function by pressing the **START** key on the probe.
- ⇨ As soon as the measured value has settled in, it can be stored by pressing the **STORE** key on the probe. Alternatively, the measured value can be stored with the help of the **STORE** key on the instrument.

The **REC** storage symbol appears briefly in the header in order to visualize the storage process.

Electrical Safety

Maximum rated voltage	300 V	600 V	600 V
Measuring category	CAT IV	CAT III	CAT II
Maximum rated current	1 A	1 A	16 A
With safety cap attached	•	•	—
Without safety cap	—	—	•

Measurements per DIN EN 61010-031 may only be performed in environments in accordance with measuring categories III and IV with the **safety cap** attached to the control unit's test tip.

In order to **establish contact inside 4 mm sockets**, the safety cap has to be removed by prying open the snap fastener with a pointed object (e.g. the other test probe).

7.6.2 Remote Read-Out and Storage via the PC – PUSH/PRINT Function

The procedure for storage via the **PUSH/PRINT** function is described in the online help included with **IZYTRONIQ** report generating software.

7.7 Measurement Data Recording

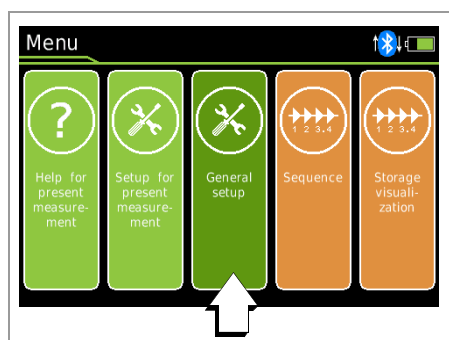

The multimeter offers the option of saving measurement data once by pressing a button or repeatedly as a measurement series over longer periods of time.

Data are stored to a battery-backed memory module, and are retained even after the multimeter is switched off. The system acquires measured values relative to real-time.



Note

Measurement data recording is ended automatically as soon as internal memory is full. No measurement data are overwritten. Memory has to be cleared in order to record further measurement data (see page 24).

Stored measurement data can be read out via Bluetooth® or the USB port on the optional USB mains module. See also interface operation in section 9 on page 57.

Refer to section 7.6 on page 21 concerning storage of current data to **IZYTRONIQ** software.

7.7.1 One-Time Only (manual) Storage

The **STORE** key is used for on-time only storage of a data value. Recording type must be set to "Data Value".

- ⇨ Press the **MENU** key.
- ⇨ Press the **General Setup** softkey.
- ⇨ Select the **Memory** menu with the $\Delta \nabla$ scroll keys.
- ⇨ Switch to the submenu with the help of the \triangleright scroll key.
- ⇨ Select the **Recording Type** parameter with the help of the $\Delta \nabla$ scroll keys.
- ⇨ Acknowledge the selected parameter by pressing the **OK** key.
- ⇨ Select the **Data Value** parameter with the help of the $\Delta \nabla$ scroll keys.
- ⇨ Acknowledge your change with the **OK** key. The entry cursor once again marks the entire parameter line.

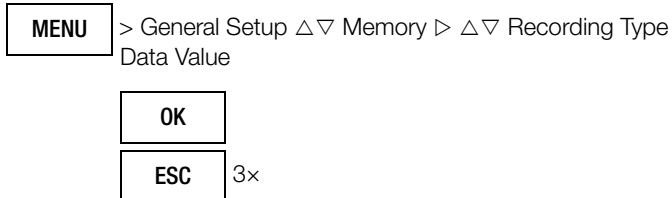

7.7.2 Measurement Series (automatic storage)

Recording type must first be set to "Periodic" for measurement series, and several basic parameters have to be set, for example the sampling rate.



Note

Consider available memory space when selecting your settings (see page 24).

Afterwards, you can start memory mode operation and then the measuring function at any time.

The general procedure is described here first, and the following subsections explain the respective parameters and their configuration in detail.

- ⇨ Activate recurrent recording:
 - ⇨ Press the **MENU** key.
 - ⇨ Press the **General Setup** softkey.
 - ⇨ Select the **Memory** menu with the $\Delta \nabla$ scroll keys.
 - ⇨ Switch to the submenu with the help of the \triangleright scroll key.
 - ⇨ Select the **Recording Type** parameter with the help of the $\Delta \nabla$ scroll keys.
 - ⇨ Acknowledge the selected parameter by pressing the **OK** key.
 - ⇨ Select the **Periodic** parameter with the help of the $\Delta \nabla$ scroll keys.
 - ⇨ Acknowledge your change with the **OK** key. The entry cursor once again marks the entire parameter line.
- ⇨ Set the sampling rate for memory mode operation (see page 23).
- ⇨ Set recording time (see page 23).
- ⇨ Select an hysteresis in order to assure efficient use of memory capacity (see page 23).
- ⇨ Select a trigger function if required (see page 23).
- ⇨ Create a group if necessary in order to store the measured values in a sorted manner (see page 24).
- ⇨ Check current memory occupancy (see page 24).
- ⇨ Before starting lengthy measured value recordings, check the battery's charge level (see section 5.1), or use the USB mains module (see section 5.2).
- ⇨ Start recording.
 - ⇨ Press the **MENU** key.
 - ⇨ Press the **General Setup** softkey.
 - ⇨ Select the **Memory** menu with the $\Delta \nabla$ scroll keys.
 - ⇨ Switch to the submenu with the help of the \triangleright scroll key.
 - ⇨ Select the **Recording Start** parameter with the $\Delta \nabla$ scroll keys.
 - ⇨ Acknowledge the selected parameter by pressing the **OK** key. The "Start" setting changes to "Stop". The following message appears: "Recording has started." At the same time, "REC" appears in red to the left of the battery level display.
 - ⇨ The display is returned to the measuring function by pressing the **ESC** key three times.

- ⇨ Select the desired measuring function and an appropriate measuring range.
- ⇨ Perform the measurement.
- ⇨ Stop recording:
 - ⇨ Press the **MENU** key.
 - ⇨ Press the **General Setup** softkey.
 - ⇨ Select the **Memory** menu with the $\Delta \nabla$ scroll keys.
 - ⇨ Switch to the submenu with the help of the \triangleright scroll key.
 - ⇨ Select the **Recording Stop** parameter with the $\Delta \nabla$ scroll keys.
 - ⇨ Acknowledge the selected parameter by pressing the **OK** key.
The following message appears: "Recording has stopped". The red "REC" symbol is cleared from the display.
 - ⇨ The display is returned to the measuring function by pressing the **ESC** key three times.
 - ⇨ Memory mode operation can also be exited by switching the multimeter off.

Setting the Sampling Rate

This parameter cannot be set during memory mode operation.

- ⇨ Press the **MENU** key.
- ⇨ Press the **General Setup** softkey.
- ⇨ Select the **Memory** menu with the $\Delta \nabla$ scroll keys.
- ⇨ Switch to the submenu with the help of the \triangleright scroll key.
- ⇨ Select the **Rate** parameter with the $\Delta \nabla$ scroll keys.
- ⇨ Acknowledge the selected parameter by pressing the **OK** key.
- ⇨ Change the respective value using the $\Delta \nabla$ scroll keys [h:mm:ss] or [mm:ss/s/10].
- ⇨ Acknowledge your change with the **OK** key. The entry cursor once again marks the entire parameter line.



Adjusting Recording Time

Recording time can be set to **Unlimited** or to a value within a range of 0:00:00 to 90:00:00.

This parameter cannot be set during memory mode operation.

- ⇨ Press the **MENU** key.
- ⇨ Press the **General Setup** softkey.
- ⇨ Select the **Memory** menu with the $\Delta \nabla$ scroll keys.
- ⇨ Switch to the submenu with the help of the \triangleright scroll key.
- ⇨ Select the **Record Time** parameter with the $\Delta \nabla$ scroll keys.
- ⇨ Acknowledge the selected parameter by pressing the **OK** key.
- ⇨ Change the respective value using the $\Delta \nabla$ scroll keys [h:mm:ss].
- ⇨ Acknowledge your change with the **OK** key. The entry cursor once again marks the entire parameter line.

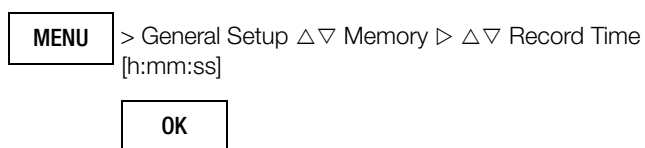

Setting Hysteresis

The hysteresis setting allows for efficient use of memory space. During memory mode operation, new measured data are only saved if they deviate from the previously stored value by an amount which exceeds the selected hysteresis value.

Hysteresis can be selected in steps from 1 to 10,000 digits. These digits are related to the measuring range as follows: the position of the selected digit in the specified hysteresis value corresponds to the same position within the measuring range, although counting is started at the left.

Example: A specified hysteresis of 00100 for the 300.00 V measuring range means that only those measured values which deviate from the last measured value by more than 001.00 V are saved to memory.



Note

Due to the fact that the value is specified in digits (highest place all the way to the left), and thus depends on the measuring range, it's advisable to use the function with a fixed measuring range only.

This parameter cannot be set during memory mode operation.

- ⇨ Press the **MENU** key.
- ⇨ Press the **General Setup** softkey.
- ⇨ Select the **Memory** menu with the $\Delta \nabla$ scroll keys.
- ⇨ Switch to the submenu with the help of the \triangleright scroll key.
- ⇨ Select the **Hysteresis** parameter with the help of the $\Delta \nabla$ scroll keys.
- ⇨ Acknowledge the selected parameter by pressing the **OK** key.
- ⇨ If the parameter is set to off, activate hysteresis by a pressing the Δ scroll key.
- ⇨ Then select the desired entry position within the parameter using the $\triangleleft \triangleright$ scroll keys and change the respective value (00000 digits) with the $\Delta \nabla$ scroll keys.
- ⇨ Acknowledge your change with the **OK** key. The entry cursor once again marks the entire parameter line.



- ⇨ Hysteresis is deactivated again by selecting the first digit or the leading zero of the displayed hysteresis value, pressing the ∇ scroll key and acknowledging with **OK**.

Trigger Mode Operation

The **Off**, **Outside Limits** and **Inside Limits** settings can be used to specify how measured value recording is started and stopped:

- **Trigger = Off:** Storage is started with **Recording > Start** and ended with **Recording > Stop**.
- **Trigger = Outside Limits:** Recording is started as soon as a measured value occurs which is outside of the selected measuring limits, and is stopped as soon as this is no longer the case, or after selected **Record Time** is exceeded.
- **Trigger = Inside Limits:** Recording is started as soon as a measured value occurs which is within a specified band, and is stopped as soon as this is no longer the case, or after maximum **Record Time** has elapsed.

The band is specified with the help of the lower trigger limit (**Trigger Low Limit**) and the upper trigger limit (**Trigger High Limit**). The limits are entered in digits and are defined by the upper range limit. In the case of DC, for example, this is 30.000 (-30.000 to +30.000). For measuring functions with a minimal measuring-range span, for example R_{LO} or $m\Omega/4$ with 3000 digits, setting the trigger

threshold above this measuring range limit does not make sense. It's thus advisable to perform measurement with a fixed measuring range.

Actual measurement is always executed using the selected sampling rate.



Note

Measurements performed close to the trigger level may result in an incorrect display. If this is the case, select a smaller voltage measuring range. In the case of measured values which are much higher than the expected results, the input signal may be distorted. Perform measurement with activated 1 kHz low-pass filter in this case.

Activating the Trigger

The trigger function cannot be set during memory mode operation.

- ⇨ Press the **MENU** key.
- ⇨ Press the **General Setup** softkey.
- ⇨ Select the **Memory** menu with the $\Delta\nabla$ scroll keys.
- ⇨ Switch to the submenu with the help of the \triangleright scroll key.
- ⇨ Select the **Trigger** parameter with the $\Delta\nabla$ scroll keys.
- ⇨ Acknowledge the selected parameter by pressing the **OK** key.
- ⇨ Select the respective function (within, outside or off) with the help of the $\Delta\nabla$ scroll keys.
- ⇨ Acknowledge your change with the **OK** key. The entry cursor once again marks the entire parameter line.

MENU > General Setup $\Delta\nabla$ Memory \triangleright $\Delta\nabla$ Trigger
OK

Adjusting the Trigger Threshold

These parameters cannot be set during memory mode operation.

- ⇨ Press the **MENU** key.
- ⇨ Press the **General Setup** softkey.
- ⇨ Select the **Memory** menu with the $\Delta\nabla$ scroll keys.
- ⇨ Switch to the submenu with the help of the \triangleright scroll key.
- ⇨ Select the **Trigger Low Limit** or **Trigger High Limit** parameter with the help of the $\Delta\nabla$ scroll keys.
- ⇨ Acknowledge the selected parameter by pressing the **OK** key.
- ⇨ Select the desired entry position within the parameter using the \triangleleft \triangleright scroll keys and change the respective value with the $\Delta\nabla$ scroll keys.
- ⇨ Acknowledge your change with the **OK** key. The entry cursor once again marks the entire parameter line.

MENU > General Setup $\Delta\nabla$ Memory \triangleright $\Delta\nabla$ Trigger Low Limit +00000 digits / Trigger High Limit +00000 digits
OK

Managing Groups

Groups can be created in order to be able to sort measured values when they're saved. The groups can be managed.

- ⇨ Press the **MENU** key.
- ⇨ Press the **General Setup** softkey.
- ⇨ Select the **Memory** menu with the $\Delta\nabla$ scroll keys.
- ⇨ Switch to the submenu with the help of the \triangleright scroll key.

- ⇨ Select the **Groups** parameter with the help of the $\Delta\nabla$ scroll keys.
- ⇨ Acknowledge the selected parameter by pressing the **OK** key.
- ⇨ Manage the groups with the help of the **New**, **Edit** and **Delete** softkeys.
 Entries are made via the digital keyboard (see section 6.1).

MENU > General Setup $\Delta\nabla$ Memory \triangleright $\Delta\nabla$ Groups

Selecting a Group

Before starting the respective measurement, select a suitable group from the list you've created to which the measured values will be saved.

- ⇨ Press the **MENU** key.
- ⇨ Press the **General Setup** softkey.
- ⇨ Select the **Memory** menu with the $\Delta\nabla$ scroll keys.
- ⇨ Switch to the submenu with the help of the \triangleright scroll key.
- ⇨ Select the **Groups** parameter with the help of the $\Delta\nabla$ scroll keys.
- ⇨ Acknowledge the selected parameter by pressing the **OK** key.
- ⇨ Select the desired group with the $\Delta\nabla$ scroll keys.
- ⇨ Acknowledge your selection with the **Select** softkey.

MENU > General Setup $\Delta\nabla$ Memory \triangleright $\Delta\nabla$ Groups
 \triangleright $\Delta\nabla$ Select

7.7.3 Memory

Memory space in the instrument is limited to 300,000 measured values. You can check memory occupancy and clear memory if necessary.

Querying Memory Occupancy

You can query memory occupancy from within the "Info" menu before, as well as during the save operation.

Memory occupancy range: 000.1% ... 999.9%.

MENU > General Setup $\Delta\nabla$ Info > Memory Occupancy x.x%

Clearing Memory (deleting measured values)

This function deletes all measured values from memory!

This function cannot be executed during memory mode operation.

MENU > General Setup $\Delta\nabla$ Memory \triangleright $\Delta\nabla$ Clear Memory

The following security prompt appears before memory is cleared: "Clear memory?". This prompt must be acknowledged with "Yes" via the function key (not with OK).

Confirmation is displayed at the end of the operation: "Memory has been cleared."



7.8 Memory Visualization (only with METRAHIT IM GRAPH expansion)

Saved measurements are listed in the memory visualization.

MENU > Memory Visualization

The list includes icons for measurement type, date, time, measurement function and group (see "Managing Groups" on page 24).

The icons have the following meanings:

Icon	Meaning
	Measurement series (automatic storage)
	Single measurement
	Sequence

You can scroll through the list using the **Page** Δ /**Page** ∇ keys, search for a date and filter according to a sequence or group.

All data saved for the selected measurement can be displayed by pressing the **OK** key.

In the case of a measurement series, the characteristic measurement curve is displayed graphically and can be analyzed (see "Data Display for Measurement Series" on page 25).

Date Search

The date search jumps to the first entry in the list with the specified date, or the one closest to it.

Filters

When using filters, only the measurements which match the filter criteria are displayed.

The Group filter can be used to filter according to groups which are available under General Setup > Memory > Groups.

The Sequence and Group filters can be used simultaneously. The softkey of an active filter turns green.

7.8.1 Data Display for Measurement Series

Overview

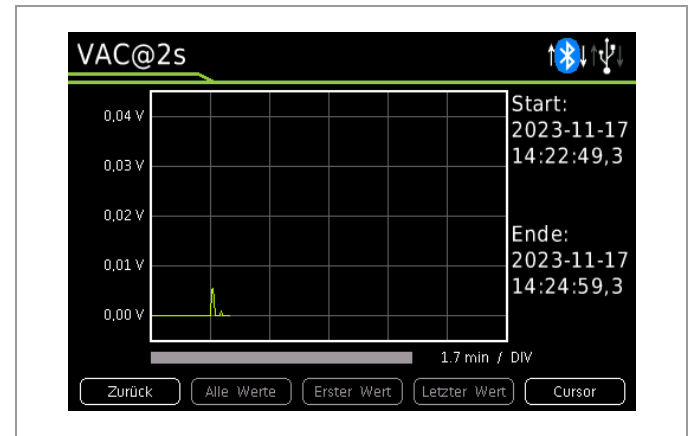

Type of measurement and storage rate are displayed in the header (see "Setting the Sampling Rate" on page 23).

The time at which the measurement was started and ended is displayed to the right of the diagram.

The time scale is displayed underneath the diagram.

Key	Meaning
Softkeys	
Back	Displays the list of stored measurements.
All Values	The entire course of the measurement is displayed (only when the display is enlarged).
First Value	The display jumps to the beginning of the measurement (only when the display is enlarged).
Last Value	The display jumps to the end of the measurement (only when the display is enlarged).
Cursor	Switches to the "Cursor" display (see page 26).
Hard Keys	
Δ ∇	Zoom + / Zoom -
\triangleright	Shifts the display of measurement data to the right.
\triangleleft	Shifts the display of measurement data to the left.

Cursor

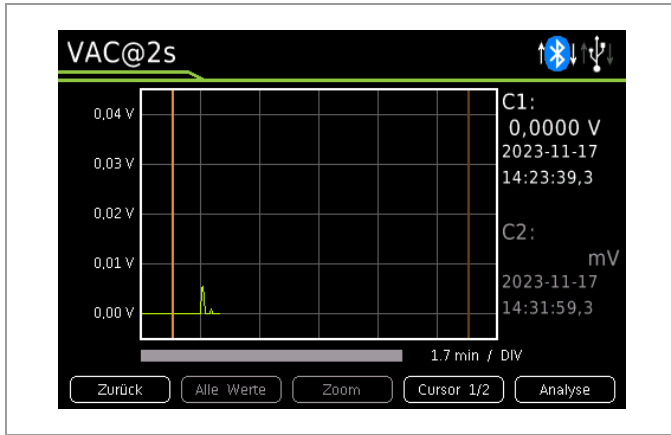

The measured values at cursor 1 (C1) and cursor 2 (C2) are displayed to the right of the diagram.

Key	Meaning
Softkeys	
Back	Returns to the "Overview" screen (see page 25).
All Values	The entire course of the measurement is displayed (only when the display is enlarged).
Zoom	Zooms the display to the area between cursor 1 and cursor 2.
Cursor 1/2	Toggle between cursor 1 and cursor 2. The selected cursor and the associated measured value are highlighted.
Analysis	Switches to the "Analysis" screen (see page 26).
Hard Keys	
△ ▽	Zoom + / Zoom -
▷	Brief: Shifts the selected cursor one pixel to the right. Long: Shifts the selected cursor continuously to the right for as long as the hard key is pressed.
◁	Brief: Shifts the selected cursor one pixel to the left. Long: Shifts the selected cursor continuously to the left for as long as the hard key is pressed.

Analysis

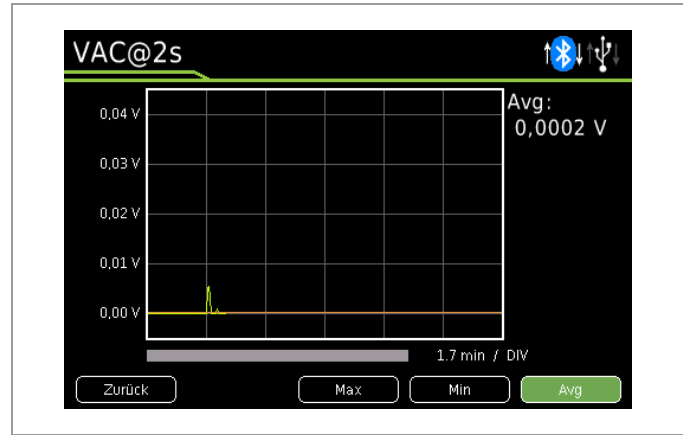

Depending on the chosen selection, the measurement's maximum, minimum or average value is displayed to the right of the diagram.

Key	Meaning
Softkeys	
Back	Returns to the "Cursor" screen, see page 26.
Max	The measurement's maximum value is marked with a cursor and the value is displayed to the right of the diagram. Press again to show or hide the cursor.
Min	The measurement's minimum value is marked with a cursor and the value is displayed to the right of the diagram. Press again to show or hide the cursor.
Avg	The measurement's average value is marked with a cursor and the value is displayed to the right of the diagram. Press again to show or hide the cursor.

8 Measurements

8.1 Enabling Parameter Changes

If password protection has been set up (see section 6.7), the password has to be entered for each of the following measurements in order to change the parameters:

- RISO: Changes to test voltage
- $m\Omega/4$: Changes to test current

As soon as you attempt to change the above mentioned parameters with the help of the Δ/∇ scroll keys, the **Password** menu appears. Enter the current password as described in section 6.7 on page 15.

8.2 Insulation Resistance Measurement – RISO Function (METRAHIT IM XTRA BT and METRAHIT IM E-DRIVE BT only)



Caution: High-Voltage!

Do not touch the conductive ends of the test probes when the instrument has been activated for the measurement of insulation resistance.

You may otherwise be exposed to a current of 2.5 mA (limited in the measuring instrument), and although this is not life endangering, the resulting electrical shock is quite discernible.

If, on the other hand, measurement is being performed on a capacitive device under test, for example a cable, it may be charged with up to approximately ± 1200 V. **Touching the device under test after measurement has been performed is life endangering in this case!**



Attention!

Insulation resistance may only be measured at voltage-free devices!

Interference voltage detection is performed before and during the measurement. If interference voltage U_{ext} of roughly > 15 V AC or > 25 V DC is detected, visual and acoustic warnings are generated. Measurement is also disabled during pre-measurement testing. If interference voltage is detected during measurement, automatic switching to voltage measurement occurs and momentarily measured voltage is displayed as U_{ext} .



Attention!

The measurement cables may not come into contact with each other during high-resistance insulation measurements!



Note

The “RISO” or “COIL” switch position may only be used for insulation resistance measurement and inter-turn short circuit detection.

8.2.1 Preparing for Measurement

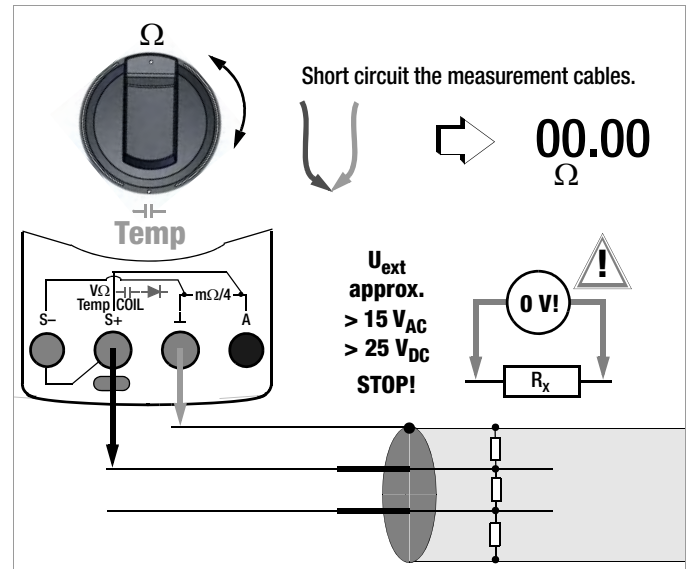

- Check the measurement cables: Short circuit the test probes at the ends of the measurement cables before performing insulation resistance measurements with the selector switch in the Ω position, in order to make sure that a value close to 0Ω is displayed at the instrument. In this way, incorrect connection can be avoided and interrupted measurement cables can be detected.
- Connect the measurement cables to the accessible $M\Omega$ and \perp sockets, using the included probe for connection to the $M\Omega$ socket if possible.
- Set the rotary switch to “RISO” or “COIL”.
- Interference voltage testing (V AC+DC TRMS) is conducted in this switch position.



Attention!

If interference voltage of roughly $U_{ext} > 15$ V AC or > 25 V DC is detected, visual and acoustic warnings are generated. Measurement is disabled as well.

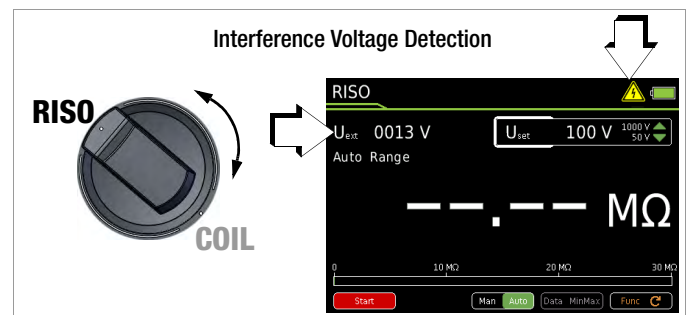

- Select the desired test voltage U_{set} between **50** and **1000 V** with the Δ/∇ scroll keys. It may be necessary to enter a password in order to change test voltage (see section 8.1). The selected test voltage appears at the display during testing.

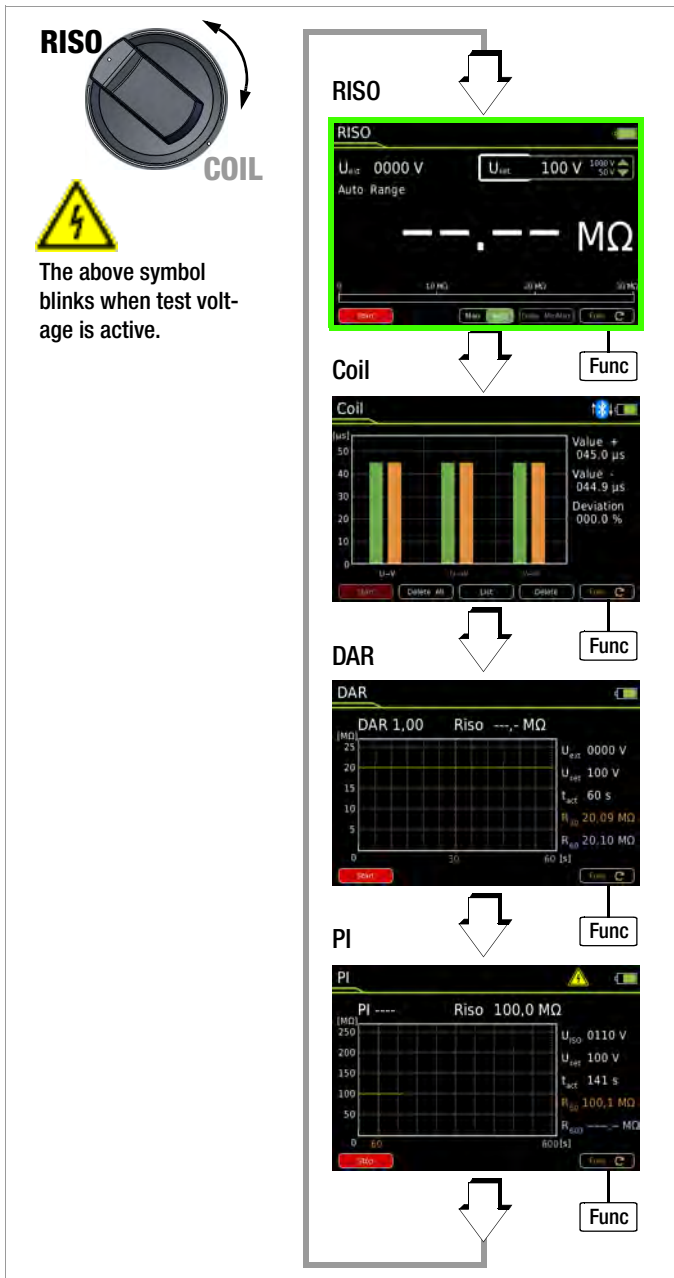

8.2.2 Performing Insulation Measurement

- When the device under test is voltage-free, activate the measurement by pressing, or pressing and holding, the **Start** softkey on the instrument or on the probe. See below for further information.
- Don't read the measurement results until the display has settled in. The high-voltage symbol next to the battery level display blinks during measurement.

Auto-ranging is active during insulation resistance measurement. A DATA function which is matched specifically to the insulation measurement can be activated for automatic retention of valid measured values (see section 7.2.1).

Measurement-Specific Setting: Press and Hold the Start Key

The instrument can be configured such that measurement is activated when the **Start** softkey is pressed or pressed and held, and ended when the key is released.

Either the **Start** softkey on the instrument or the **Start** key on the Z270S probe (METRAHIT IM XTRA BT and METRAHIT IM E-DRIVE BT only) can be pressed and held.



Attention!

Measured value storage is not possible with the **Store** key on the probe if the **Start** key on the probe is pressed and held to activate measurement! If the **Start** key on the probe is pressed and held, pressing the **Store** key on the probe aborts measurement without storing the measured value. Press the **Store** key on the instrument in order to save the measured value. Refer to section 7.6 on page 21 for more information concerning measured value storage and the Z270S probe.

- Press the **MENU** key.
- Press the **Setup for present measurement** softkey.
- Switch to the submenu with the help of the \triangleright scroll key.
- Select the **Hold Start Button** parameter with the Δ / ∇ scroll keys.
- Acknowledge the selected parameter by pressing the **OK** key.
- Select **Yes** or **No** with the help of the Δ / ∇ scroll keys.
- Acknowledge your change with the **OK** key. The entry cursor once again marks the entire parameter line.
- The display is returned to the measuring function by pressing the **ESC** key three times.

MENU \triangleright Setup for Present Measurement Δ / ∇ Hold Start Button \triangleright Δ / ∇ Yes/No

OK
ESC 3x

Automatic Detection of Interference Voltage During Insulation Measurement

If the instrument detects **interference voltage of roughly > 15 V AC or > 25 V DC** (condition: $U_{ext} \neq U_{INS}$, e.g. $R_{iq} < 100 \text{ k}\Omega$ at 100 V, see page 63, footnote 1), the instrument is switched automatically to voltage measurement and the currently measured voltage value is displayed as U_{ext} .



Note

A dead zone results in erroneous measurements for automatic interference voltage detection during insulation measurement. The dead zone lies within a range of 80% to 120% of the selected test voltage (in the case of an interference voltage whose value is equal to that of measuring voltage, the two voltages neutralize each other).

Manual switching to insulation resistance measurement is disabled for as long as voltage is applied to the test terminals.

If interference voltage is no longer present, insulation measurement can be started by pressing the **Start** softkey once again.



Attention!

If "**Error**" appears at the display, the cable (the device under test) is most likely capacitively charged to a significant extent. Remedy: Short circuit the cable (the device under test). Repeat the measurement.

8.2.3 Ending the Measurement and Discharging

- Press the **Stop** softkey in order to end the measurement. If the **Press and Hold the Start Key** setting has been activated, release the **Start** key (see page 28).

A warning is displayed during the discharging procedure which isn't cleared from the display until applied voltage

U_{ext} is 0000 V.

The instrument's internal 1 M Ω resistor causes rapid discharging. Contact between the object and the instrument must not be interrupted.

Do not disconnect the DUT until voltage has fallen below 25 V and the warning has been cleared from the display!

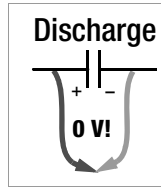

Note

Voltage measurement in the **RISO** or **COIL** switch position is used primarily for interference voltage detection before the respective measurement.

Use the V_{\sim} , V_{\square} or V_{\approx} switch position in order to perform precise voltage measurements.

8.3 Inter-Turn Short Circuit Measurement – COIL Function (METRAHIT IM XTRA BT and METRAHIT IM E-DRIVE only)

In combination with METRAHIT IM XTRA BT and METRAHIT IM E-DRIVE BT multimeters, the COIL TEST ADAPTER (COIL ADAPTER 50mH) and the **COIL ADAPTER XTRA** make it possible to measure inter-turn short circuiting. The adapters are universally suitable for numerous electric motors with various power ratings.



Note

The Z720S probe cannot be used when measuring inter-turn short circuiting with an adapter.



Note

This measurement cannot be performed with the Periodic recording type.
(MENU > General Setup Δ Memory Δ Recording Type).
If switching to this measurement occurs during an ongoing measurement with the Periodic recording type, the measurement is aborted and a corresponding message appears.

8.3.1 Inter-Turn Short Circuit Measurement with the COIL TEST ADAPTER

In combination with the optional COIL TEST ADAPTER, inter-turn short circuit measurements with a test voltage of 1000 V are possible within an inductance range of 10 μ H to 50 mH (100 Hz). This range corresponds to motors in accordance with DIN standards with power ratings of roughly 15 kVA to 80 MVA.

A time value which depends on the inductance of the respective coil is ascertained for each motor coil or coil combination, one after the other, during this measurement with high-voltage. A comparison of the time values makes it possible to check the motor coils for symmetry, and thus to detect an inter-turn short circuit.

8.3.1.1 Preparing for Measurement

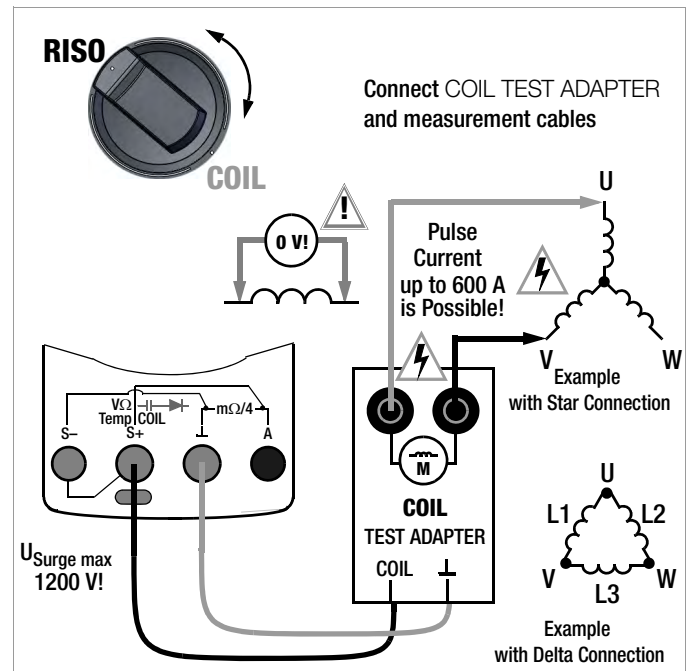

Note

Inter-turn short circuit measurements may only be conducted on voltage-free coils.

- Set the rotary switch to "**RISO**" or "**COIL**".
- Repeatedly press the **Func** softkey until the measurement view for **COIL** appears at the display.
- Select the motor or coil type to be tested under the measurement type parameter in "Setup for present measurement" (see below).

Selecting the Type of Measurement

MENU > Setup for Present Measurement > Parameter ▷ △▽
Measurement Type

OK △▽ Coil / 1-Ph. Motor / 3-Ph. Motor **OK**
ESC 3 × > Measurement View

1-Ph. Motor: AC motor (L1)
3-Ph. Motor: 3-Phase motor (U-V, U-W, V-W)
Coil: Motor with up to 15 coils (L1 - L15)

⇒ Select polarity: unipolar or bipolar (see below).

Polarity Selection

MENU > Setup for Present Measurement > Parameter ▷ △▽
Polarity

OK △▽ Bipolar / Unipolar **OK**
ESC 3 × > Measurement View

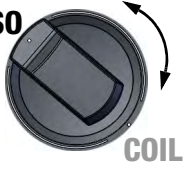
RISO 

Coil 

The above symbol blinks when test voltage is active.

DAR

PI

The diagram illustrates the measurement process flow. It starts with the 'RISO' menu, which shows 'U_{set}: 0000 V' and 'U_{set}: 100 V'. The 'Func' key is used to select 'Coil', leading to a bar graph display. From there, the 'Func' key is used to select 'DAR', leading to a graph showing 'DAR 1,00' and 'Riso ---, - MΩ'. Finally, the 'Func' key is used to select 'PI', leading to a graph showing 'PI ----' and 'Riso 100,0 MΩ'. Arrows indicate the flow between these screens, and 'Func' buttons are shown at each step.

Test Voltage (U_{set} = 1000 V)

Test voltage for the inter-turn short circuit measurement is permanently set to 1000 V and cannot be changed.

Connection and Contacting

⇒ Make sure that the device under test is voltage-free.



Note

Interference voltage cannot be detected in combination with the COIL TEST ADAPTER (COIL ADAPTER 50 mH).

- ⇒ Connect the COIL TEST ADAPTER via the contact protected plug of its connector cable to the two accessible sockets at the multimeter: i.e. the red cable to the **COIL** socket and the black cable to the ⊥ socket.
- ⇒ Connect the two measurement cables to the sockets at the COIL TEST ADAPTER (identified with motor symbol).
- ⇒ If possible, contact the inductive device under test with optional alligator clips plugged onto the test probes. In the case of 3-phase motors, for example, contact coil terminals U-V, V-W and U-W or L1, L2 and L3, one after the other.



Caution: High-Voltage!

Do not touch the conductive ends of the test probes as long as measurement is active and the **Stop** softkey is displayed. A voltage of up to 1200 V is present at the multimeter's two enabled output sockets, and as a pulsed voltage at the two output sockets of the COIL TEST ADAPTER (identified with motor symbol).

Multimeter: You may otherwise be exposed to a current of 2.5 mA (limited in the measuring instrument), and although this is not life endangering, the resulting electrical shock is quite discernible.

COIL TEST ADAPTER: Power pulse currents of up to 600 A can flow from the output sockets.

The device under test can become charged: after each measurement, wait until voltage at the device under test has been discharged (i.e. until the "Discharging ..." message is cleared from the display). Touching the device under test may otherwise be life endangering!



Caution: High-Voltage!

In the case of inter-turn short circuit measurements at transformers, very dangerous high-voltage may occur at the output side depending on the transformation ratio.

Measured Value Displays

Graphic

Graphic representation is used as a standard feature for the measurement view. If the instrument is in the list view, you can switch to the graphic display by pressing the **Graphic** softkey.

Horizontal axis: Coil U-V, U-W or V-W

Vertical axis: Time value in μs

The currently measured time value for the coil selected with the scroll key is digitally displayed in microseconds to the right of the bar graph. As of the second measurement, deviation from the smallest to the largest measured time value is additionally displayed as a percentage.

- ⇒ You can delete each measurement in order to repeat it by selecting the desired axis position for U-V, U-W or V-W with the <|> scroll key and pressing the **Delete** softkey.

List

You can switch to the list view anytime by pressing the **List** softkey. In this case, deviation from the previous time values, as well as date and time of the measurement, are listed along with the respective time values. The final comparison of all measurements appears in the table's header in terms of deviation as a percentage.

- ⇨ You can delete each measurement in order to repeat it by selecting the desired table row for U-V, U-W or V-W with the Δ or ∇ scroll key and pressing the **Delete** softkey.

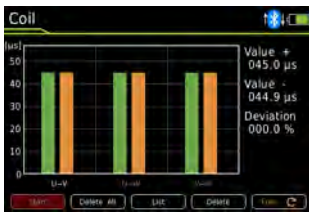

Graphic Representation

Id	Value +	Value -	Value Avg	ΔRef	Date / Time
U-V	044.7 µs	044.6 µs	044.7 µs	000.0 %	02.01.17 03:23
U-W	044.7 µs	044.6 µs	044.7 µs	000.0 %	02.01.17 03:24
V-W	044.7 µs	044.7 µs	044.7 µs	000.0 %	02.01.17 03:24

List View

8.3.1.2 Conducting the Inter-Turn Short Circuit Measurement

- ⇨ Contact the desired coil (e.g. U-V) in order to test for absence of voltage.



Attention!

Perform measurement with self-retaining contacting devices, for example alligator clips. Poor contact may result in sparking and if the contacting element slips off of the device under test, the inspector is exposed to life-threatening danger!

- ⇨ **Activating the Inter-Turn Short Circuit Measurement**
Activate the measurement by pressing the **Start** softkey. The high-voltage symbol next to the battery level display blinks during measurement.
- ⇨ Measurement is stable as soon as a bar graph appears along with the associated time value specified in microseconds to the right of the bar graph and deviation to the previous measurement is displayed as a percentage for the respective coil L.
- ⇨ Measurement is ended automatically. The measurement can be aborted by pressing the **Stop** softkey.*
- ⇨ Before removing the contacting element, allows the coil to discharge via the multimeter (see section 8.3.1.3).
- ⇨ Measurement for motors with three or more coils: Connect the next coil (e.g. V-W) and repeat the measurement procedure described above. The next coil is automatically incremented in the measurement display and activated.

Automatic Evaluation of Measurement Results

Automatic evaluation of measurement results begins when the second measurement is started. The respective measurement view (graph or list view) shows maximum deviation to the previous measurement as a percentage. This permits direct comparison of the first and all subsequent measurements. Due to the fact that the third measurement is then compared with the results of both previous measurements, you automatically get a final comparison of all measurements.

The list view permits a final comparison of all measured motor coils (star or delta connection).

Permissible asymmetry depends on motor type:

A motor with squirrel-cage rotor demonstrates only minimal asymmetry (typically 1%). If deviation is greater than 10%, the device under test is faulty (e.g. inter-turn short circuit).

If any of the time values is 0, there's a short-circuit. If no discharging takes place, the measured coil is interrupted (display: OL).

In order to start a new measurement series, you can:

- Delete the respectively recorded measurement for each coil as described under "Measured Value Displays", or
- Reselect the **COIL** measuring function with the help of the **Func** softkey (or by turning the rotary switch)
- Start a new measurement series by pressing the **Restart** softkey**

* As of firmware version 1.003.000 – in the case of older firmware versions, end measurement by pressing the **Stop** softkey.

In the case of permanent-field motors, inter-turn short circuit measurement is dependent on rotor position. This also applies to squirrel cage motors with large inductances which result in more frequently occurring remanence. In this case, the bipolar setting must be selected for the inter-turn short circuit measurement. First of all, measurement must be performed at each coil with positive polarity. Afterwards, each coil is measured once again with reversed polarity. The connections between the COIL Adapter's terminals and the motor coil are reversed to this end. The instrument generates a mean value based on both measurement results which, to a great extent, is independent of rotor position.

8.3.1.3 Ending the Measurement and Discharging

- ⇨ Measurement is ended automatically. The measurement can be aborted by pressing the **Stop** softkey.***

After measurement has been ended, any remaining residual voltage (U_{ext}) is displayed (message: "Discharging ..."), which may result from cable capacitance. The instrument's internal 1 MΩ resistor causes rapid discharging.

Contact to the motor coils must be retained to this end.

Do not disconnect the DUT until voltage has fallen below 25 V, i.e. until after the "Discharging ..." message has been cleared from the display.

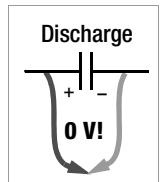

8.3.2 Inter-Turn Short Circuit Measurement with the ADAPTER XTRA****

In combination with the optional COIL ADAPTER XTRA, inter-turn short circuit measurements with a test voltage of 1000 V are possible within an inductance range of 10 µH to 5 H (100 Hz).

Switch set to High: 5 mH to 5 H
Low: 10 µH to 50 mH

This range corresponds to motors in accordance with DIN standards with power ratings of roughly 0.16 kVA to 80 MVA.

Switch set to High: from roughly 0.16 kVA to 160 kVA
Low: from roughly 15 kVA to 80 MVA

A time value which depends on the inductance of the respective coil is ascertained for each motor coil or coil combination, one after the other, during this measurement with high-voltage. A comparison of the time values makes it possible to check the motor coils for symmetry, and thus to detect an inter-turn short circuit.

** As of firmware version 1.003.000.

*** As of firmware version 1.003.000 – in the case of older firmware versions, end measurement by pressing the **Stop** softkey.

**** as of firmware version 1.003.000

8.3.2.1 Preparing for Measurement

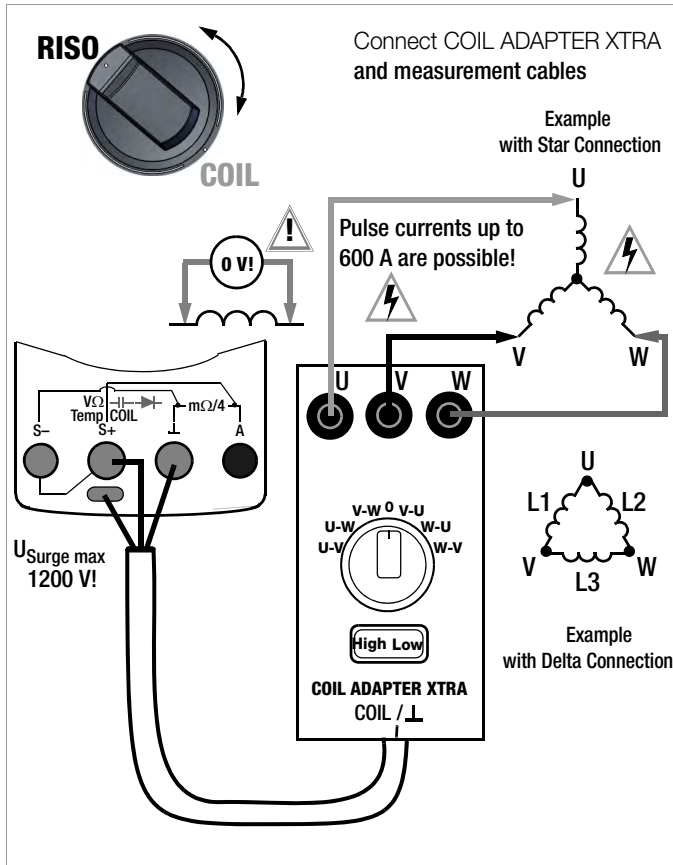

Note
Inter-turn short circuit measurements may only be conducted on voltage-free coils.

- Set the rotary switch to "RISO" or "COIL".
- Repeatedly press the **Func** softkey until the measurement view for **COIL** appears at the display.

Note
After connecting the COIL ADAPTER XTRA to the multi-meter, manual selection of measurement type and polarity is unnecessary (see "Connection and Contacting" on page 33). Measurement type is automatically set to 3-phase motor measurement and polarity is automatically set to bipolar after connection.

- You can view the automatically selected measurement type and polarity mode under "Setup for present measurement".

Viewing the Automatically Selected Measurement Type and Polarity Mode

MENU > Setup for present measurement > Parameters

Measurement type: 3-phase motor (U, V, W)
Polarity mode: Bipolar

Press **ESC** twice > Measurement view

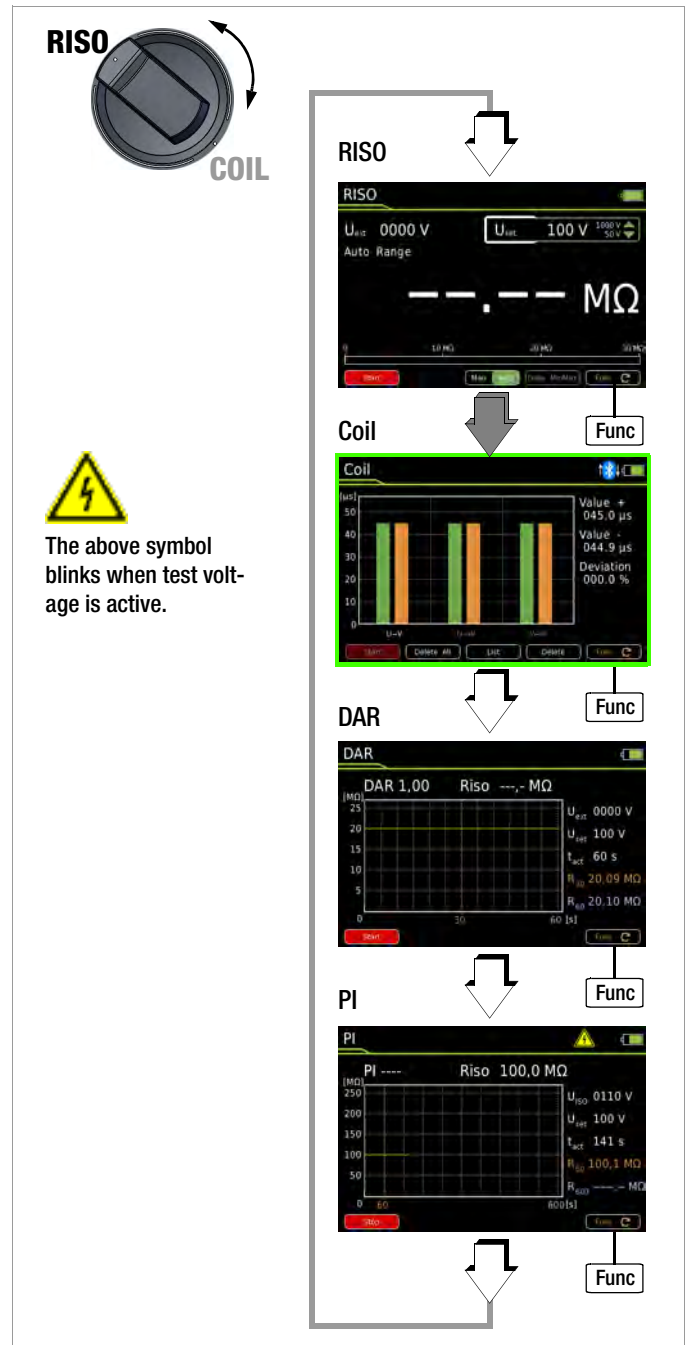

Test Voltage (U_{set} = 1000 V)

Test voltage for the inter-turn short circuit measurement is permanently set to 1000 V and cannot be changed.

Connection and Contacting

- Make sure that the device under test is voltage-free.



Note

In combination with the COIL ADAPTER XTRA, interference voltage can only be detected under certain conditions.

- Connect the COIL ADAPTER XTRA to the **S+** and **⊥** sockets at the multimeter via the contact protected plug.
- Connect the three measurement cables to the sockets labeled **U**, **V** and **W** at the COIL ADAPTER XTRA. In doing so, make sure that the color coding included on the measurement cables and the sockets matches up.
- If possible, contact the inductive device under test with optional alligator clips plugged onto the test probes. Simultaneously contact coil terminals U, V and W, or L1, L2 and L3.



Caution: High-Voltage!

Do not touch the conductive ends of the test probes as long as measurement is active and the **Stop** softkey is displayed.

A voltage of up to 1200 V is present at the multimeter's two enabled output sockets, and as a pulsed voltage at the output sockets of the COIL ADAPTER XTRA (identified with U, V, W).

Multimeter: You may otherwise be exposed to a current of 2.5 mA (limited in the measuring instrument), and although this is not life endangering, the resulting electrical shock is quite discernible.

COIL ADAPTER XTRA: Power pulse currents of up to 600 A can flow from the output sockets.

The device under test can become charged: wait until voltage at the device under test has been discharged after each measurement. The rotary switch may not be turned in order to start the next measurement until after the "Select next switch position at COIL Adapter" prompt appears, which is displayed subsequent to the "Discharging – please wait" message. Touching the device under test may otherwise be life endangering!



Caution: High-Voltage!

In the case of inter-turn short circuit measurements at transformers, very dangerous high-voltage may occur at the output side depending on the transformation ratio.



Caution: High-Voltage!

For safety reasons, all three motor terminals must always be connected to the adapter when measurements are conducted at 3-phase motors. Dangerous voltage may be present at unconnected motor terminals.

Selecting the Inductance Range



Note

The High or Low inductance range is selected with the rocker switch at the COIL ADAPTER XTRA:

High: 5 mH to 5 H (0.16 kVA to 160 kVA)
Low: 10 μH to 50 mH (15 kVA to 80 MVA)

Measured Value Display

Graphic

Graphic representation is used as a standard feature for the measurement view. If the instrument is in the list view, you can switch to the graphic display by pressing the **Graphic** softkey.

Horizontal axis: Coil U-V, U-W, V-W

Vertical axis: Time value in μs
Time value in μs

The currently measured time value for the coil selected at the rotary switch of the COIL Adapter XTRA is digitally displayed in microseconds to the right of the bar graph. As of the second measurement, deviation from the smallest to the largest measured time value is additionally displayed as a percentage.

- Each individual measurement (bar) can be deleted from the graphic in order to repeat it by first of all selecting the desired coil (U-V, U-W, V-W, V-U etc.) with the adapter's rotary switch, and then pressing the **Delete** softkey.

List

You can switch to the list view at any time by pressing the **List** softkey. In this case, deviation from the previous time values, as well as date and time of the measurement, are listed along with the respective time values. The final comparison of all measurements appears in the table's header.

The first line (no. 1) shows the target values for coil U-V/V-U, the second line (no. 2) for coil U-W/W-U and the third line (no. 3) for coil V-W/W-V.

- You can delete the respective measured value pair (for positive and negative polarity) from the list in order to repeat the measurement by first of all selecting the corresponding coil, namely U-V and V-W, U-W and W-U or V-W and W-V, and then pressing the **Delete** softkey.

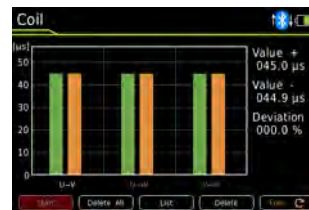

Graphic Representation

Coil					
Deviation 000.0 %					
Id	Value +	Value -	Value Avg	ΔRef	Date / Time
U-V	044.7 μs	044.6 μs	044.7 μs	000.0 %	02.01.17 03:23
U-W	044.7 μs	044.6 μs	044.7 μs	000.0 %	02.01.17 03:24
V-W	044.7 μs	044.7 μs	044.7 μs	000.0 %	02.01.17 03:24

List View

8.3.2.2 Conducting the Inter-Turn Short Circuit Measurement

- Select the desired inductance range (High or Low) with the help of the rocker switch on the adapter (see "Selecting the Inductance Range" on page 33).
- Set the adapter's rotary switch to the desired coil. For example, start with the first switch setting: U-V.
- Contact winding terminals U, V and W or L1, L2 and L3.



Attention!

Perform measurement with self-retaining contacting devices, for example alligator clips. Poor contact may result in sparking and if the contacting element slips off of the device under test, the inspector is exposed to life-threatening danger!

⇨ **Activating the Inter-Turn Short Circuit Measurement**

Activate the measurement by pressing the **Start** softkey. The high-voltage symbol next to the battery level display blinks during measurement.

- ⇨ Measurement is stable as soon as a bar graph appears in the graphic representation along with the associated time value specified in microseconds to the right of the bar graph and deviation to the previous measurement is displayed as a percentage, or the time value and the deviations to the previous measurements are indicated in the respective line in the list view:
U-V, U-W, V-W: green bar in graphic view,
time value for +COIL in list view
V-U, W-U, W-V: orange bar in graphic view,
time value for -COIL in list view
- ⇨ After measurement has been completed, wait until voltage at the device under test has been discharged. The next measurement may not be started until after the “Select next switch position at COIL Adapter” prompt appears, which is displayed subsequent to the “Discharging – please wait” message.



Attention!

Turning the rotary switch or throwing the rocker switch during a running measurement can damage or destroy the COIL ADAPTER XTRA.

- ⇨ Repeat the above described measuring procedure by setting the rotary switch to the corresponding position.
- ⇨ The multimeter detects the selected position and automatically performs the measurement. If measurement is stable, the next measurement results are displayed.
- ⇨ Complete the procedure by conducting measurements, one after the other, for all of the coils or rotary switch positions as described above.

Automatic Evaluation of Measurement Results

Automatic evaluation of measurement results begins when the second measurement is started. The respective measurement view (graphic or list view) shows maximum deviation from the previous measurement as a percentage. This permits direct comparison of the first and all subsequent measurements. Due to the fact that the third measurement is then compared with the results of both previous measurements, you automatically get a final comparison of all three measurements.

The list view permits a final comparison of all measured motor coils (star or delta connection).

Permissible asymmetry depends on motor type:

A motor with squirrel-cage rotor demonstrates only minimal asymmetry (typically 1%). If deviation is greater than 10%, the device under test is faulty (e.g. inter-turn short circuit).

If any of the time values is 0, there's a short-circuit. If no discharging takes place, the measured coil is interrupted (display: OL).

In the case of permanent-field motors, inter-turn short circuit measurement is dependent on rotor position. This also applies to squirrel cage motors with large inductances which result in more frequently occurring remanence. First of all, measurement must be performed at each coil with positive polarity (U-V, U-W, V-W). Afterwards, each coil is measured once again with reversed polarity (V-U, W-U, W-V). The rotary switch on the COIL ADAPTER XTRA must be set to the respective position to this end. As a result, there's no need to reconnect the terminals at the COIL Adapter to the motor coil. The instrument generates a mean value based on both measurement results which, to a great extent, is independent of rotor position.

8.3.2.3 Starting a New Measurement Series / Measuring Routine

In order to start a new measurement series, you can:

- Delete the respectively recorded measurement for each coil as described under “Measured Value Displays”, or
- Reselect the **COIL** measuring function with the help of the **Func** softkey (or by turning the rotary switch)
- Start a new measurement series by pressing the **Restart** softkey

8.3.2.4 Stopping/Ending Measurement and Discharging

You can stop an active measurement (of a coil) at any time, as long as the measurement results have not yet been displayed.

- ⇨ Press the **Stop** softkey.

After measurement has been ended, any remaining residual voltage (U_{ext}) is displayed (message: “Discharging – please wait”), which may result from cable capacitance. The instrument's internal 1 M Ω resistor causes rapid discharging.

Contact to the motor coils must be retained to this end.

Do not disconnect the DUT until voltage has fallen below 25 V, i.e. until after the “Discharging – please wait” message has been cleared from the display.

- ⇨ Press the **Start** softkey in order to restart the measurement.

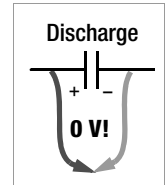

8.3.2.5 Interrupting the Measurement Series / Measuring Routine

- ⇨ The measurement series can be interrupted by setting the rotary switch to the “0” position.
- ⇨ In order to resume the measurement series, set the rotary switch to the desired coil (e.g. V-W) and press the **Start** softkey once again.

8.3.2.6 Saving the Measurement Series

The values obtained during the measurement series can be saved to the instrument's internal memory by pressing the **STORE** key after the measurement series has been completed.

8.4 Absorption Index Measurement – DAR (METRAHIT IM XTRA BT and METRAHIT IM E-DRIVE BT only)



Note

This measurement cannot be performed with the Periodic recording type.
(MENU > General Setup Δ Memory Δ Recording Type).
If switching to this measurement occurs during an ongoing measurement with the Periodic recording type, the measurement is aborted and a corresponding message appears.

The absorption index test is part of the polarization index test (PI). Insulation resistance measurements are placed in relationship to one another after 30 and 60 seconds.

Application: faster version of the polarization index test.

- Set the rotary switch to “RISO”.
- Repeatedly press the **Func** softkey until the measurement view for **DAR** appears at the display.
- Contact the device under test with alligator clips which have been plugged onto the test probes.
- Interference voltage measurement (V AC+DC TRMS) is conducted in this switch position.
- Measurement may only be started when the device under test is voltage-free ($U_{ext} = 0000$ V).
- Activate the measurement by pressing the **Start** softkey. The high-voltage symbol next to the battery level display blinks during measurement.
- You can interrupt the measurement at any time by pressing the **Stop** softkey.

The measurement is recorded and you can observe its progress which is displayed as a curve over the time axis.

Results for R_{30} are displayed after reaching the 30 s mark. Measurement is stopped automatically and results for R_{60} and **DAR** are displayed after reaching the 60 s mark.

The following measured values are displayed digitally next to the graphic representation:

DAR	Absorption index after 60 s
Riso	Momentary measured value in $M\Omega/G\Omega$
U_{ext}	Momentary measuring voltage (actual value)
U_{set}	Test voltage (target value)
t_{act}	Measured time since beginning of measurement
R_{30}	Measured value after 30 s in $M\Omega/G\Omega$
R_{60}	Measured value after 60 s in $M\Omega/G\Omega$

After measurement has been completed, any remaining residual voltage U_{ext} is displayed which may result from cable capacitance and a capacitive device under test. The instrument's internal 1 $M\Omega$ resistor causes rapid discharging.

Contact to the insulation resistance must be retained to this end.

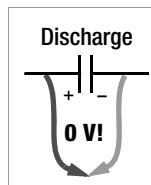

The above symbol blinks when test voltage is active.

8.5 Polarization Index Measurement – PI (METRAHIT IM XTRA BT and METRAHIT IM E-DRIVE BT only)



Note

This measurement cannot be performed with the Periodic recording type.
(MENU > General Setup Δ Memory Δ Recording Type).
If switching to this measurement occurs during an ongoing measurement with the Periodic recording type, the measurement is aborted and a corresponding message appears.

Polarization index testing is recommended for electric machines. This procedure involves expanded testing of insulation resistance R_{ISO} . DC measuring voltage from the multimeter is applied to the insulation for a duration of 10 minutes. The measured R_{ISO} value is documented after one minute, and after ten minutes. If the insulation is good, the value measured after ten minutes is higher than the value measured after one minute. The relationship between the two measured values is the polarization index. Charged material within the insulation is aligned due to the application of measuring voltage over a long period of time, resulting in polarization. The polarization index indicates whether or not the charged material contained in the insulation can still be moved, i.e. whether or not polarization is possible at all. This, in turn, is an indication of the condition of the insulation.

The following rules apply in general:

- PI values < 1: Troubleshooting is required.
- PI values = 1 ... 2 Maintenance is recommended
- PI values = 2 ... 4 DUT is OK,
no immediate action is required
Preventive maintenance can be planned according to workload.
- PI values > 4 DUT in flawless condition

Applications: Determination of moisture and contamination levels

The following applies to the insulation of electric drive units:

- Intact insulation PI ≥ 2
- Very good insulation PI > 4
- Set the rotary switch to "RISO".
- Repeatedly press the **Func** softkey until the PI measurement view appears at the display.
- Contact the device under test with alligator clips which have been plugged onto the test probes.
- Interference voltage measurement (V AC+DC TRMS) is conducted in this switch position.
- Measurement may only be started when the device under test is voltage-free ($U_{ext} = 0000$ V).
- Activate the measurement by pressing the **Start** softkey. The high-voltage symbol next to the battery level display blinks during measurement.
- You can interrupt the measurement at any time by pressing the **Stop** softkey.

The measurement is recorded and you can observe its progress which is displayed as a curve over the time axis.

Results for R_{60} are displayed after reaching the 60 s mark. Measurement is stopped automatically and results for R_{600} and PI are displayed after reaching the 600 s mark.

The following measured values are displayed digitally next to the graphic representation:

- PI Polarization index after 600 s
- Riso Momentary measured value in $M\Omega/G\Omega$

U_{ext}	Momentary measuring voltage (actual value)
U_{set}	Test voltage (target value)
t_{act}	Measured time since beginning of measurement
R_{60}	Measured value after 60 s in $M\Omega/G\Omega$
R_{600}	Measured value after 600 s in $M\Omega/G\Omega$

After measurement has been completed, any remaining residual voltage U_{ext} is displayed which may result from cable capacitance and a capacitive device under test. The instrument's internal 1 $M\Omega$ resistor causes rapid discharging.
Contact to the insulation resistance must be retained to this end.

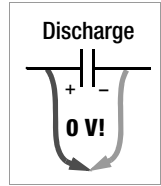

The above symbol blinks when test voltage is active.

Error, “OL“ (overload)

During polarization index testing, insulation resistance R_{ISO} is measured after one and after ten minutes, and the second value must be higher (see beginning of chapter). “OL” (overload) is displayed if the upper range limit is exceeded. In the case of R_{ISO} , the upper range limit is 31,000 digits or 3.1 G Ω . If this value is already exceeded at the beginning of the measurement, a PI value cannot be determined because the second value would have to be higher.

8.6 Voltage Measurement



Warning!

Be aware of the fact that dangerous voltage spikes are not displayed during measurement with the low-pass filter. Measure voltage without the low-pass filter first, in order to be able to detect any dangerous voltages.



Note

Rotary selector switch position “RISO” is available for the detection of interference voltage during insulation resistance measurement. Use switch position V_{\sim} , V_{\equiv} or V_{\approx} in order to perform precise voltage measurements.

8.6.1 Alternating Voltage and Frequency Measurement V AC and Hz with Selectable Low-Pass Filter

- In accordance with the voltage or frequency to be measured, turn the rotary switch to V_{\sim} or Hz.
- Press the **MENU** key.
- Press the “Setup for present measurement” softkey.
- Make sure that the **Clip** parameter is set to **Off**. Otherwise all measured values are displayed in amperes, corrected by the amount resulting from the selected transformation ratio for an interconnected current clamp sensor.
- The display is returned to the measurement view by pressing the **ESC** key twice.
- Repeatedly press the **Func** softkey until the desired measuring function is displayed.
- Connect the measurement cables as shown. The “ \perp ” connector jack should be grounded.

V AC – Voltage Measurement



Note

An intermittent acoustic signal warns the operator if the measured value exceeds the upper range limit in the 1000 V range.

Make sure that a current measuring range (“A”) has not been activated, when the multimeter is connected for voltage measurement! If the fuse’s blowing limits are exceeded as a result of operator error, both the operator and the instrument are in danger!

- You can switch back and forth between voltage measurement with and without low-pass filter.
- Repeatedly press the **Func** softkey until unit of measure **VAC** or **VAC Fil** appears at the display.
- If necessary, conduct zero balancing by pressing the **Zero** key (see section 8.6.4 for description).

Graph Function Expansion

The characteristic curve of this measurement can be displayed with the Graph function expansion (see page 56).

- Press the **Graph** or **DMM** softkey in order to toggle between the graphic display and the measured value display.

Hz – Frequency Measurement

- Connect the measured quantity in the same way as for voltage measurement.
- Manually select the measuring range for the voltage amplitude. When the instrument is switched to frequency measurement, the previously selected voltage measuring range remains active.
- Repeatedly press the **Func** softkey until unit of measure **Hz** appears at the display. Lowest measurable frequencies and maximum allowable voltages are listed in section 10, “Characteristic Values”.

Graph Function Expansion

The characteristic curve of this measurement can be displayed with the Graph function expansion (see page 56).

- ⇨ Press the **Graph** or **DMM** softkey in order to toggle between the graphic display and the measured value display.

VAC Fil – Voltage Measurement with Low-Pass Filter



Attention!

Be aware of the fact that dangerous voltage spikes are not displayed during this type of measurement (see also “Voltage Comparator”).

Measure voltage without the low-pass filter first, in order to be able to detect any dangerous voltages.

A 1 kHz / -3 dB low-pass filter can be activated if required, in order to filter out capacitively induced high frequency pulses of greater than 1 kHz, for example when performing measurements at cables, i.e. undesired voltages of greater than 1 kHz can be suppressed.

Fil appears at the display in order to indicate that the low-pass filter is activated. The multimeter is automatically switched to manual measuring range selection.

Specified measuring accuracy is not reached with signals of greater than 500 Hz when the filter is active.

Graph Function Expansion

The characteristic curve of this measurement can be displayed with the Graph function expansion (see page 56).

- ⇨ Press the **Graph** or **DMM** softkey in order to toggle between the graphic display and the measured value display.



Measuring Ranges:

V: 300 mV/3 V/30 V/

V: 300 V/1000 V

Hz: 300 Hz/3 kHz/

Hz: 30 kHz / 300 kHz

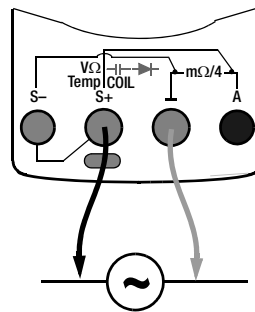

Max. 1000 V 3 kHz

Hz: 1 Hz ... 300 kHz

$P_{max} = 3 \times 10^6 \text{ V} \times \text{Hz}$

V~ & Filter

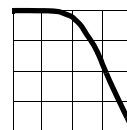

Voltage Comparator for Displaying Dangerous Voltage

The input signal or measuring signal is checked by a voltage comparator for dangerous spikes, because these do not appear at the display when the low-pass filter is used.

At voltages of greater than 15 V AC or 25 V DC, a danger symbol appears at the display: ⚠



Note

The “Setup for present measurement” submenu cannot be accessed for the above described measurements because no further settings are available.

8.6.4 Direct and Pulsating Voltage Measurement, V DC and V (AC+DC)

- ⇨ Set the rotary switch to V_{DC} or $V_{\text{AC+DC}}$.
- ⇨ Press the **MENU** key.
- ⇨ Press the "Setup for present measurement" softkey.
- ⇨ Make sure that the **Clip** parameter is set to **Off**. Otherwise all measured values are displayed in amperes, corrected by the amount resulting from the selected transformation ratio for an interconnected current clamp sensor.
- ⇨ The display is returned to the measurement view by pressing the **ESC** key twice.
- ⇨ Repeatedly press the **Func** softkey until the desired measuring function is displayed.
- ⇨ If necessary, conduct zero balancing by pressing the **Zero** key (see description below).
- ⇨ Connect the measurement cables as shown. The "1" connector jack should be grounded.
- ⇨ Measurement is started immediately.

Note
V (AC+DC) measurement: Due to system design, the DC component displayed in the smallest measuring range (300 mV) has an offset. Select the VDC function for precise measurement of the DC component.

Note
 An intermittent acoustic signal warns the operator if the measured value exceeds the upper range limit in the 1000 V range.

Make sure that a current measuring range ("A") has **not** been activated, when the multimeter is connected for voltage measurement! If the fuse's blowing limits are exceeded as a result of operator error, both the operator and the instrument are in danger!

As soon as the **Man / Auto** key is pressed, and assuming the measured value is less than 280 mV, the multimeter is switched to the mV measuring range.

Graph Function Expansion

The characteristic curve of this measurement can be displayed with the Graph function expansion (see page 56).

- ⇨ Press the **Graph** or **DMM** softkey in order to toggle between the graphic display and the measured value display.

V (AC+DC) Fil – Measurement with Low-Pass filter

Attention!
 Be aware of the fact that dangerous voltage spikes are not displayed during this type of measurement (see also "Voltage Comparator").
 We recommend measuring voltage without the low-pass filter first, in order to be able to detect any dangerous voltages.

A 1 kHz / -3 dB low-pass filter can be activated if required, in order to filter out capacitively induced high frequency pulses of greater than 1 kHz, for example when performing measurements at cables, i.e. undesired voltages of greater than 1 kHz can be suppressed.

Fil appears at the display in order to indicate the respectively activated low-pass filter. The multimeter is automatically switched to manual measuring range selection.

Specified measuring accuracy is not reached with signals of greater than 500 Hz when the filter is active.

Graph Function Expansion

The characteristic curve of this measurement can be displayed with the Graph function expansion (see page 56).

- ⇨ Press the **Graph** or **DMM** softkey in order to toggle between the graphic display and the measured value display.

Measuring Ranges:
 300 mV/3 V/30 V/
 300 V/1000 V

Max. 1000 V 3 kHz
 $P_{\text{max}} = 3 \times 10^6 \text{ V} \times \text{Hz}$

Voltage Comparator for Displaying Dangerous Voltage

The input signal or measuring signal is checked by a voltage comparator for dangerous spikes, because these do not appear at the display when the low-pass filter is used.

At voltages of greater than 15 V AC or 25 V DC, a danger symbol appears at the display: ⚡

Improving Accuracy by means of Zero Balancing – Zero

The currently measured voltage value can be subtracted from future measurements in all voltage measuring ranges.

- ⇨ Press the **Zero** softkey.
- ⇨ The value ascertained for **Zero** is saved and appears above the measurement display. Automatic compensation is implemented for future measurements.
- ⇨ The value for Zero is retained when the instrument is switched to a different measuring function. The correction or offset value is deleted by pressing **Zero** once again, or when the instrument is switched off. The value is cleared from the display.

8.7 Resistance Measurement “Ω”

- ⇨ Disconnect supply power from the electrical circuit of the device to be measured, and discharge all high-voltage capacitors.
- ⇨ Make sure that the device under test is voltage-free. Interference voltages distort measurement results! Refer to section 8.6.4 regarding testing for the absence of voltage with the help of the direct voltage measurement.
- ⇨ Set the rotary switch to “Ω”.
- ⇨ Repeatedly press the **Func** softkey until the “Ω” measuring function is displayed.
- ⇨ If necessary, conduct zero balancing by pressing the **Zero** key (see description below).
- ⇨ Connect the device under test as shown.
- ⇨ Measurement is started immediately.



Note

Use short or shielded measurement cables in the case of high-impedance resistance.

Improving Accuracy by means of Zero Balancing – Zero

Cable resistance and contact resistance can be eliminated in all measuring ranges by means of zero balancing.

- ⇨ Short circuit the measurement cables to this end.
- ⇨ Press the **Zero** softkey.
- ⇨ Insofar as the value for **Zero** is less than a permissible threshold of 0 to 50% of the measuring range, the **Zero** softkey is no longer grayed out in the display and the **Zero** function can be activated by pressing the **Zero** key.
- ⇨ The value ascertained for **Zero** is saved and appears above the measurement display. Automatic compensation of cable resistance is activated for all subsequent measurements.
- ⇨ The value for Zero is retained when the instrument is switched to a different measuring function. The correction or offset value is deleted by pressing **Zero** once again, or when the instrument is switched off. The value is cleared from the display.



Note

The “Setup for present measurement” submenu cannot be accessed for the resistance measurement because no further settings are available.

Graph Function Expansion

The characteristic curve of this measurement can be displayed with the Graph function expansion (see page 56).

- ⇨ Press the **Graph** or **DMM** softkey in order to toggle between the graphic display and the measured value display.

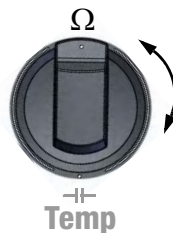

Measuring Ranges:
300 Ω/3 kΩ/30 kΩ/
300 kΩ/3 MΩ/30 MΩ

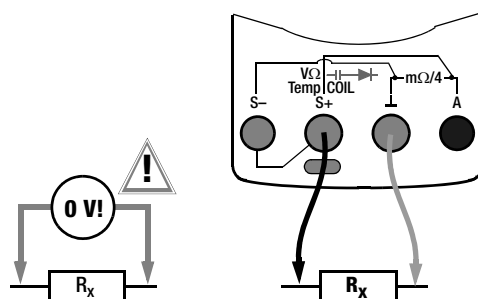
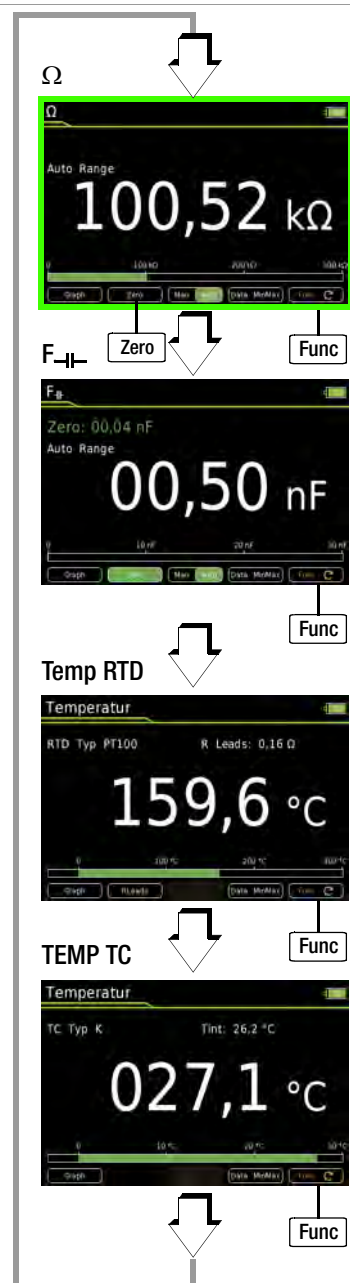

8.8 Capacitance Measurement F-||-

- Disconnect supply power from the electrical circuit of the device to be measured and discharge all high-voltage capacitors.
- Make sure that the device under test is voltage-free. Capacitors must always be discharged before measurement is performed. Interference voltages distort measurement results! Refer to section 8.6.4 regarding testing for the absence of voltage with the help of the direct voltage measurement.
- Set the rotary switch to “ Ω ” or F-||-.
- Repeatedly press the **Func** softkey until the F-||- measuring function is displayed.
- If necessary, conduct zero balancing by pressing the **Zero** key (see description below).
- Connect the (discharged!) device under test to the sockets with the measurement cables as shown.
- Measurement is started immediately.

Improving Accuracy by means of Zero Balancing – Zero

Cable capacitance and junction capacitance can be eliminated in all measuring ranges by means of zero balancing.

- Open the connected measurement cables to this end.
- Press the **Zero** softkey.
- Insofar as the value for **Zero** is less than a permissible threshold of 0 to 50% of the measuring range, the **Zero** softkey is no longer grayed out in the display and the **Zero** function can be activated by pressing the **Zero** key.
- The value ascertained for **Zero** is saved and appears above the measurement display. Automatic compensation of cable capacitance is activated for all subsequent measurements.
- The value for Zero is retained when the instrument is switched to a different measuring function. The correction or offset value is deleted by pressing **Zero** once again, or when the instrument is switched off. The value is cleared from the display.



Note

The “-” pole of polarized capacitors must be connected to the “ \perp ” jack. Resistors and semiconductor paths connected in parallel to the capacitor distort measurement results!



Note

The “Setup for present measurement” submenu cannot be accessed for the capacitance measurement because no further settings are available.

Graph Function Expansion

The characteristic curve of this measurement can be displayed with the Graph function expansion (see page 56).

- Press the **Graph** or **DMM** softkey in order to toggle between the graphic display and the measured value display.

Measuring Ranges:
30 nF/300 nF/
3 μ F/30 μ F/300 μ F

8.9 Temperature Measurement with Resistance Thermometers – Temp RTD

Temperature measurement is performed with a Pt100 or Pt1000 resistance thermometer (accessory, not included), which is connected to the voltage input.

- Set the rotary switch to “Ω” or “Temp”.
- Repeatedly press the **Func** softkey until the **Temp RTD** measuring function is displayed.
- Select the connected temperature sensor (see settings menu below).
- Ascertain offset resistance by pressing the **R Leads** softkey or, if the value is known, enter it to the “Setup for present measurement” submenu (see below). The currently selected value for R Leads appears above the measurement display.
- Connect the sensor to the sockets with the measurement cables as shown.
- Measurement is started immediately. The instrument displays the measured temperature using the selected unit of measure.

Graph Function Expansion

The characteristic curve of this measurement can be displayed with the Graph function expansion (see page 56).

- Press the **Graph** or **DMM** softkey in order to toggle between the graphic display and the measured value display.

Temperature Sensor Selection

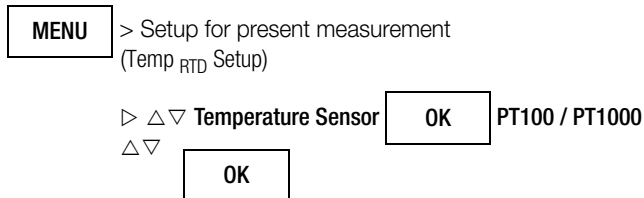

Selecting the Unit of Measure for Temperature

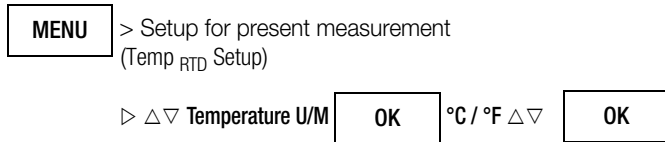

(°C = default setting)

Entering R Leads Offset Resistance

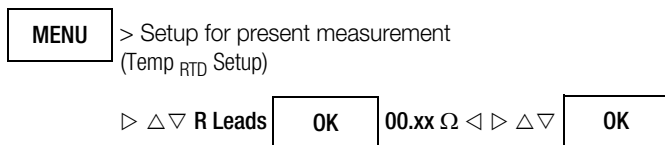

- Enter the known resistance of the connector cables with the scroll keys:
Select the digit to be changed with the ◀ ▶ keys, and change the respectively selected digit with the ▽ Δ keys. The default value is 0.43 Ω. Values can be selected within a range of 0 to 50 Ω.

Ascertaining Cable Resistance – R Leads

- Press the **RLeads** softkey. The “Short circuit cable!” message appears.
- Short circuit the connected measurement cables.
- Store the measured offset resistance value by pressing the **Save** softkey. The ascertained value for R Leads appears above the measurement display. Automatic compensation of

cable resistance is activated for all subsequent measurements. Cable resistance remains in memory even after the instrument has been switched off.

The diagram shows the physical instrument with a rotary switch set to Ω and a Temp button. Below it, a sequence of four screen captures shows the measurement process:

- Ω**: Display shows Zero: 000,11 Ω, Auto Range, and a measurement of 250,03 Ω.
- F-||-**: Display shows Zero: 00,04 nF, Auto Range, and a measurement of 00,50 nF.
- Temp RTD**: Display shows RTD Typ Pt100, R Leads: 0,16 Ω, and a temperature measurement of 159,6 °C.
- TEMP TC**: Display shows TC Typ K, Tint: 26,2 °C, and a temperature measurement of 027,1 °C.

Navigation arrows and softkey labels (Func, RLeads) indicate the sequence of operations between screens.

Measuring Ranges

RTD	Pt 100	-200.0 ... +850.0 °C
RTD	Pt 1000	-150.0 ... +850.0 °C

8.10 Temperature Measurement with Thermocouple – Temp TC

Temperature measurement is performed with a type K thermocouple (accessory, not included), which is connected to the voltage input.

- ⇨ Set the rotary switch to “Ω” or “Temp”.
- ⇨ Repeatedly press the **Func** softkey until the **Temp TC** measuring function is displayed.

The reference temperature is measured via an internal reference junction. It's displayed as TINT, or it can be queried via “General Setup” (see description below).

The “Setup for present measurement” menu can be used to specify whether or not the internal reference junction temperature or a manually entered temperature will be used (see below). If “Manual” temperature is selected, TMAN appears at the display.

- ⇨ Connect the sensor to the sockets with the measurement cables as shown.
- ⇨ Measurement is started immediately. The instrument displays the measured temperature using the selected unit of measure.

Querying the Measured Reference Temperature

MENU > General Setup > Info > **Temperature xx.x °C**



Note

The internal reference temperature (temperature of the internal reference junction) is measured by a temperature sensor inside the instrument. This may be somewhat higher or lower than room temperature as a result of internal heat-up, or moving from warmer to colder surroundings or vice versa.

Selecting the Unit of Measure for Temperature

MENU > Setup for present measurement (Temp TC Setup)
 ▷ Δ∇ Temperature U/M **OK** °C / °F Δ∇ **OK**

(°C = default setting)

Entering a “Manual” Reference Temperature Tman

MENU > Setup for present measurement (Temp TC Setup)
 ▷ Δ∇ Tman **OK** +xx.x °C <Δ∇ **OK**

Choice Between Measured and “Manual” Reference Temperature

MENU > Setup for present measurement (Temp TC Setup)
 ▷ Δ∇ Compensation Type **OK** Man / Int Δ∇
OK

Man Manually specified reference temperature

Int Internally measured reference temperature

Measuring Range

TC	K (NiCr-Ni)	-250.0 ... +1372.0 °C
----	-------------	-----------------------

8.11 Continuity Test Ω

- Disconnect supply power from the electrical circuit of the device to be measured and discharge all high-voltage capacitors.
- Make sure that the device under test is voltage-free. Interference voltages distort measurement results!
- Set the rotary switch to “ Ω ”.
- A loudspeaker symbol appears at the display.
- Select the desired threshold with the $\Delta \nabla$ scroll keys (see description below).
- Connect the conductor path under test as shown.
- Measurement is started immediately.

Adjusting the Threshold

Depending upon the selected threshold, the multimeter generates a continuous acoustic signal in the case of continuity or short-circuiting, i.e. at a value of less than the selected threshold.

“OL” appears at the display in the event of an open connection.

The threshold is adjusted with the $\Delta \nabla$ scroll keys.

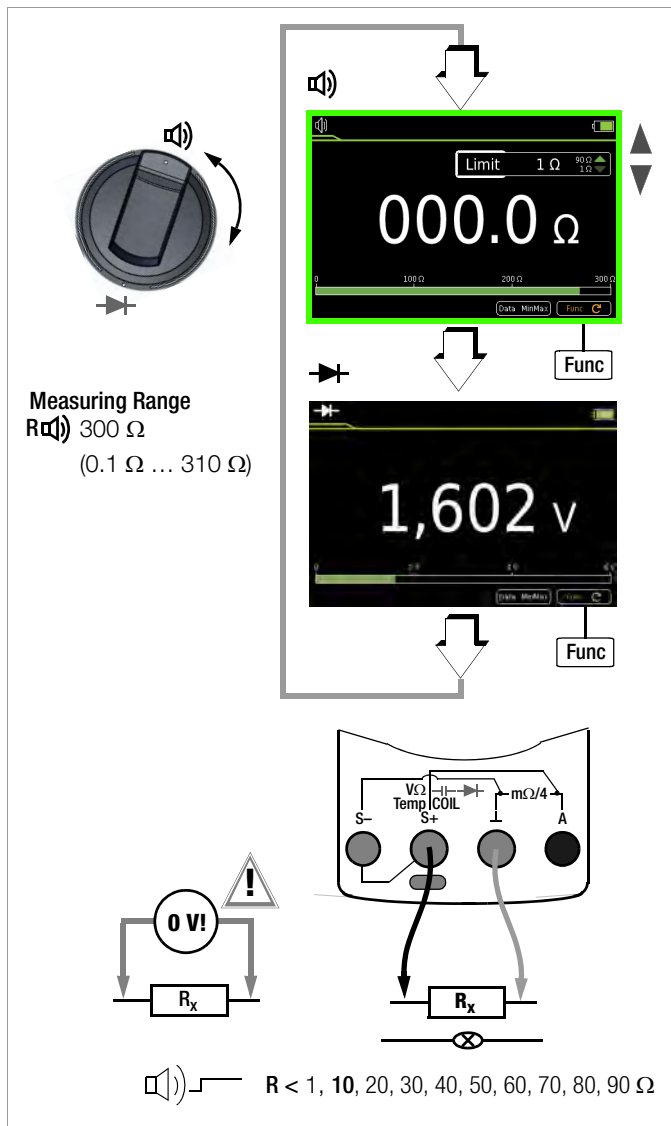

Note

The “Setup for present measurement” submenu cannot be accessed for the continuity test or the diode test.

8.12 Diode Testing \rightarrow with Constant Current of 1 mA

- Disconnect supply power from the electrical circuit of the device to be measured and discharge all high-voltage capacitors.
- Make sure that the device under test is voltage-free. Interference voltages distort measurement results! Refer to section 8.6.4 regarding testing for the absence of voltage with the help of the direct voltage measurement.
- Set the rotary switch to “ Ω ”.
- Press the **Func** key.
- The diode symbol appears at the display.
- Connect the device under test as shown.
- Measurement is started immediately.

Forward Direction and Short-Circuit

The instrument displays forward voltage in volts (display: 4 places). As long as voltage drop does not exceed the maximum display value of 4.5 V, several series connected components or reference diodes with small reference voltages, as well as Zener diodes and LEDs, can be tested.

Reverse Direction and Interruption

The measuring instrument indicates overflow “OL”.



Note

Resistors and semiconductor paths connected in parallel to the diode distort measurement results!

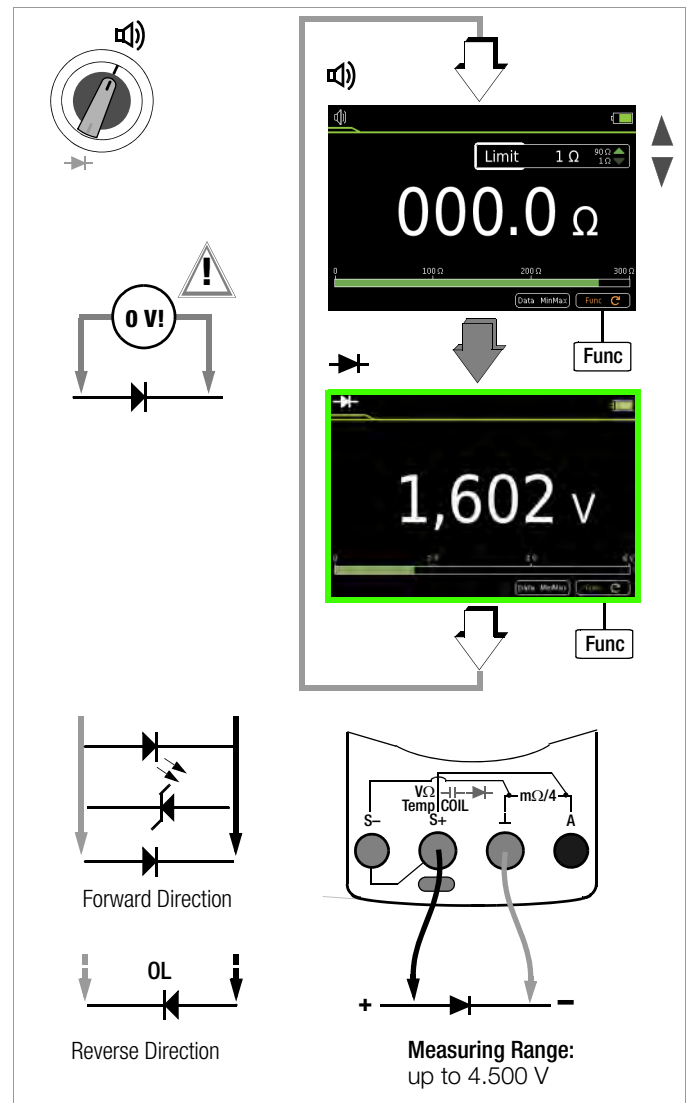

8.13 Milliohm Measurement – Rlo (2-wire measurement) (METRAHIT IM XTRA BT and METRAHIT IM E-DRIVE only)

- Disconnect supply power from the electrical circuit of the device to be measured and discharge all high-voltage capacitors.



Attention!

The device under test must be voltage-free! If interference voltage of $U_{ext} > 2\text{ V}$ is detected, visual and acoustic warnings are generated. Measurement is disabled as well. Refer to section 8.6.4 regarding testing for the absence of voltage with the help of the direct voltage measurement.

- Set the rotary switch to **Rlo**.
- Select desired test current **I_{p set}** with the Δ/∇ scroll keys.
- Select desired test current **I_{p set}** polarity: $\pm/+/-$
- Connect the device under test as shown.
- Activate the measurement by pressing the **Start** softkey on the instrument or on the included probe.
- If necessary, conduct zero balancing by pressing the **Zero** key (see description below).
- Press the **Stop** softkey in order to end the measurement.

Improving Accuracy by means of Zero Balancing – Zero

Cable resistance and contact resistance can be eliminated in all measuring ranges by means of zero balancing.

- Short circuit the measurement cables to this end.
- Activate the measurement by pressing the **Start** softkey.
- Insofar as the value for **Zero** is less than a permissible threshold of 0 to 50% of the measuring range, the **Zero** softkey is no longer grayed out in the display and the **Zero** function can be activated by pressing the **Zero** key.
- The value ascertained for **Zero** is saved and appears above the measurement display. Automatic compensation of cable resistance is activated for all subsequent measurements. Cable resistance is deleted after the measurement has been ended.
- The correction or offset value is deleted by pressing **Zero** once again during measurement, or by ending the measurement. The value is cleared from the display.



Note

The “Setup for present measurement” submenu cannot be accessed for the milliohm measurement because zero balancing and the polarity of test current **I_p** can be selected directly in the measurement view.

Blown Fuse

In the event of a blown fuse, measurement is not possible and the following display appears:

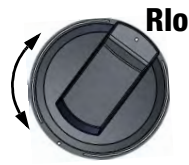
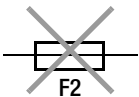

Measuring Ranges:
3 Ω /30 Ω

Test Current:
 $\pm/+/ - 20\text{ mA}$
 $\pm/+/ - 200\text{ mA}$

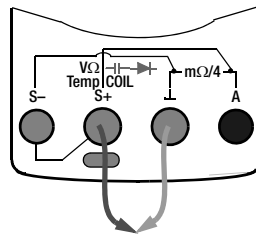
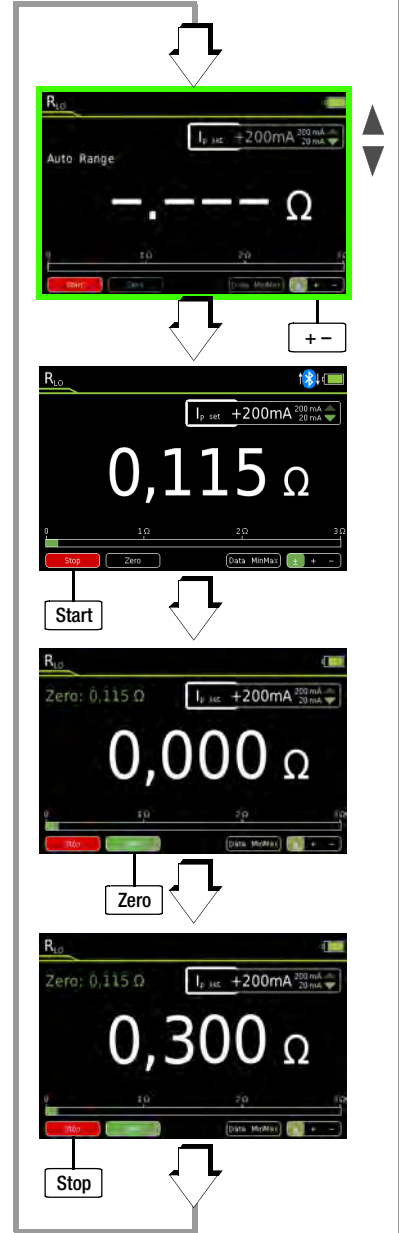

Short circuit the ends of the measurement cables.

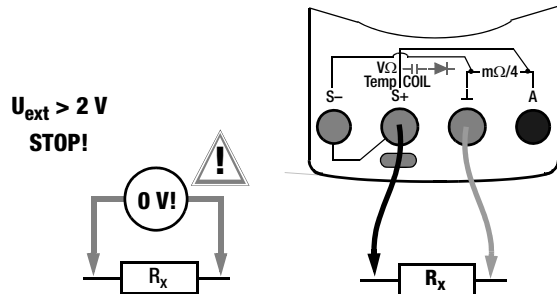

8.14 Milliohm Measurement – $m\Omega/4$ (4-wire measurement)

8.14.1 Compensation of Cable Resistance

Electrical resistance is a dipole which can generally only be measured using two poles. This is accomplished by directing a measuring current of predetermined magnitude through the device under test and measuring the resultant voltage drop. The respective resistance value is derived from the quotient of these two values.

The two points between which voltage is measured are decisive as regards the results of the measurement. All resistances between these two points add to the measured resistance value. These include contact resistance, as well as cable resistance. If a very low resistance value needs to be measured, for example contact resistance at a contactor with a value of only a few milliohms, the points between which voltage is measured must be moved out of the measuring instrument and positioned as closely as possible to the device under test. For this reason, the measuring instrument is equipped with separate jacks for current feed and voltage measurement. This type of 4-pole connection is known as connection according to Kelvin.

KC4 Kelvin clips and KC27 Kelvin probes (available as accessories) allow for simple, correct connection.

Measurement with the KC27 Kelvin Probe

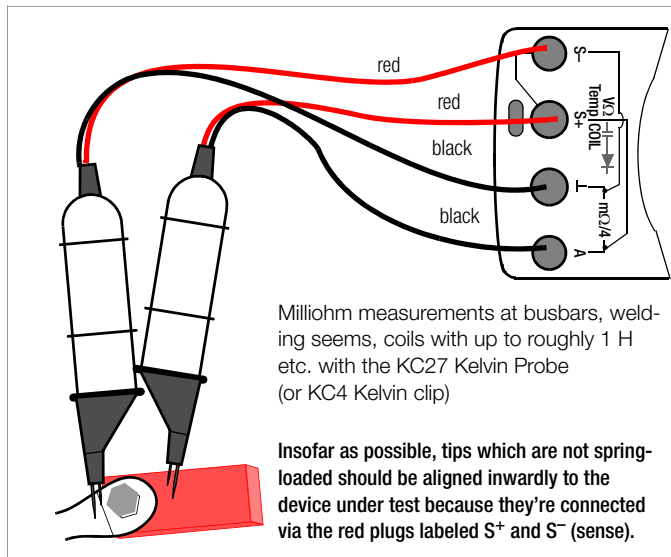

Measurement with KCV100 Cable Reel for 4-Wire Measurement with 200 mA

The KCV100 is a 100-meter, 2-pole extension cord which permits 4-wire 200 mA measurement at large objects, for example bonding tests, testing of lightning protection and wick tests at large objects such as wind power turbine blades and lattice towers.

A Kelvin measuring device is also required, for example the KC27 Kelvin probe.

Measuring Instrument in Direct Proximity to the Inspector

The measuring instrument, including the part of the Kelvin measuring device connected to it, is in direct proximity to the inspector. The cable reel, and the second part of the Kelvin measuring device which is connected to it, are located at a distance from the measuring site.

Example: Aircraft wings and fuselage.

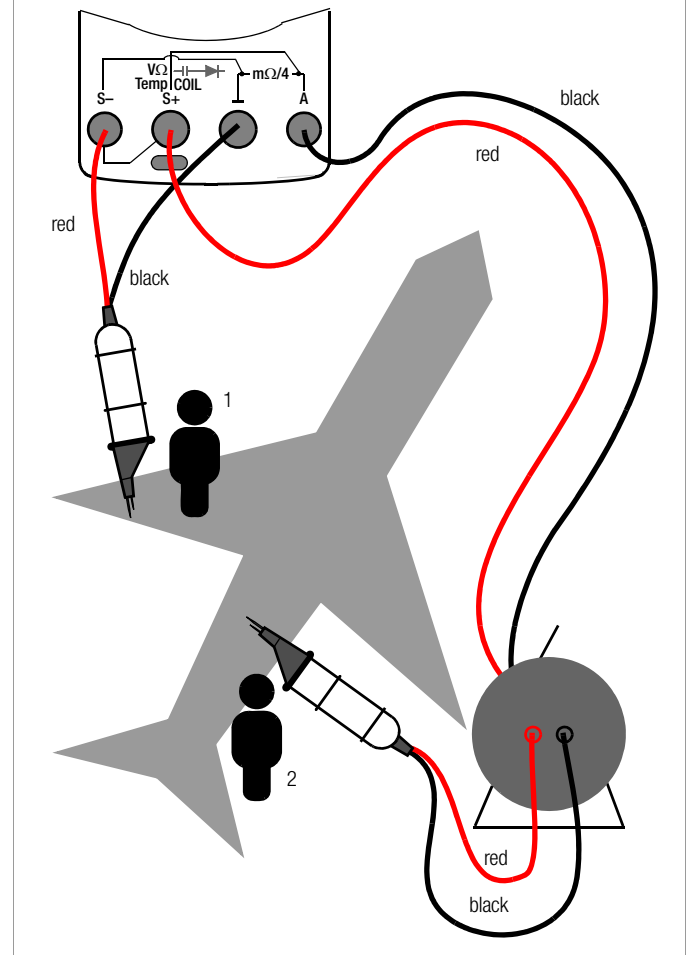

Measuring Instrument at Remote Location

The cable reel and the measuring instrument connected to it (including the part of the Kelvin measuring device connected to the measuring instrument) are located at a distance from the measuring site. Only the second part of the Kelvin measuring device connected to the extension cord is in direct proximity to the inspector.

Example: Wind power turbine.

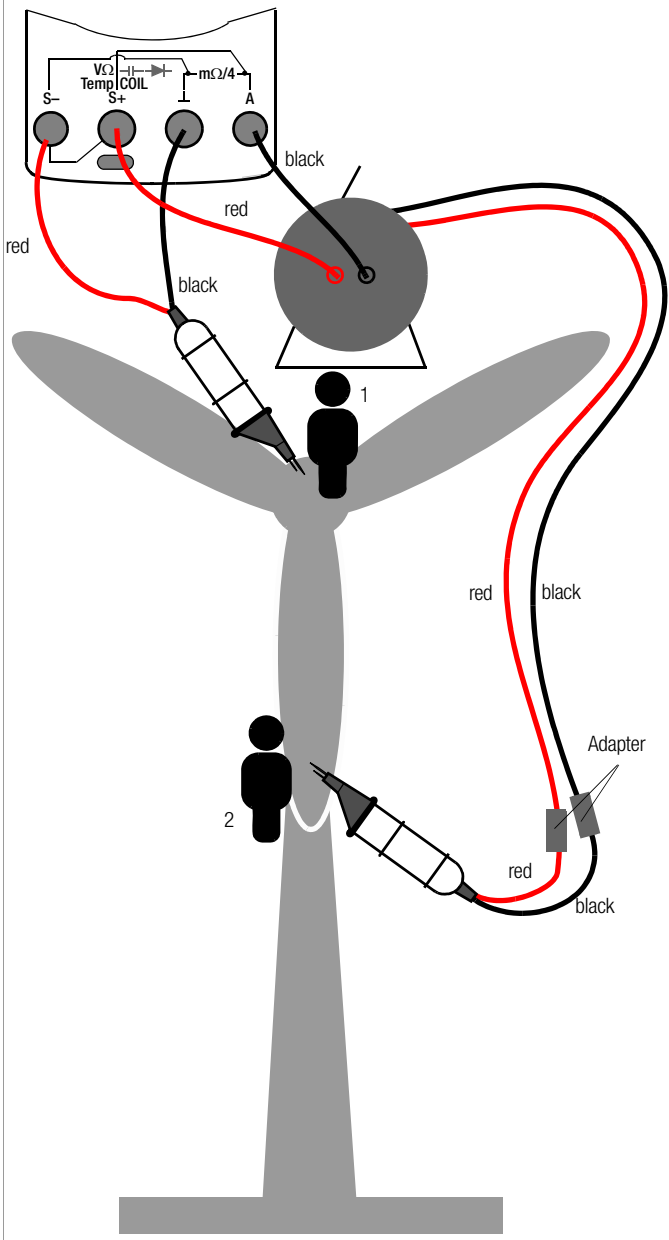

8.14.2 Thermovoltage Compensation

Thermovoltages which occur as a result of material and temperature differences may distort measurement results. For this reason, the instrument is equipped with automatic thermal voltage compensation within the relevant ranges.

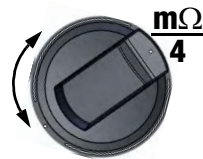

Measuring Ranges:
3 mΩ/30 mΩ/300 mΩ/
3 Ω/ 30 Ω

Test Current:
+20 mA/+200 mA/+1 A

Overall Measuring Range:
mΩ: 0.001 mΩ ... 30 Ω

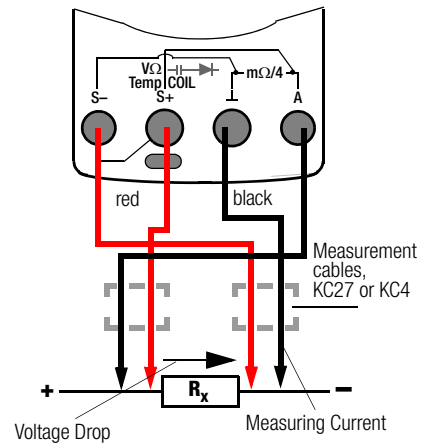
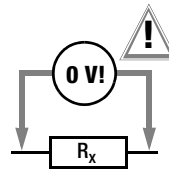

Note:
If KC27 or KC4 is used, the red plug is always connected to S+ or S-.



Note

If measuring current is interrupted during the 4-L-mΩ measurement, or if the fuse blows, the message "LEADS OPEN" appears at the display. Refer to section 11.2 in the event of a blown fuse.

8.14.3 Milliohm Measurement with 200 mA or 20 mA DC [mΩ]

KC4 Kelvin clips and KC27 Kelvin probes (available as accessories) allow for simple, correct connection. The KCV100 accessory cable reel for 4-wire measurement (100 meters) can be used for measurements at large objects (see “Accessories (sensors, plug inserts, adapters, consumable materials)” on page 3).

Resistance at the current jacks should amount to $< 5 \Omega$.

This measuring method is suitable for resistances with inductances of up to 1 H.

- ⇨ Make sure that the device under test is voltage-free (see section 8.6.4). Interference voltages distort measurement results!
- ⇨ Set the rotary switch to “mΩ/4”.
- ⇨ Select desired test current **Ip set** with the $\Delta \nabla$ scroll keys.
- ⇨ If applicable, select the desired measuring range using the **Man / Auto** key: **30 mΩ**, **300 mΩ**, **3 Ω** (Ip set = +200 mA) or **30 Ω** (Ip set = +20 mA).
- ⇨ Connect the device under test as shown. When using accessories, refer to their respective product documentation.
- ⇨ Activate the measurement by pressing the **Start** softkey.
- ⇨ If required, activate thermovoltage correction (see description below).
- ⇨ Press the **Stop** softkey in order to end the measurement.

Thermovoltage Correction in the 30/300 mΩ Range

- ⇨ Connect the measurement cables and press the **TComp** softkey in order to measure thermovoltage.
Wait until the measured value has settled in. This may take several seconds, depending upon inductivity. After the measured value has settled in, press the **Save** softkey. The **TComp** softkey changes color from black to green. All future measurement results will be corrected based upon the previously measured thermovoltage value.
Thermovoltage can also be measured during a running measurement after pressing the **Start** softkey.
Use the same procedure as described above.

Measurements at Inductive Devices

Coils, for example in motors, choke ballasts and contactors, are highly inductive. Changes in current at inductive devices, including those caused by switching the milliohmmeter on and off or changing the measuring range, result in a corresponding voltage change. These changes may be of significant magnitude, and may result in arcing under unfavorable conditions. The milliohmmeter is protected against arcing by means of suitable voltage arrestors.

8.14.4 Milliohm Measurement with 1 A Pulsating Measuring Current (automatic thermovoltage correction at 3 ... 300 mΩ)

- ⇨ Make sure that the device under test is voltage-free (see section 8.6.4). Interference voltages distort measurement results!
- ⇨ Set the rotary switch to “mΩ/4”.
- ⇨ Connect the device under test as shown.

KC4 Kelvin clips and KC27 Kelvin probes (available as accessories) allow for simple, correct connection.

Resistance at the current jacks should amount to $< 0.5 \Omega$.

- ⇨ If applicable, select the desired measuring range using the **Man / Auto** key: **3 mΩ** (Ip set = +1 A), **30 mΩ** or **300 μΩ** (Ip set = +1 A)
- ⇨ Connect the device under test as shown.
Thermovoltage is compensated automatically.
- ⇨ Activate the measurement by pressing the **Start** softkey.
- ⇨ Press the **Stop** softkey in order to end the measurement.

The 1 A setting for test current can be password protected. If applicable, you'll be prompted to enter the valid password (see section 8.1 on page 27).

Thermovoltage Correction in the 30/300 mΩ Range

- ⇨ First press the **Start** softkey and then **TComp** softkey in order to measure thermovoltage. The **TComp** softkey changes color from black to green. Wait until the measured value has settled in. This may take several seconds, depending upon inductivity. Future measurement results will be corrected based on the previously measured thermovoltage value.

8.15 Current Measurement



Attention!

Set up the measuring circuit in a mechanically secure fashion, and secure it against inadvertent breaks. Select conductor cross-sections and lay out connections such that they do not overheat.



Note

In the case of current greater than 1.1 A, "OL" appears at the display.

8.15.1 Direct and Pulsating Current Measurement, Direct Connection, – A DC and A (AC+DC)

- ⇨ First disconnect supply power from the measuring circuit or the power consumer (1), and discharge any capacitors.
- ⇨ Set the rotary switch to A $\overline{=}$ (A $\overline{=}$).
- ⇨ Repeatedly press the **Func** softkey until the desired measuring function is displayed.
- ⇨ If necessary, conduct zero balancing by pressing the **Zero** softkey (see description below).
- ⇨ Safely connect the measuring instrument (without contact resistance) in series to the power consumer (2) as shown.
- ⇨ Switch supply power to the measuring circuit back on (3).
- ⇨ Read the display. Make a note of the measured value if the instrument is not being operated in the memory mode or the transmission mode.
- ⇨ Disconnect supply power from the measuring circuit or the power consumer (1) once again, and discharge any capacitors.
- ⇨ Remove the test probes from the measuring point and return the measuring circuit to its normal condition.

Graph Function Expansion

The characteristic curve of this measurement can be displayed with the Graph function expansion (see page 56).

- ⇨ Press the **Graph** or **DMM** softkey in order to toggle between the graphic display and the measured value display.

Improving Accuracy by means of Zero Balancing – Zero

The momentarily measured current value can be subtracted from future measurements in all measuring ranges.

- ⇨ Press the **Zero** softkey.
- ⇨ The value ascertained for **Zero** is saved and appears above the measurement display. Automatic compensation is implemented for future measurements.
- ⇨ The value for Zero is retained when the instrument is switched to a different measuring function. The correction or offset value is deleted by pressing **Zero** once again, or when the instrument is switched off. The value is cleared from the display.

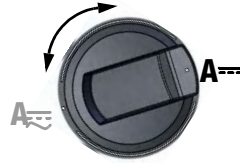

A DC Measuring Range:

A $\overline{=}$: 10 nA ... 1 A

5 ranges:

300 μ A / 3 mA / 30 mA / 300 mA / 1 A

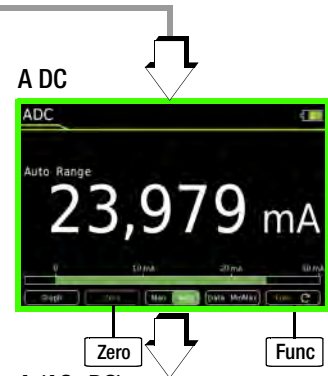

A (AC+DC) Measuring Range:

A $\overline{=}$: 10 nA ... 1 A

5 ranges:

300 μ A / 3 mA / 30 mA / 300 mA / 1 A

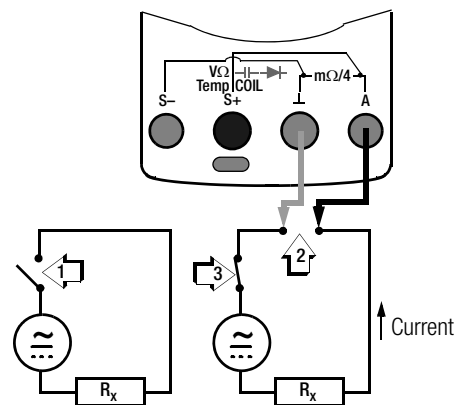
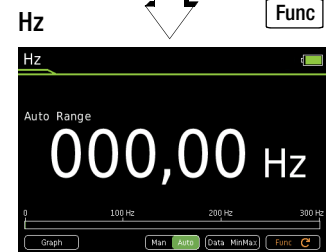

8.15.2 Alternating Current and Frequency Measurement, Direct Connection, – AAC and Hz

- ⇨ First disconnect supply power from the measuring circuit or the power consumer (1), and discharge any capacitors.
- ⇨ Set the rotary switch to A $\overline{=}$ (A $\overline{=}$).
- ⇨ Repeatedly press the **Func** softkey until the desired measuring function is displayed.
- ⇨ If necessary, conduct zero balancing for **AAC** by pressing the **Zero** softkey (see description below).
- ⇨ Safely connect the measuring instrument (without contact resistance) in series to the power consumer as shown.
- ⇨ Switch supply power to the measuring circuit back on (3).
- ⇨ Read the display. Make a note of the measured value if the instrument is not being operated in the memory mode or the transmission mode.
- ⇨ Disconnect supply power from the measuring circuit or the power consumer (1) once again, and discharge any capacitors.
- ⇨ Remove the test probes from the measuring point and return the measuring circuit to its normal condition.

Graph Function Expansion

The characteristic curve of this measurement can be displayed with the Graph function expansion (see page 56).

- ⇨ Press the **Graph** or **DMM** softkey in order to toggle between the graphic display and the measured value display.

Improving Accuracy by means of Zero Balancing – Zero

The momentarily measured current value can be subtracted from future measurements in all measuring ranges.

- ⇨ Press the **Zero** softkey.
- ⇨ The value ascertained for **Zero** is saved and appears above the measurement display. Automatic compensation is implemented for future measurements.
- ⇨ The value for Zero is retained when the instrument is switched to a different measuring function. The correction or offset value is deleted by pressing **Zero** once again, or when the instrument is switched off. The value is cleared from the display.

A AC Measuring Range:
A~: 10 nA ... 1 A

5 ranges:
300 µA / 3 mA / 30 mA / 300 mA / 1 A

Hz Measuring Range:
Hz: 0.01 ... 300 kHz

4 ranges:
300 Hz / 3 kHz / 30 kHz / 300 kHz

8.15.3 Direct and Pulsating Current Measurement with Current Clamp Sensor – ADC und A (AC+DC)

Voltage/Current Transformer Output

When a current clamp sensor is connected to the multimeter (V input), all current displays appear with the correct value in accordance with the selected transformation ratio. The only prerequisite is that the current sensor is equipped with at least one of the below listed transformation ratios, and that the ratio has been previously selected in the following menu (**Clip** ≠ **Off**).

- ⇨ Set the rotary switch to V $\overline{=}$ or V $\overline{\neq}$.
- ⇨ Press the **MENU** key.
- ⇨ Press the “Setup for present measurement” softkey.
- ⇨ Set the **Clip** parameter to the desired transformation ratio (the same ratio as selected at the current clamp sensor) as described below in the current clamp settings menu, or select the desired transformation ratio with the Δ / ∇ scroll keys.
- ⇨ The display is returned to the measurement view by pressing the **ESC** key three times.
- ⇨ Repeatedly press the **Func** softkey until the desired measuring function is displayed.
- ⇨ Connect the current clamp sensor’s measurement cables as shown.
- ⇨ If necessary, conduct zero balancing by pressing the **Zero** key (see description below).

Graph Function Expansion

The characteristic curve of this measurement can be displayed with the Graph function expansion (see page 56).

- ⇨ Press the **Graph** or **DMM** softkey in order to toggle between the graphic display and the measured value display.

Current Clamp Setup Menu

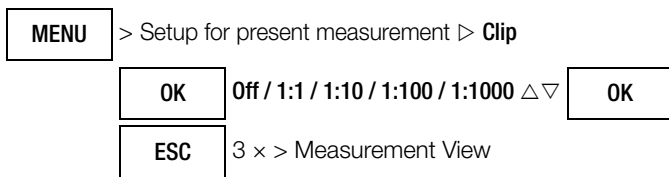

Transformation Ratio	Measuring Ranges		Clamp Type
	300 mV	3 V	
1:1 1m V/1 mA	300.0 mA	3.000 A	
1:10 1m V/10 mA	3.000 A	30.00 A	CP30
1:100 1m V/100 mA	30.00 A	300.0 A	CP330/1100/1800
1:1000 1 mV/1 A	300.0 A	3,000 kA	CP330/1100/1800

The maximum allowable operating voltage is equal to the nominal voltage of the current transformer. When reading the measured value, additional error resulting from the current clamp sensor must also be taken into consideration

(default setting: **Clip** = **Off** = voltage display).

Improving Accuracy by means of Zero Balancing – Zero

The momentarily measured current value can be subtracted from future measurements in all measuring ranges.

- ⇨ Press the **Zero** softkey.
- ⇨ The value ascertained for **Zero** is saved and appears above the measurement display. Automatic compensation is implemented for future measurements.
- ⇨ The correction or offset value is deleted by pressing **Zero**, by changing to another measuring function or by switching the instrument off. The value is cleared from the display.

The top part shows the physical current clamp sensor with a rotary switch set to V $\overline{=}$ or V $\overline{\neq}$ and the text "Clip ≠ Off".

The middle part shows two screenshots of the multimeter display. The top screenshot is for "A DC" and the bottom for "A (AC+DC)". Both show "000.0 mA" and a "Clip" parameter set to "1:1". Arrows indicate the "Zero" and "Func" softkeys on the device.

The bottom part is a circuit diagram for zero balancing. It shows a current transformer with a primary winding (mΩ/4) and a secondary winding (V Ω Temp/COIL). The secondary is connected to a multimeter input. A resistor R_i (9 MΩ) is connected between the transformer's secondary and the multimeter's input. The primary is connected to a circuit with a resistor R_x and a current source.

8.15.4 Alternating Current Measurement with Current Clamp Sensor – AAC and Hz

Voltage/Current Transformer Output

When a current clamp sensor is connected to the multimeter (V input), all current displays appear with the correct value in accordance with the selected transformation ratio. The only prerequisite is that the current sensor is equipped with at least one of the below listed transformation ratios, and that the ratio has been previously selected in the following menu (**Clip** ≠ **Off**).

- Set the rotary switch to V~ or Hz.
- Press the **MENU** key.
- Press the “Setup for present measurement” softkey.
- Set the **Clip** parameter to the desired transformation ratio (the same ratio as selected at the current clamp sensor) as described below in the current clamp settings menu, or select the desired transformation ratio with the $\Delta \nabla$ scroll keys.
- The display is returned to the measurement view by pressing the **ESC** key three times.
- Repeatedly press the **Func** softkey until the desired measuring function is displayed.
- Connect the current clamp sensor’s measurement cables as shown.
- If necessary, conduct zero balancing by pressing the **Zero** key (see description below).

Graph Function Expansion

The characteristic curve of this measurement can be displayed with the Graph function expansion (see page 56).

- Press the **Graph** or **DMM** softkey in order to toggle between the graphic display and the measured value display.

Current Clamp Setup Menu

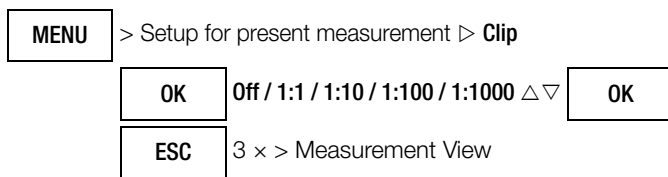

Transformation Ratio	Measuring Ranges		Clamp Type
	300 mV	3 V	
1:1 1m V/1 mA	300.0 mA	3.000 A	METRAFLEX 300M WZ12C, Z3512A
1:10 AM 1m V/10 mA	3.000 A	30.00 A	CP30, METRAFLEX 3000/300M WZ11B, WZ12B, Z3512A
1:100 1m V/100 mA	30.00 A	300.0 A	CP330/1100/1800 METRAFLEX 3000/300M, WZ11B, Z3512A
1:1000 1m V/1 A	300.0 A	3,000 kA	CP330/1100/1800 METRAFLEX 3000, WZ12C, Z3512A

The maximum allowable operating voltage is equal to the nominal voltage of the current transformer. When reading the measured value, additional error resulting from the current clamp sensor must also be taken into consideration (default setting: **Clip** = **Off** = voltage display).

Improving Accuracy by means of Zero Balancing – Zero

The momentarily measured current value can be subtracted from future measurements in all measuring ranges.

- Press the **Zero** softkey.
- The value ascertained for **Zero** is saved and appears above the measurement display. Automatic compensation is implemented for future measurements.

- The correction or offset value is deleted by pressing **Zero**, by changing to another measuring function or by switching the instrument off. The value is cleared from the display.

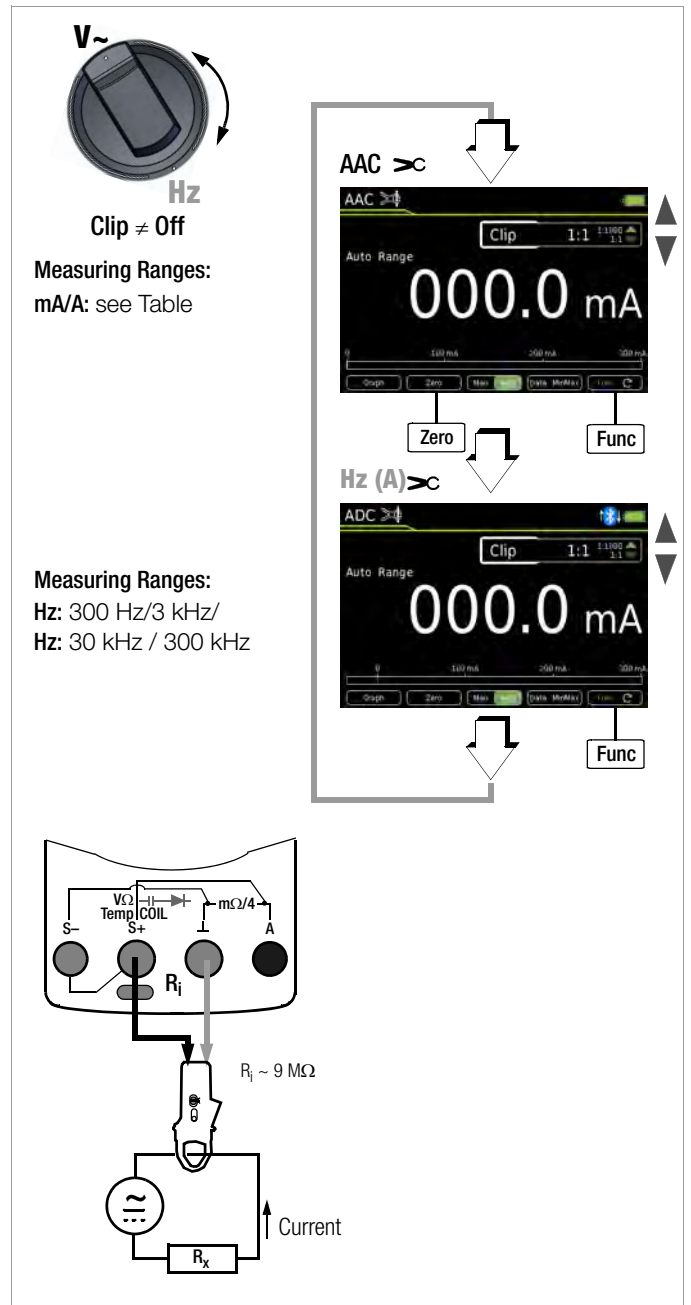

8.16 Measuring Sequences – Test Sequences

If the same sequence of single measurements will be run frequently (one after the other with subsequent report generation), it's advisable to make use of measuring sequences (also called test sequences).

One sequence with up to 10 measurement steps can be created in the METRAHIT IM XTRA and the METRAHIT IM E-DRIVE. The measuring steps can include measuring functions as well as measuring instructions. The number of test sequences can be increased to 16 with up to 63 measuring steps (firmware 1.003.000) for the METRAHIT IM XTRA and METRAHIT IM E-DRIVE with the help of the **Sequence Functions Expert** functions expansion.

The METRAHIT IM TECH BT does not include a measuring sequence function, but can also be equipped with 16 test sequences with up to 63 measuring steps by means of the above-mentioned functions expansion.

Information concerning installation of the functions expansion can be found in section 6.9 on page 16.

Automatic test sequences can be conducted in all rotary switch positions except for **OFF**.



Note

Test sequences can be managed in the instrument, which is described in this section. However, we recommend using convenient **Sequence Manager** software (see section 9.3.4 on page 59).

Creating a New Test Sequence

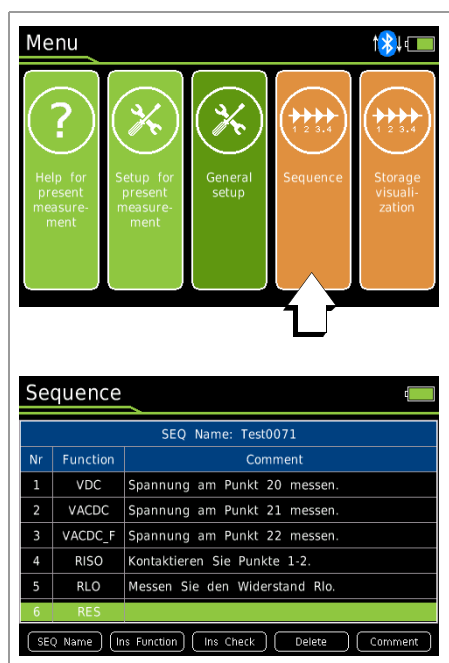

- Select any rotary switch position other than “OFF”.
- Press the **MENU** key.
- Press the **Sequence** softkey. The sequences are displayed.
- First of all assign a name to the sequence to be created. Press the **New** softkey to this end.
- Enter a name using the keyboard which appears at the display as described in page 14.
- Acknowledge your entry by pressing the **ENTER** softkey. The sequences are displayed again.
- Select the new sequence with the $\Delta \nabla$ scroll keys and acknowledge by pressing the **Edit** softkey.
- You can insert a measurement step with any desired measuring function after pressing the **Ins Function** softkey: Press the **Ins Function** key, select the desired function with the rotary switch and acknowledge your selection by pressing the **STORE** key.

The **Information > Sequence design > Press Store key to adopt function** window is displayed once every 5 seconds for a duration of 1 second.

- If you want to insert a manual test step, for example a visual inspection, press the **Ins Check** softkey.
- If you would like to insert a comment, press the **Ins Text** softkey.
- You can enter a comment for each measurement step (function, check or text), which appears at the display during the measuring sequence, for example “measure voltage at point XY”. Press the **Comment** softkey to this end. Enter a text using the keyboard which appears at the display as described in page 14. Acknowledge your entry by pressing the **Enter** softkey. The sequence's steps are displayed once again.
- Individual measurement steps can be removed by selecting the desired step with the cursor and then pressing the **Delete** softkey.

Editing Test Sequences

- Select any rotary switch position other than “OFF”.
- Press the **MENU** key.
- Press the **Sequence** softkey. The sequences are displayed.
- Select the test sequence to be edited with the $\Delta \nabla$ scroll keys.
- Press the **Edit** softkey. The test sequence is displayed.
- You can insert a measurement step with any desired measuring function after pressing the **Ins Function** softkey: Press the **Ins Function** key, select the desired function with the rotary switch and acknowledge your selection by pressing the **STORE** key. The **Information > Sequence design > Press Store key to adopt function** window is displayed once every 5 seconds for a duration of 1 second.
- If you want to insert a manual test step, for example a visual inspection, press the **Ins Check** softkey.
- If you would like to insert a comment, press the **Text** softkey.
- You can enter a comment for each measurement step (function, check or text), which appears at the display during the measuring sequence, for example “measure voltage at point XY”. Press the **Comment** softkey to this end. Enter a text using the keyboard which appears at the display as described in page 14. Acknowledge your entry by pressing the **Enter** softkey. The sequence's steps are displayed once again.
- Individual measurement steps can be removed by selecting the desired step with the cursor and then pressing the **Delete** softkey.

Renaming a Test Sequence

- Select any rotary switch position other than “OFF”.
- Press the **MENU** key.
- Press the **Sequence** softkey. The sequences are displayed.
- Select the test sequence to be edited with the $\Delta \nabla$ scroll keys.
- Press the **Rename** softkey.
- Change the name using the keyboard which appears at the display as described in page 14.
- Acknowledge your entry with the **ENTER** softkey. The name is changed.

Deleting a Test Sequence

- ⇨ Select any rotary switch position other than “OFF”.
- ⇨ Press the **MENU** key.
- ⇨ Press the **Sequence** softkey. The sequences are displayed.
- ⇨ Select the test sequence to be deleted with the Δ/∇ scroll keys.
- ⇨ Press the **Delete** softkey.
- ⇨ Acknowledge the security prompt.
- ⇨ The sequence is deleted.

Specifying Measured Value Storage for Sequences

Measured values can be saved in different ways when running a sequence (see below):

- Automatic:
The value is saved by pressing the **STORE** key and the next sequence step is started automatically.
 - Manual:
The value is saved by pressing the **STORE** key. The next sequence step isn't started until the **OK** key is pressed.
- ⇨ Select any rotary switch position other than “OFF”.
 - ⇨ Press the **MENU** key.
 - ⇨ Press the **General Setup** softkey.
 - ⇨ Select the **Sequence** parameter with the help of the Δ/∇ scroll keys.
 - ⇨ Switch to the submenu with the help of the \triangleright scroll key.
 - ⇨ Select the **Data Storage** parameter with the help of the Δ/∇ scroll keys.
 - ⇨ Acknowledge by pressing the **OK** key.
 - ⇨ Select the desired setting with the Δ/∇ scroll keys.
 - ⇨ Press the **OK** key.
 - ⇨ Return to the main menu by pressing the **ESC** key or the **MENU** key.
 - ⇨ The instrument is returned to the measuring mode after pressing the **ESC** key once more.

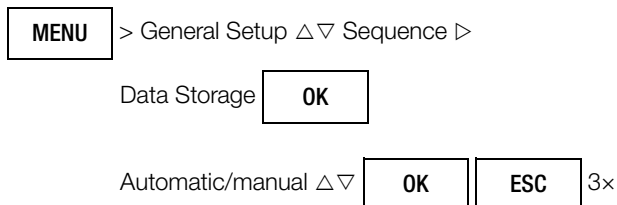

Running a Test Sequence

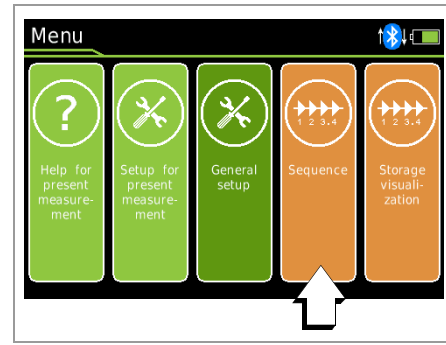

- ⇨ Select any rotary switch position other than “OFF”.
- ⇨ Press the **MENU** key.
- ⇨ Press the **Sequence** softkey.
- ⇨ Select the test sequence to be started with the Δ/∇ scroll keys.
- ⇨ Press the **Start** softkey.
General information concerning the sequence is displayed at first:
STORE: Press the **STORE** key at the multimeter or on the Z270S probe (METRAHIT IM XTRA BT and METRAHIT IM E-DRIVE BT only) at the end of a measurement step in order to save one or more measured values, and the next step is started automatically.



Note

If **Menu > General Setup > Sequence > Data Storage Manual** has been selected, the measured value is saved but the sequence doesn't jump to the next measurement step automatically. In this case, additionally press the **OK** key to start the next step (see “Specifying Measured Value Storage for Sequences” on page 55).

ESC: The sequence can be interrupted by pressing the **ESC** key. Values saved up to this point in time are stored under a name.

- ⇨ Press the **Start** softkey with red background.
- ⇨ A warning appears prompting you to select the rotary switch position which is required for the respective measuring function.
- ⇨ Information concerning the pending measurement step is displayed first of all: Sequence step 1/x: measuring function XY and measuring instructions if applicable.
- ⇨ Acknowledge this information by pressing the **OK** softkey with green background.
- ⇨ The active sequence is displayed in the status bar by means of the **SEQ** symbol.
- ⇨ The respective measuring function is started automatically if a voltage measurement is involved. For other measuring functions, the **Start** softkey for the respective measuring function must first be pressed, and subsequently the **Stop** softkey.
- ⇨ Press the **OK** key in order to save the measured value. The next measurement step is then started.
- ⇨ If the last measurement step of the measuring sequence is ended by pressing the **OK** key, the first four measurement steps or measuring functions are displayed and stored with value, date and time. Press the ∇ scroll key in order to display further measurement steps.
- ⇨ The measuring sequence is ended by pressing the **STORE** key. A corresponding message appears.

Overview of the Meanings of Softkeys and Hard Keys

Key	Function
Softkeys	
New	Create a new test sequence
Rename	Change the name of the test sequence
Ins. text	Enter text above the selected line*
Ins. Function	Insert a measurement step with a measuring function above the selected line
Ins. Check	Insert a measurement step with a measuring instruction above the selected line
Delete	Delete a measurement step which has been previously selected with the cursor or delete a sequence which has been previously selected with the cursor
Comment	Enter a comment for the selected measurement step*
Start	Start the measuring sequence Start the measurement
Pause	Temporarily suspend the measurement Temporarily suspend the measuring sequence
Terminate	Abort the measurement Abort the measuring sequence
OK	Softkey: acknowledge instructions in the measuring sequence
Hard Keys	
△▽	Sequence creation: select measurement step (1 to 10)
STORE	Sequence creation: transfer the measuring function to the sequence, Sequence run: save the measured value for the current measurement step by pressing the hard key at the multimeter or on the Z270S probe (METRAHIT IM XTRA BT and METRAHIT IM E-DRIVE BT only).
OK	Sequence run: end the measurement step.

* See page 14 for a description of keyboard operation for entering text.

8.17 Graph Function Expansion

The characteristic measurement curve can be displayed with the Graph function expansion for the following measurements:

- V AC – Voltage Measurement, see page 37
- Hz – Frequency Measurement, see page 37
- V (AC+DC) Fil – Measurement with Low-Pass filter, see page 38
- Direct and Pulsating Voltage Measurement, V DC and V (AC+DC), see page 40
- VAC Fil – Voltage Measurement with Low-Pass Filter, see page 38
- Resistance Measurement “Ω”, see page 41
- Capacitance Measurement F, see page 42
- Temperature Measurement with Resistance Thermometers – Temp RTD, see page 43
- Temperature Measurement with Thermocouple – Temp TC, see page 44
- Direct and Pulsating Current Measurement, Direct Connection, – A DC and A (AC+DC), see page 50
- Alternating Current and Frequency Measurement, Direct Connection, – AAC and Hz, see page 51
- Direct and Pulsating Current Measurement with Current Clamp Sensor – ADC und A (AC+DC), see page 52
- Alternating Current Measurement with Current Clamp Sensor – AAC and Hz, see page 53

Press the **Graph** softkey to display the characteristic measurement curve in a diagram for the measurements listed above.

Sample Display

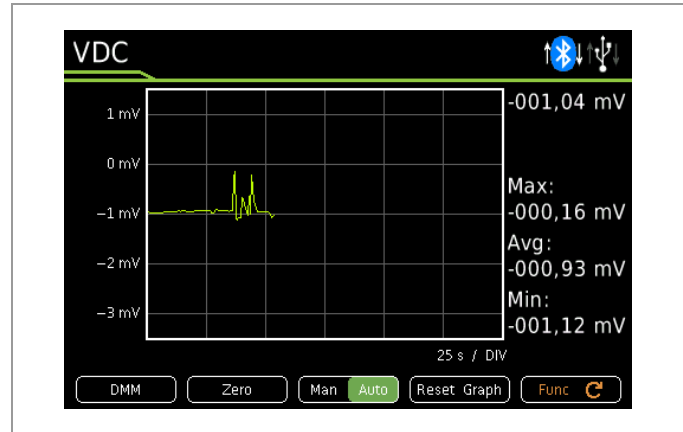

The type of measurement is displayed in the header.

The following is displayed to the right of the diagram from top to bottom:

- Momentary measured value,
- Maximum measured value thus far,
- The measurement's average value thus far
- Minimum measured value thus far.

The time scale is displayed underneath the diagram.

Key	Meaning
Softkeys	
Graph/DMM	Toggle between graphic display and measured value display.
Zero	Activate/deactivate zero balancing.
Man Auto	Toggle between manual and automatic measuring range selection.
Reset Graph	The display is reset.
Func	Toggle amongst the functions of a given rotary switch position.
Hard Keys	
◀▶	Change the measuring range if manual selection is active (see Man Auto softkey).

Demo Mode

Even if the Graph function expansion isn't activated, it can be used 20 times in demo mode. Expiration of free use is indicated by a message.

9 Interface Operation and Software

The multimeters are equipped with a Bluetooth® interface by means of which they can establish connection to a PC, a smartphone (Android™) or a tablet (Android™).

The instruments can be additionally equipped with a USB port via the optionally available USB mains module (see “Accessories (sensors, plug inserts, adapters, consumable materials)” on page 3). Not only can the instrument be supplied with electrical power via the USB port (see section 5.2 on page 12), it can also be connected to a PC.

Bluetooth® and USB connections are independent of each other and can be used simultaneously.

9.1 Bluetooth®

The receiving device must be equipped with Bluetooth® functionality or be connected to a Bluetooth® adapter with the following minimum technical requirements: Bluetooth 4.2 + EDR, class 2.

The following Bluetooth® adapters for communication between the METRAHIT IM XTRA BT / METRAHIT IM E-DRIVE BT and the PC have already been successfully tested: Belkin F8T016NG, LOGI LINK BT0007 and SITECOM CN-524 V2 001.

Activating and Deactivating the Interface



Note

Bluetooth® remains (de)activated even after the instrument has been switched on/off.

- Press the **MENU** key.
- Press the **General Setup** softkey.
- Select the **Interface** menu with the $\Delta\nabla$ scroll keys.
- Switch to the submenu with the help of the \triangleright scroll key.
- Select the **Bluetooth** parameter with the help of the $\Delta\nabla$ scroll keys.
- Acknowledge the selected parameter by pressing the **OK** key.
- Change the Selection “ON, OFF” with the $\Delta\nabla$ scroll keys.
- Acknowledge your change with the **OK** key.

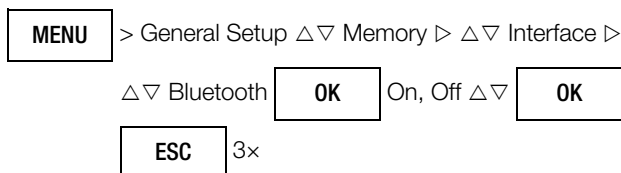

Configuring Interface Parameters

A PIN is used to protect the Bluetooth® connection. The PIN has to be entered to the remote terminal when connection is established.

Default PIN = 1234



Note

We recommend the use of an individualized PIN in order to assure that no third parties can gain access to your instruments.

- Press the **MENU** key.
- Press the **General Setup** softkey.
- Select the **Interface** menu with the $\Delta\nabla$ scroll keys.
- Switch to the submenu with the help of the \triangleright scroll key.
- Select the **PIN** parameter with the help of the $\Delta\nabla$ scroll keys.
- Acknowledge the selected parameter by pressing the **OK** key.
- Change the respective number with the $\Delta\nabla$\triangleleft$ scroll keys.$

- Acknowledge your change with the **OK** key.

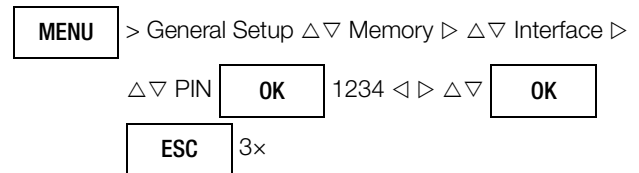

Establishing a Bluetooth® Connection

Establish connection to your PC, smartphone (Android) or tablet (Android) in the usual way for the respective system. Read the documentation included with the device in this regard.

The following instructions are provided as an example for a PC running Microsoft® Windows® 10.

- Activate Bluetooth® at the device (see section 9.1 on page 57).
- Open the Windows® start menu.
- Click **Settings**.
The **Windows Settings** dialog opens.
- Click the **Devices** button.
The **Devices** dialog appears with the **Bluetooth & other Devices** window.
- In Windows®, click the **Add Bluetooth or other Device** button in the **Add Bluetooth & other Devices** dialog.
The **Add a Device** dialog appears.
- Click the **Bluetooth** button.
The system searches for Bluetooth® devices. After some time, the device appears.



Note

If you have several multimeters, make sure that connection is established to the right multimeter!
The device name is helpful for the unequivocal identification (see section 6.8 on page 16).

- Click the device.
You're prompted to enter the device's PIN.
- Enter the PIN. See section 9.1 on page 57 concerning the PIN.
- Click the **Connect** button.
Connection is established and acknowledged by a confirmation message.
- Click the **Finish** button.
The devices are connected.

9.2 USB/WIFI



Note

System requirements:
A USB 3.0 or BCP (battery charging port) connection is recommended for reliable operation with power supply via the PC port.
A USB power supply with an output current of at least 1.5 A is recommended for operation directly at the mains.

Optionally, the multimeter can be connected to a PC via the USB mains module, see “Mains Module with USB Port” on page 12. Connection to a PC is indicated by a corresponding icon, see “Symbols Used in the Digital Display” on page 9.

The following software can be used via the USB interface:

- Data Reader, see “METRAHIT IM Data Reader (PC)” on page 58
- Sequence Manager, see “Sequence Manager: Software for Test Sequences” on page 59

9.3 Software for Receiving and Evaluating Data

We recommend **METRAHIT IM Data Reader** software for your PC. Alternatively, you can retrieve measured values using a terminal program.

Data can be conveniently displayed and evaluated on a smartphone (Android) or a tablet (Android) with the **METRALOG** app. We recommend **Sequence Manager** PC software for the management of measuring sequences.



Attention!

Always create a backup copy of your measurement data. Any and all liability for loss of data is excluded. Any and all liability is excluded for possible software errors, in particular also resulting from interaction with other applications.

9.3.1 METRAHIT IM Data Reader (PC)

METRAHIT IM Data Reader is PC software for transferring and reading out measurement data from the instrument to a PC. The measured values can be subsequently saved as a CSV file.



Note

Follow the steps shown below in the specified order. Otherwise it's not possible to establish a connection between **METRAHIT IM Data Reader** and the instrument.

Download & Installation

Complete information concerning current software and firmware, as well as instrument updates and options, can be found in the myGMC portal. Please register for free, after which you'll have access to the downloads and will always receive the latest information about your instrument.

<https://www.gmc-instruments.de/services/mygmc/>

For the **METRAHIT IM Data Reader**, download the **Download Help for Data Reader** file and the current **METRAHIT IM Data Reader** ZIP file.



Attention!

Read and follow the instructions in the **Download Help for Data Reader** file. It includes all important information about the program, such as system requirements and installation instructions.

Unpack the ZIP file and install the **METRAHIT IM Data Reader** in accordance with the instructions found in the **Download Help for Data Reader** file.

Connecting the Instrument to the PC

Connect the instrument to the PC to which the **METRAHIT IM Data Reader** has been installed via Bluetooth® (see section 9.1 on page 57) or via the USB mains module (see section 5.2 on page 12).

The driver for the USB mains module is automatically recognized as of Windows® 10. The driver has to be installed manually for earlier versions of the operating system (VCP driver from ST).

Starting the Program and Selecting the Instrument

If you're using more than one instrument, select the current instrument by name. Instructions on how to find your instrument's name are provided in section 6.8 on page 16.



Attention!

Do not start and use the **METRAHIT IM Data Reader** and the **Sequence Manager** at the same time. The programs interfere with each other's Bluetooth® communication.

- Start the program using the usual procedure for your operating system.

- Select your instrument by name from the list at the top left and click the **Connect** button. The instrument is connected to the **METRAHIT IM Data Reader**. Data are read in from the instrument to the program.



Note

If an error message appears indicating that the instrument cannot be found, check the Bluetooth® connection (see section 9.1 on page 57).

Program Controls

The **METRAHIT IM Data Reader** is only available in English.

The screenshot shows the software interface with the following labeled components:

- Device Selection List**: A list of available instruments at the top left.
- Connect**: A button to connect to the instrument.
- Connection Status**: A green indicator showing the instrument is connected.
- Group Filter**: A dropdown menu to filter data by group.
- Sequence Filter**: A dropdown menu to filter data by sequence.
- Help**: A button for user assistance.
- Reload Headers**: A button to refresh the data table headers.
- Measurement Data**: The main window displaying the data table.
- Save to File**: A button to export the data as a CSV file.
- Cancel Data Reading**: A button to stop the current data reading process.
- Read Data from Table**: A button to load data from a specific row in the table.

ID	Type	Date	Time	Func	Range	Parameter	Group	Sequence	Comment
1	Single	01.01.2021	00:12:30.7	Cal	0.00-3		MHMH_03.96.2011		
2	Single	01.01.2021	00:14:19.9	Cal	0.00-3		MHMH_03.96.2011		
3	Single	01.01.2021	00:15:28.9	Cal	0.00-3		MHMH_03.96.2011		
4	Single	01.01.2021	00:16:45.9	Cal	0.00-3		MHMH_03.96.2011		
5	Single	01.01.2021	02:16:16.9	VLOC	0.30-40		MHMH_03.96.2011	DownSequence	Spannung am Pl.
6	Single	26.08.2021	08:27:58.9	INACC	0.30-1		MHMH_03.96.2011	DownSequence	Spannung am Pl.
7	Single	26.08.2021	08:40:37.9	VACC2_F	0.30-9		MHMH_03.96.2011	DownSequence	Spannung am Pl.
8	Single	26.08.2021	14:37:18.9	INACC	0.30-1		MHMH_03.96.2011	DownSequence	Kontaktdruck Sa
9	Single	26.08.2021	17:04:32.9	PLD_ZW	0.30-1		MHMH_03.96.2011	DownSequence	Measur. Sa

Displaying, Filtering and Selecting Data

After connecting your instrument, data are displayed in the **Measurements** window.

You can use the filter function if you only want to display and save certain data. You can filter data according to groups (**Group Filter**) and sequences (**Sequence Filter**). Select a filter criterion from the respective selection list to this end. Available filter criteria depend on the imported measurement data – for example all sequences contained in the measurement data are displayed as filter criteria. In order to load data for all measurements, select the measurement's row and click **Read data from table**. The read-in process can be cancelled by clicking **Cancel Data Reading**. Select **Reload headers** in order to update the data. You can load data from a single measurement by double-clicking the corresponding line.

The measurement data are displayed in the **Measurement Data** window.

Data Storage

Measurement data which appear in the **Measurement Data** window (see above) can be saved as a CSV file. Click the **Save to file** button to this end.

9.3.2 Terminal Program (PC)

Read the documentation for your terminal program for further information.

9.3.3 METRALOG App (smartphone and tablet)

If you use a smartphone or a tablet with the Android operating system and a Bluetooth® interface, our **METRALOG** app provides the following functions in combination with the multimeter:

- Display of received multimeter measured values as: Digital or analog values, measured value curve Y(t), measured value logger
- Recording of measuring operations
- Transmission of logs via wireless services and network services
- Acoustic warning in the event that wireless connection is interrupted
- Trigger in the event of exceeding or falling short of an adjustable limit value
- Acoustic warning if a trigger event should occur

The **METRALOG** app can be obtained from the Google Play Store (see QR code to the right) and installed. Information regarding installation can be found at the Google Play Store and in the documentation for your mobile device.



Complete information on working with the app can be found in its own online help. Initial steps required after installation and for operation are described below.

- ⇒ Activate Bluetooth® at your measuring instrument.
- ⇒ Tap the app's icon on the mobile device in order to start the app.
- ⇒ Select multimeter from the list of receivable Bluetooth® devices.
The following message appears: "Connecting to measuring instrument via Bluetooth".
- ⇒ In order to enable wireless connection, enter the same PIN which you also entered under the multimeter's PIN interface parameter. After connection has been successfully established, an analog display appears and "Measurement completed" appears at the bottom right.
- ⇒ You can switch back and forth amongst digital display, Y(t) measured value curve and analog display in the footer at the left-hand side.
- ⇒ You can start or stop a measured value recording by tapping the REC symbol.
- ⇒ You can switch the display to the measured value logger overview by tapping the magnifying glass icon in the footer at the right-hand side. Measuring intervals can be selected here, in order to display them graphically or transmit them.

9.3.4 Sequence Manager: Software for Test Sequences

Test sequences (see section 8.16, "Measuring Sequences – Test Sequences") can be created and managed at the instrument or in more convenient **Sequence Manager** PC software. It provides the following functions:

- Import/export of sequences to and from a PC and the instrument via Bluetooth®
- Sequence editing functions:
 - Create new sequences
 - Add and delete test steps
 - Copy and paste test steps
 - Change the order of test steps
 - Edit comments
- Import/export of sequences as TXT files



Note

Observe the maximum possible number of test sequences and test steps per instrument!
Standard: 1 sequence with up to 10 steps for the METRAHIT IM XTRA BT and the METRAHIT IM E-DRIVE BT, none for the METRAHIT IM TECH BT.
With **Sequence Functions Expert**: 16 sequences with up to 63 test steps.



Note

Sequences with the identical names are possible!
Multiple sequences with identical names can be created and managed, as well as imported and exported, at the instrument and in the program.
In order to avoid confusion, rename or delete the sequences (see page 60).

Download & Installation

Complete information concerning current software and firmware, as well as instrument updates and options, can be found in the myGMC portal. Please register for free, after which you'll have access to the downloads and will always receive the latest information about your instrument.

<https://www.gmc-instruments.de/services/mygmc/>

For the **Sequence Manager**, download the **README.TXT** file and the current **Sequence Manager** ZIP file.



Attention!

Read and adhere to the **README.TXT** file. It includes all important information about the program, such as system requirements and installation instructions.

- ⇒ Unpack the ZIP file.
- ⇒ Run the installation file.
The installation wizard appears.
- ⇒ Follow the instructions displayed by the installation wizard.
- ⇒ The software is installed on your PC.

Starting the Program

Start the program using the usual procedure for your operating system.



Attention!

Do not start and use the **Sequence Manager** and the **METRAHIT IM Data Reader** at the same time.
The programs interfere with each other's Bluetooth® communication.

Program Controls



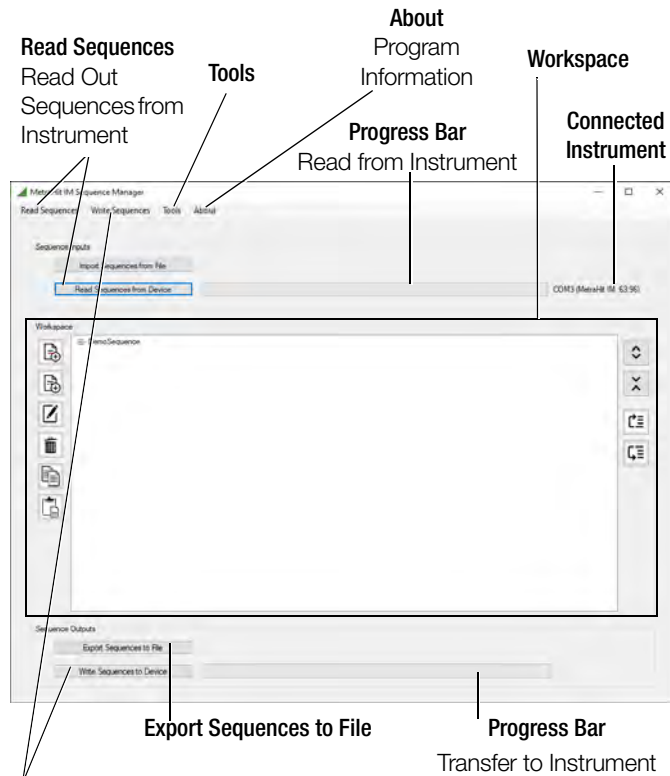







The **Sequence Manager** is only available in English.



Write Sequences

Transfer Sequence File to Instrument

Tools

-  Add new sequence
-  Add sequence step
-  Edit
-  Delete
-  Copy
-  Paste
-  Move up
-  Move down
-  Expand all items
-  Collapse all items

Reading in Sequences from the Instrument

If you want to edit test sequences which are stored at the instrument, they have to be read in to the program.

If you're using more than one instrument, the current instrument has to be selected by name. Instructions on how to find your instrument's name are provided in section 6.8 on page 16.

- Connect the instrument to your PC via Bluetooth® (see section 9.1 on page 57).
- Start the program using the usual procedure for your operating system.
- Click the **Read Sequences from Device** button. The **Read Sequences from Device** dialog appears.
- Select your instrument from the **Please select the device port** list.
- Click the **Read** button.
- The test sequences are imported from the device and can be edited in the program. The **progress bar** shows the read-in status.



Note

If an error message appears indicating that the port cannot be connected, check the Bluetooth® connection (see section 9.1 on page 57).

Creating and/or Editing Sequences

With help of the appropriate tools, you can create, edit or delete test sequences, including test steps, in the **Workspace**.

First of all, a new sequence has to be created or a sequence must be selected which has been imported from the instrument. When creating or editing a test step, select the desired measurement from the **Measurement Function** list. Depending on the type of measurement, one or more selection lists appear underneath from which you select the measurement parameters. Optionally, a comment or note concerning the test step can be entered in the **Comment** field.

Transferring Sequences to the Instrument

After creating and/or editing test sequences, they can be transferred to an instrument. The sequences are then available at the instrument.



Attention!

Existing sequences are deleted!

During transfer, all existing sequences are first deleted from the instrument, after which the sequences from the program are written to the instrument.

In this case as well, the name of the current instrument must be known if more than one is in use. Instructions on how to find your instrument's name are provided in section 6.8 on page 16.

- Connect the instrument to your PC via Bluetooth® (see section 9.1 on page 57).
- Start the program using the usual procedure for your operating system.
- Click the **Write Sequences to Device** button. The **Write Sequences to Device** dialog appears.
- Select your instrument from the **Please select the device port** list.
- Click the **Write** button. The **progress bar** shows the transmission status.
- The test sequences are exported to the instrument and can be edited in the program.



Note

If an error message appears indicating that the port cannot be connected, check the Bluetooth® connection (see section 9.1 on page 57).

Saving Sequences as a File

Test sequences can be saved as a TXT file for use as a backup copy, as well as for subsequent transfer to other instruments (see below).

All sequences from the current workspace are always exported.

- ⇨ Click the **Export Sequences to File** button.
The save dialog appears.
- ⇨ Enter a memory location and a filename.
- ⇨ Confirm that the sequences should be saved.
- ⇨ The file is saved to your PC.

Importing Sequences from a File

Test sequences which have been saved as a TXT file (see above) can be imported to the program in order to edit them or transfer them to an instrument.

- ⇨ Click the **Import Sequences from File** button.
The selection dialog appears.
- ⇨ Select a test sequence file.
- ⇨ Confirm that the file should be opened.
- ⇨ The test sequences are imported to the program. The sequences can now be edited (see page 60) and/or transferred to an instrument (see page 61).

10 Characteristic Values

Measuring Function (input)	Measuring Range	Resolution at Upper Range Limit		Input Impedance		Intrinsic Uncertainty at Reference Conditions ±(... % rdg. + ... d)				Overload Capacity ²	
				≡	~ / ≅	30,000	3000	30,000	30,000	Value	Time
		30,000	3000			≡	≡	~ 1,11	≅ 1,11		
V	300 mV	10 μV		9 MΩ	9 MΩ // < 50 pF	0.15 + 10 ^{10/9}				1000 V DC AC RMS Sinusoidal ⁶	Cont.
	3 V	100 μV		9 MΩ	9 MΩ // < 50 pF	0.15 + 10					
	30 V	1 mV		9 MΩ	9 MΩ // < 50 pF	0.15 + 10		0.5 + 30 ²⁰	1.0 + 30 ²⁰		
	300 V	10 mV		9 MΩ	9 MΩ // < 50 pF	0.2 + 20					
	1000 V	100 mV		9 MΩ	9 MΩ // < 50 pF	0.2 + 20					
Voltage drop at approx. range limit							≡	~ 1,11	≅ 1,11		
A	300 μA	10 nA		70 mV		0.25 + 10				0.3 A 1 A	Cont. 5 min
	3 mA	100 nA		165 mV							
	30 mA	1 μA		190 mV		0.15 + 10		0.5 + 30	1.0 + 30		
	300 mA	10 μA		450 mV							
	1 A	100 μA		1.2 V							
Factor: 1:1/10/100/1000		Measurement input		Input Impedance			≡	~ 1,11	≅ 1,11		
A > C @ V _{AC} / V _{DC}	0.3/3/30/300 A		300 mV	Voltage measurement input approx. 9 MΩ (> V socket)		0.15 + 10 ¹⁰		0.5 + 30	1.0 + 30	Measurement input ⁶	
	3, 30, 300, 3 k A		3 V					Plus current transformer clamp error		1000 V	Max. 10 s
				Open-circuit voltage	Meas. current at range limit	±(... % rdg. + ... d)					
mΩ @ 1 A pulse (4-wire)	3 mΩ	0.001 mΩ		2.8 ... 3.8 V	1 A	1.0 + 20				± 0.6 V ₁₄	Cont.
	30 mΩ	0.01 mΩ		2.8 ... 3.8 V	1 A	0.5 + 7					
mΩ @ 200 mA (4-wire)	300 mΩ	0.1 mΩ		2.8 ... 3.8 V	1 A					± 0.6 V ₁₄	Cont.
	3 Ω	1 mΩ		> 4 V	200 mA	0.5 + 7 ¹⁶					
mΩ @ 20 mA (4-wire)	30 Ω	10 mΩ		> 4 V	20 mA	0.5 + 7				± 0.6 V ₁₄	Cont.
R _{Lo} (2-wire) ¹⁸ EN61557 ¹⁷	@ 200 mA: 3 Ω	1 mΩ		> 4 V	200 mA	2.5 + 10 ¹⁰				± 0.6 V ₁₅	Cont.
	@ 20 mA: 30 Ω	10 mΩ		> 4 V	20 mA	2.5 + 10 ¹⁰					
Ω (2-wire)	300 Ω	10 mΩ		< 1.4 V	Approx. 300 μA	0.2 + 30 ¹⁰				1000 V DC AC RMS Sinusoidal	Max. 10 s
	3 kΩ	100 mΩ		< 1.4 V	Approx. 100 μA	0.15 + 10 ¹⁰					
	30 kΩ	1 Ω		< 1.4 V	Approx. 10 μA	0.15 + 10					
	300 kΩ	10 Ω		< 1.4 V	Approx. 1 μA	0.15 + 10					
	3 MΩ	100 Ω		< 1.4 V	Approx. 0.2 μA	0.5 + 10					
30 MΩ	1 kΩ		< 1.4 V	Approx. 0.03 μA	2.0 + 10						
⊘ ¹⁹	300 Ω	100 mΩ		Approx. 3 V	Approx. 1 mA const.			1 + 5			
→	4.5 V ³	1 mV		Approx. 8 V				0.5 + 2			
				Discharge resistance	U _{0 max}	±(... % rdg. + ... d)					
F	30 nF	10 pF		10 MΩ	0.7 V	1.5 + 10 ^{4/10}				1000 V DC AC RMS Sinusoidal	Max. 10 s
	300 nF	100 pF		1 MΩ	0.7 V	1 + 6 ⁴					
	3 μF	1 nF		100 kΩ	0.7 V	1 + 6 ⁴					
	30 μF	10 nF		12 kΩ	0.7 V	1 + 6 ⁴					
	300 μF	100 nF		3 kΩ	0.7 V	5 + 6 ⁴					
					f _{min} ⁵	±(... % rdg. + ... d)					
Hz (V)/ Hz (A) Hz (A)[⊘]	300 Hz	0.01 Hz								Hz (V) ⁶ ; Hz(A) [⊘] ; ⁶ ; 1000 V Hz (A): ⁷	Max. 10 s
	3 kHz	0.1 Hz			1 Hz,						
	30 kHz	1 Hz			20 Hz,		0.05 + 5 ⁸				
	300 kHz	10 Hz									
		Resolution	Voltage MR ¹³	Frequency MR	±(... % MR + ... d)						
% ¹⁸	10.0 ... 90.0			15 Hz ... 1 kHz,	0.2% rdg. + 8 d					1000 V DC AC RMS Sinusoidal ⁶	Cont.
	10.0 ... 90.0	0.1%	3 V AC	> 1 kHz ... 4 kHz,	0.2% MR/kHz + 8 d						
	5.0 ... 95.0		30 V AC	15 Hz ... 1 kHz,	0.2% rdg. + 8 d						
	15.0 ... 85.0			> 1 kHz ... 4 kHz,	0.2% MR/kHz + 8 d						
RPM ¹⁸	30 ... 30,000	1 RPM									
						±(... % rdg. + ... K) ⁹					
°C / °F	Pt 100	-200 ... +850 °C	0.1 °C			0.5 + 1.5				1000 V DC/AC RMS Sinusoidal	Max. 10 s
	Pt 1000	-200 ... +850 °C				0.5 + 1.5					
	K (NiCr-Ni)	-250 ... +1372 °C				1 + 5					

¹ 15 ... 45 ... 65 Hz ... 100 kHz sinusoidal. See influence on page 63.

² At 0 ° ... +40 °C

³ Display up to 4.5, "OL" for higher values.

⁴ Applies to measurements at film capacitors

⁵ Lowest measurable frequency for sinusoidal measuring signals symmetrical to the zero point

⁶ Overload capacity of the voltage measurement input:

Power limiting: frequency × voltage max. 6 × 10⁶ V × Hz @ U > 100 V

⁷ Overload capacity of the current measurement input: see current measuring ranges for maximum current values

⁸ Input sensitivity, sinusoidal signal: 10% to 100% of the voltage or current measuring range, restriction in mV measuring range: 30% rdg. The voltage measuring ranges with max. 10 kHz apply in the A measuring range.

⁹ Plus sensor deviation

¹⁰ With active ZERO function

¹¹ Accuracy applies as of 1% MR. Values < 50 digits are suppressed at the zero point due to the TRMS transformer.

¹² 10 minute cool-down period

¹³ Required signal range: 30% to 100% of the voltage measuring range

¹⁴ The integrated FF1A/1000V fuse blows in the event of overloading.

¹⁵ The integrated FFO.315A/1000V fuse blows in the event of overloading.

¹⁶ For 30 mΩ and 300 mΩ measuring ranges with active TComp function

¹⁷ A test current of 200 mA must be selected for the 0.2 to 2Ω measuring range in order to check protective measures in accordance with the standard.

¹⁸ METRAHIT IM XTRA BT and METRAHIT IM E-DRIVE BT only

¹⁹ If the multimeter is in continuous operation, a temperature-induced offset of the zero point may occur during the first two hours. For individual measurements we recommend updating the position of the zero point by means of the ZERO function prior to each measurement. For long-term measurements we recommend switching on the instrument two hours before measurement and setting the zero point by means of the ZERO function immediately before the measurement.

²⁰ Applies to measurements with external power supply (PSU) as of 15 mV only.

Key: d = digit(s), MR = measuring range, rdg. = reading (measured value)

Insulation Measurement
(METRAHIT IM XTRA BT and METRAHIT IM E-DRIVE BT only)

Measuring Range	Resolution	Nominal Voltage U_{ISO}	Intrinsic Uncertainty at Reference Conditions $\pm(\% MR + d)$
3 ... 1000 V \approx ¹	1 V	Ri=1M Ω	3 + 3
300 k Ω ²	0.1 k Ω	50, 100, 250, 500, 1000 V	2 + 10
3 M Ω	1 k Ω	50, 100, 250, 500, 1000 V	2 + 10
30 M Ω	10 k Ω	50, 100, 250, 500, 1000 V	2 + 10
300 M Ω	100 k Ω	50, 100, 250, 500, 1000 V	5 + 10
3000 M Ω	1 M Ω	250, 500, 1000 V	5 + 10

- ¹ TRMS interference voltage measurement (V_{AC+DC}) with 1 M Ω input resistance, frequency response width: > 65 Hz ... 500 Hz, accuracy: 3% + 30 digits
² Current for the M Ω measurement with U_{ISO} is limited to 1 mA. And thus when measuring small insulation resistances, U_{Actual} deviates from U_{Set} , i.e. U_{Actual} is correspondingly smaller.
 Example: at R_{ISO} 200 k Ω max. 200 V

Measuring Function	Nominal Voltage U_N	Open-Circuit Voltage $U_{Omax.}$	Nominal Current I_N	Short-Circuit Current I_k	Acoustic Signal for	Overload Capacity Value	Overload Capacity Time
$U_{interference}/M\Omega @ U_{ISO}$	—	—	—	—	$U > 1000$ V	1000 V \approx	Cont.
$M\Omega @ U_{ISO}$	50 100	$1.2 \times U_{INS}$	1.0 mA	< 1.4 mA	$U > 1000$ V	1000 V \approx	10 s
	250, 500 V 1000 V	$1.12 \times U_{ISO}$					

Inter-Turn Short Circuit Test (only with METRAHIT IM XTRA BT or METRAHIT IM E-DRIVE BT and optional COIL adapter)

Measuring Range	Resolution	Nominal Voltage U_{ISO}	Intrinsic Uncertainty at Reference Conditions $\pm(\% MR + d)$
0.3 V ... 1000 V \approx ¹		Ri=1M Ω	3 + 30 > 100 d
10.0 ... 30.9 μ s	0.1 [μ s]	1000 V	1% MR \pm 10 d ²
31 ... 250 μ s	1 [μ s]		

- ¹ TRMS interference voltage measurement (V_{AC+DC}) with 1 M Ω input resistance, frequency response width: > 65 Hz ... 500 Hz, accuracy: 3% + 30 digits
² The time value may vary by up to 10% for different COIL adapters. This is entirely without consequence if you perform measurements with the same COIL Adapter and compare them.

Inductance measuring ranges of optional COIL Adapters:

- COIL Adapter XTRA (Z270M): 10 μ H to 5 H
- COIL Adapter 50 mH (Z270F): 10 μ H to 50 mH

Internal Clock

Time format DD.MM.YYYY hh:mm:ss
 Resolution 0.1 s (measured values timestamp)
 Accuracy \pm 1 minute per month
 Temperature influence 50 ppm/K

Reference Conditions

Ambient temperature +23 °C \pm 2 K
 Relative humidity 40% ... 75%
 Meas. quantity frequency 45 Hz ... 65 Hz
 Meas. quantity waveform Sinusoidal
 Supply voltage 4.0 V \pm 0.1 V

Influencing Quantities and Influence Error*

Influencing Quantity	Sphere of Influence	Measured Qty./ Measuring Range ¹	Influence Error (...% rdg. + ... d)/10 K
Temperature	0 °C ... +21 °C and +25 °C ... +40 °C	V \approx	0.2 + 5
		V \approx	0.4 + 5
		300 Ω ... 3 M Ω	0.5 + 5
		30 M Ω	1 + 5
		mA/A \approx	0.5 + 5
		mA/A \approx	0.8 + 5
		30 nF ... 300 μ F	2 + 5
		Hz	0.2 + 5
		°C/°F (Pt100/Pt1000)	0.5 + 5

- ¹ With zero balancing

Frequency Influence for Voltage Measuring Ranges in the V_{AC} / V_{AC+DC} Measuring Functions

Frequency Range	Influence Error ¹		
	300 mV range \pm (...% MR + ... d)	3 V, 30 V, 300 V range ² \pm (...% MR + ... d)	1000 V range ² \pm (...% MR + ... d)
15 Hz ... 45 Hz,	2 + 30	2 + 30	2 + 30
> 65 Hz ... 1 kHz,	0.5 + 30	0.5 + 30	1 + 30
> 1 kHz ... 10 kHz,	2 + 30	1.5 + 30	10 + 30
> 10 kHz ... 20 kHz,	3 + 30	1.5 + 30	—
> 20 kHz ... 50 kHz,	3 + 30	5 + 30	—
> 50 kHz ... 100 kHz,	10 + 30	10 + 30	—

- ¹ For sinusoidal input signals > 10% to 100% of the range (mV range: as of 30% of the range), at 1% to 10% of the range: f < 50 kHz, intrinsic error increased by 0.2% of the upper range limit.
² Overload capacity of the voltage measurement input:
 Power limiting: frequency \times voltage max. 6×10^6 V \times Hz @ U > 100 V

Frequency Influence for Current Measuring Ranges in the I_{AC} / I_{AC+DC} Measuring Functions

Frequency Range	Influence Error ¹	
	300 μ A to 300 mA \pm (...% MR + ... d)	1 A range \pm (...% MR + ... d)
15 Hz ... 45 Hz,	2 + 30	2 + 30
> 65 Hz ... 1 kHz,	1 + 30	1 + 30
> 1 kHz ... 2 kHz,	1 + 30	1 + 30
> 2 kHz ... 5 kHz,	1 + 30	3 + 30
> 5 kHz ... 10 kHz,	5 + 30	5 + 30

- ¹ For sinusoidal input signals > 10% to 100% of the range.

Influencing Quantity	Sphere of Influence	Measured Qty./ Measuring Range	Influence Error ¹
Crest Factor CF	1 ... 3	V \sim , A \sim	\pm 1% rdg.
	> 3 ... 5		\pm 3% rdg.

- ¹ Except for sinusoidal waveform

Influencing Quantity	Sphere of Influence	Measured Quantity	Influence Error
Relative Humidity	75% 3 days instrument off	V, A, Ω , F, Hz, °C	1 \times intrinsic uncertainty
Battery Voltage	—	Ditto	in intrinsic uncertainty Included

Influencing Quantity	Sphere of Influence	Measured Qty./ Measuring Range	Damping
Common Mode Interference Voltage	Interference quantity max. 1000 V \sim 50 Hz ... 60 Hz sinusoidal	V \approx	> 90 dB
		3 V \sim ,	> 90 dB
		30, 300 V \sim	> 150 dB
Series Mode Interference Voltage	Interference quantity: V \sim , respective nominal value of the measuring range, max. 1000 V \sim , 50 Hz ... 60 Hz sinusoidal	V \approx	> 50 dB
		V \sim	> 50 dB

* Influence errors must be added to the intrinsic uncertainty.

Response Time (after manual range selection)

Measured Qty./ Measuring Range	Digital Display Setting Time	Jump Function of the Measured Quantity
V $\overline{=}$, V \sim A $\overline{=}$, A \sim	1.5 s	From 0 to 80% of upper range limit value
300 Ω ... 3 M Ω	2 s	From ∞ to 50% of upper range limit value
30 M Ω , M Ω @U _{ISO}	Max. 5 s	
Continuity	< 50 ms	
°C (Pt 100)	Max. 3 s	
\rightarrow	1.5 s	From 0 to 50% of upper range limit value
30 nF ... 300 μ F	Max. 5 s	
>10 Hz	1.5 s	

Display

TFT color graphic display (55 × 36 mm) with analog and digital display including unit of measure, type of current and various special functions

Background Illumination

Activated background illumination can be regulated by means of a light sensor.

Analog Bar Graph

Scaling	Linear
Polarity display	With automatic switching
Sampling rate	40 measurements per second and display refresh

Digital Measured Value Display

Resolution / character height	320 × 480 dots, 12 mm
Number of places	31000 / 3100 4¾-place in the V, A, Hz and Ω , measuring functions depending on parameter setting
Overflow display	“OL” is displayed for $\geq 31,000$ digits or ≥ 3100 digits
Polarity display	“–” (minus sign) is displayed if plus pole is connected to “ \perp ”
Sampling rate	10 and 40 measurements per second with the Min-Max function except for the capacitance, frequency and duty cycle measuring functions
Refresh rate	2 times per second, every 500 ms

Electrical Safety

Protection category	II per EN 6 010-1	
Measuring category	CAT III	CAT IV
Nominal voltage	1000 V	600 V
Pollution degree	2	
Test voltage	7.4 kV~ per EN 61 010-1	

Fuses

Current measuring ranges & 4-Wire m Ω measuring ranges	F1: FF 1 A/1000 V AC/DC, 6.3 × 32 mm Fuse with breaking capacity of 30 kA at 1000 V AC/DC, protects the current measurement input in the 300 μ A to 1 A ranges
2-Wire m Ω measuring ranges (METRAHIT IM XTRA BT and METRAHIT IM E-DRIVE BT only)	F2: FF 0.315 A / 1000 V 6.3 × 32 mm Fuse with breaking capacity of 30 kA at 1000 V AC/DC

Power Supply

Standard (included)

Battery pack	3.7 V, 4000 mAh, LiPo (approx. 25% self-discharging per year)
Operating time	approx. 20 hours (without M Ω _{ISO} measurement / R _{LO} / R 4-wire measurement)
Battery indicator	Battery capacity display via battery symbol:  , querying of momentary charge level via menu function
Power OFF function	The multimeter is switched off automatically: – when battery voltage drops to below approx. 3.6 V – if none of the keys or the rotary switch are activated for an adjustable duration of 10 to 59 min. and the multimeter is not in the continuous operating mode

Rechargeable battery packs can only be recharged externally.

Measuring Function	Nominal Voltage U _N	DUT Resistance	Operating Time in Hours	Number of Possible Measurements with Nom. Current per EN 61557
V $\overline{=}$			20 ¹	
V \sim			15 ¹	
RISO	100 V	1 M Ω	5	
	100 V	100 k Ω		300
	500 V	500 k Ω		60
	1000 V	2 M Ω		20

¹ Times 0.7 for interface operation

Optional: Mains Module with USB Port

Optionally, the instrument can also be powered using the USB mains module (see “Mains Module with USB Port” on page 12).



Note

System requirements:
A USB 3.0 or BCP (battery charging port) connection is recommended for reliable operation with power supply via the PC port.
A USB power supply with an output current of at least 1.5 A is recommended for operation directly at the mains.

The technical data for the USB mains module can be found in the corresponding supplementary sheet: 3-447-114-03.

Electromagnetic Compatibility (EMC)

Interference emission EN 61326-1:2013 class B

Interference immunity EN 61326-1:2013

Short-term measured value deviation of up to 10% may occur during electromagnetic interference thus reducing the specified operating quality.

Ambient Conditions

Accuracy range	0 °C ... +40 °C
Operating temperature (storage temp. with batt.)	–10 °C ... +50 °C –20 °C ... +50 °C with rubber holster
Storage temperature	–25 °C ... +70 °C (without battery)
Relative humidity	40 ... 75%, no condensation allowed
Elevation	to 2000 m
Place of use	Indoors, except within specified ambient conditions

Data Interface

Type	Bluetooth 4.2
Frequency band	2.402 ... 2.480 GHz
Transmission intensity:	+ 1,5 dBm
Transmitting power	Max. 91 mW
Functions	<ul style="list-style-type: none"> – Query measuring functions and parameters – Query momentary measurement data

Internal Measured Value Storage

Memory capacity	64 MBit for approx. 300,000 measured values with indication of date and time
-----------------	--

Mechanical Design

Housing	Impact resistant plastic (ABS)
Dimensions	235 × 105 × 56 mm (without rubber holster)
Weight	approx. 0.7 kg with battery pack
Protection	Housing: IP 52 (pressure equalization via the housing)

Table Excerpt Regarding Significance of IP Codes

IP XY (1 st digit X)	Protection Against Foreign Object Ingress	IP XY (2 nd digit Y)	Protection Against Water Ingress
0	Not protected	0	Not protected
1	≥ 50.0 mm Ø	1	Vertically falling droplets
2	≥ 12.5 mm Ø	2	Dripping (15° angle)
3	≥ 2.5 mm Ø	3	Spraying water
4	≥ 1.0 mm Ø	4	Splashing water
5	Dust protected	5	Jet-water

Applicable Regulations and Standards

EN 61010-1	Safety requirements for electrical equipment for measurement, control and laboratory use – Part 1: General requirements
EN 61010-2-033	Safety requirements for electrical equipment for measurement, control and laboratory use – Part 2-033: Particular requirements for hand-held multimeters and other meters for domestic and professional use, capable of measuring mains voltage
EN 61326-1	Electrical equipment for measurement, control and laboratory use – EMC requirements – Part 1: General requirements
EN 60529	Test instruments and test procedures – degrees of protection provided by enclosures (IP code)
EN 61557-1 (METRAHIT IM XTRA BT and METRAHIT IM E-DRIVE BT only)	Electrical safety in low voltage distribution systems up to 1000 V AC and 1500 V DC – Equipment for testing, measuring or monitoring of protective measures Part 1: General requirements
EN 61557-2 (METRAHIT IM XTRA BT and METRAHIT IM E-DRIVE BT only)	Part 2: Insulation resistance
EN 61557-4 (METRAHIT IM XTRA BT and METRAHIT IM E-DRIVE BT only)	Part 4: Resistance of earth connection and equipotential bonding

11 Maintenance and Calibration

11.1 Displays – Error Messages

Message	Function	Meaning
FUSE	Current measurement	Blown fuse
	In all operating modes	Battery voltage has fallen below 3.3 V
OL	Measurement	Indicates overflow

11.2 Fuses

Two measuring range inputs in the instrument are equipped with one fuse each:

F1 = current measuring function

F2 = Rlo measuring function
(METRAHIT IM XTRA BT and METRAHIT IM E-DRIVE BT only)

Maximum permissible voltage (= nominal voltage of the fuse) is 1000 V AC/DC each, and minimum breaking capacity is 30 kA each.

Both fuses are tested automatically:

- When the instrument is switched on with the rotary switch in the A position
- When the instrument is already on and the rotary switch is turned to the A position
- In the active current measuring range when voltage is applied

If a fuse is blown or if no fuse has been inserted the "FUSE" symbol appears at the display. The respective fuse interrupts the associated measuring ranges. All other measuring ranges remain functional.

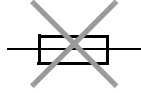

Replacing the Fuse

Attention!
If a fuse should blow, eliminate the cause of overload before placing the instrument back into service!

Attention!
Disconnect the instrument from the measuring circuit before opening the fuse cover in order to replace the fuse!

- ⇨ Switch the instrument off.
- ⇨ Remove the rubber holster if applicable.
- ⇨ Set the instrument face down onto the working surface.
- ⇨ Loosen the screw in the fuse compartment cover (see figure at right).
- ⇨ Lift off the cover with the screw and set it aside.
- ⇨ Pry the blown fuse out using the flat side of the fuse cover.
- ⇨ Insert a new fuse. Make sure that the fuse is centered, i.e. between the tabs at the sides.



Attention!
Use only the specified fuse type! The fuse must have a breaking capacity of at least 30 kA (see page 64). The use of repaired fuses or short-circuiting the fuse holder is prohibited.

If fuses with other blowing characteristics, other current ratings or other breaking capacities are used, the operator and the instrument are placed in danger.

- ⇨ Replace the fuse compartment cover. In doing so, insert the side with the guide hooks first.
- ⇨ Retighten the screw for the fuse compartment cover.
- ⇨ Replace the rubber holster.
- ⇨ Dispose of the blown fuse with household trash.

11.3 Housing Maintenance

No special maintenance is required for the housing. Keep outside surfaces clean. Use a slightly dampened cloth for cleaning. In particular for the protective rubber surfaces, we recommend a moist, lint-free microfiber cloth. Avoid the use of cleansers, abrasives and solvents.

11.4 Measurement Cables

Inspect the measurement cables for mechanical damage at regular intervals.

Attention!
Even in the case of minimal damage to the test leads, we recommend sending them to GMC-I Service GmbH without delay.

11.5 Recalibration

The measuring tasks performed with your instrument, and the stressing it's subjected to, influence aging of its components and may result in deviation from the specified levels of accuracy.

In the case of strict measuring accuracy requirements, as well as in the event of use at construction sites with frequent stress due to transport and considerable temperature fluctuation, we recommend a relatively short calibration interval of once per year. If your instrument is used primarily in the laboratory and indoors without considerable climatic or mechanical stressing, a calibration interval of once every 2 to 3 years is sufficient as a rule.

During recalibration* at an accredited calibration laboratory (DIN EN ISO/IEC 17025), deviations from traceable standards demonstrated by your measuring instrument are documented. Ascertained deviations are used to correct display values during later use of the instrument.

We would be happy to perform DAkkS or factory calibration for you at our calibration laboratory. Further information is available on our website:

www.gossenmetrawatt.com (→ COMPANY → Sustainability & Quality at Gossen Metrawatt GmbH → DAkkS Calibration Laboratory → Calibration Questions and Answers).

Recalibration of your instrument at regular intervals is essential for the fulfillment of requirements according to quality management systems per DIN EN ISO 9001.

Note
The test instrument should be calibrated at regular intervals in a calibration laboratory accredited in accordance with DIN EN ISO/IEC 17025.

* Examination of the specification, as well as adjustment, are not included in calibration. However, in the case of our own products, any required adjustment is performed and adherence to the specification is confirmed.

12 Accessories

12.1 General

The extensive accessories available for our instruments are checked for compliance with currently valid safety regulations at regular intervals, and are expanded as required for new applications.

You'll find the right product-specific and recommended universal accessories for your instrument with all the information you need (description, order number, etc.)

- on the Internet at www.gossenmetrawatt.com
- in the data sheet for your instrument.

12.2 Technical Data for Measurement Cables (included with KS17-2 cable set and Z270S probe)

Electrical Safety

Maximum rated voltage	600 V	1000 V	1000 V
Measuring category	CAT IV	CAT III	CAT II
Maximum rated current	1 A	1 A	16 A
With safety cap attached	•	•	—
Without safety cap	—	—	•

Observe the measuring instrument's maximum values for electrical safety!

Ambient Conditions (EN 61010-031)

Temperature	-20 °C ... + 50 °C
Relative humidity	50 ... 80%
Pollution degree	2

Use of KS17-2 and Z270S



Attention!

Measurements per DIN EN 61010-031 may only be performed in environments in accordance with measuring category III with the safety cap attached to the test probe at the end of the measurement cable.

In order to establish contact inside 4 mm jacks, the safety caps have to be removed by prying open the snap fastener with a pointed object (e.g. the other test probe).

13 Returns and Environmentally Sound Disposal

This instrument is subject to directive 2012/19/EC on Waste Electrical and Electronic Equipment (WEEE) and its German national equivalent implemented as the Waste Electrical and Electronic Equipment Act (ElektroG) on the marketing, return and environmentally sound disposal of electrical and electronic equipment. The device is a category 9 product (monitoring and control instrument) in accordance with ElektroG (German Waste Electrical and Electronic Equipment Act).



The symbol at the left indicates that this device and its electronic accessories must be disposed of in accordance with applicable legal regulations, and not together with household trash. In order to dispose of the instrument, bring it to a designated collection point or contact our product support department (page 69).

This instrument is also subject to directive 2006/66/EC on batteries and accumulators and waste batteries and accumulators and its German national equivalent implemented as the Battery Act (BattG) on the marketing, return and environmentally sound disposal of batteries and accumulators.



The symbol at the left indicates that batteries and rechargeable batteries must be disposed of in accordance with applicable legal regulations. Batteries and rechargeable batteries may not be disposed of with household trash. In order to dispose of the batteries or rechargeable batteries, remove them from the instrument and bring them to a designated collection point.

Segregated disposal and recycling conserves resources and protects our health and the environment.

Current and further information is available on our website at <http://www.gossenmetrawatt.com> under the search terms "WEEE" and "environmental protection".

14 CE Declaration

The instrument fulfills all requirements of applicable EU directives and national regulations. We confirm this with the CE mark.

A factory calibration certificate or test report is included with the instrument.

Gossen Metrawatt GmbH	Begleitende Formulare zum PEP EU-Konformitätserklärung / EU Declaration of Conformity	Form E0F34
------------------------------	--	-------------------

Hersteller / Manufacturer: Gossen Metrawatt GmbH
 Anschrift / Address: Südwestpark 15, 90449 Nürnberg

Produktbezeichnung/ Multimeter, Isolationstester & Milliohmmeter
 Product name: Multimeter, Isolation Tester & Milliohm Meter
 Typ / Type: METRAHIT IM TECH (BT) | XTRA (BT) | E-DRIVE (BT) | E-DRIVE FUSO
 Bestell-Nr / Order No: M272B /S | M273B /D /S | M274B /S /F /I

Der oben beschriebene Gegenstand der Erklärung erfüllt die einschlägigen Harmonisierungsvorschriften der Union; / The object of the declaration described above is in conformity with the relevant Union harmonisation legislation:

2014/53/EU	RED - Richtlinie	RED Directive
------------	------------------	---------------

Anforderungen an die Sicherheit gemäß 2014/35/EU (Niederspannungsrichtlinie) /
 Safety requirements according to 2014/35/EU (Low Voltage Directive)

EN/Norm/Standard:

EN 61010-1 : 2010 + A1 : 2019 + A1 : 2019/AC : 2019 ,
 EN 61010-2-033 : 2012

Anforderungen an die elektromagnetische Verträglichkeit gemäß 2014/30/EU (EMV Richtlinie) /
 Requirements for electromagnetic compatibility according to 2014/30/EU (EMC Directive)

EN/Norm/Standard:

EN 61326-1 : 2013

2011/65/EU	RoHS - Richtlinie	RoHS Directive
(EU) 2015/863	Delegierte Richtlinie	Delegate Directive

EN/Norm/Standard:

EN IEC 63000 : 2018

Nürnberg, 08.08.2023

Ort, Datum / Place, Date:

Matthias Wist, Geschäftsführung / Managing Director

Die alleinige Verantwortung für die Ausstellung dieser Konformitätserklärung trägt der Hersteller. Sie beinhaltet jedoch keine Zusage von Eigenschaften. Die Sicherheitshinweise der mitgelieferten Produktdokumentationen sind zu beachten.

This Declaration of Conformity is issued under the sole responsibility of the manufacturer but does not include a property assurance. The safety notes given in the product documentation which are part of the supply, must be observed.

Datei:	Ausgabe:	Erstellt:	Freigabe:
23-2-M272X-M273X-M274X-CE-Entwurf	15.01.2021	Eckl	Weiß

15 Addresses

15.1 Product Support

Technical Queries

(use, operation, software registration)

If required please contact:

Gossen Metrawatt GmbH

Product Support Hotline

Phone: +49-911-8602-0

Fax: +49 911 8602-709

e-mail: support@gossenmetrawatt.com

15.2 Recalibration Service

We **calibrate** and **recalibrate** all instruments supplied by Gossen Metrawatt GmbH, as well as other manufacturers, at our service center, for example after one year within the framework of your test equipment monitoring program, as well as prior to use etc. See also section 11.5.

15.3 Repair and Replacement Parts Service Calibration Center * and Rental Instrument Service

If required please contact:

GMC-I Service GmbH

Service Center

Beuthener Str. 41

90471 Nürnberg · Germany

Phone: +49-911-817718-0

Fax: +49-911-817718-253

e-mail: service@gossenmetrawatt.com

www.gmci-service.com

This address is only valid in Germany.

Please contact our respective representatives or subsidiaries for service in other countries.

* **DAkkS calibration laboratory for electrical quantities, registration no. D-K-15080-01-01, accredited per DIN EN ISO/IEC 17025**

Accredited quantities: direct voltage, direct current value, direct current resistance, alternating voltage, alternating current value, AC active power, AC apparent power, DC power, capacitance, frequency, temperature

Competent Partner

Gossen Metrawatt GmbH is certified in accordance with DIN EN ISO 9001.

Our DAkkS calibration laboratory is accredited by the Deutsche Akkreditierungsstelle GmbH (national accreditation body of the Federal Republic of Germany) under registration number D-K-15080-01-01 in accordance with DIN EN ISO/IEC 17025.

We offer a complete range of expertise in the field of metrology: from **test reports** and **factory calibration certificates** right on up to **DAkkS calibration certificates**.

Our spectrum of offerings is rounded out with free **test equipment management**.

As a full service calibration laboratory, we can calibrate instruments from other manufacturers as well.

© Gossen Metrawatt GmbH
Prepared in Germany • Subject to change, errors excepted • PDF version available on the Internet

All trademarks, registered trademarks, logos, product names and company names are the property of their respective owners.



Gossen Metrawatt GmbH
Südwestpark 15
90449 Nürnberg • Germany

Phone: +49 911 8602-0
Fax: +49 911 8602-669
e-mail: info@gossenmetrawatt.com
www.gossenmetrawatt.com