

**2052R/2062R**  
Wire Tracer Receiver

**2000T**  
Wire Tracer Transmitter

Users Manual

## **LIMITED WARRANTY AND LIMITATION OF LIABILITY**

Each Fluke product is warranted to be free from defects in material and workmanship under normal use and service. The warranty period is 1 year and begins on the date of shipment. Parts, product repairs, and services are warranted for 90 days. This warranty extends only to the original buyer or end-user customer of a Fluke authorized reseller, and does not apply to fuses, disposable batteries, or to any product which, in Fluke's opinion, has been misused, altered, neglected, contaminated, or damaged by accident or abnormal conditions of operation or handling. Fluke warrants that software will operate substantially in accordance with its functional specifications for 90 days and that it has been properly recorded on non-defective media. Fluke does not warrant that software will be error free or operate without interruption.

Fluke authorized resellers shall extend this warranty on new and unused products to end-user customers only but have no authority to extend a greater or different warranty on behalf of Fluke. Warranty support is available only if product is purchased through a Fluke authorized sales outlet or Buyer has paid the applicable international price. Fluke reserves the right to invoice Buyer for importation costs of repair/replacement parts when product purchased in one country is submitted for repair in another country.

Fluke's warranty obligation is limited, at Fluke's option, to refund of the purchase price, free of charge repair, or replacement of a defective product which is returned to a Fluke authorized service center within the warranty period.

To obtain warranty service, contact your nearest Fluke authorized service center to obtain return authorization information, then send the product to that service center, with a description of the difficulty, postage and insurance prepaid (FOB Destination). Fluke assumes no risk for damage in transit. Following warranty repair, the product will be returned to Buyer, transportation prepaid (FOB Destination). If Fluke determines that failure was caused by neglect, misuse, contamination, alteration, accident, or abnormal condition of operation or handling, including overvoltage failures caused by use outside the product's specified rating, or normal wear and tear of mechanical components, Fluke will provide an estimate of repair costs and obtain authorization before commencing the work. Following repair, the product will be returned to the Buyer transportation prepaid and the Buyer will be billed for the repair and return transportation charges (FOB Shipping Point).

**THIS WARRANTY IS BUYER'S SOLE AND EXCLUSIVE REMEDY AND IS IN LIEU OF ALL OTHER WARRANTIES, EXPRESS OR IMPLIED, INCLUDING BUT NOT LIMITED TO ANY IMPLIED WARRANTY OF MERCHANTABILITY OR FITNESS FOR A PARTICULAR PURPOSE. FLUKE SHALL NOT BE LIABLE FOR ANY SPECIAL, INDIRECT, INCIDENTAL OR CONSEQUENTIAL DAMAGES OR LOSSES, INCLUDING LOSS OF DATA, ARISING FROM ANY CAUSE OR THEORY.**

Since some countries or states do not allow limitation of the term of an implied warranty, or exclusion or limitation of incidental or consequential damages, the limitations and exclusions of this warranty may not apply to every buyer. If any provision of this Warranty is held invalid or unenforceable by a court or other decision-maker of competent jurisdiction, such holding will not affect the validity or enforceability of any other provision.

Fluke Corporation  
P.O. Box 9090  
Everett, WA  
98206-9090  
U.S.A.

11/99

# Table of Contents

Title	Page
Introduction.....	1
Contact Fluke .....	1
Safety Information.....	1
The Product .....	2
Receivers .....	3
Features.....	3
2052R Receiver Display.....	5
2062R Receiver Display.....	6
2062R Menu Navigation .....	8
Change the Trace Mode .....	8
Change Settings.....	9
View Help Screen .....	9
Change the Volume .....	9
Transmitter .....	10
Features.....	10
Magnetic Strap.....	12
The Clamp.....	13
Connect the Transmitter.....	14
Test Lead Connection.....	14
Clamp Connection.....	19
Set up the Transmitter .....	19
Use the Receiver .....	21
Smart Sensor Mode (2062R) .....	22
Quick Scan Mode (2052R) .....	24
Tip Sensor Mode .....	24
Breaker Mode .....	26
NCV Mode.....	29
Special Applications .....	30
Find a Broken or Open Wire .....	30
Find a Short in a Circuit .....	32
Trace Wires in Conduit or Pipe .....	34
Junction Box Method.....	34
Conductive Fish Tape or Wire Method .....	34
Trace a Shielded Wire .....	34
Find a Wire in a Bundle .....	36

De-energized Circuit .....	36
Energized Circuit.....	37
Map a Circuit.....	38
Test Leads.....	38
The Clamp .....	38
Maintenance.....	41
Clean the Product .....	41
Receiver Battery Replacement .....	42
Transmitter Battery Replacement.....	42
Battery Type Selection (2000T, 2052R).....	43
Transmitter Fuse Replacement.....	44
Product Disposal .....	44
Specifications.....	44

## Introduction

The Fluke 2052R and 2062R (the Receiver or the Product) are wire tracer receivers. The Fluke 2000T (the Transmitter or the Product) is a wire tracer transmitter. Use the Receiver to detect an electromagnetic signal in wires or cables.

Use the Receiver with the Transmitter in any mode except for non-contact voltage (NCV) mode to detect a specific wire. Use the Receiver in NCV mode without the Transmitter to trace wires based on the presence of AC voltage. See *Use the Receiver*. The application figures show the 2062R receiver, but the applications apply to both models unless otherwise noted.

## Contact Fluke

Fluke Corporation operates worldwide. For local contact information, go to our website: [www.fluke.com](http://www.fluke.com).

To register your product, or to view, print, or download the latest manual or manual supplement, go to our website: [www.fluke.com/productinfo](http://www.fluke.com/productinfo).

Fluke Corporation	Fluke Europe B.V.
P.O. Box 9090	P.O. Box 1186
Everett WA 98206-9090	5602 BD Eindhoven
U.S.A.	The Netherlands

+1-425-446-5500 [fluke-info@fluke.com](mailto:fluke-info@fluke.com)

## Safety Information

A **Warning** identifies hazardous conditions and procedures that are dangerous to the user. A **Caution** identifies conditions and procedures that can cause damage to the Product or the equipment under test.

General Safety Information is in the printed Safety Information document that shipped with the Product. To view the Safety document online, go to our website. See specific safety information in this document where applicable.

## The Product

Table 1 shows the items that may ship with the Product as part of a kit. The items are available for purchase individually.

Table 1. The Product



Item	Description	Item	Description
1	2052R receiver	5	i400 AC clamp (the Clamp)
2	2062R receiver	6	Magnetic strap
3	2000T transmitter		Batteries, not shown
4	2000ACC accessories kit		Case, not shown

## Receivers

The 2052R and 2062R receivers have different features and displays, but the Receivers detect energized or de-energized signals on wires in similar ways.













### Features

Table 2 shows the features of the Receivers.

Table 2. Receivers Features

Item	Description	Function
1	Volume button (2052R)	Adjusts the level of the volume the Product emits.
2	Tip sensor	Align the groove on top of the tip sensor with a wire or fuse to detect an electromagnetic signal. See <a href="#">Figure 9</a> .
3	Tip sensor LED	Lights up when the Receiver detects an electromagnetic signal.
4	Display	Shows the settings, test functions, and results.
5	Smart Sensor™ detector (2062R)	Located on the back of the Product. In Smart Sensor mode, detects an electromagnetic signal.

Table 2. Receivers Features

Item	Description	Function
6	Tactile barrier	<b>⚠️⚠️ Warning</b> <b>Hold the Product behind the tactile barrier.</b>
7	Mode button (2052R) 	Selects the mode. Push to cycle through the modes: quick scan, tip sensor, breaker, non-contact voltage (NCV) See <a href="#">Table 3</a> .
8	NCV button (2062R) 	Selects non-contact voltage (NCV) mode.
9	Sensitivity button 2052R:  ,  2062R:  , 	Push <b>+</b> to increase or <b>-</b> to decrease the level of sensitivity the Receiver uses to detect an electromagnetic signal.
10	Navigation buttons (2062R)  ,  ,  ,  , 	Use to navigate and set the menu options. See <a href="#">2062R Menu Navigation</a> .
11	Speaker	The Product emits a sound through the speaker.
12	Rubber over molded holster	Protects the Product.
13	Power button 	Turns on and off the Product. Push <1 sec to turn on the Product. Push and hold ≥2 sec to turn off the Product.
14	Hot stick attachment point	Point to attach a hot stick (sold separately).



## 2052R Receiver Display

The display shows different features based on the selected mode. [Table 3](#) shows the features on the display of the 2052R receiver. To use the Receiver, see [Use the Receiver](#).

**Table 3. 2052R Display Features**

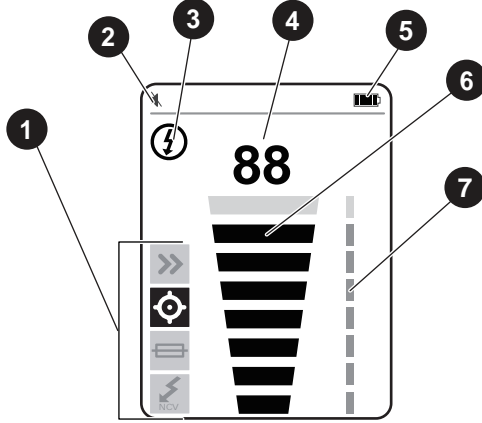

The diagram shows a smartphone-style display with the number '88' at the top. Below the number is a funnel-shaped graphic with horizontal bars. To the left of the funnel is a vertical menu with four icons: a right-pointing arrow, a gear, a battery, and a lightning bolt. To the right of the funnel is a vertical dashed line. Seven numbered callouts point to specific features: 1 points to the menu icons, 2 points to a volume indicator at the top left, 3 points to a lightning bolt icon at the top left, 4 points to the number '88', 5 points to a battery icon at the top right, 6 points to the funnel graphic, and 7 points to the vertical dashed line.

Item	Description	Function
①	Trace mode indicators	Shows the selected mode. See <a href="#">Use the Receiver</a> .
②	Volume level indicator	Volume level
③	Energy status indicator	⚡: In non-NCV modes, the Receiver detects a signal on a de-energized wire. ⚡: In non-NCV modes, the Receiver detects a signal on an energized wire. In NCV mode, the Receiver detects an AC signal within the specifications of the Product. See <a href="#">Transmitter</a> .

**Table 3. 2052R Display Features (cont.)**

<b>Item</b>	<b>Description</b>	<b>Function</b>
4	Numeric signal strength level	In Precision, Breaker, or NCV mode, shows the strength of the signal from 00 to 99.
5	Battery level indicator	Battery power level
6	Signal strength indicator	Based on the trace mode: Shows a toggle of signal detected or not detected, or shows the strength of the signal detected. See <a href="#">Use the Receiver</a> .
7	Sensitivity level	Shows the sensitivity level (1 to 8) of the Receiver.

## 2062R Receiver Display



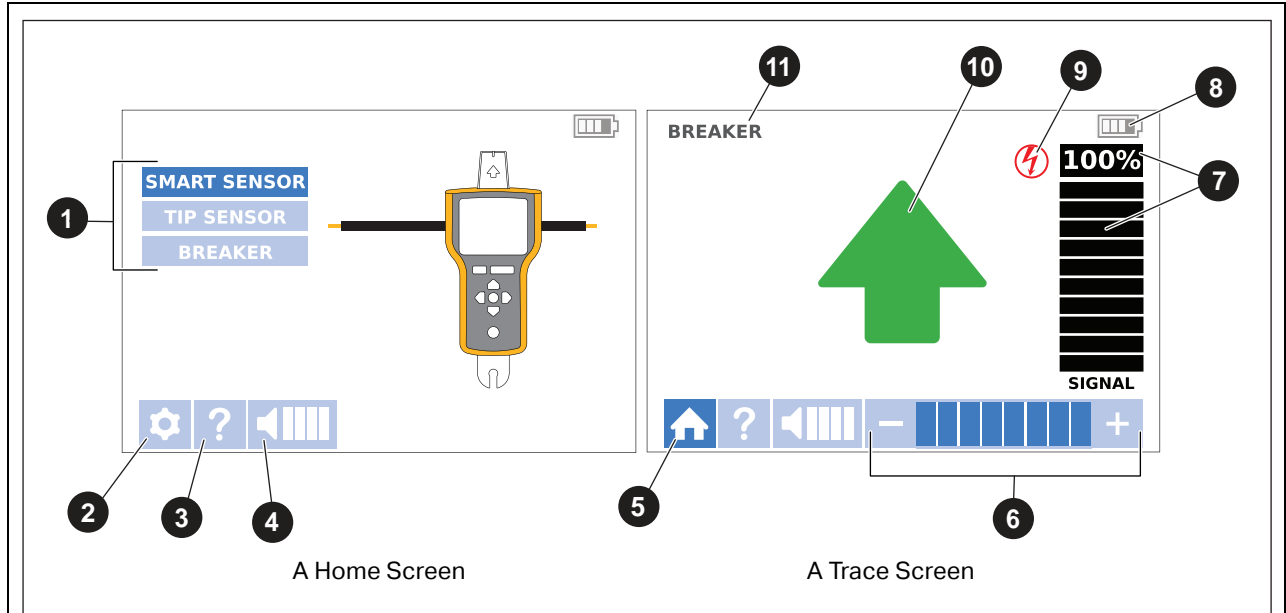

The display shows different features based on the selected mode. [Table 4](#) shows the features on examples of a home screen and a trace screen of the 2062R receiver. To use the Receiver, see [Use the Receiver](#).

Table 4. 2062R Display Features



Item	Description	Function
1	Trace mode selectors	Use with navigation buttons to set and show non-NCV trace modes. See <a href="#">Change the Trace Mode</a> .
2	Settings button	Opens the settings screen to select the language, brightness of the screen, volume, and type of breaker (GFI or RCD). See <a href="#">Change Settings</a> .
3	Help button	Opens the help screen to show an explanation of the symbols used on the interface. See <a href="#">View Help Screen</a> .
4	Volume button	Opens the volume menu to change the volume the Receiver emits. See <a href="#">Change the Volume</a> .
5	Home button	While in a trace mode or on the help screen, returns to a home screen.

**Table 4. 2062R Display Features (cont.)**

Item	Description	Function
6	Sensitivity level	While in a trace mode, shows the sensitivity level (1 to 8) of the Receiver.
7	Signal strength indicator	In a trace mode, shows the strength of the signal in a bar graph and as a percentage.
8	Battery level indicator	Battery power level.
9	Energy status indicator	In a non-NCV trace mode, indicates the Receiver:  : Detects a de-energized signal on a wire.  : Detects an energized signal on a wire.  : Does not detect a signal from the Transmitter.  : In NCV mode, the Receiver detects an AC signal within the specifications of the Product. See <a href="#">Transmitter</a> .
10	Trace mode information	In a trace mode, shows information about the trace test. See <a href="#">Use the Receiver</a> .
11	Trace mode	Shows the selected trace mode.



## 2062R Menu Navigation

Use the navigation buttons to change the trace mode, settings, or volume level, to view the help screen, or to return to the home screen.

### Change the Trace Mode

To change to NCV mode, push .

While not in an active trace test, to change to a trace mode other than the NCV mode:















1. Push / to highlight a selection.
2. Push  to set the selection.

When in an active trace test, push  to return to the home screen to select a new mode.

## Change Settings







Use the settings menu to set the language, screen brightness, and the breaker type (GFCI or RCD).

To change the settings:

1. Push  to highlight .
2. Push  to open the settings menu.
3. Push /// to highlight a selection.
4. Push  to set the selection.
5. To return to the home screen, Push /// to highlight .
6. Push .









## View Help Screen

To open the help screen:

1. Push  to highlight .
2. Push  to highlight .
3. Push  to open the help menu.
4. Push  to return to the home screen.

## Change the Volume

To change the volume:

1. Push  to highlight .
2. Push  to highlight .
3. Push  to open the volume menu.
4. Push / to adjust the volume.
5. Push  to set the volume and return to the home screen.

# Transmitter

Use the Transmitter to generate a signal on an energized or de-energized wire.

## Features

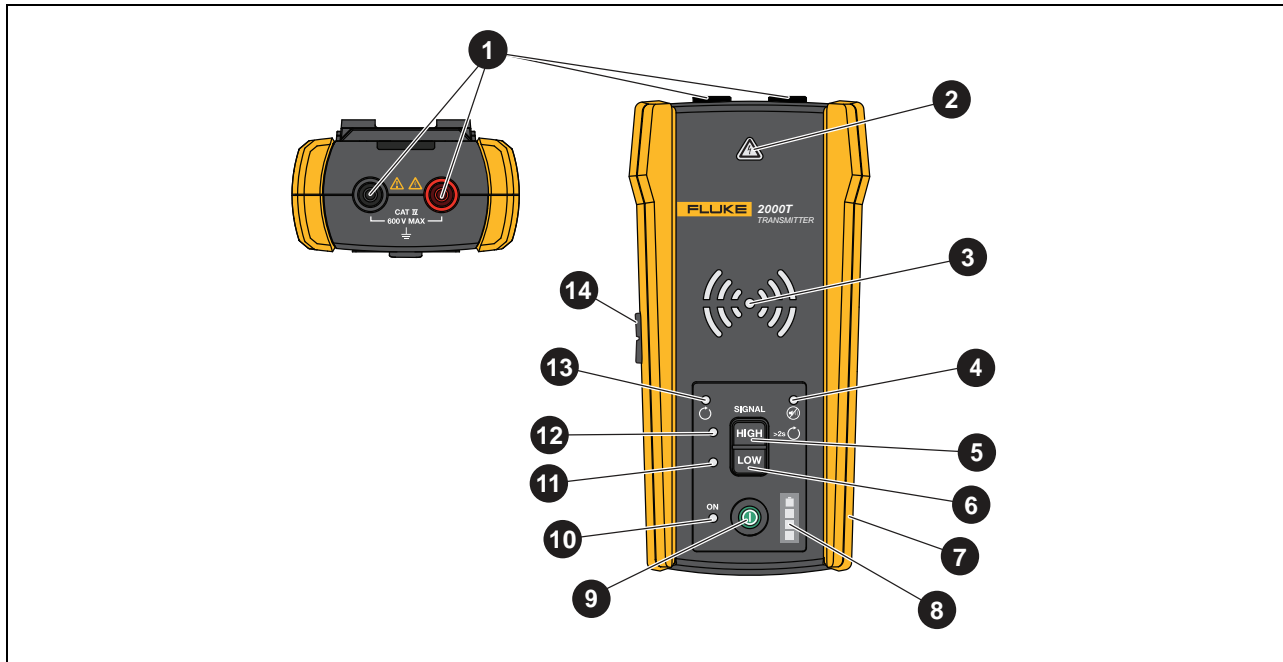

Table 5 shows the features of the Transmitter.

**Table 5. Transmitter Features**



Item	Description	Function
1	Input jacks	Use to connect the test leads to the Transmitter.
2	Voltage warning indicator 	With test leads connected to the circuit, indicates a de-energized, energized, or over-voltage signal detected in a circuit. See <a href="#">Set up the Transmitter</a> .

**Table 5. Transmitter Features (cont.)**

Item	Description	Function
3	Transmission mode LEDs	Blinks to indicate the mode of operation. Blinks quickly, progressively from the center to the outermost LEDs: Indicates high signal mode. Blinks slowly, progressively from the center to the outermost LEDs: Indicates low signal mode. All LEDs blink at the same time: Indicates loop mode.
4	Mute LED	Turns on when the volume is muted.
5	High mode/Loop mode button 	With Transmitter on, push <1 sec to generate a high signal on a wire. Push again to turn off high signal mode. See <a href="#">Set up the Transmitter</a> . With Transmitter on and not in high or low signal mode, push and hold ≥2 sec to turn on loop mode. See <a href="#">Set up the Transmitter</a> .
6	Low mode button 	With Transmitter on, push <1 sec to generate a low signal on a wire. Push again to turn off low signal mode. See <a href="#">Set up the Transmitter</a> . When in loop mode, push to turn off loop mode.
7	Rubber over molded enclosure	Protects the Product.
8	Battery level	Shows the battery power level.
9	Power button 	Turns on and off the Transmitter. Push <1 sec to turn on the Transmitter. Push and hold ≥2 sec to turn off the Transmitter.
10	Power LED	Emits light when the Transmitter is on.
11	Low mode LED	Emits light when low mode is selected.
12	High mode LED	Emits light when high mode is selected.
13	Loop mode LED	Emits light when loop mode is selected.
14	Volume button	Adjusts the level of the volume the Transmitter emits.

## Magnetic Strap

To attach the magnetic strap to the Transmitter, insert the strap through the slot on the back of the Transmitter and connect the hook and loop pieces **1** and **2** to each other. See [Figure 1](#). Attach the magnet **3** to a metallic object such as a beam to support the Transmitter.

**Figure 1. Magnetic Strap**

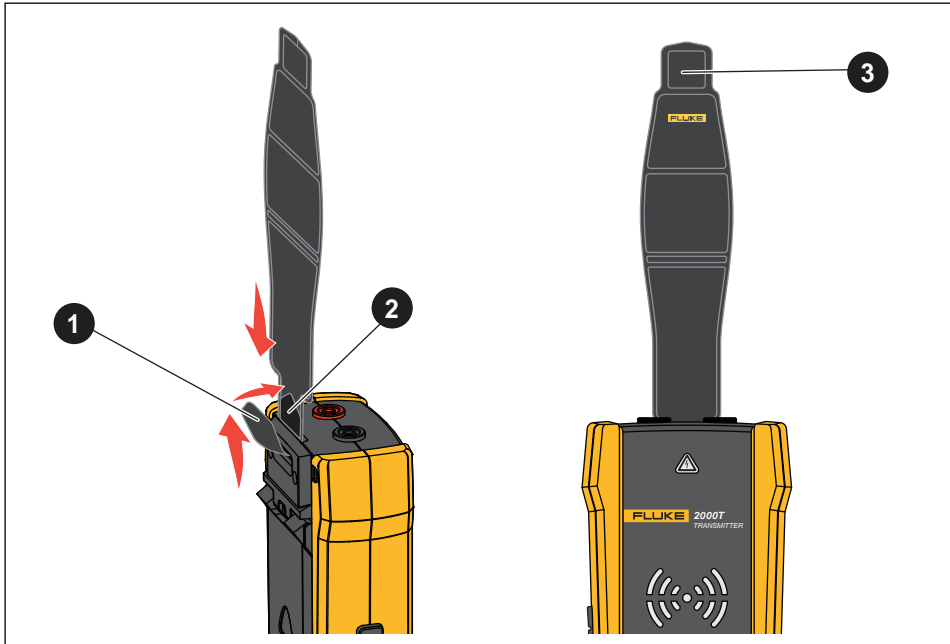



## The Clamp

When a direct connection to a conductive wire is not possible, use the Clamp with the Transmitter to generate a signal on a wire through the insulation around the wire. The Clamp works on low impedance closed circuits or to trace conduits or shielded wires grounded on both ends. To trace signal cables or de-energized wires or loads, first temporarily ground the circuit on both ends.

Table 6 shows the features of the Clamp.

Table 6. Clamp Features

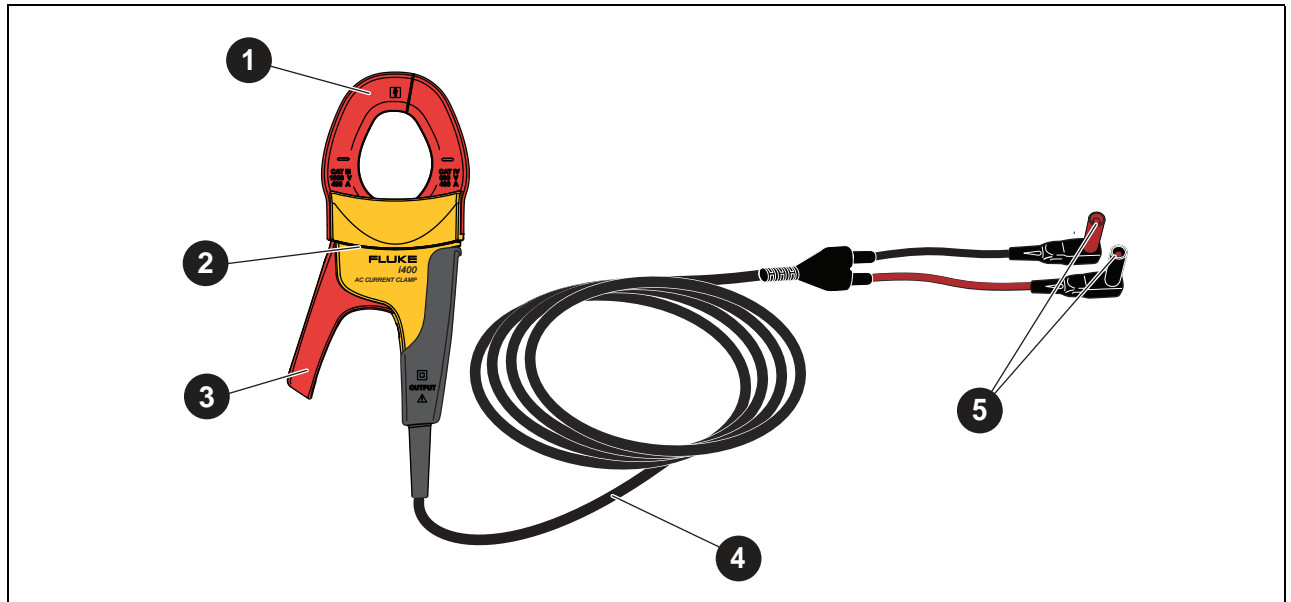

The diagram shows a red and yellow PLUKE 1450 AC Current Clamp. Callout 1 points to the red jaw. Callout 2 points to the yellow tactile barrier. Callout 3 points to the red jaw release. Callout 4 points to the black test leads. Callout 5 points to the connectors at the end of the test leads.

Item	Description	Item	Description
1	Jaw	4	Test leads
2	Tactile barrier	5	Connectors to Transmitter
3	Jaw release		

## Connect the Transmitter

The Transmitter generates a signal on a wire which creates an electromagnetic field around the wire. The Receiver detects the electromagnetic field to trace the wire.

With the Transmitter connected to two adjacent wires on the same circuit, the signal travels in one direction through the first wire and returns in the opposite direction through the second wire. This causes the creation of two electromagnetic fields around each wire with opposite direction. The opposite fields partially or completely cancel each other out which makes it difficult, if not impossible, to trace the signal.

## Test Lead Connection

To connect the Transmitter to a wire with test leads:

1. For most applications, connect the red and green test leads directly to the Transmitter. The polarity does not matter.
2. Connect the red test lead to the hot wire on the load-side of the circuit.

### *Note*

*For all applications, always connect the Transmitter on what would be the load-side of an energized circuit whether or not the circuit is energized or de-energized.*

3. Determine which type of circuit the wire to trace is on:
  - Not connected to a GFI device or an RCD
  - Connected to a GFI outlet
  - Connected to a GFI breaker
  - Connected to an RCD
4. To trace a wire on a circuit not connected to a GFI device or an RCD, connect the green test lead to a separate ground such as a metal water pipe, a metal grounded structure of the building, a grounded screwdriver, or a grounded stake.

With the Transmitter connected to a ground wire on a different circuit than the hot wire, the Receiver can detect the signal only if the wires on both circuits are connected correctly. The best practice is to connect to a separate ground.

Outlet and breaker types vary. [Figure 2](#) shows a few examples of outlet and breaker type connections.

Figure 2. Wire not Connected to a GFI Device or RCD

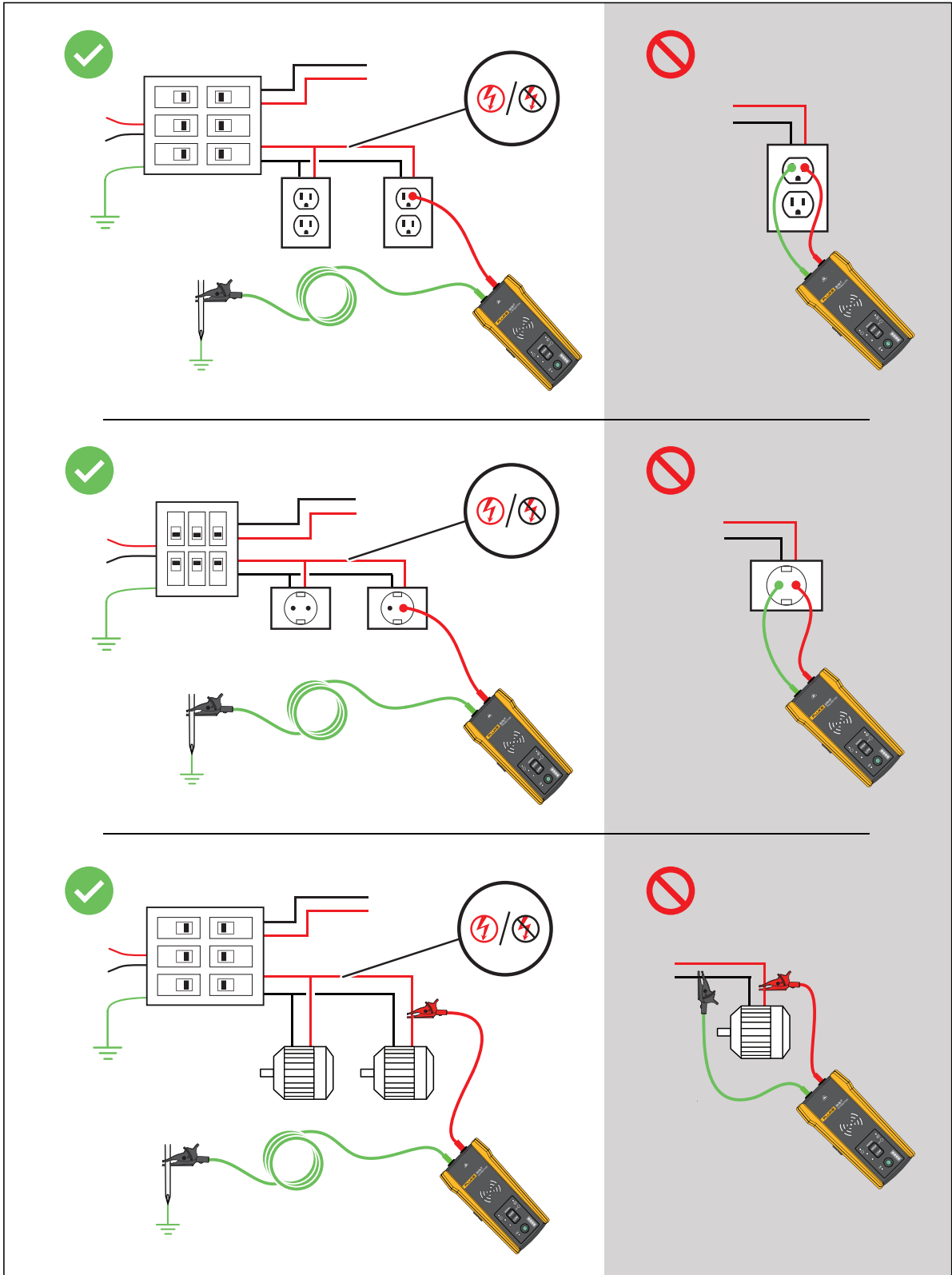

5. To trace a wire connected to a GFI outlet:
  - a. Remove the protective receptacle wall plate.
  - b. Connect the red alligator clip to the screw of the hot wire.
  - c. Connect the alligator clip of the green test lead to a separate ground such as a metal water pipe, a metal grounded structure of the building, a grounded screwdriver, or a grounded stake. See [Figure 3](#).

**Figure 3. Wire Connected to a GFI Outlet**

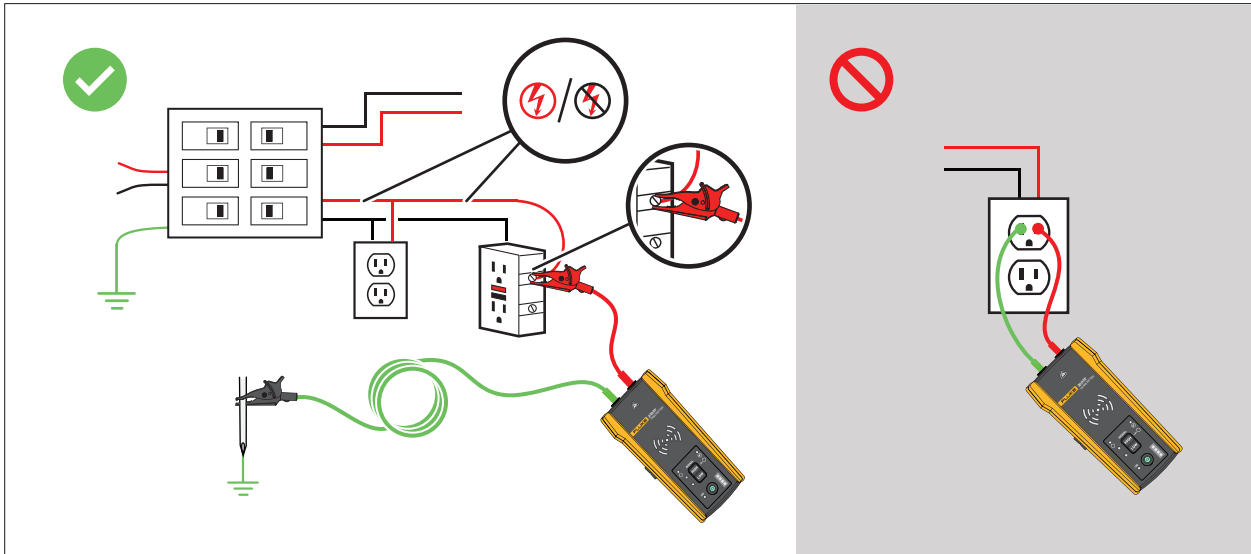

6. To trace a wire connected to a GFI breaker:
  - a. Locate the closest connection to the breaker or fuse panel that is on a different branch of the same circuit that is connected to the same GFI breaker.
  - b. Connect the green test lead to the neutral wire of the identified closest connection. See [Figure 4](#).

Figure 4. Wire Connected to a GFI Breaker

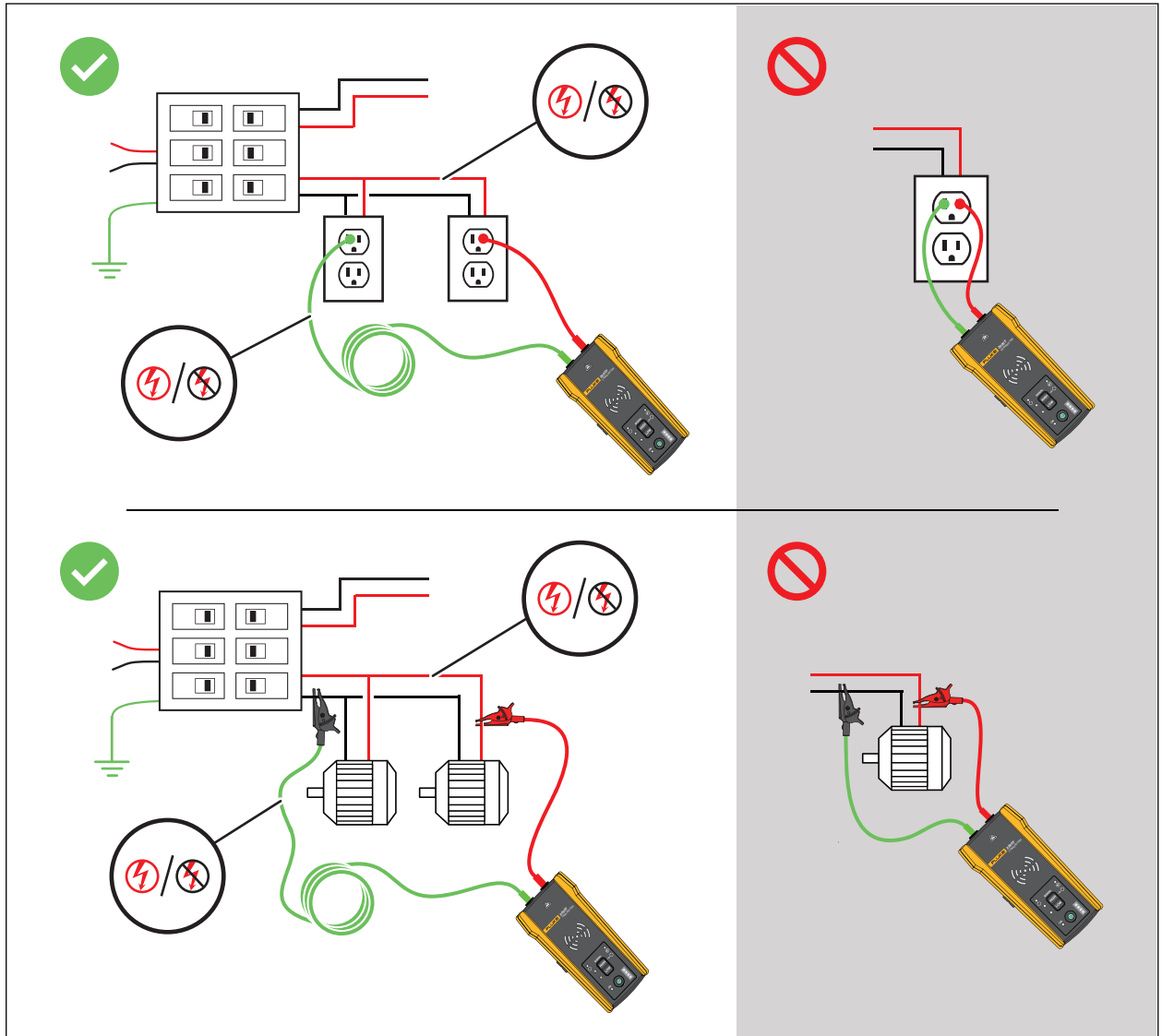

7. To trace a wire on a circuit connected to an RCD:
  - a. Locate the closest connection to the breaker or fuse panel that is on a different branch of the same circuit that is connected to the same RCD as the line or phase wire.
  - b. Connect the green test lead to the neutral wire of the identified closest connection. See [Figure 5](#).

**Figure 5. Wire Connected to an RCD**

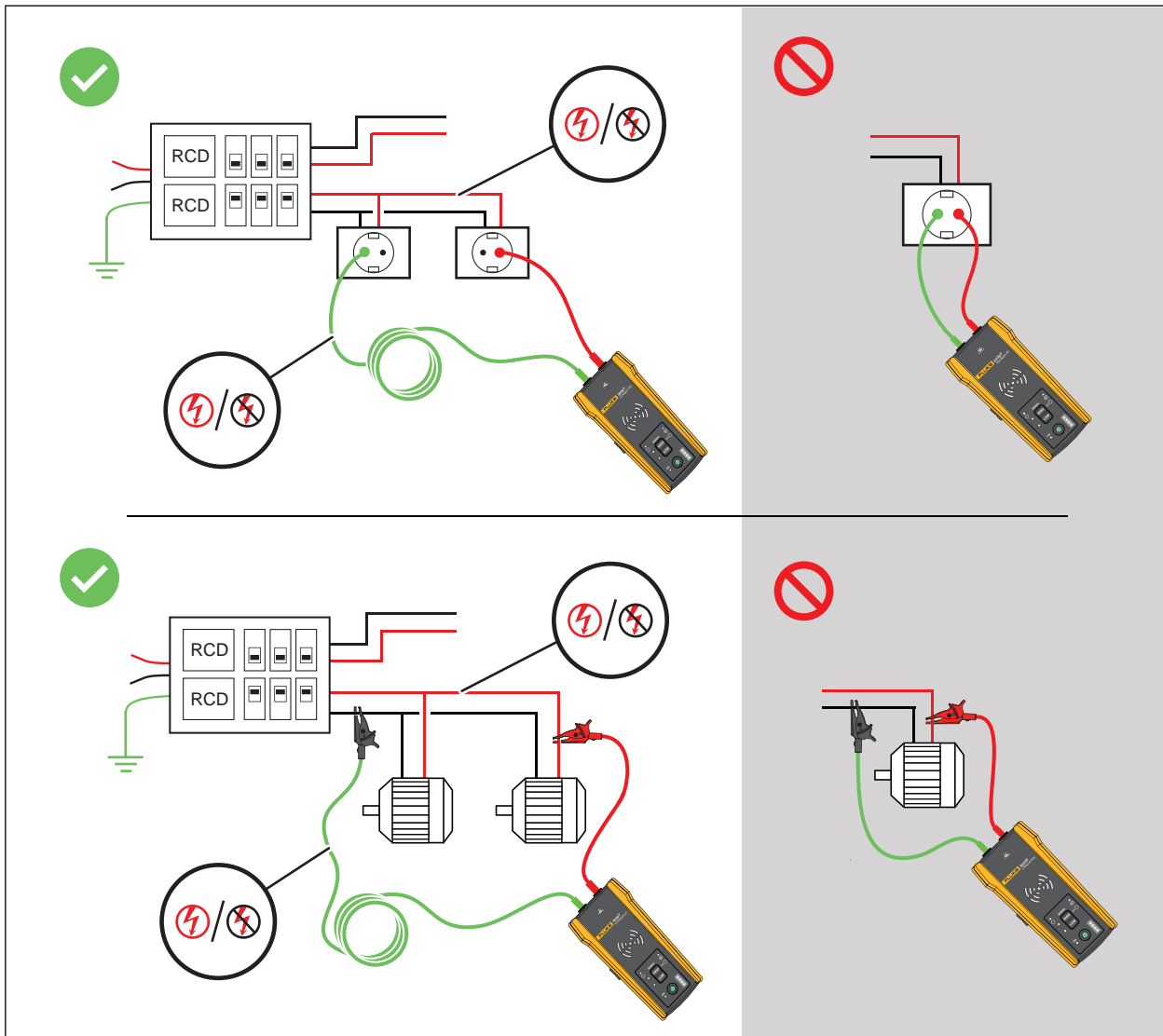

## Clamp Connection

### Note

*Because the Clamp does not have a direct connection to a conductive wire, the signal may not be strong enough for the Receiver to detect very far from the Clamp. When possible use test leads to make a direct connection to a conductive wire.*

### ⚠️⚠️ Warning

**To prevent possible electrical shock, fire, or personal injury, read all safety information in the i400 AC Clamp Instructions before you use the Clamp.**

To connect the Transmitter to a wire with the Clamp (see [Figure 6](#)):

1. Connect the tests leads of the Clamp to the Transmitter. The polarity does not matter.
2. Connect the Clamp around the wire.

**Figure 6. The Clamp Connection**

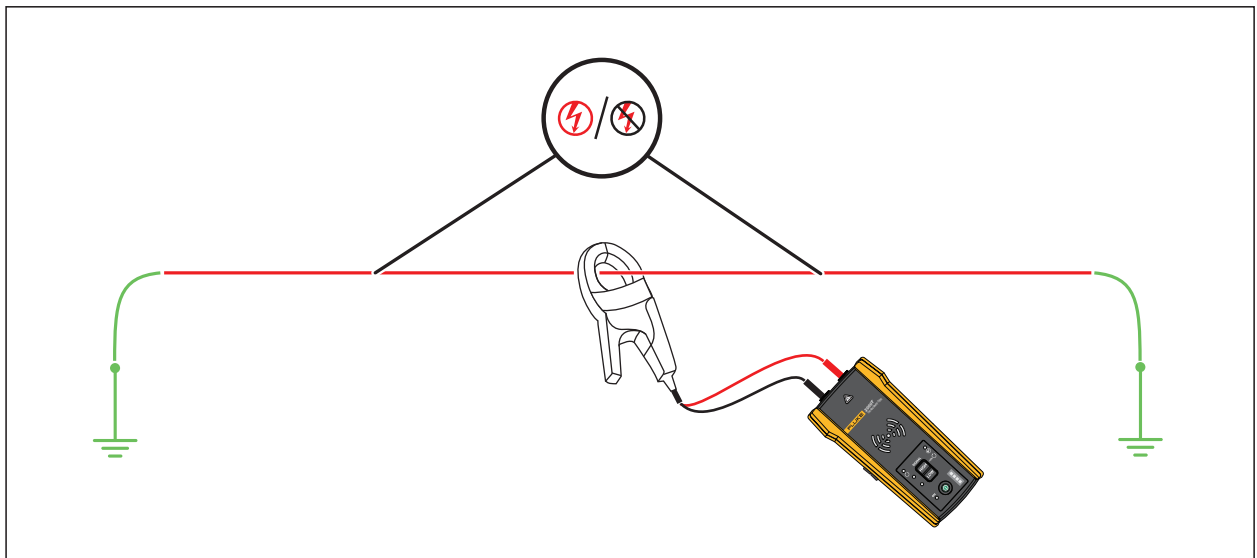



## Set up the Transmitter

With the Transmitter connected to a circuit and turned on, the Transmitter generates a signal on a wire and detects the voltage on the wire. Based on the voltage detected, the Transmitter automatically selects energized or de-energized mode. Loop mode only generates a signal on de-energized wires in a closed circuit.

**Energized mode:** When the Transmitter detects a voltage ( $\geq 35$  V ac/dc to 600 V ac/dc and 40 Hz to 400 Hz) on the wire, the Transmitter operates in energized mode. In energized mode, the Transmitter draws a low current from the energized circuit and generates a 6 kHz signal in a direct path to the power source. The signal does not travel onto any of the branches of the circuit. The low transmission frequency reduces signal coupling between wires. The signal does not harm sensitive equipment connected to the circuit. To use energized mode, connect the Transmitter on the load side of the circuit.

**De-energized mode:** When the Transmitter detects a voltage ( $< 35$  V ac/dc) on the wire, the Transmitter operates in de-energized mode. In de-energized mode, the Transmitter generates a 33 kHz signal that travels through all the branches of the circuit. De-energized mode uses a higher frequency to generate a reliable signal. The signal does not harm sensitive equipment on the circuit.

To use the Transmitter:

1. Connect the Transmitter. See [Connect the Transmitter](#).
2. Push  to turn on the Transmitter.
3. Verify the status of the voltage warning indicator  shows as expected.

With test leads connected:

- Off: Indicates a de-energized signal ( $< 35$  V ac/dc) in a circuit.
- Solid red: Indicates an energized signal ( $\geq 35$  V ac/dc to 600 V ac/dc and 40 Hz to 400 Hz) in a circuit.
- Blinking red: Indicates an energized over-voltage signal ( $\geq 600$  V ac/dc) in a circuit.

  **Warning**

**When the indicator blinks, disconnect the transmitter from the circuit immediately.**



*Note*

*With the Clamp connected, the voltage warning indicator shows as off because the Transmitter cannot determine if the wires inside the cable are energized or de-energized.*

4. Select a signal mode. [Table 7](#) lists the signal modes and describes the applications for each mode.



**Table 7. Signal Modes**

Mode	Description
High	Push  <1 sec to use high mode for most applications.
Low	Push  to use low mode to trace a precise wire.  In low mode, the Transmitter generates a low signal level to not oversaturate the Receiver with a signal that covers too large of an area. A low signal level also reduces coupling to nearby wires and metal objects that may make it difficult to trace a specific wire.
Loop	Push and hold  for $\geq 2$ sec to turn on loop mode.  Use loop mode to trace de-energized wires in a closed circuit such as shorted wires, shielded cables, or wires grounded on the far end. Loop mode automatically disables when the Transmitter connects to an energized wire. Use loop mode for applications with the Clamp.

## Use the Receiver

The Receiver can directly detect a signal on a wire through walls, floors, ceilings, and non-metallic conduit or pipe. To indirectly trace a wire in non-metallic conduit or pipe, use conductive fish tape or wire. See [Conductive Fish Tape or Wire Method](#). The Receiver cannot directly detect a signal on a wire through metallic conduit or pipe. Use the junction box method to indirectly trace wires in metallic conduit. See [Junction Box Method](#).

To use the Receiver:

1. Connect and set up the Transmitter in high mode unless otherwise noted.
2. Turn on the Receiver.

*Note*

*Keep the Receiver >1 m (3 ft) from the Transmitter and test leads to minimize signal interference.*









3. If needed, open the settings screen to select the language, brightness of the screen, volume, and type of breaker (GFI or RCD). See [Change Settings](#).
4. If needed, select a mode. [Table 8](#) lists the trace modes and describes the applications for each mode.
  - a. On the 2052R receiver, push .
  - b. On the 2062R receiver, see [Change the Trace Mode](#).

Table 8. Trace Modes

Mode	Description
Smart Sensor <b>SMART SENSOR</b> (2062R)	Use with the Transmitter and the arrows on the display of the Receiver to see which way to move the Receiver to identify which wire connects to the Transmitter. See <a href="#">Smart Sensor Mode (2062R)</a> .
Quick scan  (2052R)	Use with the Transmitter to quickly identify the presence of a signal and to follow the path to the wire. Does not identify a specific wire or breaker. See <a href="#">Quick Scan Mode (2052R)</a> .
Tip sensor or precision  (2052R) <b>TIP SENSOR</b> (2062R)	Use with the Transmitter to identify which specific wire connects to the Transmitter. Use to identify a wire in a bundle or to trace a wire in corners, confined spaces such as junction boxes, or inside enclosures. Also use to trace low-voltage wires such as data, audio, and thermostat cables. See <a href="#">Tip Sensor Mode</a> .
Breaker  (2052R) <b>BREAKER</b> (2062R)	Use with the Transmitter to identify which fuse or breaker connects to the Transmitter. See <a href="#">Breaker Mode</a> .
Non-contact voltage (NCV)  (2052R)  (2062R)	Use without the Transmitter to identify the generalized presence of an energized wire (90 V ac to 600 V ac and 40 Hz to 400 Hz). No current flow is necessary.

5. To trace another wire in the same mode, push **+**.
6. To change to a different mode:
  - a. On the 2052R receiver, push .
  - b. On the 2062R receiver, push  to select a NCV test, or push  to return to the home screen to select another mode. See [Change the Trace Mode](#).

## Smart Sensor Mode (2062R)

With a wire detected, Smart Sensor mode automatically adjusts the sensitivity of the Receiver. The Receiver stores in memory the strongest signal detected. As a result, the Receiver prevents manual adjustment of the sensitivity level.

To use Smart Sensor mode:

1. Hold the Receiver with the Smart Sensor toward the target area. See [Figure 7](#).
2. Based on what shows on the display, move the Receiver to align with the wire. See [Table 9](#).

Figure 7. SMART SENSOR Mode

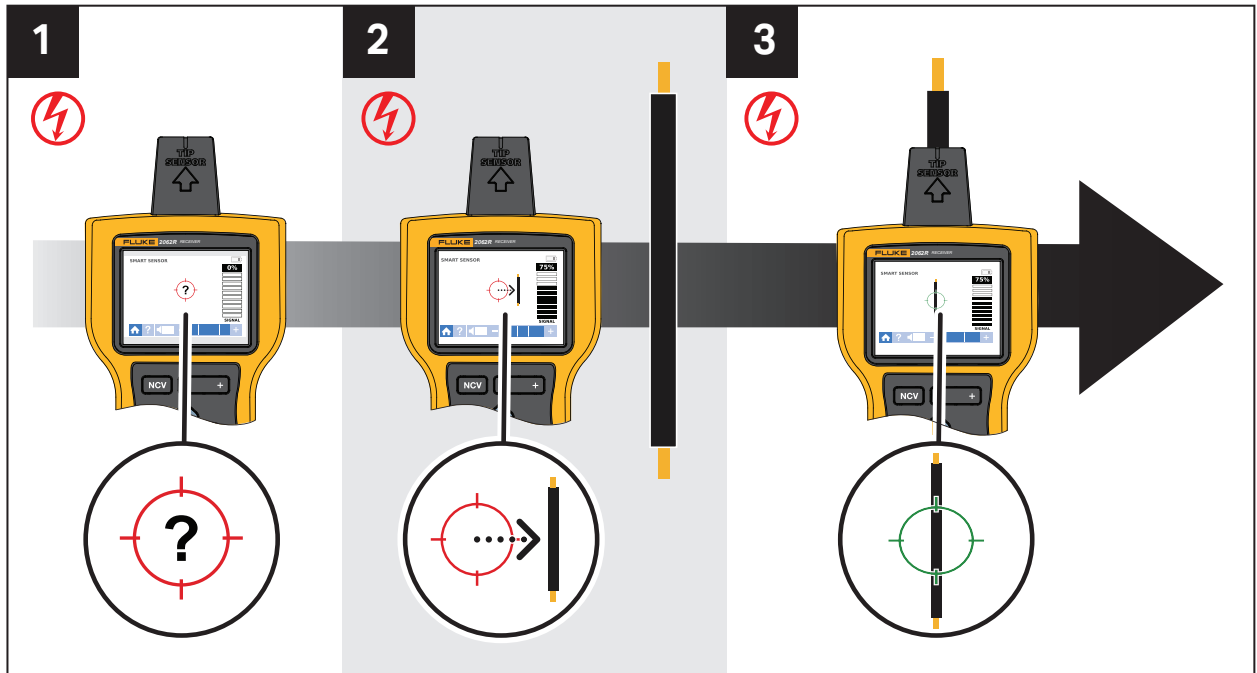





Table 9. SMART SENSOR Mode Display

Display	Description and Action
	<p>The Receiver cannot detect a signal or the signal is not strong enough for the Receiver to show where the wire is located.</p> <p>Move the Receiver closer to the target area.</p> <p>If a signal is still not detected, push <b>+</b> to increase the sensitivity.</p>
	<p>Move the Receiver in the direction indicated by the arrow: horizontally, vertically, or diagonally.</p>
	<p>The Receiver is directly over the wire.</p> <p>If the wire does not stay aligned with the green target, push <b>-</b> to decrease the sensitivity.</p> <p>If the wire still does not align with the target: On the Transmitter, push <b>Low</b> to generate a low signal to trace more precisely.</p>

## Quick Scan Mode (2052R)

To use quick scan mode:

1. Scan a target area with the tip sensor to find a signal.

The signal strength indicator on the display changes. See [Figure 8](#).

**Figure 8. Quick Scan Signal Strength**

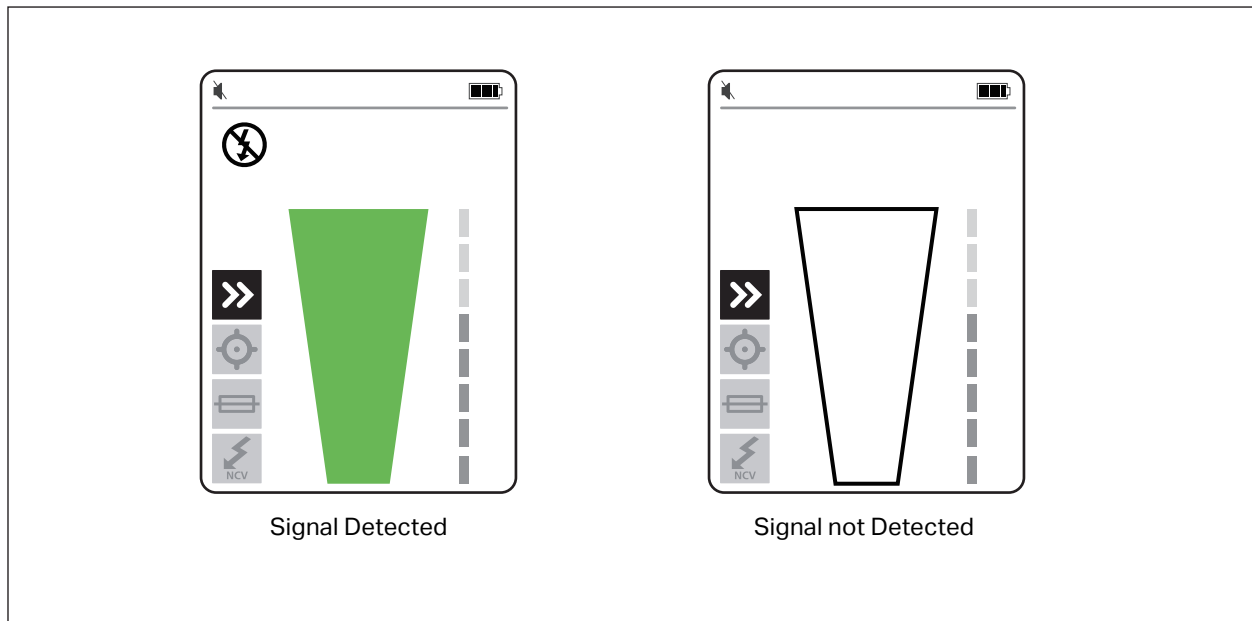

2. If needed, push **+/-** to increase or decrease the sensitivity to locate the signal.
3. With the signal detected, change to precision mode or breaker mode. See [Tip Sensor Mode](#).

## Tip Sensor Mode

To use tip sensor mode:

1. Scan a target area with the tip sensor to find the highest signal level.
2. With a wire detected, align the tip sensor perpendicular to the wire to find the highest signal level. Align the groove on the top of the tip sensor parallel to the wire. See [Figure 9](#).
3. To verify the direction of the wire, periodically rotate the Receiver 90 degrees from side to side while the tip sensor remains perpendicular to the wire.

Figure 9. Tip Sensor Alignment

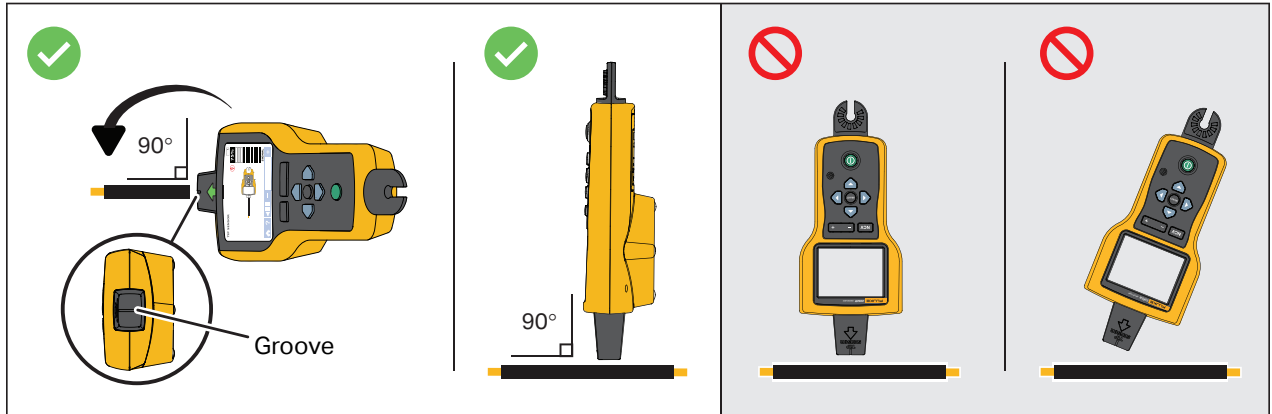

4. Periodically adjust the sensitivity to keep the signal strength near 75 %.

The signal strength indicator on the display changes. For the 2052R display, see [Figure 10](#). For the 2062R display, see [Figure 11](#).

5. If the signal is too strong to precisely locate the wire, change the Transmitter to low mode.

Figure 10. Tip Sensor Signal Strength (2052R)



Figure 11. Tip Sensor Signal Strength (2062R)

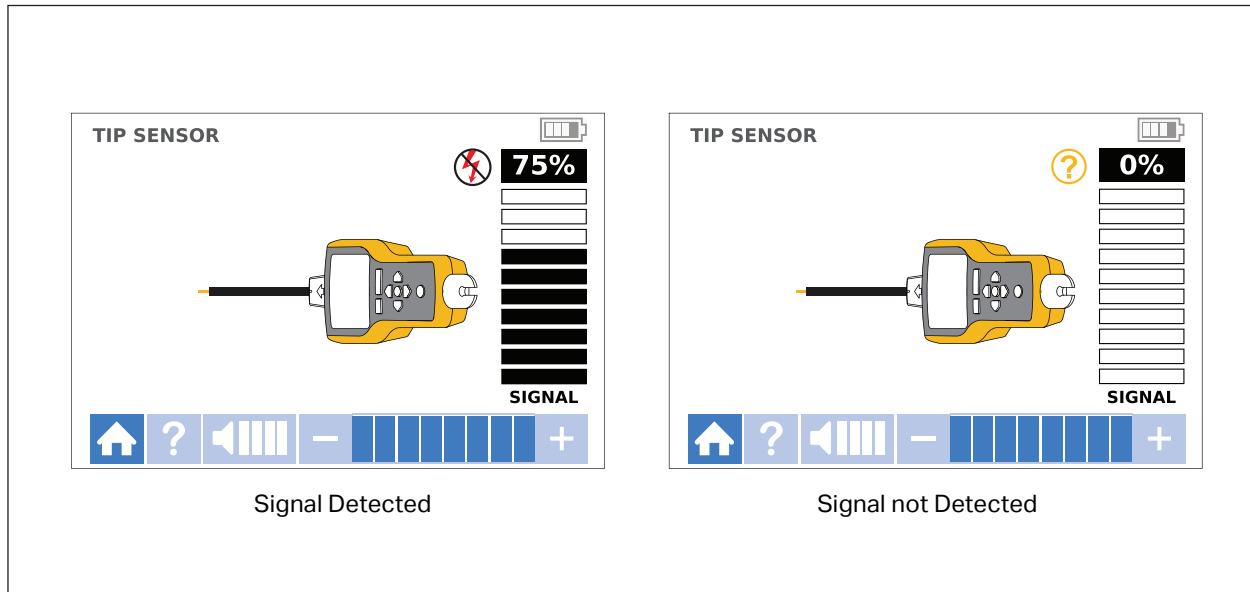

## Breaker Mode

Breaker mode automatically adjusts the sensitivity of the Receiver. The Receiver stores in memory the strongest signal detected. As a result, the Receiver identifies one correct breaker.

To use breaker mode:

1. To trace a breaker or fuse on a circuit with a light dimmer, turn off the light switch to prevent multi-frequency signals on the wire.
2. Align the tip sensor perpendicular to the breaker. The groove on the top of the tip sensor aligns parallel to the breakers. See [Figure 12](#).

### Note

*Different breaker or fuse designs, height, or internal contact structure may affect the precision of breaker or fuse identification. For best results, remove the breaker or fuse panel cover, and do the scan on the wires instead of the breakers or fuses.*

Figure 12. Breaker Mode Alignment

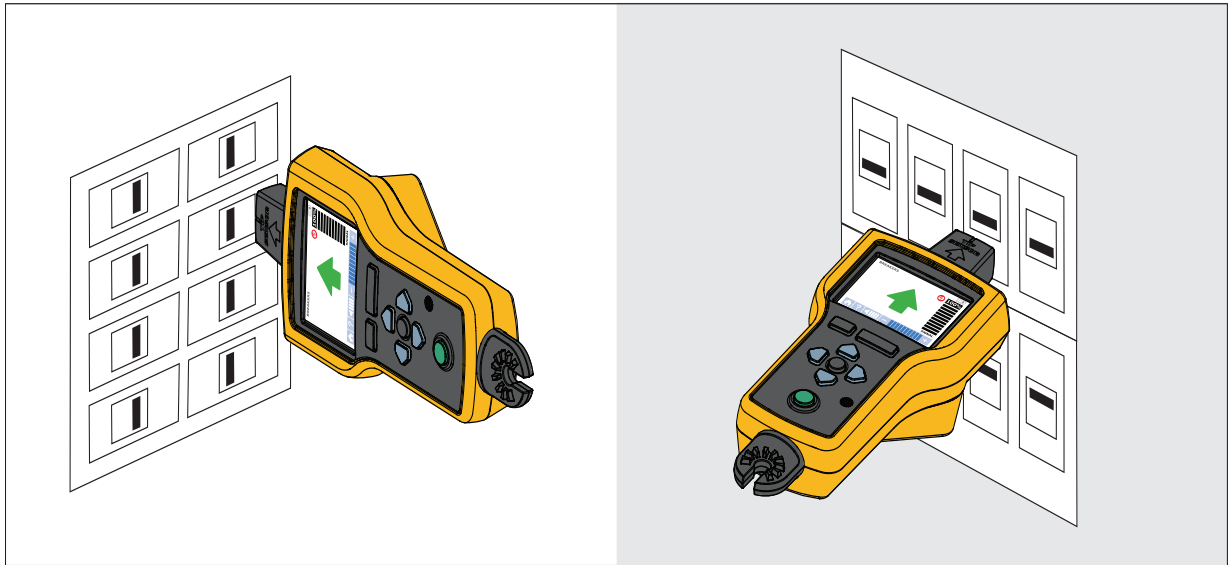

3. Scan each breaker or fuse multiple times until the arrow on the display shows solid green for only one breaker or fuse. For best results, scan at the output of the breaker or fuse. The order you scan the breakers or fuses does not matter.

The signal strength indicator on the display changes. For the 2052R display, see [Figure 13](#). For the 2062R display, see [Figure 14](#). For a breaker mode application, see [Figure 15](#).

Figure 13. Breaker Signal Strength (2052R)

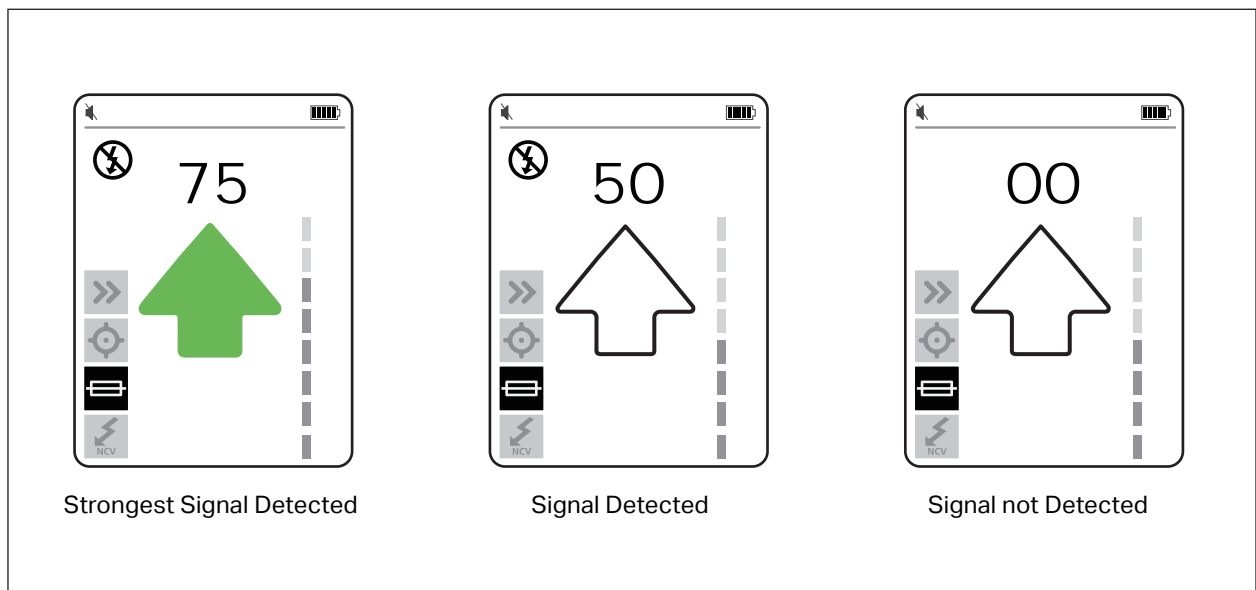

Figure 14. Breaker Signal Strength (2062R)

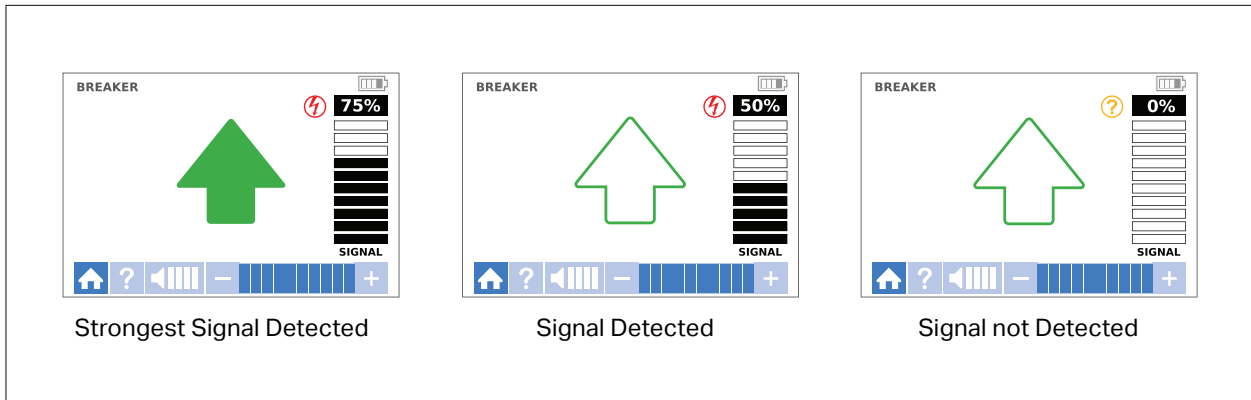
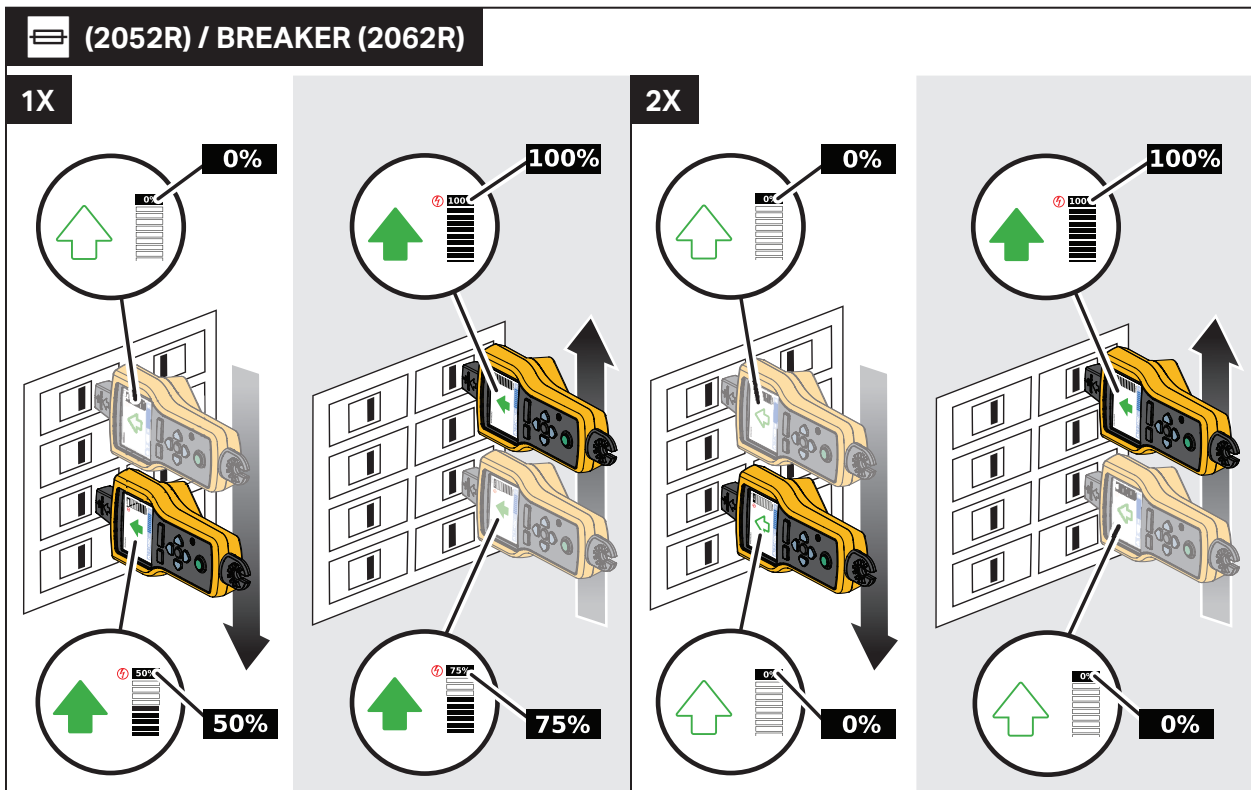

Figure 15. Breaker Mode Application





## NCV Mode

### ⚠⚠ Warning

**The voltage indication in NCV mode does not indicate the absence of voltage. Always verify that wires are de-energized with an additional tester.**

To use NCV mode:

1. Scan a target area with the tip sensor to find the highest signal level.
2. With a wire detected, align the tip sensor perpendicular to the wire to find the highest signal level. The groove on the top of the tip sensor aligns parallel to the wire. See [Figure 9](#).
3. Periodically adjust the sensitivity to keep the signal strength near 75 %.

The signal strength indicator on the display changes. For the 2052R display, see [Figure 16](#). For the 2062R display, see [Figure 17](#).

4. To identify the line or phase wire from the neutral wire, increase or decrease the sensitivity.

**Figure 16. NCV Signal Strength (2052R)**

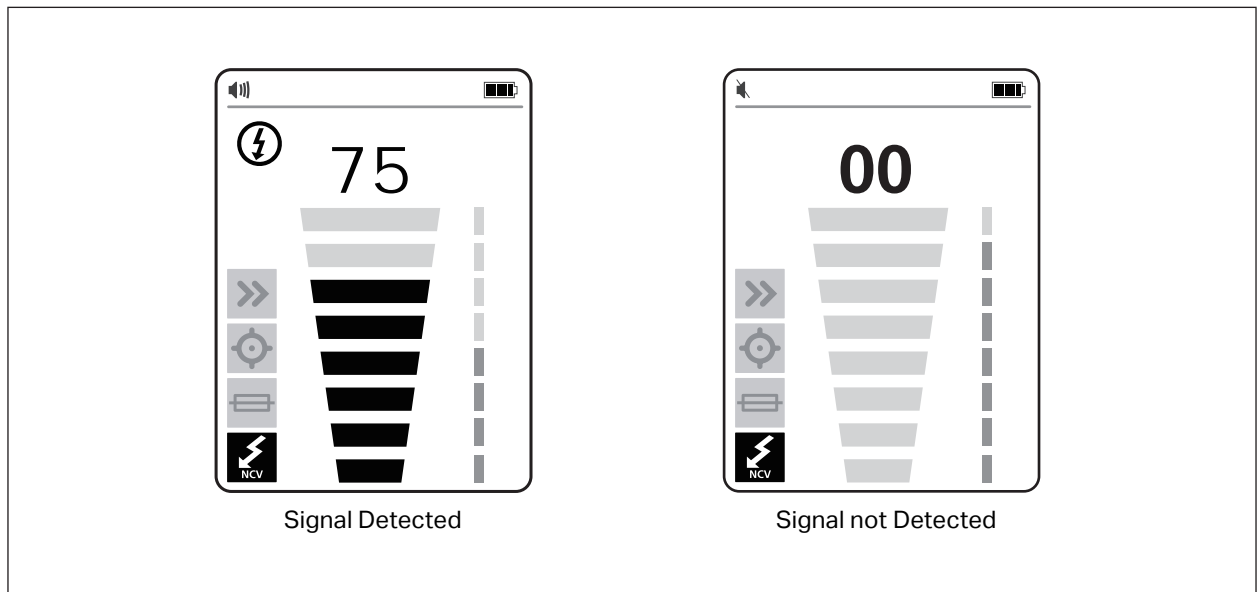
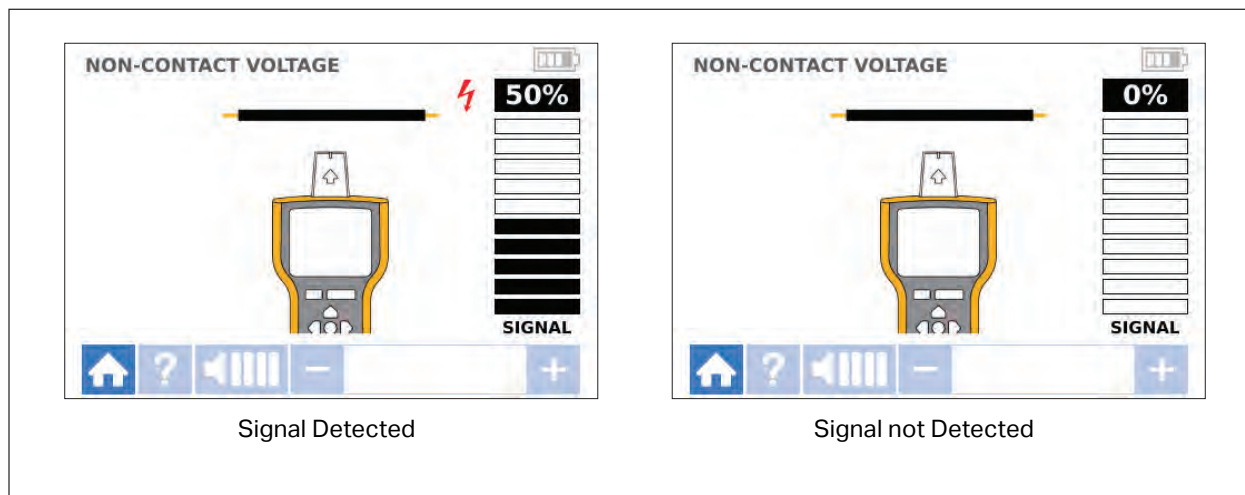

Figure 17. NCV Signal Strength (2062R)



## Special Applications

For general instructions to connect the Transmitter, see [Connect the Transmitter](#). Some applications require the test leads to connect differently. For all applications, connect the Transmitter on what would be the load-side of an energized circuit whether or not a circuit is energized or de-energized.

### Find a Broken or Open Wire

The signal generated by the Transmitter conducts along the wire while there is continuity in the metal conductor.

*Note*

*Natural materials in the earth, concrete, or asphalt and buried metal conduits can make it difficult to trace a wire located underground.*

To find the location of a broken wire located behind walls, floors, or ceilings:

1. De-energize the wire.
2. Connect the Transmitter to the circuit. See [Figure 18](#).
  - a. Connect the red test lead to the circuit.
  - b. Connect the black stackable test lead to the Transmitter.
  - c. Connect one end of the green test lead to the black test lead and the other end to a separate ground.
  - d. Connect additional test leads as needed to ground all unused de-energized wires on the Transmitter side of the circuit that run in parallel with the black test lead.

**Figure 18. Trace a Broken Wire**

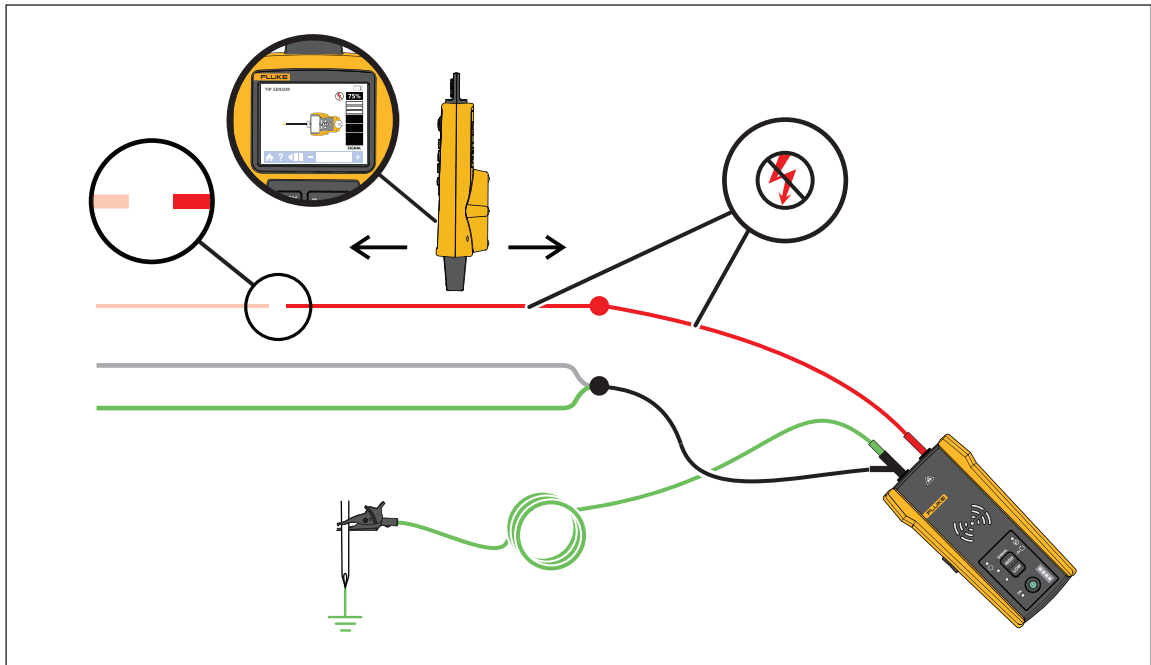

3. On the Receiver, select Smart Sensor mode or tip sensor mode.
4. Trace the wire until the signal stops.
5. Mark the location where the signal stops.

6. Verify the location of the broken wire.
  - a. Move the Transmitter to the other end of the wire.
  - b. Trace from the opposite end of the wire to the location the signal stopped in the previous step.

*Note*

*The Receiver may not detect a break in a wire in a high-resistance break which is a partially-open circuit. A high-resistance break stops the flow of higher-level currents but still conducts the signal through the break. Until the break in the wire is completely open, the Receiver may not detect the location of the broken wire.*

## Find a Short in a Circuit

When wires in a circuit touch, they cause a short in the circuit which causes the breaker or fuse to trip or turn off.

To correct a short in a circuit:

1. Disconnect the wires.
2. Isolate the ends of the wire on both sides of the cable so that they do not touch each other or other wires or loads.

To find the location of a short in a circuit:

1. Disconnect the wires.
2. Connect the Transmitter to the ground wire on the same circuit as the hot wire. See [Figure 19](#).

*Note*

*The signal may be weak and difficult to detect due to the cancellation effect. See [Connect the Transmitter](#).*

Figure 19. Trace a Short Circuit

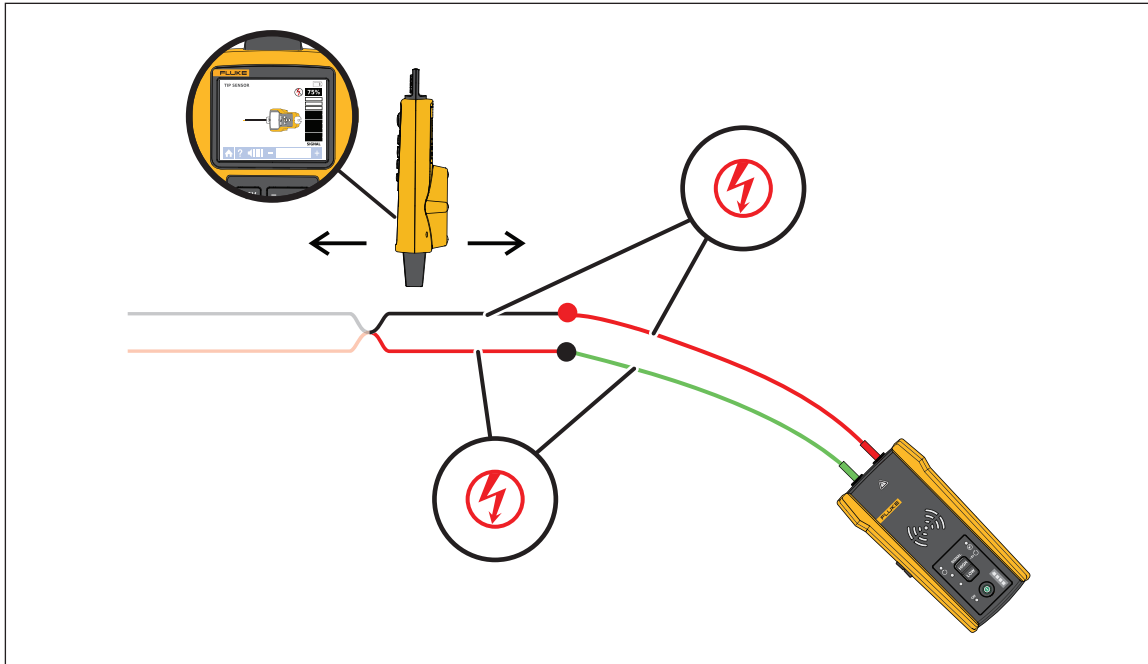

3. On the Transmitter, select loop mode.
4. On the Receiver, select tip sensor mode.
5. Trace the wire until the signal stops.
6. Mark the location where the signal stops.
7. Verify the location of the short in the wire.
  - a. Move the Transmitter to the other end of the wire.
  - b. Trace from the opposite end of the wire to the location the signal stopped in the previous step.

## Trace Wires in Conduit or Pipe

You can use one of the alternative methods to trace a wire inside a conduit or pipe.

### Junction Box Method

To use the junction box method to trace a wire inside conduit or pipe:

1. Connect the Transmitter.
2. On the Receiver, select tip sensor mode.
3. Open the closest junction box that is to the Transmitter.
4. Use the tip sensor to identify which wire in the junction box carries the signal.
5. Move from junction box to junction box to follow the path of the wire.

### Conductive Fish Tape or Wire Method

To use conductive fish tape to trace a wire inside non-metallic conduit or pipe:

1. Insert conductive fish tape or wire inside the conduit.
2. Connect the Transmitter.
  - a. Connect the red test lead to the conductive fish tape or wire.
  - b. Connect the green test lead to a separate ground.
3. On the Receiver, select tip sensor mode to trace the conduit or pipe.

The Receiver detects the signal the fish tape or wire conducts through the conduit or pipe.

## Trace a Shielded Wire

To trace a shielded wire:

1. Disconnect the ground on the near-end of the shielded wire.
2. Connect the Transmitter. With a wire grounded at the far-end, see [Figure 20 A](#). With the wire not grounded at the far-end, see [Figure 20 B](#).
  - a. Connect one end of a test lead to the shield on the wire and the other end to the Transmitter (polarity does not matter).
  - b. Connect one end of the second test lead to the Transmitter and the other end to a separate ground.

Figure 20. Trace a Shielded Wire

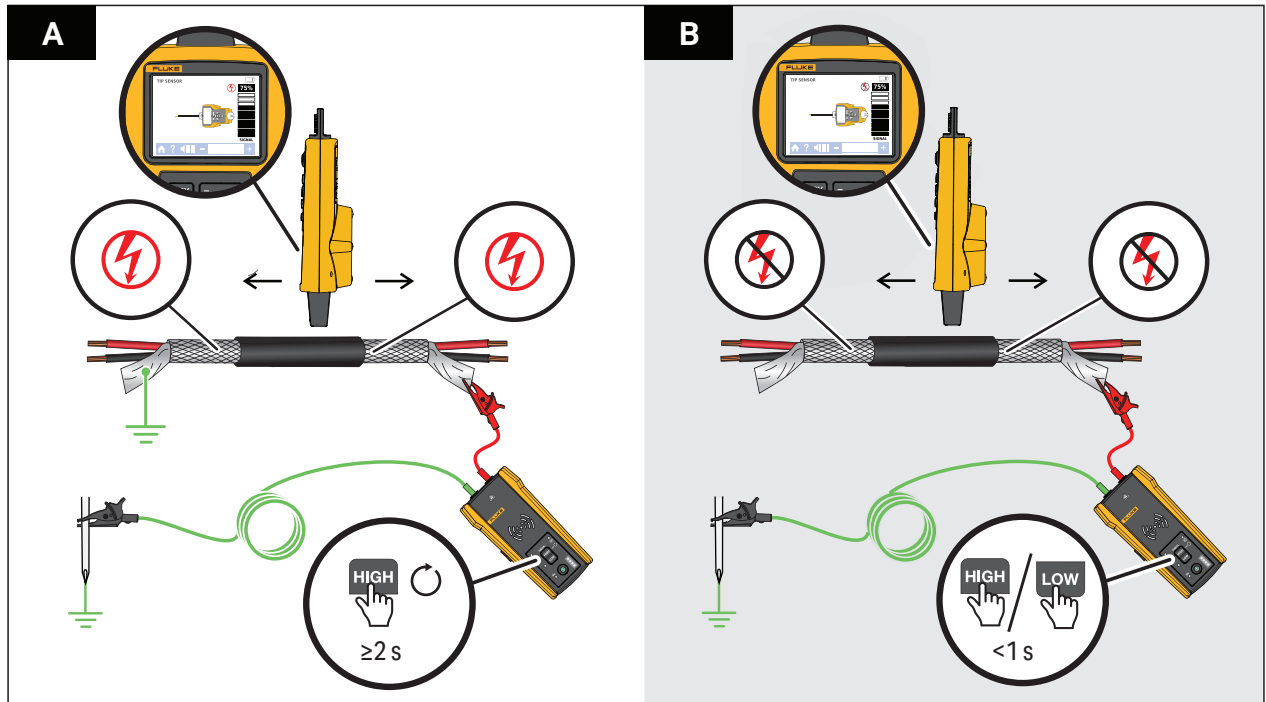

3. On the Transmitter:

With a wire grounded at the far-end, select loop mode. See [Figure 20 A](#). The loop mode LED lights.

Or,

With a wire not grounded at the far-end, select high or low mode. See [Figure 20 B](#). The high or low mode LED lights.

4. On the Receiver, select tip sensor mode to trace the wire.

## Find a Wire in a Bundle

To identify a wire in a bundle, first determine if the wire is on an energized or de-energized circuit.

### De-energized Circuit

To identify a wire in a bundle in a de-energized circuit:

1. Connect the Transmitter. See [Figure 21](#).
  - a. Connect the red test lead to the circuit.
  - b. Connect the black stackable test lead to the Transmitter.
  - c. Connect one end of the green test lead to the black test lead and the other end to a separate ground.
  - d. Connect additional test leads as needed to ground all unused de-energized wires on the Transmitter side of the circuit that run in parallel with the black test lead.
2. On the Receiver, select tip sensor mode.
3. Pull one wire out as far as possible from other wires in the bundle and touch it with the tip sensor. The strongest signal indicates the proper wire in the bundle.

**Figure 21. Trace a Bundled Wire in a De-energized Circuit**

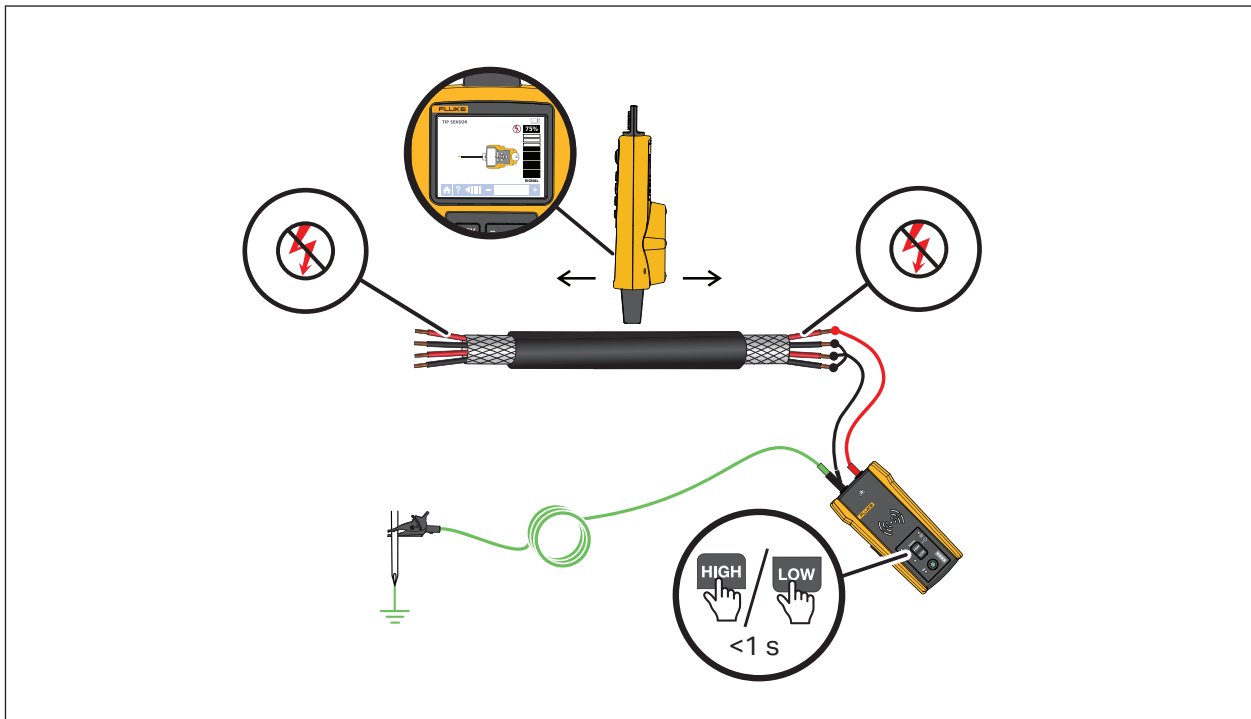



## Energized Circuit

To identify a wire in a bundle in an energized circuit:

1. Connect the Transmitter. See [Figure 21](#).
  - a. Connect the red test lead to the circuit.
  - b. Connect the green test lead to a separate ground.
2. On the Receiver, select tip sensor mode.
3. Pull one wire out as far as possible from other wires in the bundle and touch it with the tip sensor. The strongest signal indicates the proper wire in the bundle.

**Figure 22. Trace a Bundled Wire in an Energized Circuit**

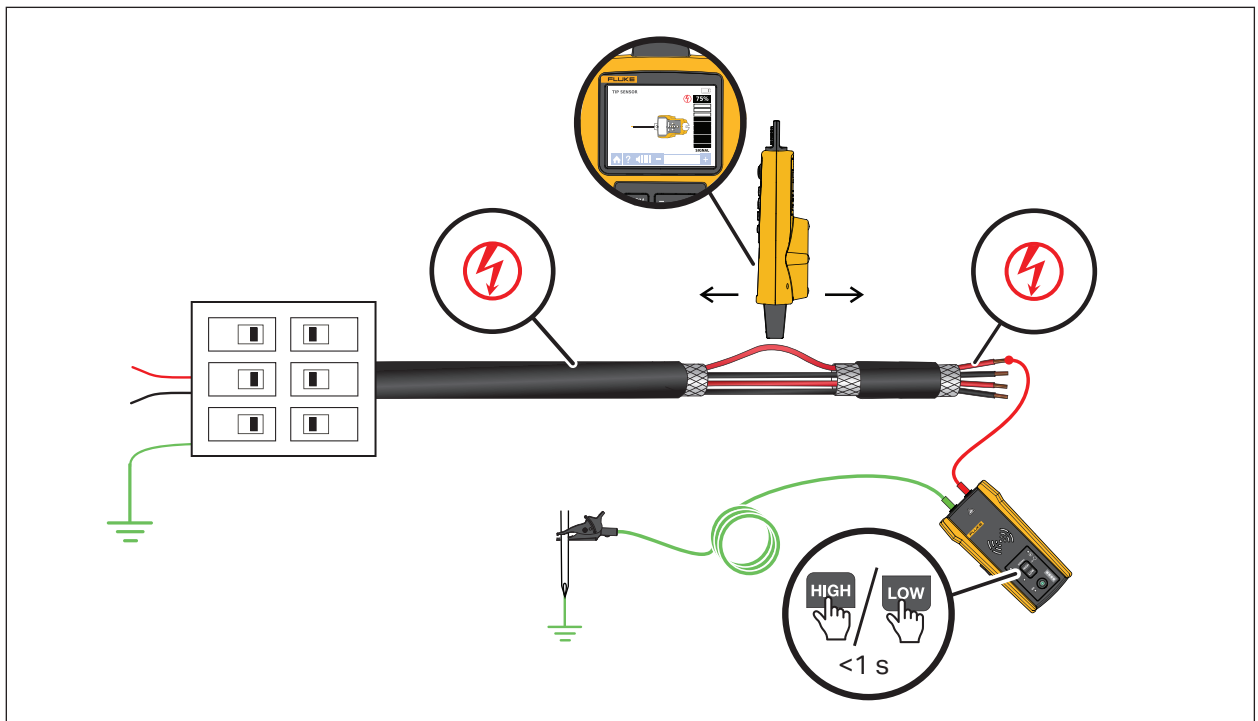

## Map a Circuit

Use test leads or the Clamp to map a de-energized circuit. Use the Clamp to map an energized circuit.

### Test Leads

To use test leads to map a de-energized circuit:

1. Turn off the breaker or fuse.
2. Connect the Transmitter. See [Figure 23](#).
3. On the Receiver, select tip sensor mode.
4. Scan the face plates of receptacles and wires towards the load with the tip sensor of the Receiver.

The receptacles and loads that are connected to the breaker or fuse show a strong signal on the Receiver.

### The Clamp

To use the Clamp to map an energized or de-energized circuit:

1. Connect the Clamp around the wire at the breaker or fuse panel. See [Figure 24](#).
2. On the Receiver, select tip sensor mode.
3. Scan the face plates of receptacles and wires towards the load with the tip sensor of the Receiver.

The receptacles and loads that are connected to the breaker or fuse show a strong signal on the Receiver.

Figure 23. Map a Circuit with Test Leads

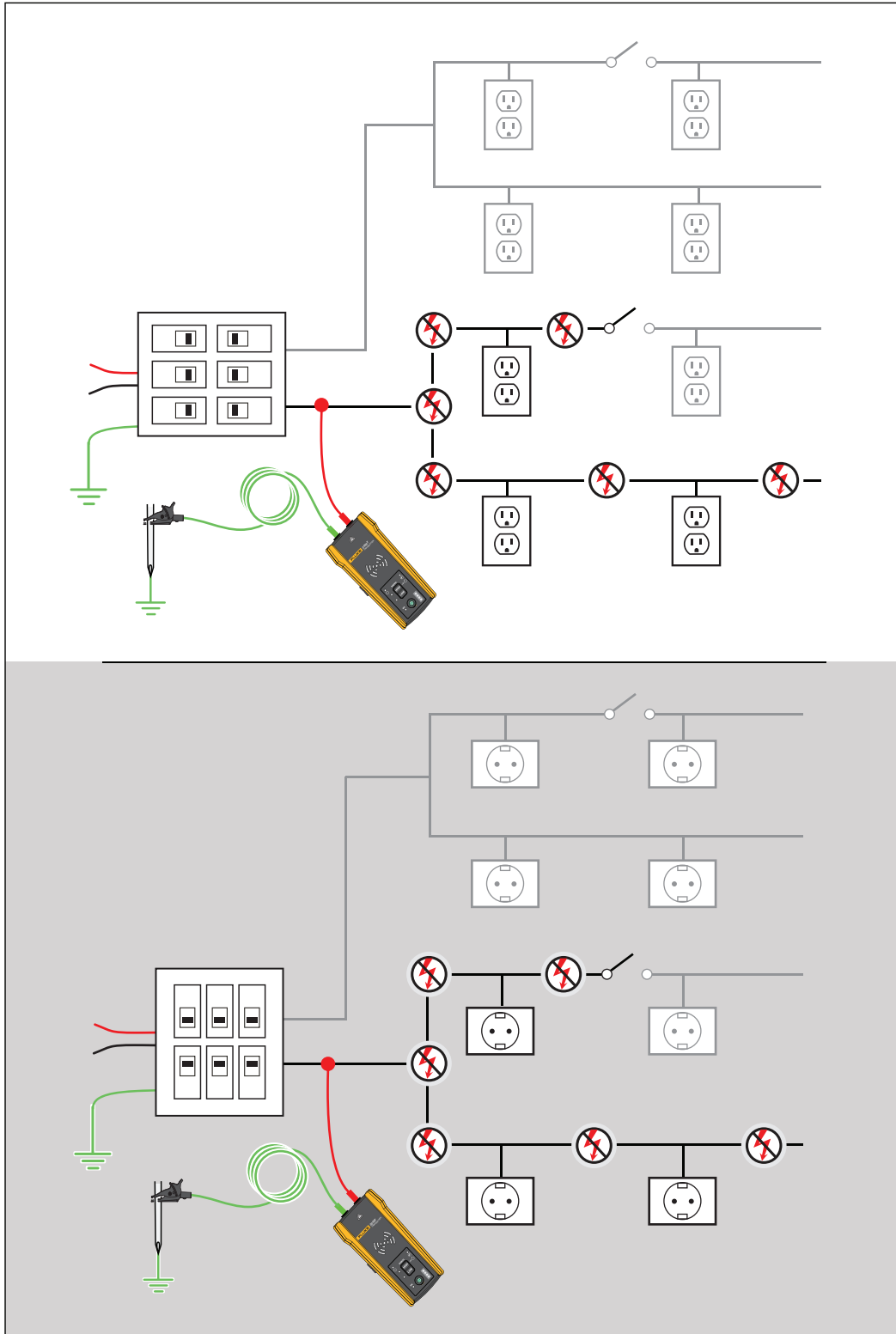
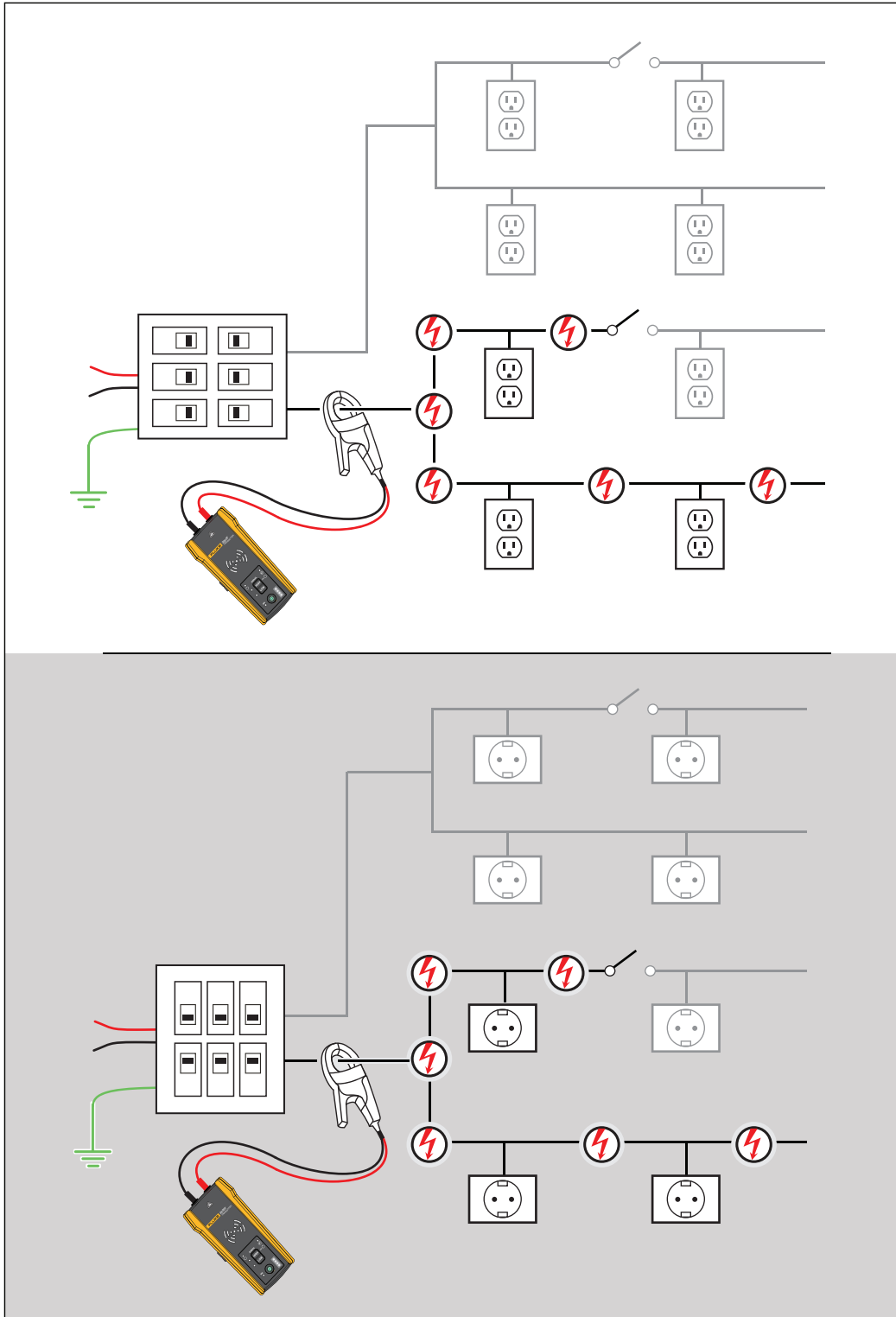

Figure 24. Map a Circuit with the Clamp



## Maintenance

The Product requires little maintenance.

### Warning

To prevent possible electrical shock, fire, or personal injury:

- Use only specified replacement parts.
- Use only specified replacement fuses.
- Have an approved technician repair the Product.
- Do not use the Product if it is altered or damaged.
- Examine the case before you use the Product. Look for cracks or missing plastic. Carefully look at the insulation around the terminals.
- Do not apply more than the rated voltage, between the terminals or between each terminal and earth ground.
- Batteries contain hazardous chemicals that can cause burns or explode. If exposure to chemicals occurs, clean with water and get medical aid.
- Repair the Product before use if the battery leaks.
- Battery leakage may create a shock hazard or damage the Product.
- Remove the batteries if the Product is not used for an extended period of time, or if stored in temperatures above 50 °C. If the batteries are not removed, battery leakage may result.
- The battery door must be closed and locked before you operate the Product.
- Be sure that the battery polarity is correct to prevent battery leakage.
- Do not put battery cells and battery packs near heat or fire. Do not put in sunlight.
- Remove all probes, test leads, and accessories before the battery door is opened.

## Clean the Product

Periodically wipe the case with a damp cloth and mild detergent. Do not use abrasives or solvents. Dirt or moisture in the terminals can affect readings.

## Receiver Battery Replacement

Use alkaline or rechargeable NiMH batteries. Batteries do not come installed in the Receiver. To charge NiMH batteries, remove from the batteries from the Receiver.

To install or replace the batteries in the Receiver, turn off the Receiver and install new batteries with the correct polarity. See [Figure 25](#).

**Figure 25. Receiver Battery Replacement**

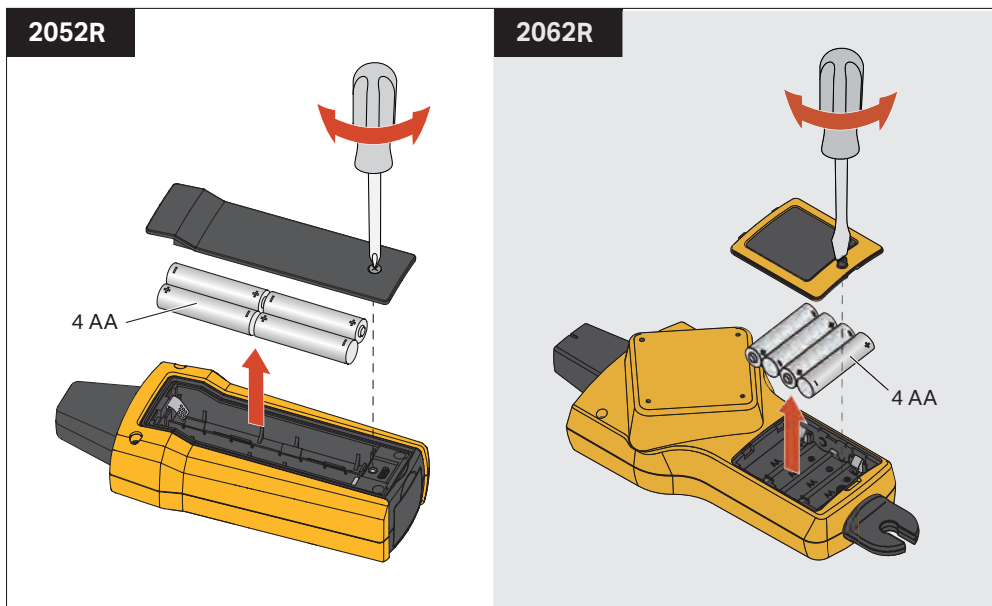

## Transmitter Battery Replacement

Alkaline batteries ship with the Product. If desired, use NiMH rechargeable batteries in the Transmitter. Batteries do not come installed in the Transmitter. To charge NiMH batteries, remove the batteries from the Transmitter.

To install or replace the batteries in the Transmitter, turn off and disconnect the Transmitter from the circuit and install new batteries with the correct polarity. See [Figure 26](#). With new batteries installed, set the battery type. See [Battery Type Selection \(2000T, 2052R\)](#).

Figure 26. Transmitter Battery and Fuse Replacement

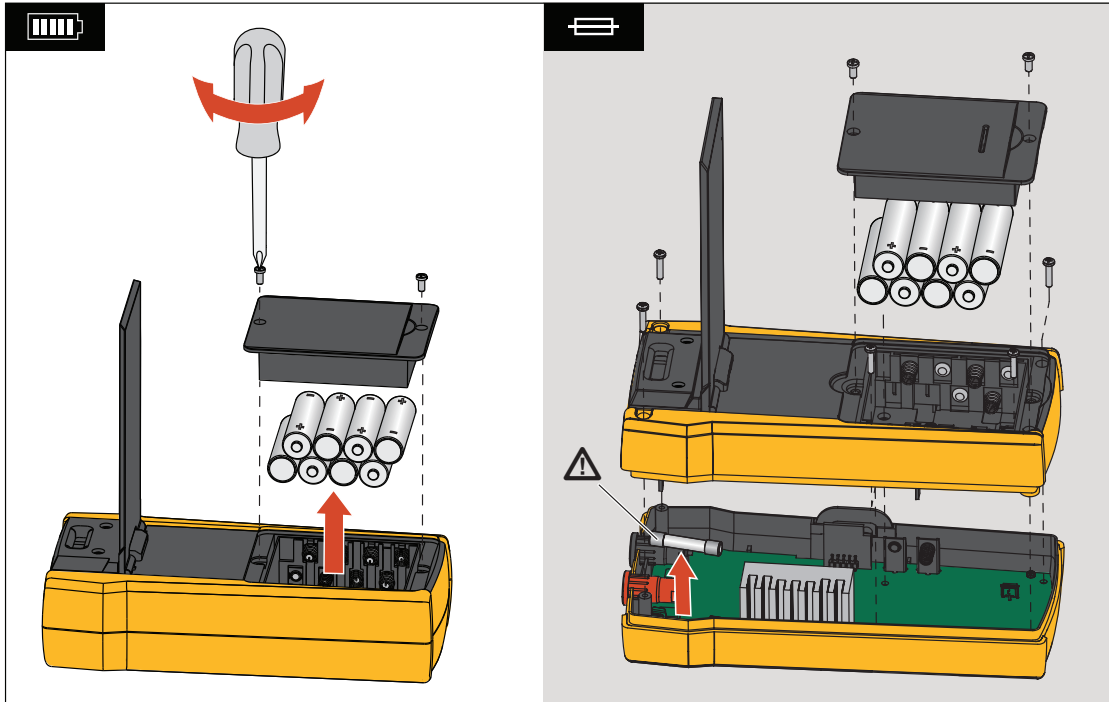

## Battery Type Selection (2000T, 2052R)

If the battery type is not defined manually, the Product automatically sets the type to alkaline or NiMH. Automatic battery type recognition draws more current and may be unreliable when batteries do not contain an adequate charge. To increase the reliability of automatic battery detection, use new batteries or charge NiMH batteries regularly. For best results, set the battery type manually.

To manually set the battery type as alkaline:

1. Turn off the Product.
2. Push and hold the volume  $\oplus$  button and  $\textcircled{1}$  simultaneously.

To manually set the battery type as NiMH:

1. Turn off the Product.
2. Push and hold the volume  $\ominus$  button and  $\textcircled{1}$  simultaneously.

## Transmitter Fuse Replacement

To install or replace the fuse in the Transmitter (See [Figure 26](#)):

1. Turn off and disconnect the Transmitter from the circuit.
2. Remove the tilt stand screw.
3. Remove the battery compartment screws, the battery cover, and batteries.
4. Remove the screws in the back cover.
5. Pull up on the back cover to remove the cover.
6. Remove the fuse from the fuse holder.
7. Insert the new fuse (1 A, 700 V, fast-acting, 6 mm x 32 mm, 50 kA interrupt rating) in the fuse holder.
8. Replace and secure the back cover, the batteries, the battery cover, and the tilt stand.

## Product Disposal

Dispose of the Product in a professional and environmentally sound manner:

- Delete personal data on the Product before disposal.
- Remove batteries that are not integrated into the electrical system before disposal and dispose of batteries separately.
- If this Product has an integral battery, put the entire Product in the electrical waste.

## Specifications

For the complete product specifications, see our website.