

Fieldpiece

Compact Clamp Meters

OPERATOR'S MANUAL

Models SC260
SC240 SC220

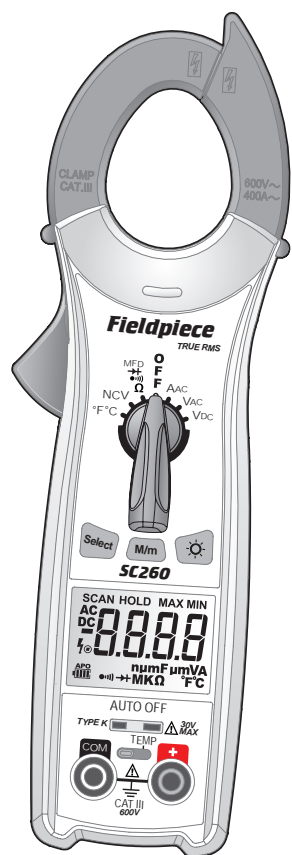

Quick Start

1. For electrical testing, connect test leads to "COM" and "+" jacks.
2. Rotate the dial to your desired measurement.
3. Connect to test points and read measurement.
4. For temperature testing, remove test leads, slide TEMP switch to the right and connect Type K thermocouple (SC240/SC260 only).

Certifications

UL 61010-1, Third Edition

EN61010-1
EN61010-2-032
EN61010-2-033
EMC EN61326-1

C-Tick (N22675)

WEEE

CATIII 600V, class II and pollution degree 2 indoor use comply with CE, RoHS compliant.

CATIII is for measurements performed in the building installation.

Description

The new SC200 series compact clamp meters are designed for everyday HVACR service. Their compact pocketable design makes them easy to take on any job.

Hang the SC260 to any metallic surface with its newly designed swivel magnet to keep your hands free to do more. Test variable frequency drives more accurately with True RMS and easily see your measurements in low lighting with the bright blue backlight (SC260 only).

Save time with the new Auto Select mode. Simply set the dial to (Ω/•••)/→/MFD and connect your leads. Your meter will automatically select the appropriate measurement depending on what it detects. Move from a cold freezer to a hot rooftop and get accurate temperature measurements that lesser thermometers cannot measure properly (SC240/SC260 only).

Test for proper flame rectification micro amp DC current on heating systems (SC220 only).

All SC200 compact clamp meters are built to withstand the rigors of HVACR service with high impact plastic and a display you can read in very hot or very cold environments.

Controls

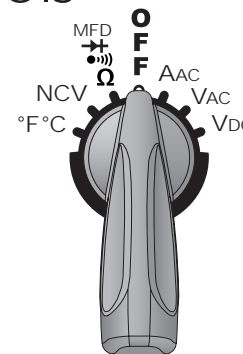

Rotate dial to the function you want to use.

Select a parameter. Ohms/Continuity/Diode/MFD. °F/°C (SC240/260 only).

Toggle backlight (SC260 only).

Freeze maximum and minimum reading. Hold for 1 second to clear. (SC240/SC260 only)

Manually select a range (SC220/240).

Freeze the display.

Display

- Battery Life (replace 9V if blinking)
- Auto Power Off Enabled
- High Voltage Warning (>16VAC/35VDC)
- Manual Range (Range) Mode
- Maximum Reading
- Minimum Reading
- Data Hold Mode
- Auto Select Mode (Ω/•••)/→/MFD)
- Continuity Test
- Diode Test
- Resistance Test (ohms)
- Capacitance Test (farads)
- Nano Unit (10⁻⁹, one billionth)
- Micro Unit (10⁻⁶, one millionth)
- Milli Unit (10⁻³, one thousandth)
- Kilo Unit (10³, one thousand)
- Mega Unit (10⁶, one million)

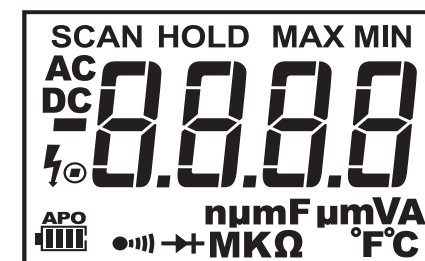

Safety Information

Never ground yourself when taking electrical measurements. Do not touch exposed metal pipes, outlets, fixtures, etc., which might be at ground potential, while taking measurements. Keep your body isolated from ground by using dry clothing, rubber shoes, rubber mats, or any approved insulating material.

Disconnect the test leads before opening the case. Inspect the test leads for damage to the insulation or exposed wire. Replace if suspect. Keep your fingers behind the finger guards on the probes while taking measurements.

When disconnecting from a circuit, disconnect the "RED" lead first, then the common "BLACK" lead. Use one handed testing when possible. Work with others.

Turn off power to the circuit under test before cutting, unsoldering, or breaking the circuit.

Do not measure resistance (ohms) when circuit is powered. Isolate load by disconnecting from circuit.

Disconnect the meter from circuit before turning any inductor off, including motors, transformers, and solenoids. High voltage transients can damage the meter beyond repair.

Do not use during electrical storms.

Do not apply more than rated voltages between input and ground.

Isolate capacitors from system and discharge them safely before testing.

Temperature switch prevents leaving thermocouple plugged in while measuring voltage.

When measuring high frequency AC current, do not exceed the rated 400AAC of the clamp. Failure to adhere may cause the clamp to heat up dangerously.

All voltage tests: All voltage ranges will withstand up to 600V. Do not apply more than 600VDC or AC rms.

Symbols used:

- Caution, risk of electric shock
- Caution, refer to manual.
- Ground
- Double insulation

⚠ WARNINGS

DISCONNECT AND UNPLUG TEST LEADS before opening case.
TEST NCV FUNCTION ON KNOWN LIVE WIRE before using.
DO NOT APPLY VOLTAGE greater than 30VAC or 60VDC to the thermocouple or the jacks when the rotary dial is on °F/°C. (Use only Type K thermocouples)
DO NOT APPLY VOLTAGE TO THE JACKS when the rotary dial is on microamps. Even low voltages can cause a current overload and potentially harm the meter.

Specifications

Display: 4000 count

Backlight: 5 minute duration with auto-off. Blue color. SC260 only

Overrange: (OL) or (-OL) is displayed

Measurement rate: 3 times per second, nominal

Zero: Automatic

Operating environment: 32°F to 122°F (0°C to 50°C) at <70% relative humidity

Storage temperature: -4°F to 140°F (-20°C to 60°C), 0 to 80% RH (with battery removed)

Accuracy: Stated accuracy @ 73°F±9°F (23°C±5°C), <75%RH

Temperature coefficient: 0.1 x (specified accuracy) per °C [0°C to 19°C (32°F to 66°F), 28°C to 50°C (82°F to 122°F)]

APO (Auto Power Off): Approx. 30 minutes

Power: 9V, NEDA 1604A, IEC 6LR61 9V alkaline battery

Battery life: 200 hours typical alkaline (SC220/SC240); 150 hours typical alkaline (SC260)

Low battery indication: Battery icon blinks and "LO.b" is displayed when the battery voltage drops below the operating level

Dimensions: 205.5mm(H) x 67.4mm(W) x 45.1mm(D)

Weight: Approx. 265g including battery

Altitude: Up to 6562 ft (2000m)

Overload protection: 600VDC or 600VAC rms unless otherwise stated

Test leads: Use UL listed test leads that comply to UL61010-031 rated CATIII 600V or above. Included test leads are gold-plated and have removable safety caps.

Please operate the instrument following all instructions of the operator's manual to avoid impairing the safety of the product.

Functions

Temperature (°F/°C) SC240 and SC260 only

Plug any Type K thermocouple directly into the meter to measure temperature. Cold junction is located inside the meter and allows for extremely accurate measurements even in rapidly changing ambient temperatures (going from rooftop to freezer). No adapter is required. See Temp Calibration section for calibration instructions. Press SELECT button to switch between °F and °C.

Range: -30°F to 752°F, (-35°C to 400°C) **Resolution:** 0.1°

Accuracy: ±(1°F)* 32°F to 120°F, ±(1°C) 0°C to 49°C

±(1%+2°F) 32°F to 392°F, ±(1%+1°C) 0°C to 200°C

±(2%+6°F) -30°F to 32°F, ±(2%+3°C) -35°C to 0°C

±(2%+6°F) 392°F to 752°F, ±(2%+3°C) 200°C to 400°C

Sensor type: Type K thermocouple *After field calibration

Overload protection: 30 VDC or 30 VAC rms

Voltage DC (VDC)

Select VDC and measure DC voltages on circuit boards on more advanced HVACR systems.

Ranges: 4V, 40V, 400V, 600V **Resolution:** 0.001V

Accuracy: ±(0.5% + 2)

Input impedance: 10MΩ (4V), 9.1MΩ (40V-600V)

Voltage AC (VAC) (50Hz-500Hz)

Test power lines (120, 220, 480), test 24V going to controls, and test for transformer failure.

Ranges: 4V, 40V, 400V, 600V **Resolution:** 0.001V

Accuracy: ±(1.2% + 8), ±(1.5% + 8) on 600V range

True RMS: model SC260 only **Crest factor:** ≤ 3

Audio/Visual Hi-V indicator: >16VAC/35VDC

Input impedance: 10MΩ (4V), 9.1MΩ (40V-600V)

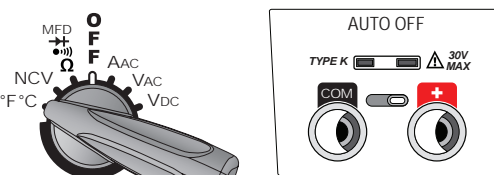

Unplug Leads and Slide TEMP Switch to the Right

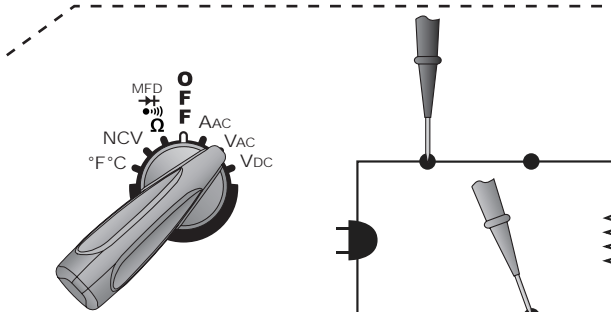
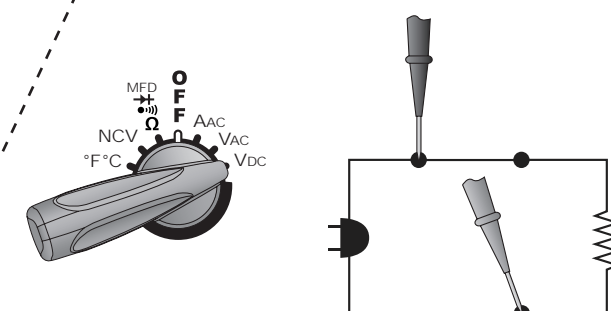

Capacitance (MFD) SC240 and SC260 only

Start and run capacitors are one of the most failure prone components in a HVACR system. Disconnect from power and resistors between terminals. Discharge capacitor before testing. If dI.S.C is displayed, capacitor is not fully discharged. Set to Ω / \bullet / \rightarrow / MFD to test capacitance of motor start and run capacitors or press SELECT three times to manually select MFD.

Ranges: 4nF, 40nF, 400nF, 4 μ F, 40 μ F, 400 μ F, 4mF **Resolution:** 1pF
Accuracy: $\pm(3\% + 20)$ 4nF, $\pm(3\% + 5)$ 40nF to 400 μ F, $\pm(5\% + 20)$ 4mF

Auto Select Ranges: 4nF to 400 μ F, >500pF

Overload Protection: 600VDC or 600VAC rms

Resistance (Ω)

Used for "ohming out" a compressor. 0.01 Ω resolution is useful to test the resistance between the motor poles because the values are typically very low.

Ranges: 40 Ω , 400 Ω , 4k Ω , 40k Ω , 400k Ω , 4M Ω , 40M Ω

Resolution: 0.01 Ω

Accuracy: $\pm(1.0\% + 15)$ 40 Ω , $\pm(1.0\% + 5)$ 400 Ω to 400k Ω ,

$\pm(1.5\% + 5)$ 4M Ω , $\pm(3.0\% + 5)$ 40M Ω

Auto Select Ranges: 4k Ω to 4M Ω , >400 Ω (SC240/SC260 only)

Overload Protection: 600VDC or 600VAC rms

Continuity (\bullet)

Set to Ω / \bullet / \rightarrow / MFD and measure continuity to test if a circuit is open or closed or press SELECT once to manually select continuity. Use this feature to check fuses as well. A steady "beep" and green LED indicate you have continuity.

Range: 400 Ω **Resolution:** 0.1 Ω **Response time:** 100ms

Audible beep: <30 Ω

Overload Protection: 600VDC or 600VAC rms

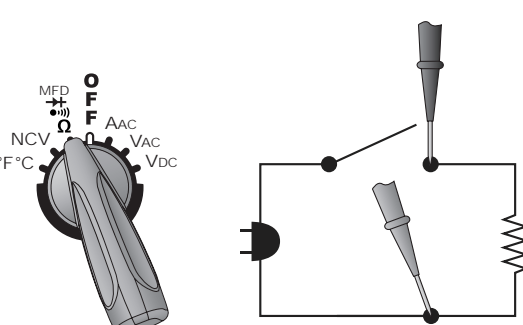
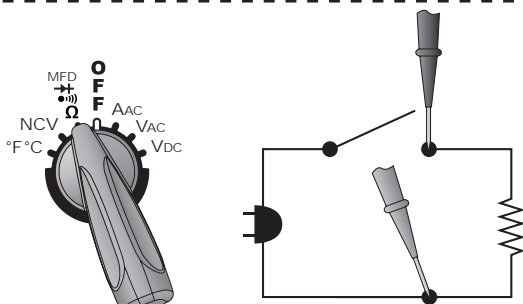
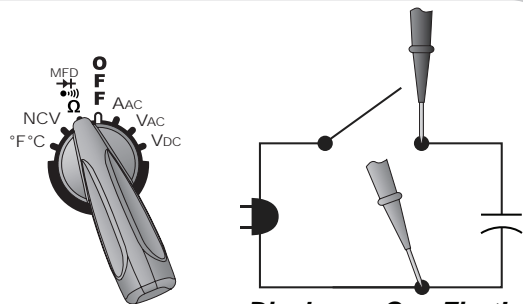

Diode Test (\rightarrow)

Set to Ω / \bullet / \rightarrow / MFD to test diodes for proper forward and reversed-biased functions. Press SELECT twice to manually select the diode test. A constant beep and green LED indicate continuity.

Test current: 1.0mA (Approx.) **Accuracy:** $\pm(1.5\% + 5)$

Open circuit volts: 3.2VDC typical

Visual indicator: Green LED **Audible beep:** <0.03V

Auto Select Threshold: Forward voltage drop <0.8V (SC240/SC260 only)

Overload Protection: 600VDC or 600VAC rms

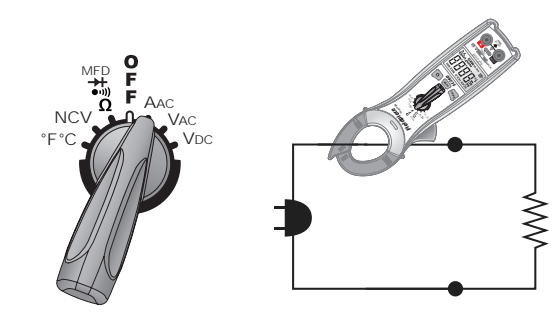
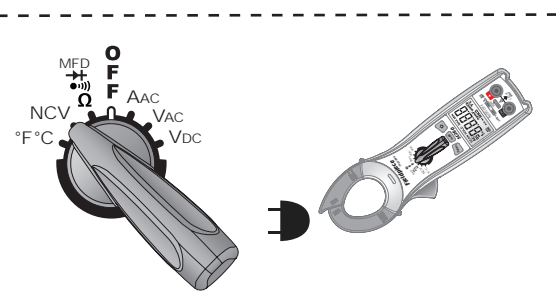
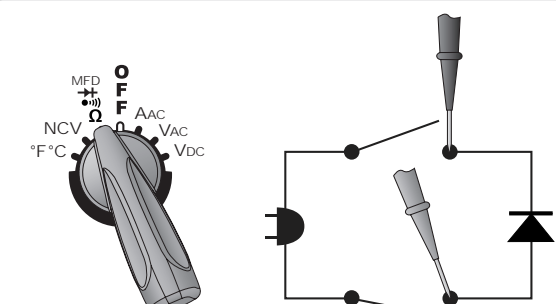

Non Contact Voltage (NCV)

Use NCV to check for 24VAC from a thermostat or live voltage up to 600VAC. Always test on a known live source before using. A three segment graph and RED LED will display the presence of voltage. The audible beep increases from intermittent to continuous as intensity of field (EF) increases.

AC Voltage Detection Range: 24VAC to 600VAC (50-60Hz)

Amps AC (AAC)

Test any isolated power line, compressor or capacitor wire. True RMS on SC260 only.

Ranges: 40A, 400A **Resolution:** 0.01A **Crest factor:** ≤ 3

Accuracy: $\pm(2.0\% + 10)$ 50-60Hz **Jaw Opening:** 1.2in (30 mm)

True RMS: model SC260 only **Overload Protection:** 400AAC

Note: AAC through the clamp and voltage through the test leads can be measured simultaneously. However, if only AAC is measured through the clamp, test leads and thermocouple must be unplugged from the meter.

11

12

13

14

15

MicroAmps DC (μ ADC) SC220 only

Microamps for flame rectifier test on a heater control. Connect leads between flame sensor probe and control module and turn heating unit on to read μ A measurement. When the flame is on, there should be a measurable μ ADC signal, typically under 10 μ ADC. Compare measurement to manufacturer's specification to determine if replacement is necessary.

Ranges: 400 μ A, 4000 μ A **Resolution:** 0.1 μ A

Accuracy: $\pm(1.0\% + 2)$ **Voltage burden:** 1V, 8V on 4000 μ A

Overload Protection: 600VDC or 600VAC rms

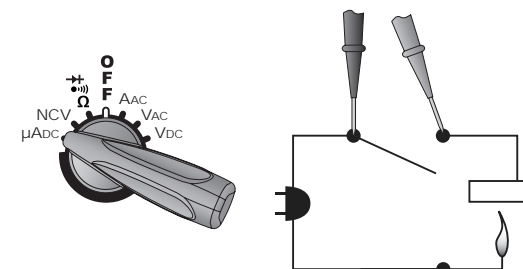

Auto Select Mode

For SC240/260 only. Save time and let your meter select the appropriate test parameter. Set the selector switch to Ω / \bullet / \rightarrow / MFD and use your test leads to take the measurement. The clamp meter will automatically display an ohms, diode, continuity, or capacitance reading. In Auto Select mode, the **M/m** and **Range** buttons are disabled.

Temp. Calibration

For accuracies of $\pm 1^\circ$ F, calibrate to a known temperature. A glass of stabilized ice water is very close to 32 $^\circ$ F (0 $^\circ$ C) and is usually very convenient but any known temperature can be used. For SC240/SC260 models only.

1. Select the $^\circ$ F / $^\circ$ C range.
 2. Plug thermocouple to be calibrated into the Type K jack.
 3. Unscrew A and B and remove the battery cover.
 4. Stabilize a large cup of ice water. Stir the ice with the water until temperature stays at a stable value.
 5. Immerse the thermocouple probe and let it stabilize. Keep stirring water to prevent micro-environments.
 6. Do not let the thermocouple come in direct contact with ice.
 7. Use a small screwdriver to adjust calibration pot C below the battery as close to 32 $^\circ$ F (0 $^\circ$ C) as you would like.
- Note: J1-J2 switch is for auto-calibration purposes only. Not intended for use in the field.

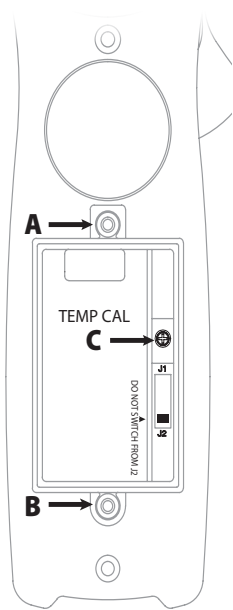

Safety Features

1. Bright LED and beeper warn when testing voltages >16VAC/35VDC. High Voltage warning.
2. Switch to the NCV function (non contact voltage) and point clamp claw towards suspected voltage source. Monitor the bright RED LED and beeper to see if the source is "hot."
3. Temperature switch prevents the thermocouple plugging in while measuring voltage.

Auto Hold

Press and hold **HOLD** for two seconds. Meter will beep and HOLD will blink on LCD. After 6 seconds the measurement on screen will freeze automatically. Press **HOLD** to exit this mode.

Auto Power Off

Auto power off or APO will automatically turn off your meter after 30 minutes of inactivity. By default it is activated and APO will show on the display. To disable, turn meter off. Hold **M/m** (SC240/260) and power on the meter by turning the selector dial to any range. For SC220, follow the same procedure but hold **Range** and power on.

Max/Min SC240 and SC260 only

Record and freeze the maximum and minimum measurements. Connect the test leads to begin the measurement, then press **M/m** once to freeze the maximum reading. MAX will show on display. Press **M/m** again to freeze the minimum reading. MIN will show on display. Press **M/m** again to display real-time measurement with both maximum and minimum readings recording in the background. MAX MIN will blink on display. Press and hold **M/m** for one second to exit Max/Min mode.

Max/Min functionality is disabled in Auto Select mode.--

Battery Replacement

When the battery is low, the battery icon will empty and blink for 30 seconds. "LO.bt" will display and meter will power off.

Turn dial to OFF position, disconnect test leads and remove the battery cover. Remove old battery and replace with a standard 9V battery only.

Maintenance

Clean the exterior with a dry cloth. Do not use liquid.

Limited Warranty

This meter is warranted against defects in material or workmanship for one year from date of purchase. Fieldpiece will replace or repair the defective unit, at its option, subject to verification of the defect.

This warranty does not apply to defects resulting from abuse, neglect, accident, unauthorized repair, alteration, or unreasonable use of the instrument.

Any implied warranties arising from the sale of a Fieldpiece product, including but not limited to implied warranties of merchantability and fitness for a particular purpose, are limited to the above. Fieldpiece shall not be liable for loss of use of the instrument or other incidental or consequential damages, expenses, or economic loss, or for any claim of such damage, expenses, or economic loss.

State laws vary. The above limitations or exclusions may not apply to you.

Obtaining Service

Call Fieldpiece Instruments for one-price-fix-all out-of-warranty service pricing. Send check or money order for the amount quoted. Send the meter freight prepaid to Fieldpiece Instruments. Send proof of date and location of purchase for in-warranty service. The meter will be repaired or replaced, at the option of Fieldpiece, and returned via least cost transportation.

For international customers, warranty for products purchased outside of the U.S. should be handled through local distributors.

Fieldpiece
Designed in USA
MADE IN TAIWAN

www.fieldpiece.com

© Fieldpiece Instruments, Inc 2016; v17

16

17

18

19

20