

ENGLISH

User's manual



Contents:

1.	SAFETY PRECAUTIONS AND PROCEDURES.....	2
1.1.	Preliminary Instruction	2
1.2.	During use	3
1.3.	After use.....	3
1.4.	Definition of measuring (overvoltage) category	3
2.	GENERAL DESCRIPTION	4
3.	PREPARATION FOR USE	5
3.1.	Initial Control.....	5
3.2.	Power Supply	5
3.3.	Calibration.....	5
3.4.	Storage	5
4.	INSTRUMENT DESCRIPTION	6
4.1.	Instrument description	6
4.1.1.	STATUS LED	6
4.2.	Instrument's commands	6
5.	OPERATING INSTRUCTIONS.....	8
5.1.	Phase to Phase impedance measurement and Phase To Phase-Three-Phase Prospective Short Circuit Current Calculation.....	8
5.2.	Phase to Neutral impedance measurement and Phase To Neutral Prospective Short Circuit Current Calculation	9
5.3.	Phase To Pe (Protection Conductor) impedance measurement and Phase to Pe Prospective Short Circuit Current Calculation ...	10
6.	MASTER INSTRUMENT SETTINGS.....	11
6.1.	Operating Instrument for "TYPE 1" Instrument	11
6.1.1.	Instrument Settings	11
6.1.2.	Prospective Short Circuit Current Calculation	12
6.1.3.	Run the Test.....	12
6.1.4.	Test results analysis.....	13
6.1.5.	Anomalous results for "P-P", "P-N", "P-PE" Test	14
6.2.	Operating Instrument for "TYPE 2" Instrument	17
6.2.1.	Instrument Settings	17
6.2.2.	Prospective Short Circuit Current Calculation	17
6.2.3.	Run the Test.....	18
6.2.4.	Test result analysis.....	18
6.2.5.	Anomalous results for "P-P", "P-N", "P-PE" Test	19
6.3.	Operating Instrument for "TYPE 3" Instrument	22
6.3.1.	Instrument Settings	22
6.3.2.	Prospective Short Circuit Current Calculation	23
6.3.3.	Run the Test.....	24
6.3.4.	Test result analysis.....	24
6.3.5.	Anomalous results for "P-P", "P-N", "P-PE" Test	25
6.4.	Operating Instrument for "TYPE 4" Instrument	28
6.4.1.	Instrument Settings	28
6.4.2.	Prospective Short Circuit Current Calculation	29
6.4.3.	Run the Test.....	29
6.4.4.	Test result analysis.....	29
6.4.5.	Anomalous results	29
6.5.	Operating Instrument for "TYPE 5" Instrument	32
6.5.1.	Instrument Settings	32
6.5.2.	Prospective Short Circuit Current Calculation	32
6.5.3.	Run the Test.....	32
6.5.4.	Test result analysis.....	32
6.5.5.	Anomalous results.....	33
7.	TEST RESULTS DOWNLOAD.....	34
8.	MAINTENANCE	34
8.1.	General	34
8.2.	Instrument cleaning.....	34
8.3.	End of life	34
9.	TECHNICAL SPECIFICATIONS	35
9.1.	Technical Features	35
9.1.1.	Safety Guidelines:	35
9.1.2.	Safety standards	35
9.1.3.	General Characteristics	35
9.2.	Environment.....	36
9.2.1.	Environmental condition	36
9.3.	Accessories.....	36
10.	SERVICE.....	37
10.1.	Warranty.....	37
10.2.	Service.....	37

1. SAFETY PRECAUTIONS AND PROCEDURES

This apparatus conforms with safety standards EN61557 and EN 61010 relating to electronic measuring instruments.

For your own safety as well as that of the apparatus you are recommended to follow the procedures described in this instruction manual and carefully read all the notes preceded by the symbol .



WARNING

Should you fail to keep to the prescribed instructions you could damage the instrument and/or its components or endanger your safety.

Strictly keep to the following instructions before and during measurements:

- Do not take measurements in wet environments.
- Do not effect measurements in environments with explosive gas, fuels or dust.
- Keep you insulated from the object under test waiting for measuring.
- Avoid any contact with exposed metal parts, ends of test leads not in use, circuits, etc.
- Do not effect any measurement in case of unusual conditions of the instrument such as deformation, breakage, leakage of substances, etc.
- Pay careful attention when measuring voltages exceeding 20V because of the risk of electric shock.

The following symbols are used in this manual:



Caution: refer to the instructions manual; improper use may damage the apparatus or its components.



Double-insulated meter.



AC Voltage or Current.

1.1. PRELIMINARY INSTRUCTION

- This instrument has been designed for use in environments with a degree of pollution 2.
- It can be used for tests for **Impedance measurements** on electrical installations with overvoltage category III up to 240V (Nominal Voltage to Earth) and up to 415V (Nominal voltage Phase to Phase).
- You are recommended to comply with the usual safety regulations aimed at:
 - ◆ Protecting you against dangerous currents.
 - ◆ Protecting the instrument against improper use.
- Only the leads supplied with the instrument guarantee compliance with the safety standards. They must be in good conditions and must be replaced, if necessary, with identical models.
- Do not effect any measurement in electrical system which doesn't comply with the Voltage limits here indicated
- Do not effect any measurement under environmental conditions beyond the limits specified in paragraph 9.2.

1.2. DURING USE

Carefully read the following recommendations and instructions:



WARNING

No compliance with the Warnings and/or Instructions may damage the apparatus and/or its components or injure the operator.

- When the instrument is connected to the tested circuit never touch any test lead which is not being used.
- The STATUS LED blinking in red indicates that the instrument is overheating. You will have to wait until STATUS LED get back to GREEN status before executing new test.
- Never execute more than 50 test in one hour.
- The red colour (fixed) of STATUS LED indicates a dangerous situation. Disconnect immediately Test Leads from the Circuit under Test.

1.3. AFTER USE

- Always disconnect alligator clips from the circuit under Test before disconnecting Test cables from Instrument's inputs.

1.4. DEFINITION OF MEASURING (OVERVOLTAGE) CATEGORY

The norm EN 61010: Safety requirements for electrical equipment for measurement, control and laboratory use, Part 1: General requirements, defines what a measuring category, usually called overvoltage category, is.

Circuits are divided into the following measurement categories:

- **Measurement category IV** is for measurements performed at the source of the low-voltage installation.
Examples are electricity meters and measurements on primary overcurrent protection devices and ripple control units.
- **Measurement category III** is for measurements performed in the building installation.
Examples are measurements on distribution boards, circuit breakers, wiring, including cables, bus-bars, junction boxes, switches, socket-outlets in the fixed installation, and equipment for industrial use and some other equipment, for example, stationary motors with permanent connection to fixed installation.
- **Measurement category II** is for measurements performed on circuits directly connected to the low voltage installation.
Examples are measurements on household appliances, portable tools and similar equipment.
- **Measurement category I** is for measurements performed on circuits not directly connected to MAINS.
Examples are measurements on circuits not derived from MAINS, and specially protected (internal) MAINS-derived circuits. In the latter case, transient stresses are variable; for that reason, the norm requires that the transient withstand capability of the equipment is made known to the user.

2. GENERAL DESCRIPTION

Dear Customer, we thank you for your patronage. The instrument you have just purchased will grant you accurate and reliable measurements provided that it is used according to the present manual's instructions.

The instrument was designed to grant the user the utmost safety conditions thanks to a new concept assuring double insulation and overvoltage category III 240V (to Earth).

The instrument can perform Phase to Phase, Phase to Neutral and Phase to Protection Conductor (PE) Impedance measurement and Prospective Short Circuit current calculation (according to EN 60909-0).

As the instrument execute a 4 wire measurement (Volt-ampermetric measurement mode), the results aren't affected by Test Leads and alligator clips and it's not necessary to execute any Test Cable calibration.

The instrument is provided of special cables with double-contact alligator clip: the back and red part of the alligator clip are electrically separated and make two different test points. So the red sides of the alligator clips represent the Current Circuit (C1 and C2) while the black sides (P1 and P2) represent the Voltage measurement circuit.

The instrument is directly supplied by the Test Leads and the electrical network under test. It's not provided of a keyboard because all commands and results are exchanged by means the RS232 serial interface with the MASTER instrument. For further details see paragraph.

3. PREPARATION FOR USE

3.1. INITIAL CONTROL

This instrument has been checked mechanically and electrically prior to shipment. Any care has been taken to ensure that the instrument reaches you under safe conditions.

You are recommended, however, to carry out a rapid check to detect any possible damage which might have been caused during transport. Should this be the case, immediately contact HT Italia.

Check also that the packaging contains all the parts listed under paragraph 9.3. In case of discrepancies contact the dealer.

In case you have to send the instrument back please follow the instructions reported in paragraph 10.

3.2. POWER SUPPLY

The instrument is directly supplied by the Test Leads and the electrical network under test. The voltage mains must be in 220 – 415V range and the mains frequency must be in 50Hz +/- 5% range.

3.3. CALIBRATION

The instrument fulfils the technical specifications listed in this manual. The performance of the specifications are guaranteed for one year.

3.4. STORAGE

In order to grant the accuracy of the measurements, after a period of storage in extreme environmental conditions, wait for the time necessary so that the apparatus is back to normal measuring conditions (see environmental specifications listed in paragraph 9.2).

4. INSTRUMENT DESCRIPTION

4.1. INSTRUMENT DESCRIPTION

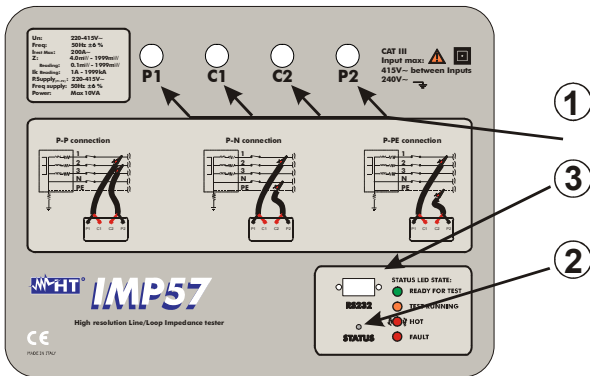

LEGEND:

- 1 Terminals C1, P1, C2, P2 for impedance tests.
- 2 STATUS LED
- 3 RS232 Serial interface.

Fig. 1: Instrument description

4.1.1. STATUS LED

The STATUS LED can assume the following colour

- OFF: Instrument not supplied.
- GREEN: Instrument ready for Test.
- ORANGE: Test running.
- RED (blinking): Instrument overheated. Please wait until LED status get back to GREEN colour before executing new test.
- RED (fixed): Disconnect immediately the instrument form the circuit under test. Check the nominal voltage range ($220 \div 415V$) and the frequency range ($47.5 \div 52.5Hz$). Also check anomalous situation in paragraph 6.1.5, 6.2.5, 6.3.5, 6.4.5 and 6.5.5.

4.2. INSTRUMENT'S COMMANDS

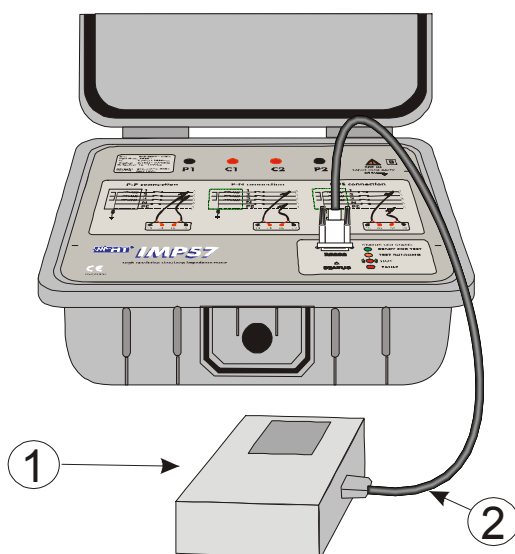

LEGEND:

- 1 MASTER Instrument.
- 2 RS232 cable: C2001 or C232NG1.

Fig. 2: Connecting IMP57 to MASTER instrument

The instrument is fully controlled by means the RS232 serial interface. The IMP57 can be connected to the following MASTER instruments:

MASTER Instrument	Instrument Type	Firmware	Upgrading Proc.
GSC57, GSC53, GENIUS5080E, GSC53N, SIRIUS 89	1	1.37 or successive	User (*)
MACROTEST 5035, SIRIUS 87	2	1.16 or successive	User (*)
COMBITEST 2019		1.33 or successive	HT
COMBITEST420, COMBITEST419, SPEEDTEST 418	3	1.02 or successive	----
FULLTEST4058	4	1.08 or successive	HT
FULLTEST4050	5	A3.0 or successive	HT

Table 1: Instruments Type

(*) If the Firmware release is older, please execute the Firmware upgrading procedure described in file "**Readme_Leggimi.pdf**" included in package.

HT recommends to check the Firmware release of the MASTER instrument before attempt to execute the test. This information is present in the "Switch-ON screen" of the MASTER instrument.

Test results are sent by IMP57 to MASTER instrument through C2001 or C232NG1 cable.

All the stored test results can be reviewed on the MASTER instrument display and sent to a personal computer.

5. OPERATING INSTRUCTIONS

5.1. PHASE TO PHASE IMPEDANCE MEASUREMENT AND PHASE TO PHASE-THREE-PHASE PROSPECTIVE SHORT CIRCUIT CURRENT CALCULATION



WARNING

- Never use the instrument in electrical plants with Nominal phase to phase voltage higher than 415V or a Nominal phase to neutral voltage or phase to ground voltage higher than 240V.
- The Phase to Phase impedance measurement entails the flowing of a current up to 200A between the above said conductors. This can cause tripping of magnetothermal switch having rated value lower than 200A. If necessary execute the measurement upstream the switch.
- If possible disconnect all the low impedance loads connected downstream the point where the test is to be carried out as the impedance of the above said loads results to be in parallel with the impedance under test.
- Always make sure that the upper and lower metal plate of the alligator clips make good contact with the conductors of the circuit under test.
- Never disconnect the Alligator clips or Test leads during the Test.

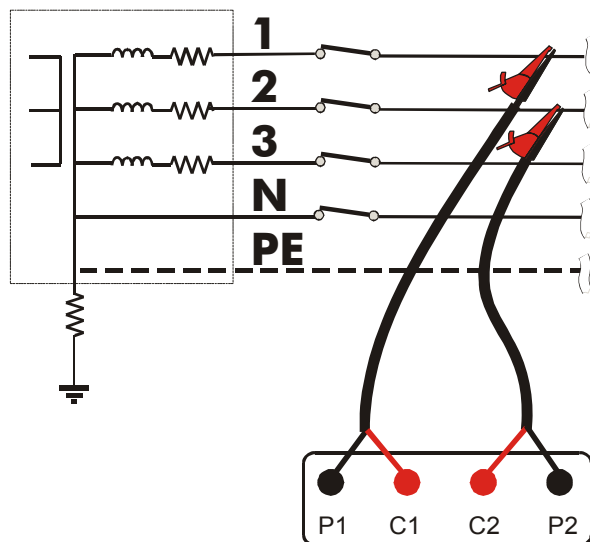

Fig. 3: Instrument connection for phase to phase impedance measurement

1. Connect the IMP57 RS232 to MASTER instrument through RS232 cable (see paragraph 4.2).
2. Connect the alligator clip to the Electrical plant according to Fig. 3.
3. Insert the 4 safety connectors into corresponding instrument's inputs **according to sequence P1, P2, C2, C1** (see Fig. 3).
4. Check if the STATUS LED is light in Green.
5. Switch ON the MASTER instrument, select the "Phase to Phase Measurement mode" and Start the Test (see chapter 6).

For further details and description about Test results and Save procedure see chapter 6.

5.2. PHASE TO NEUTRAL IMPEDANCE MEASUREMENT AND PHASE TO NEUTRAL PROSPECTIVE SHORT CIRCUIT CURRENT CALCULATION

WARNING



- Never use the instrument in electrical plants with Nominal phase to phase voltage higher than 415V or a Nominal phase to neutral voltage or phase to ground voltage higher than 240V.
- The Phase to neutral impedance measurement entails the flowing of a current up to 116A between the above said conductors. This can cause tripping of magnetothermal switch having rated value lower than 116A. If necessary execute the measurement upstream the switch.
- If possible disconnect all the low impedance loads connected downstream the point where the test is to be carried out as the impedance of the above said loads results to be in parallel with the impedance under test.
- Always make sure that the upper and lower metal plate of the alligator clips make good contact with the conductors of the circuit under test.
- Never disconnect the Alligator clips or Test leads during the Test.

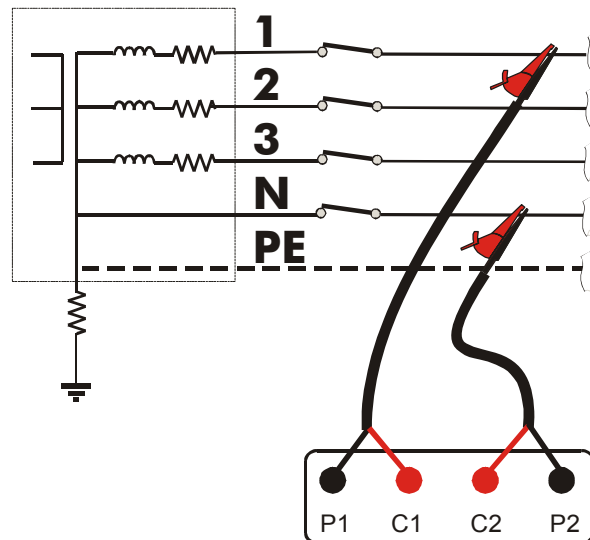

Fig. 4: Instrument connection for phase to neutral impedance measurement

1. Connect the IMP57 RS232 to MASTER instrument through RS232 cable (see paragraph 4.2).
2. Connect the alligator clip to the Electrical pant according to Fig. 4.
3. Insert the 4 safety connectors into corresponding instrument's inputs **according to sequence P1, P2, C2, C1** (see Fig. 4).
4. Check if the STATUS LED is light in Green.
5. Switch ON the MASTER instrument, select the "Phase to Neutral Measurement mode" and Start the Test (see chapter 6).

For further details, description about Test results and Save procedure see paragraph 6.

5.3. PHASE TO PE (PROTECTION CONDUCTOR) IMPEDANCE MEASUREMENT AND PHASE TO PE PROSPECTIVE SHORT CIRCUIT CURRENT CALCULATION



WARNING

- Never use the instrument in electrical plants with Nominal phase to phase voltage higher than 415V or a Nominal phase to neutral voltage or phase to ground voltage higher than 240V.
- The Phase to PE impedance measurement entails the flowing of a current up to 116A between the above said conductors. This can cause tripping of magnetothermal switch having rated value lower than 116A and will cause the RCD tripping. If necessary execute the measurement upstream the switch or RCD.
- If possible disconnect all the low impedance loads connected downstream the point where the test is to be carried out as the impedance of the above said loads results to be in parallel with the impedance under test.
- Always make sure that the upper and lower metal plate of the alligator clips make good contact with the conductors of the circuit under test.
- Never disconnect the Alligator clips or Test leads during the Test.

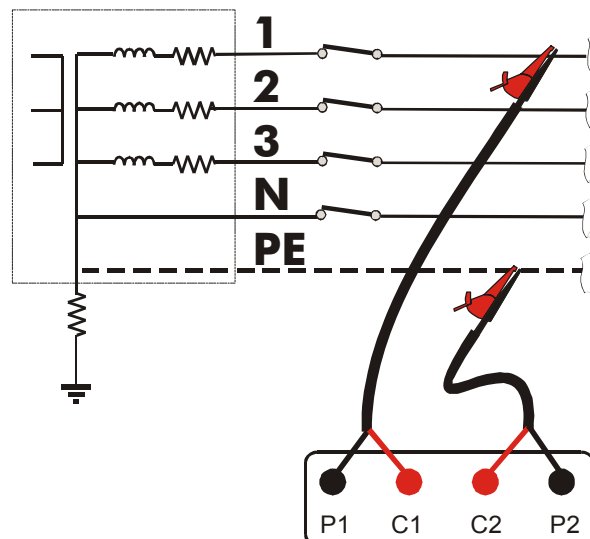

Fig. 5: Instrument connection for phase to ground impedance measurement

1. Connect the IMP57 RS232 to MASTER instrument through RS232 cable (see paragraph 4.2).
2. Connect the alligator clip to the Electrical pant according to Fig. 5.
3. Insert the 4 safety connectors into corresponding instrument's inputs **according to sequence P1, P2, C2, C1** (see Fig. 5).
4. Check if the STATUS LED is light in Green.
5. Switch ON the MASTER instrument, select the "Phase to PE Measurement mode" and Start the Test (see chapter 6).

For further details, description about Test results and Save procedure see chapter 6.

6. MASTER INSTRUMENT SETTINGS

Operating Instruction are given according to **Table 1 - Instrument Type** definition.

6.1. OPERATING INSTRUMENT FOR "TYPE 1" INSTRUMENT

6.1.1. Instrument Settings

Select **LOOP** rotary switch position.

F1

Select one of the following connection by means **F1** button.

"P-P", "P-N", "P-PE"

available among the functions "P-P", "P-N", "P-PE", " $R_A \perp$ ", "⊙".

F2

Press **F2** to Enable the "High Resolution Measurement **Z2Ω**" working mode. correspondently the **Z2Ω** symbol will be displayed in the lower part of the display.

F1

When **Z2Ω** working mode is enabled it's possible to select one of the following measurement mode by means the **F1** button.

- ☞ **"P-N"** The instrument execute the High Resolution Phase-Neutral impedance measurement and calculate the Prospective Short circuit Current Calculation selected.
- ☞ **"P-P"** The instrument execute the High Resolution Phase-Phase impedance measurement and calculate the Prospective Short circuit Current Calculation selected.
- ☞ **"P-PE"** The instrument execute the High Resolution Phase-ground impedance measurement and calculate the Prospective Short circuit Current Calculation selected.

F3

The **F3** button allows the selection of Prospective Short Circuit current calculation according to paragraph 6.1.2.

F4

By pressing the **F4** button the instrument will show the IMP57 Serial Number, the Firmware release and the calibration date. Press ESC to quit this screen.

Press **F2** button to quit High Resolution Measurement mode **Z2Ω**.

6.1.2. Prospective Short Circuit Current Calculation

Connection		
Phase - Phase (P-P)	$I_{MIN\ 3\ ph} = C_{MIN} \cdot \frac{U_{P-P}^{NOM}}{\frac{\sqrt{3}}{2} \cdot Z_{P-P}^{HOT}}$	$I_{MAX\ 3\ ph} = C_{MAX} \cdot \frac{U_{P-P}^{NOM}}{\frac{\sqrt{3}}{2} \cdot Z_{P-P}}$
	Three Phase Minimum Prospective Short Circuit Current	Three Phase Maximum Prospective Short Circuit Current
Phase - Neutral (P-N)	$I_{MIN\ 2\ ph} = C_{MIN} \cdot \frac{U_{P-P}^{NOM}}{Z_{P-P}^{HOT}}$	$I_{MAX\ 2\ ph} = C_{MAX} \cdot \frac{U_{P-P}^{NOM}}{Z_{P-P}}$
	Two Phase Minimum Prospective Short Circuit Current	Two Phase Maximum Prospective Short Circuit Current
Phase - Protection conductor (P-PE)	$I_{MIN\ P-N} = C_{MIN} \cdot \frac{U_{P-N}^{NOM}}{Z_{P-N}^{HOT}}$	$I_{MAX\ P-N} = C_{MAX} \cdot \frac{U_{P-N}^{NOM}}{Z_{P-N}}$
	Single Phase Minimum Prospective Short Circuit Current	Single Phase Maximum Prospective Short Circuit Current
Generic	$I_{MIN\ P-PE} = C_{MIN} \cdot \frac{U_{P-PE}^{NOM}}{Z_{P-PE}^{HOT}}$	$I_{MAX\ P-PE} = C_{MAX} \cdot \frac{U_{P-PE}^{NOM}}{Z_{P-PE}}$
	Fault to Ground Minimum Prospective Short Circuit Current	Fault to Ground Maximum Prospective Short Circuit Current
	$I_{STD} = \frac{U^{NOM}}{Z_{MIS}}$ Generic Prospective Short Circuit Current	

where:

$$Z_{P-X}^{HOT} = \sqrt{(1.5 \cdot R_{P-X})^2 + X_{P-X}^2}$$

and

Voltage	U _{NOM}	C _{MIN}	C _{MAX}
230V-10% < V _{measured} < 230V+ 10%	230V	0,95	1,05
230V+10% < V _{measured} < 400V- 10%	V _{measured}	1,00	1,10
400V-10% < V _{measured} < 400V+ 10%	400V	0,95	1,05

6.1.3. Run the Test

When the IMP57 has been connected according to paragraph 5 and the MASTER instrument has been set according to paragraph 6.1.1 and 6.1.2, you can run the Test by means the **START** button.

During the test the STATUS LED will get Orange colour and when the Test is completed the results will be shown on instrument display.

6.1.4. Test results analysis

- "P-P" Test result

After the Test the instrument will show a screen as indicated below:

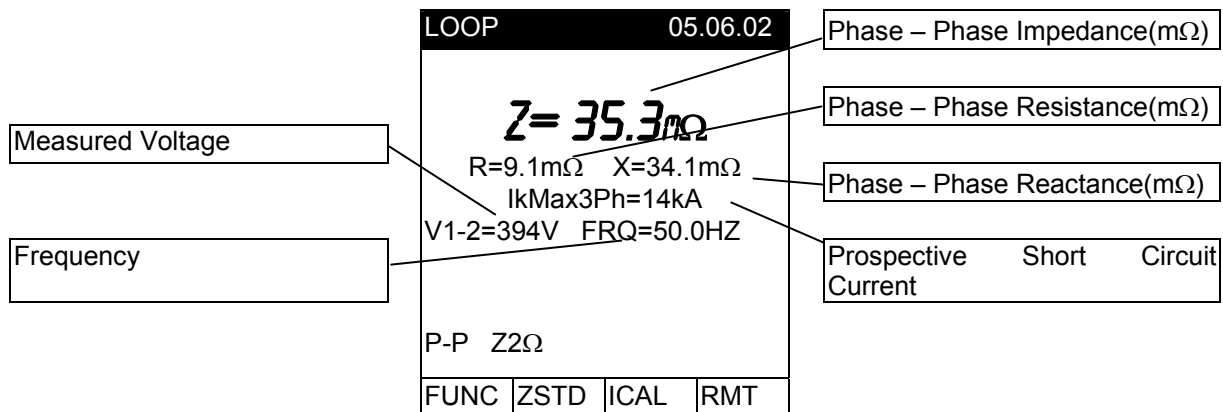

The Prospective Short Circuit Current is calculated according to one of the relationship indicates in paragraph 6.1.2 for Phase-Phase connection.



You can save these results by pressing the **SAVE** button **twice**.

- "P-N" Test result

After the Test the instrument will show a screen as indicated below:

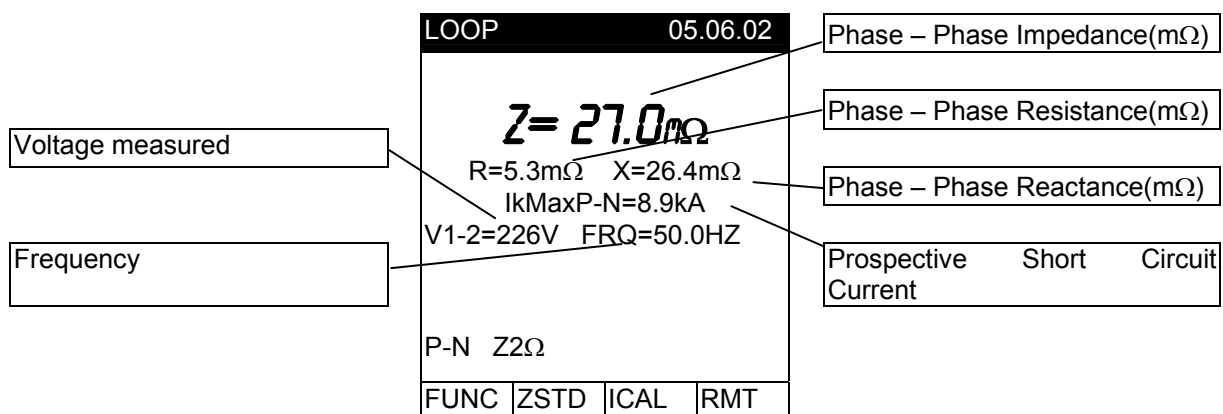

The Prospective Short Circuit Current is calculated according to one of the relationship indicates in paragraph 6.1.2 for Phase-Neutral connection.



You can save these results by pressing the **SAVE** button **twice**.

● "P-PE" Test result

After the Test the instrument will show a screen as indicated below:

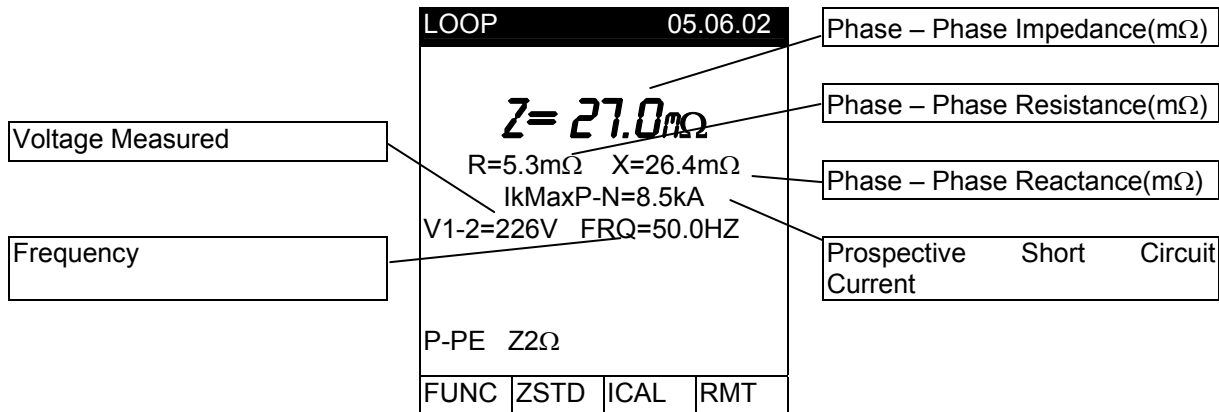

The Prospective Short Circuit Current is calculated according to one of the relationship indicates in paragraph 6.1.2 for Phase-Neutral connection.



You can save these results by pressing the **SAVE** button **twice**.

6.1.5. Anomalous results for "P-P", "P-N", "P-PE" Test

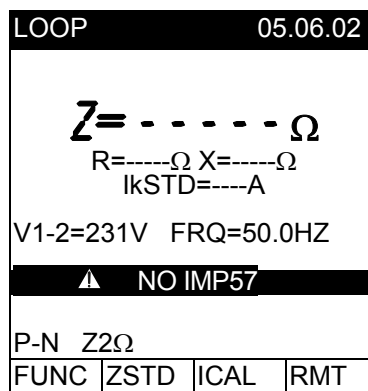

The message "**▲ NO IMP57**" indicate that IMP57 doesn't reply to RS232 commands of the MASTER instrument. Please check if:

1. The MASTER instrument is connected to IMP57 through C2001 optical cable.
2. The STATUS LED is green.

☞ After pressing START button, the message on side indicates that the MASTER instrument is supplied by using the External power supply adapter. Disconnect the External power supply adapter.

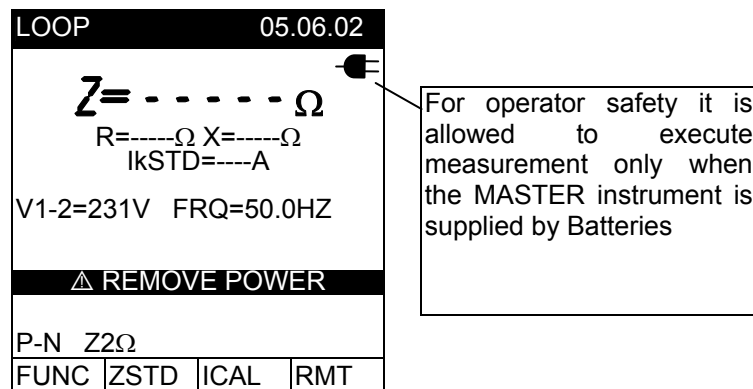

☞ After pressing START button, the message on side indicate that the mains voltage is too low (<190V).

LOOP		05.06.02	
$Z = \text{-----} \Omega$ R=----- Ω X=----- Ω IkSTD=----A V1-2=181V FRQ=50.0HZ			
△ LOW VOLTAGE			
P-N Z2 Ω			
FUNC	ZSTD	ICAL	RMT

Low Voltage Indication

☞ After pressing START button, the message on side indicate that the mains voltage is >460V (415V + 10%).

LOOP		05.06.02	
$Z = \text{-----} \Omega$ R=----- Ω X=----- Ω IkSTD=----A V1-2=461V FRQ=50.0HZ			
△ HIGH VOLTAGE			
P-P Z2 Ω			
FUNC	ZSTD	ICAL	RMT

High Voltage Indication

☞ After pressing START button, the message on side indicate that test current is too low (>10A). Please check that alligator clip are in contact with mains conductors.

LOOP		05.06.02	
$Z = \text{-----} \Omega$ R=----- Ω X=----- Ω IkSTD=----A V1-2=461V FRQ=50.0HZ			
CURRENT NOT OK			
P-P Z2 Ω			
FUNC	ZSTD	ICAL	RMT

- ☞ If the instrument is overheated the display will show the message on side. Please wait until the LED STATUS on IMP57 get back to Green light.

LOOP		05.06.02	
$Z = \text{-----} \Omega$ R=----- Ω X=----- Ω IkSTD=----A V1-2=461V FRQ=50.0HZ			
HIGH TEMP			
P-P Z2 Ω			
FUNC	ZSTD	ICAL	RMT

Instrument overheated

- ☞ If You get the message on side after pressing START button, please contact HT Service.

LOOP		05.06.02	
$Z = \text{-----} \Omega$ R=----- Ω X=----- Ω IkSTD=----A V1-2=461V FRQ=50.0HZ			
Error 5			
P-P Z2 Ω			
FUNC	ZSTD	ICAL	RMT

PREVIOUS RESULT CAN'T BE STORED INTO INSTRUMENT MEMORY.

- ☞ If the instrument measure an impedance higher than 1999m Ω will show the message on side. Disable the **Z2 Ω** High Resolution measurement mode and execute standard LOOP measurement.

LOOP		05.06.02	
$Z > 1999m\Omega$ R>1999m Ω X>1999m Ω IkSTD=----A V1-2=461V FRQ=50.0HZ			
P-P Z2 Ω			
FUNC	ZSTD	ICAL	RMT

The ">" symbol indicate that the measure is higher than 1999m Ω



You can save these results by pressing the **SAVE** button **twice**.

6.2. OPERATING INSTRUMENT FOR “TYPE 2” INSTRUMENT

Operating Instruction are given according to **Table 1 - Instrument Type** definition.

6.2.1. Instrument Settings

Select **LOOP** rotary switch position.

FUNC

Select one of the following connection by means **FUNC** button.

"P-P", "P-N", "P-PE"

available among the functions "P-P", "P-N", "P-PE", " $R_A \perp$ ", " \odot ".

Un/Δn

Press **Un/Δn** to enable the "High Resolution Measurement **Z2Ω**" working mode. correspondently the **LOWΩ** and **LOOP** symbols will be displayed in the lower part of the display.

FUNC

When **Z2Ω** working mode is enabled it's possible to select one of the following measurement mode by means the **FUNC** button.

- ☞ **"P-N"** The instrument execute the High Resolution Phase-Neutral impedance measurement and calculate the Prospective Short circuit Current.
- ☞ **"P-P"** (The instrument execute the High Resolution Phase-Phase impedance measurement and calculate the Prospective Short circuit Current.
- ☞ **"P-PE"** The instrument execute the High Resolution Phase-ground impedance measurement and calculate the Prospective Short circuit Current.

Press **Un/Δn** button to quit High Resolution Measurement mode **Z2Ω**.

6.2.2. Prospective Short Circuit Current Calculation

Independently by the connection selected, the instrument calculated the Prospective short circuit current as:

$$I_{STD} = \frac{U^{NOM}}{Z_{MIS}}$$

Standard Prospective Short Circuit current

where

Voltage	U_{NOM}
$230V-10\% < V_{measured} < 230V+ 10\%$	230V
$230V+10\% < V_{measured} < 400V- 10\%$	$V_{measured}$
$400V-10\% < V_{measured} < 400V+ 10\%$	400V

6.2.3. Run the Test

When the IMP57 has been connected according to paragraph 5 and the MASTER instrument has been set according to paragraph 6.2.1 and 6.2.2, you can run the Test by means the **START** button.

During the test the STATUS LED will get Orange colour and when the Test is completed the results will be shown on instrument display.

6.2.4. Test result analysis

"P-P" Test Results

After the Test the instrument will show a screen as indicated below:

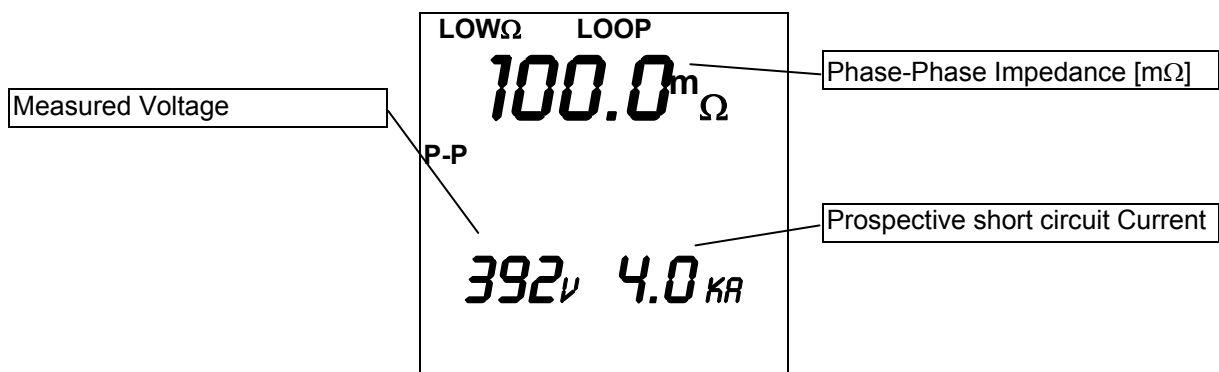

You can save these results by pressing the **SAVE** button **twice**.

"P-N" Test Results

After the Test the instrument will show a screen as indicated below:

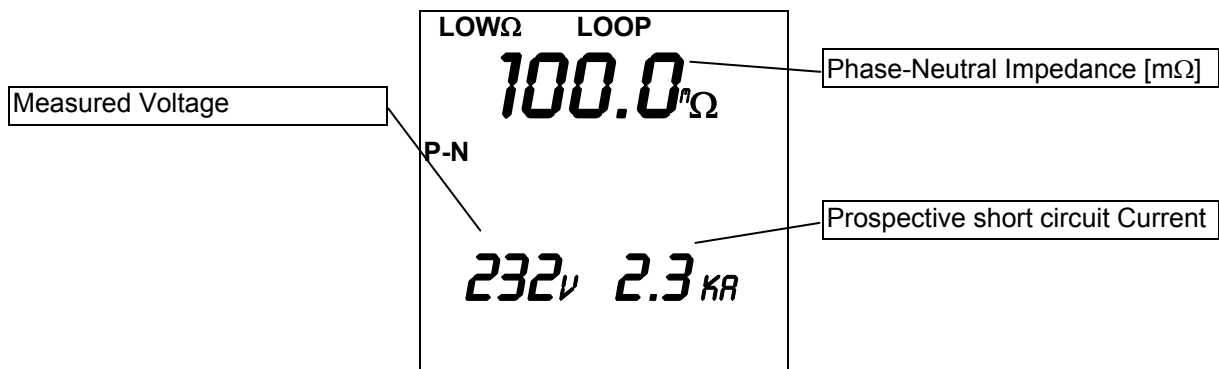

You can save these results by pressing the **SAVE** button **twice**.

"P-PE" Test Results

After the Test the instrument will show a screen as indicated below:

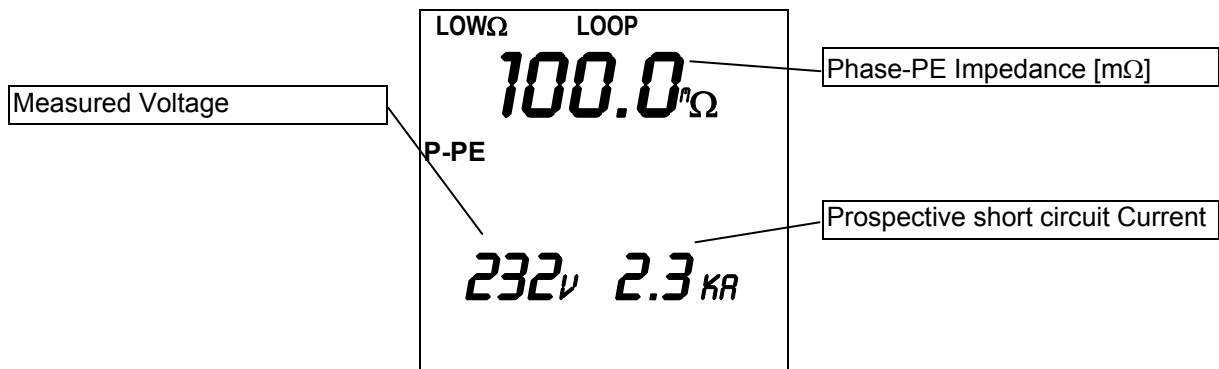

You can save these results by pressing the **SAVE** button **twice**.

6.2.5. Anomalous results for "P-P", "P-N", "P-PE" Test

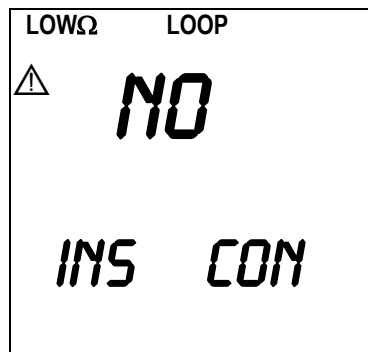

The message " \triangle no con inS" indicate that IMP57 doesn't reply to RS232 commands of the MASTER instrument. Please check if:

1. The MASTER instrument is connected to IMP57 through C2001 optical cable.
2. The STATUS LED is green.

☞ After pressing START button, the message on side indicate that the mains voltage is too low (<190V).

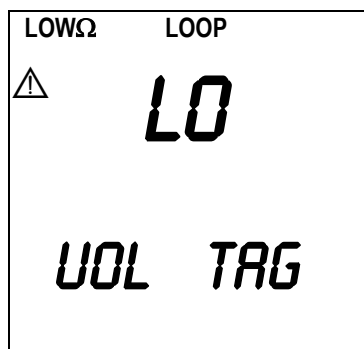

☞ After pressing START button, the message on side indicate that the mains voltage is too high (>460V).

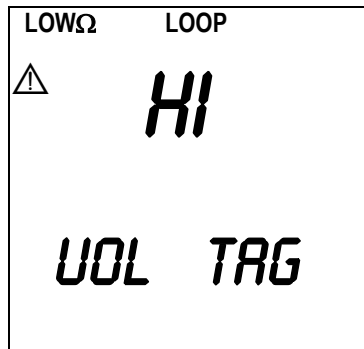

☞ After pressing START button, the message on side indicate that test current is too low (>10A). Please check that alligator clip are in contact with mains conductors.

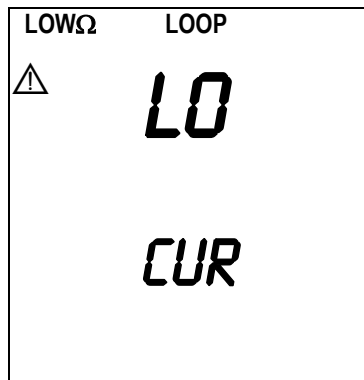

☞ If the instrument is overheated the display will show the message on side. Please wait until the LED STATUS on IMP57 get back to Green light.

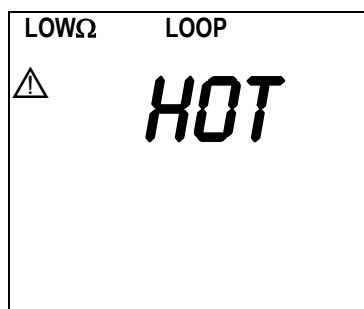

☞ If You get the message on side after pressing START button, please contact HT Service.

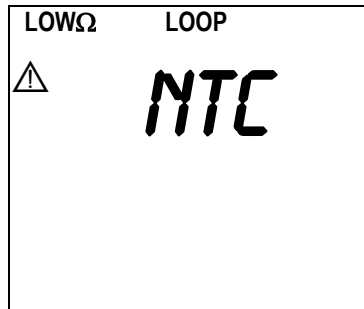

PREVIOUS RESULT CAN'T BE STORED INTO INSTRUMENT MEMORY.

☞ If the instrument measure an impedance higher than 1999mΩ will show the message on side. Disable the **Z2Ω** High Resolution measurement mode and execute standard LOOP measurement.

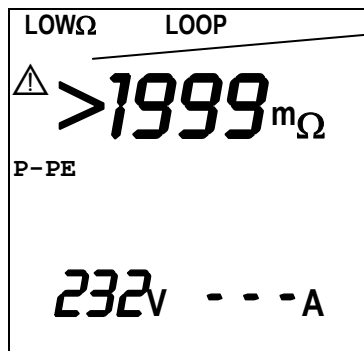

The ">" symbol indicate that the measure is higher than 1999mΩ



You can save these results by pressing the **SAVE** button **twice**.

6.3. OPERATING INSTRUMENT FOR “TYPE 3” INSTRUMENT

Operating Instruction are given according to **Table 1 - Instrument Type** definition.

6.3.1. Instrument Settings



Press **MENU** button, select **LOOP** by means ▲,▼ buttons and press **ENTER** button.

Mod.

Select by means ◀, ▶ buttons the virtual button **Mod.** and by means ▲,▼ buttons the **Z2Ω** function. The instrument shows:

LOOP		[Battery Icon]	
Z = ----- Ω			
R = ----- Ω		X = ----- Ω	
I k S T D = ----- A			
V1-2=230V		FRQ=50Hz	
P-N	Z2Ω		
Funz	Mod.	ICAL	RMT

Funz

Select by means ◀, ▶ buttons the virtual button **Funz** and by means ▲,▼ buttons the function:

- “**P-N**”: the instrument execute the High Resolution Phase-Neutral impedance measurement and calculate the Prospective Short circuit Current Calculation selected.
- “**P-P**”: the instrument execute the High Resolution Phase-Phase impedance measurement and calculate the Prospective Short circuit Current Calculation selected.
- “**P-PE**”: the instrument execute the High Resolution Phase-ground impedance measurement and calculate the Prospective Short circuit Current.

ICAL

Select by means ◀, ▶ buttons the virtual button **ICAL** which allows the selection of Prospective Short Circuit current calculation according to paragraph 6.3.2 by means ▲,▼ buttons.

RMT:

Select by means ◀, ▶ buttons the virtual button **RMT**. The instrument will show:

- IMP57 Serial Number.
- Firmware release.
- calibration date.

6.3.2. Prospective Short Circuit Current Calculation

The instrument calculated the Prospective short circuit current as:

Connection		
Phase - Phase (P-P)	$I_{MIN\ 3\ ph} = C_{MIN} \cdot \frac{U_{P-P}^{NOM}}{\frac{\sqrt{3}}{2} Z_{P-P}^{HOT}}$ Three Phase Minimum Prospective Short Circuit Current	$I_{MAX\ 3\ ph} = C_{MAX} \cdot \frac{U_{P-P}^{NOM}}{\frac{\sqrt{3}}{2} Z_{P-P}}$ Three Phase Maximum Prospective Short Circuit Current
Phase - Neutral (P-N)	$I_{MIN\ 2\ ph} = C_{MIN} \cdot \frac{U_{P-P}^{NOM}}{Z_{P-P}^{HOT}}$ Two Phase Minimum Prospective Short Circuit Current	$I_{MAX\ 2\ ph} = C_{MAX} \cdot \frac{U_{P-P}^{NOM}}{Z_{P-P}}$ Two Phase Maximum Prospective Short Circuit Current
Phase-Neutral (P-N)	$I_{MIN\ P-N} = C_{MIN} \cdot \frac{U_{P-N}^{NOM}}{Z_{P-N}^{HOT}}$ Single Phase Minimum Prospective Short Circuit Current	$I_{MAX\ P-N} = C_{MAX} \cdot \frac{U_{P-N}^{NOM}}{Z_{P-N}}$ Single Phase Maximum Prospective Short Circuit Current
Phase-Protection conductor (P-PE)	$I_{MIN\ P-PE} = C_{MIN} \cdot \frac{U_{P-PE}^{NOM}}{Z_{P-PE}^{HOT}}$ Fault to Ground Minimum Prospective Short Circuit Current	$I_{MAX\ P-PE} = C_{MAX} \cdot \frac{U_{P-PE}^{NOM}}{Z_{P-PE}}$ Fault to Ground Maximum Prospective Short Circuit Current
Generic	$I_{STD} = \frac{U^{NOM}}{Z_{MIS}}$ Generic Prospective Short Circuit Current	

where:

$$Z_{P-X}^{HOT} = \sqrt{(1.5 \cdot R_{P-X})^2 + X_{P-X}^2} \quad X = P, N, PE$$

and

Voltage	U_{NOM}	C_{MIN}	C_{MAX}
230V-10% < V _{measured} < 230V+ 10%	230V	0,95	1,05
230V+10% < V _{measured} < 400V- 10%	V _{measured}	1,00	1,10
400V-10% < V _{measured} < 400V+ 10%	400V	0,95	1,05

6.3.3. Run the Test

When the IMP57 has been connected according to paragraph 5 and the MASTER instrument has been set according to paragraph 6.3.1 and 6.3.2, you can run the Test by means the **START** button.

During the test the STATUS LED will get Orange colour and when the Test is completed the results will be shown on instrument display.

6.3.4. Test result analysis

"P-P" Test Results

The instrument, at the end of the test, does a **double sound signal**, that mean by the test is OK and it shows a screen like this on side.

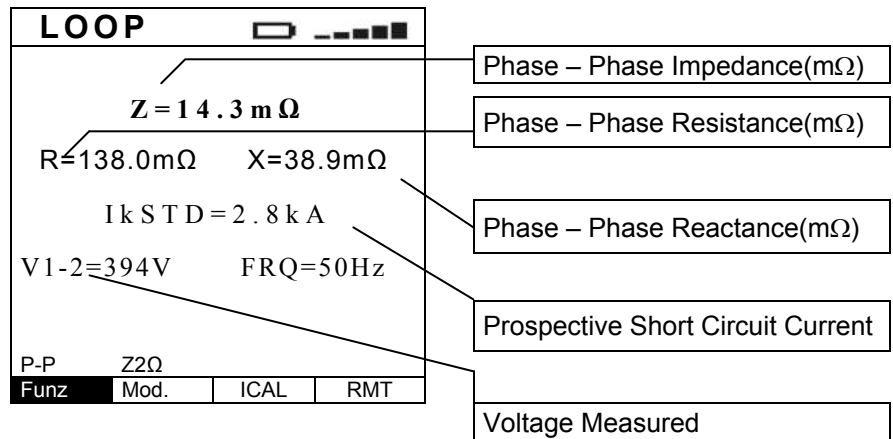

The Prospective Short Circuit Current is calculated according to one of the relationship indicates in paragraph 6.3.2 for Phase-Phase connection.

"P-N" Test Results

The instrument, at the end of the test, does a **double sound signal**, that mean by the test is OK and it shows a screen like this on side.

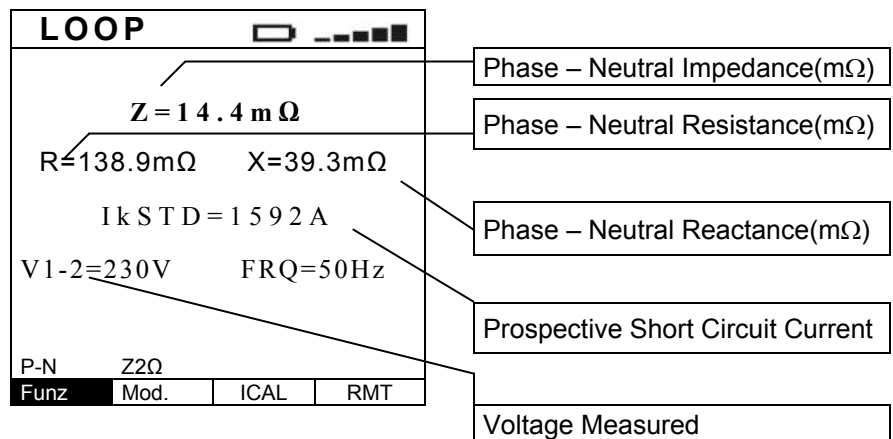

The Prospective Short Circuit Current is calculated according to one of the relationship indicates in paragraph 6.3.2 for Phase-Neutral connection.

"P-PE" Test Results

The instrument, at the end of the test, does a **double sound signal**, that mean by the test is OK and it shows a screen like this on side.

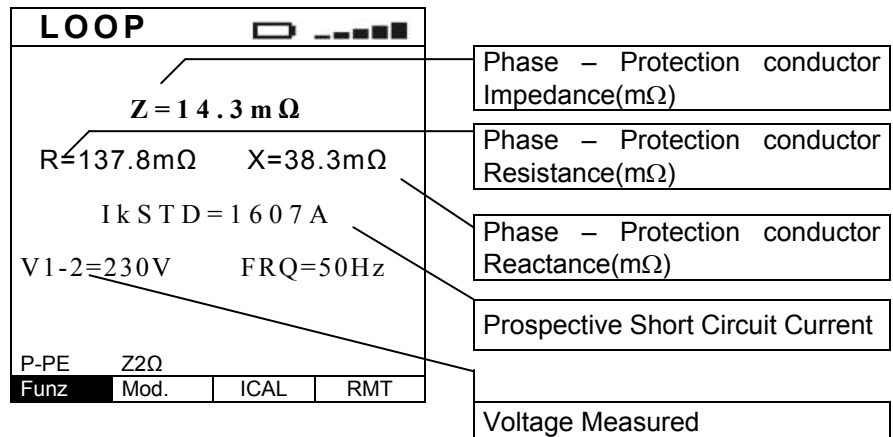

The Prospective Short Circuit Current is calculated according to one of the relationship indicates in paragraph 6.3.2 for Phase-Protection conductor connection.

You can save these results by pressing the **SAVE** button **twice** or by pressing the **SAVE** button and then the **ENTER** button.



6.3.5. Anomalous results for "P-P", "P-N", "P-PE" Test

The message "**NO IMP57**" indicate that IMP57 doesn't reply to RS232 commands of the MASTER instrument. Please check if the MASTER instrument is connected to IMP57 through C2001 optical cable and the STATUS LED is green.

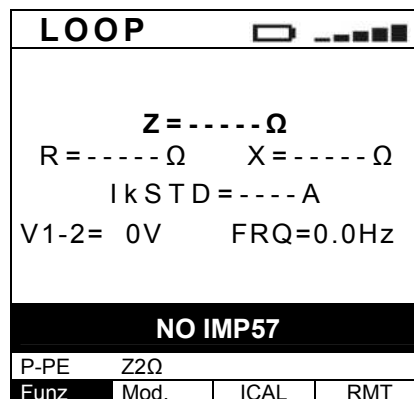

After pressing **GO/STOP** button, the message on side indicate that the mains voltage is too low (<190V).

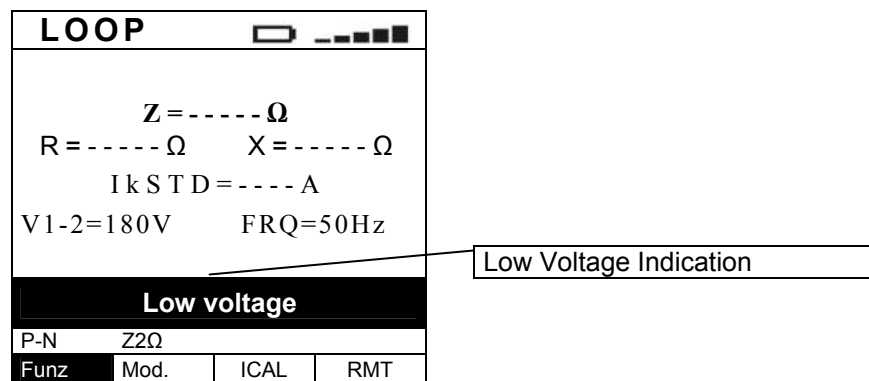

- ☞ After pressing **GO/STOP** button, the message on side indicate that the mains voltage is >460V (415V + 10%).

LOOP ▢ ▢ ▢ ▢ ▢			
Z = ----- Ω			
R = ----- Ω		X = ----- Ω	
I k S T D = ----- A			
V1-2=481V		FRQ=50Hz	
High voltage			
P-P		Z2Ω	
Funz	Mod.	ICAL	RMT

High Voltage Indication

- ☞ After pressing **GO/STOP** button, the message on side indicate that test current is too low (<10A). Please check that alligator clip are in contact with mains conductors.

LOOP ▢ ▢ ▢ ▢ ▢			
Z = ----- Ω			
R = ----- Ω		X = ----- Ω	
I k S T D = ----- A			
V1-2=460V		FRQ=50Hz	
Current NOT OK			
P-P		Z2Ω	
Funz	Mod.	ICAL	RMT

- ☞ After pressing **GO/STOP** button, the message on side indicate that the electric net frequency is not OK.

LOOP ▢ ▢ ▢ ▢ ▢			
Z = ----- Ω			
R = ----- Ω		X = ----- Ω	
I k S T D = ----- A			
V1-2=460V		FRQ=54Hz	
Sync error			
P-P		Z2Ω	
Funz	Mod.	ICAL	RMT

- ☞ If you get the message on side after pressing **GO/STOP** button, please contact HT Service.

LOOP ▢ ▢ ▢ ▢ ▢			
Z = ----- Ω			
R = ----- Ω		X = ----- Ω	
I k S T D = ----- A			
V1-2=460V		FRQ=50Hz	
Error NTC			
P-P		Z2Ω	
Funz	Mod.	ICAL	RMT

- ☞ If the instrument is overheated the display will show the message on side. Please wait until the LED STATUS on IMP57 get back to Green light.

LOOP ▢ ▢ ▢ ▢ ▢			
Z = ---- Ω			
R = ---- Ω		X = ---- Ω	
I k S T D = ---- A			
V1-2=280V		FRQ=50Hz	
High temp			
P-N		Z2Ω	
Funz	Mod.	ICAL	RMT

Instrument overheated

- ☞ Previous results **can't be** stored into instrument memory.

- ☞ If the instrument measure an impedance higher than **1999mΩ** will show the message on side. Disable the **Z2Ω** High Resolution measurement mode and execute standard LOOP measurement.

LOOP ▢ ▢ ▢ ▢ ▢			
Z > 1 9 9 9 m Ω			
R > 1999mΩ		X > 1999mΩ	
I k S T D = ---- A			
V1-2=230V		FRQ=50Hz	
P-N		Z2Ω	
Funz	Mod.	ICAL	RMT



The ">" symbol indicate that the measure is higher than 1999mΩ

- ☞  You can save these results by pressing the **SAVE** button **twice** or by pressing the **SAVE** button and then the **ENTER** button.

6.4. OPERATING INSTRUMENT FOR “TYPE 4” INSTRUMENT

Operating Instruction are given according to **Table 1 - Instrument Type** definition.

6.4.1. Instrument Settings

1.  Press power switch.
 2.  Press the **FUNC** key to select **CONTINUITY**.
 3.  Press the **MODE** key to select **EXT** mode. The instrument shows a screen as nearby.



CONTINUITY

EXT
m Ω

- - - - -



- - - - - A

238_v

READY
 4.  Press the **SET DISPLAY** key to select the mode of setting the magnetothermal protection nominal current **In**. Through the arrow keys   select the nominal current.



CONTINUITY

EXT

20 A
 5.  Press the **SET DISPLAY** key once again to select the mode of setting the protection type. Through the arrow keys   select the protection type (type B or C).

CONTINUITY

EXT

TYPE b
 6.  Press the **SAVE** key to confirm the modifications.
- OR
6.  Press the **ESC RECALL** key to quit without saving.

6.4.2. Prospective Short Circuit Current Calculation

The instrument calculated the Prospective short circuit current as:

$$I_{MIN P-PE} = C_{MIN} \cdot \frac{U_{P-PE}^{NOM}}{Z_{P-PE}^{HOT}}$$

Fault to Ground Minimum Prospective Short Circuit Current

Where:

$$Z_{P-PE}^{HOT} = \sqrt{(1.5 \cdot R_{P-PE})^2 + X_{P-PE}^2}$$

and

Voltage	U _{NOM}	C _{MIN}
230V-10% < V _{measured} < 230V+ 10%	230V	0,95
230V+10% < V _{measured} < 400V- 10%	V _{measured}	1,00
400V-10% < V _{measured} < 400V+ 10%	400V	0,95

6.4.3. Run the Test

When the IMP57 has been connected according to paragraph 5 and the MASTER instrument has been set according to paragraph 6.4.1 and 6.4.2, you can run the Test by

means the  **START/STOP** button.

During the test the STATUS LED will get Orange colour and when the Test is completed the results will be shown on instrument display.

6.4.4. Test result analysis

After the Test the instrument will show a screen as indicated below:

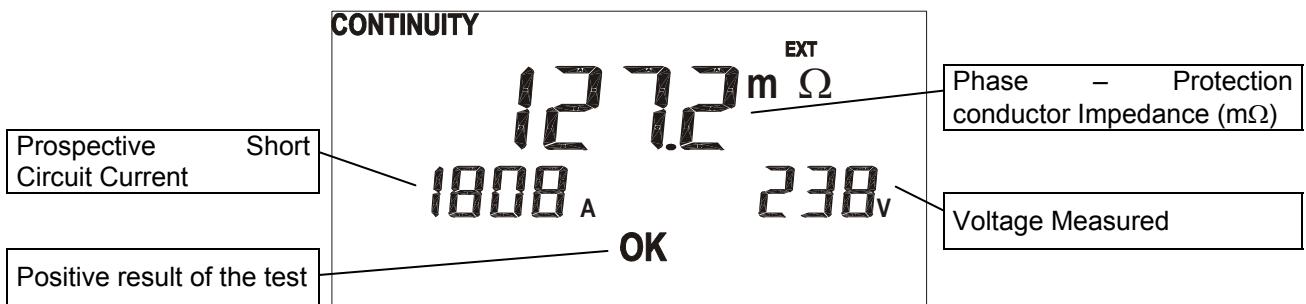

You can save these results by pressing the **SAVE** button **twice**.

6.4.5. Anomalous results

- The message "**NOT READY**" indicate that IMP57 doesn't reply to RS232 commands of the MASTER instrument. Please check if the MASTER instrument is connected to IMP57 through C232NG1 cable and the STATUS LED is green.

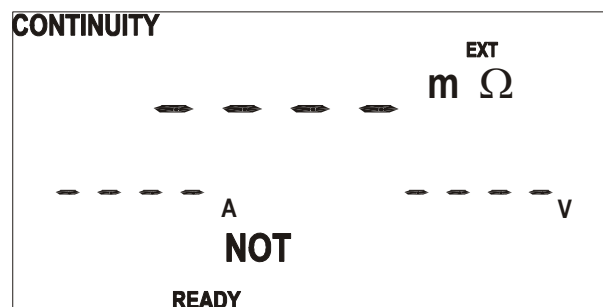

☞ After pressing



START/STOP button,
the message on side indicate that the
mains voltage is too low (<190V).

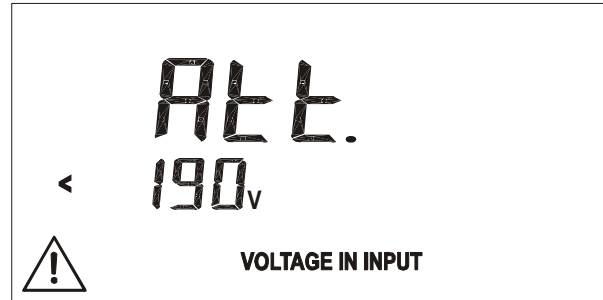

☞ After pressing



START/STOP button,
the message on side indicate that the
mains voltage is >460V (415V + 10%).

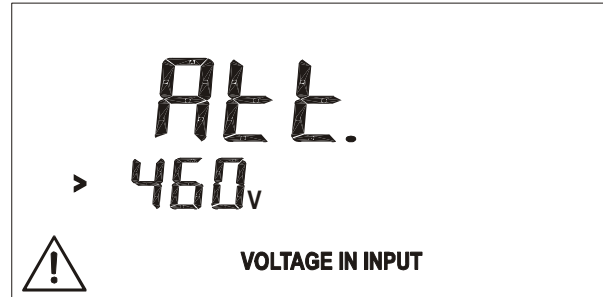

☞ After pressing



START/STOP button,
the message on side indicate that test
current is too low (<10A). Please check
that alligator clip are in contact with
mains conductors.

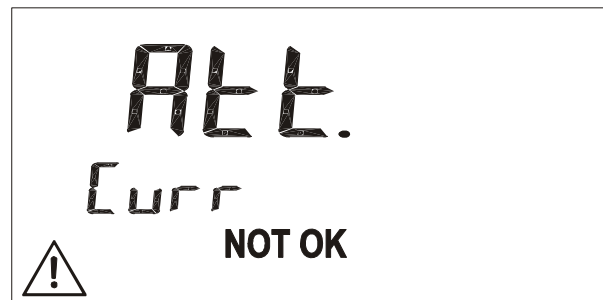

☞ After pressing



START/STOP button,
the message on side indicate that the
instrument is overheated.
Please wait until the LED STATUS on
IMP57 get back to Green light.



☞ After pressing



START/STOP button,
if the instrument indicate the message
on side, please contact HT Service.





☞ Previous results **can't be** stored into instrument memory.

- ☞ After a negative result of the Test, the instrument will show a screen as indicated on side.

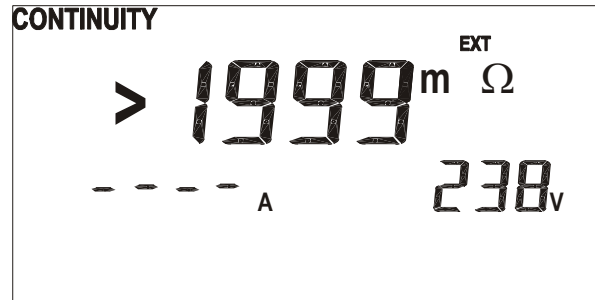

- ☞ If the instrument measure an impedance higher than 1999mΩ will show the message on side.



- ☞  You can save these results by pressing the **SAVE** button **twice**.

6.5. OPERATING INSTRUMENT FOR “TYPE 5” INSTRUMENT

Operating Instruction are given according to **Table 1 - Instrument Type** definition.

6.5.1. Instrument Settings

1. Using arrow keys (↑↓) select function CONTINUITY 12V/>10A~.
2. Pressing **SET LIMIT/TIME** key twice in a quick succession as well as **CLR** key **LOOP mode** can be set.
3. Press **SET LIMIT/TIME** key twice in a quick succession. The instrument sets under mode for setting type of magneto thermal device which may **Type B** o **Type C**.
4. Using arrow keys (↑↓) select the type of magneto thermal device.
5. Press **SET LIMIT/TIME** key. The instrument stores the current setting of magneto thermal device type and sets under mode for setting rated current of magneto thermal device which may have the following values: **6, 10, 16, 20, 25, 32, 50, 63 A**.
6. Using arrow keys (↑↓) select the rated current of the magneto thermal device.
7. Press **SET LIMIT/TIME** key. The instrument stores the current setting for rated current of the magneto thermal device and sets under starting test mode.

6.5.2. Prospective Short Circuit Current Calculation

The instrument calculated the Prospective short circuit current as:

$$I_{MIN P-PE} = C_{MIN} \cdot \frac{U_{P-PE}^{NOM}}{Z_{P-PE}^{HOT}}$$

Fault to Ground Minimum Prospective Short Circuit Current

Where:

$$Z_{P-PE}^{HOT} = \sqrt{(1.5 \cdot R_{P-PE})^2 + X_{P-PE}^2}$$

and

Voltage	U_{NOM}	C_{MIN}
230V-10% < V _{measured} < 230V+ 10%	230V	0,95
230V+10% < V _{measured} < 400V- 10%	V _{measured}	1,00
400V-10% < V _{measured} < 400V+ 10%	400V	0,95

6.5.3. Run the Test

When the IMP57 has been connected according to paragraph 5.3 and the MASTER instrument has been set according to paragraph 6.5.1 and 6.5.2, you can run the Test by means the **START** button. The **TEST** led turns on indicating that l'IMP57 is testing. During the test the STATUS LED will get Orange colour and when the Test is completed the results will be shown on instrument display.

6.5.4. Test result analysis

The instrument carries out measurement of Phase to Earth line impedance between the two points where IMP57 crocodiles are connected. The result is considered as good (indicated by a brief sound signal bip - bip after completing measurement) or not good (indicated by a long sound which breaks off just pressing **STOP** key) if the value of phase to earth minimum prospective short circuit current is higher or lower than the current limit threshold value I_{lim} . The value of I_{lim} depends on the values set for rated current of magneto thermal device and type of magneto thermal device (see par. 6.5.1).

If necessary, save the result pressing **SAVE** key.

6.5.5. Anomalous results

1. Display of message "**not rdy**" indicates that IMP57 is not reacting the commands sent by FULLTEST4050 through serial interface. Check that FULLTEST4050 is connected to IMP57 by means of C232NG1 cable and that IMP57 is powered (green LED).
2. If after pressing **START** key, the message "**180 Err.**" is displayed and a 3 second long beep sound is emitted, it means that the voltage detected by IMP57 does not reach the minimum preset limit.
3. If after pressing **START** key, the message "**480 Err.**" is displayed and a 3 second long beep sound is emitted, it means that the voltage detected by IMP57 exceeds the preset limit.
4. If after pressing **START** key, the message "**HOT**" is displayed and a 3 second long beep sound is emitted, it means that the temperature probe reached a too high temperature value.
5. If after pressing **START** key, the message "**Curr. Err.**" is displayed and a 3 second long beep sound is emitted, it means that the streaming current is lower than 10A.
6. If after pressing **START** key, the message "**Err. 5**" is displayed and a 3 second long beep sound is emitted, it means that the instrument detects a mistake in data coding by IMP57.
7. If after pressing **START** key, the message "**O.r.**" is displayed and a long beep sound is emitted, breaking off just by pressing **STOP** key, it means that the measured impedance is higher than the maximum impedance value.

7. TEST RESULTS DOWNLOAD

Please see MASTER instrument user's manual for download details.

Always quit the **Z2Ω** High Resolution Measurement mode before attempt the download.

8. MAINTENANCE

8.1. GENERAL

1. The tester you have purchased is a precision instrument. Strictly follow the instructions for use and storage reported in this manual to avoid any possible damage or danger during use.
2. Do not use this tester under unfavourable conditions of high temperature or humidity. Do not expose to direct sunlight.

8.2. INSTRUMENT CLEANING

Use a soft dry cloth to clean the instrument. Never use wet cloths, solvents, water, etc.

8.3. END OF LIFE



CAUTION: this symbol indicates that equipment and its accessories shall be subject to a separate collection and correct disposal.

9. TECHNICAL SPECIFICATIONS

9.1. TECHNICAL FEATURES

Accuracy is indicated as [% of reading + number of digits]. It refers to the following atmospheric conditions: a temperature of $23^{\circ}\text{C} \pm 5^{\circ}\text{C}$ with a relative humidity $< 60\% \text{HR}$.

• IMPEDANCE MEASUREMENT

Range	Resolution	Accuracy
$0.1 \div 199.9 \text{m}\Omega^{(*)}$	0.1m Ω	$\pm (5\% \text{ reading} + 1 \text{m}\Omega)$
$200 \div 1999 \text{m}\Omega$	1m Ω	

(*) Max test current 202A

• RESISTANCE AND REACTANCE MEASUREMENT (for Type 1 and Type 3 instr. only – see table 1 pag. 8)

Range	Resolution	Accuracy
$0.1 \div 199.9 \text{m}\Omega^{(*)}$	0.1m Ω	$\pm (10\% \text{ reading} + 2 \text{m}\Omega)$
$200 \div 1999 \text{m}\Omega$	1m Ω	

(*) Max test current 202A

• PROSPECTIVE SHORT CIRCUIT CURRENT

Range	Resolution	Accuracy
$0 \div 1999 \text{A}$	1A	related to Z accuracy and relationship of paragraph 6.1.2 and 6.2.2 and 6.3.2 and 6.4.2
$2.0 \div 9.9 \text{kA}$	0.1kA	
$10 \div 1999 \text{kA}$	1kA	

• VOLTAGE

Range (50Hz $\pm 5\%$)	Resolution	Accuracy
$190 \div 460 \text{V}$	1V	$\pm (1.0\% \text{ reading} + 2 \text{digit})$

• FREQUENCY

Range	Resolution	Accuracy
$47.5 - 52.5 \text{Hz}$	0.1Hz	$\pm 0.2 \text{Hz}$

9.1.1. Safety Guidelines:

- IMP57 comply with: EN 61010, EN61557
- Insulation: Class 2, Double Insulation
- Pollution degree: 2
- max altitude: 2000m
- Overvoltage category: CAT III 240V (to ground)
CAT III 415V (between inputs P1, C1, P2, C2)

9.1.2. Safety standards

The instrument complies with CEI 64.8 612.6.3, EN61557-3, EN60909-0, VDE 0413

9.1.3. General Characteristics

- Dimensions: 340mm (L) x 300mm (W) mm x 150mm (H)
- Weigh: approx.4100g (without accessories)

Power Supply

- Nominal Voltage: $220 \div 415 \text{V}$ (between P1 and P2)
- Frequency: $50 \text{Hz} \pm 5\%$

9.2. ENVIRONMENT

9.2.1. Environmental condition

Reference temperature:	23°C ± 5°C
Operating temperature:	0°C ÷ 40°C
Allowed relative humidity:	<80%HR
Storage temperature:	-10°C ÷ 60°C
Storage humidity:	<80%HR

This product conforms to the prescriptions of the European directive on low voltage 2006/95/EEC (LVD) and to EMC directive 2004/108/EEC

9.3. ACCESSORIES

- C7000: 2 measuring cables (L=3m) with alligator clip
- C2001: optical cable for communication
- B80: carrying bag for test leads
- ISO9000 calibration certificate
- CD-ROM for MASTER Instrument upgrading
- User manual

10. SERVICE

10.1. WARRANTY

This instrument is guaranteed against any defect in material and manufacturing in compliance with the general sales terms and conditions. Throughout the period of guarantee all defective parts may be replaced and the manufacturer reserves the right to repair or replace the product.

If the instrument is to be returned to the after-sales service or to a dealer transportation costs are on the customer's behalf. Shipment shall be however agreed upon.

A report must always be enclosed to a rejected product stating the reasons of its return.

To ship the instrument use only the original packaging material; any damage that may be due to no-original packing shall be charged to the customer.

The manufacturer declines any responsibility for damages caused to persons and/or objects.

Warranty is not applied in the following cases:

- Any repair and/or replacement of accessories (not covered by the guarantee).
- Any repair that might be necessary as a consequence of a misuse of the instrument or of its use with no compatible devices.
- Any repair that might be necessary as a consequence of improper packaging.
- Any repair that might be necessary as a consequence of service actions carried out by unauthorised personnel.
- Any modification of the instrument carried out without the authorisation of the manufacturer.
- Use not provided for in the instrument's specifications or in the instruction manual.

The content of this manual cannot be reproduced in any form whatsoever without prior authorisation of the manufacturer.

All our products are patented and their trade marks registered. The manufacturer reserves the right to modify the product specifications and prices if this is aimed at technological improvements.

10.2. SERVICE

If the instrument does not operate properly, before contacting the after-sales service check cables as well as test leads and replace them if necessary.

Should the instrument still operate improperly check that the operation procedure is correct and conforms with the instructions given in this manual.

If the instrument is to be returned to the after-sales service or to a dealer transportation costs are on the customer's behalf. Shipment shall be however agreed upon.

A report must always be enclosed to a rejected product stating the reasons of its return.

To ship the instrument use only the original packaging material; any damage that may be due to no-original packing shall be charged to the customer.