



ENGLISH

User manual



TABLE OF CONTENTS

1. PRECAUTIONS AND SAFETY MEASURES	2
1.1. Preliminary instructions	2
1.2. During use	2
1.3. After use	2
2. GENERAL DESCRIPTION	3
3. PREPARATION FOR USE	3
3.1. Initial checks	3
3.2. Instrument power supply	3
3.3. Storage	3
4. NOMENCLATURE	4
4.1. Description of the front part of the instrument	4
4.2. Description of the instrument's side	4
4.3. Description of the external probe	5
4.4. Description of function keys	6
4.4.1. Key ON/OFF	6
4.4.2. Key Bright	6
4.4.3. Key  (Zoom)	6
4.4.4. Key  (Rotate)	6
4.4.5. Key RESET	6
5. OPERATING INSTRUCTIONS	7
5.1. Using the instrument	7
6. MAINTENANCE	8
6.1. General information	8
6.2. Battery recharge	8
6.3. Cleaning the instrument	8
6.4. End of life	8
7. TECHNICAL SPECIFICATIONS	9
7.1. Technical characteristics	9
7.2. General characteristics	9
7.3. Environment	9
7.3.1. Environmental conditions for use	9
7.4. Accessories	9
7.4.1. Accessories provided	9
7.4.2. Accessories provided	9
8. ASSISTANCE	10
8.1. Warranty conditions	10
8.2. Assistance	10

1. PRECAUTIONS AND SAFETY MEASURES

The instrument has been designed in compliance with the safety directive relevant to electronic measuring instruments. In order to prevent damaging the instrument, please carefully follow the procedures described in this manual and read all notes preceded by symbol  with the utmost attention. Before and after carrying out measurements, carefully observe the following instructions:

- Do not carry out any measurements in case gas, explosive materials or flammables are present, or in humid or dusty environments.
- Do not carry out any measurement in case you find anomalies in the instrument such as deformation, substance leaks, absence of display on the screen, etc.

In this manual, and on the instrument, the following symbols are used:



Caution: observe the instructions given in this manual. Improper use may damage the instrument or its components.



Make sure not to damage/interrupt the external probe in order to carry out normal operations.



Make sure not to crush/squeeze the external probe in order to carry out normal operations.

1.1. PRELIMINARY INSTRUCTIONS

- We recommend following the normal safety rules devised to protect the user against dangerous situations and the instrument against incorrect use.
- Only the accessories provided together with the instrument will guarantee safety standards. They must be used only if in good conditions and replaced with identical models, when necessary.
- Check that the battery is correctly inserted.

1.2. DURING USE

Please carefully read the following recommendations and instructions:



CAUTION

Failure to comply with the caution notes and/or instructions may damage the instrument and/or its components or be a source of danger for the operator.

- Use the instrument and the external probe as instructed in this manual.
- Should the instrument remain blocked and not function properly during use, please press the **RESET** key (see § Fig. 2)

1.3. AFTER USE

- When operations are complete, switch off the instrument.
- If you expect not to use the instrument for a long period, remove the battery.

2. GENERAL DESCRIPTION

Model HTB500 is a portable digital borescope which allows carrying out inspections inside parts of objects not physically accessible (typically rotating equipment) and not visible to the naked eye. The instrument uses a waterproof external probe with 4 LEDs with high brightness and a camera, in order to obtain a high-resolution image on the display.

The instrument's characteristics are the following:

- Real-time display of the item
- Waterproof flexible external probe (IP67)
- Built-in white-light LEDs for operations in poorly lit environments
- Image rotation (0° - 180°) on the display
- Adjustment of brightness
- Rechargeable Li-ION battery
- USB input for battery recharge
- Analog video output (PAL/NTSC) for the connection to external devices
- Electronic image zoom

3. PREPARATION FOR USE

3.1. INITIAL CHECKS

Before shipping, the instrument has been checked from an electric as well as mechanical point of view. All possible precautions have been taken so that the instrument is delivered undamaged. However, we recommend generally checking the instrument in order to detect possible damage suffered during transport. In case anomalies are found, immediately contact the forwarding agent. We also recommend checking that the packaging contains all components indicated in § 7.4.1. In case of discrepancy, please contact the Dealer. In case the instrument should be returned, please follow the instructions given in § 8.

3.2. INSTRUMENT POWER SUPPLY

The instrument is powered by 1x3.7V rechargeable 2000mAh Li-ION battery included in the package. The  symbol appears on the display when the battery is flat. Recharge the battery by following the instructions given in § 6.2.

3.3. STORAGE

In order to guarantee precise measurement, after a long storage time under extreme environmental conditions, wait for the instrument to come back to normal operating conditions (see § 7.3.1).

4. NOMENCLATURE

4.1. DESCRIPTION OF THE FRONT PART OF THE INSTRUMENT

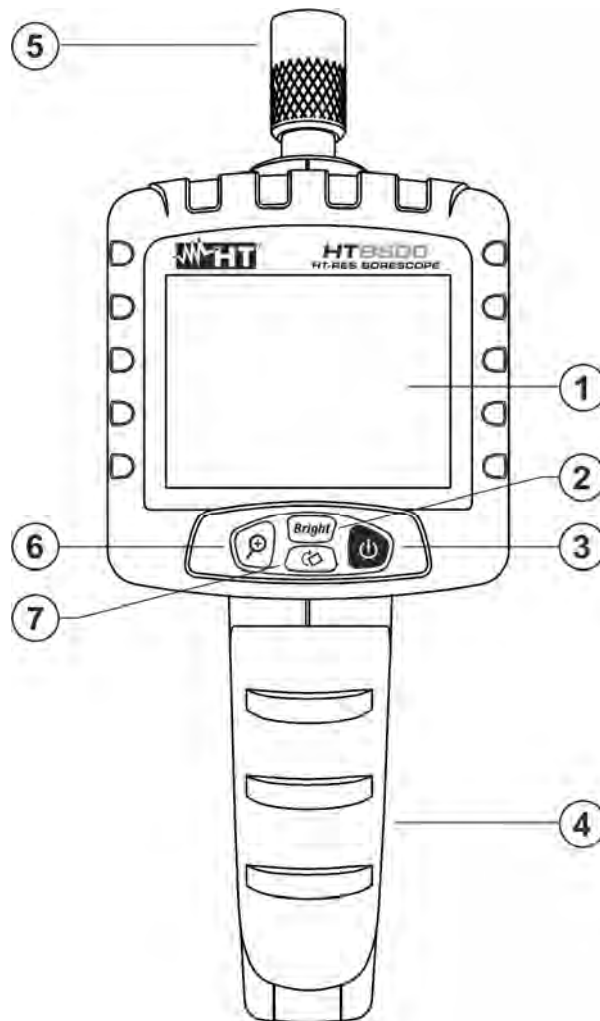

CAPTION:

1. LCD display
2. Key **Bright**
3. Key **ON/OFF**
4. Battery compartment cover
5. Input terminal for external probe
6. Key (**Zoom**)
7. Key (**Rotate**)

Fig. 1: Description of the front part of the instrument

4.2. DESCRIPTION OF THE INSTRUMENT'S SIDE

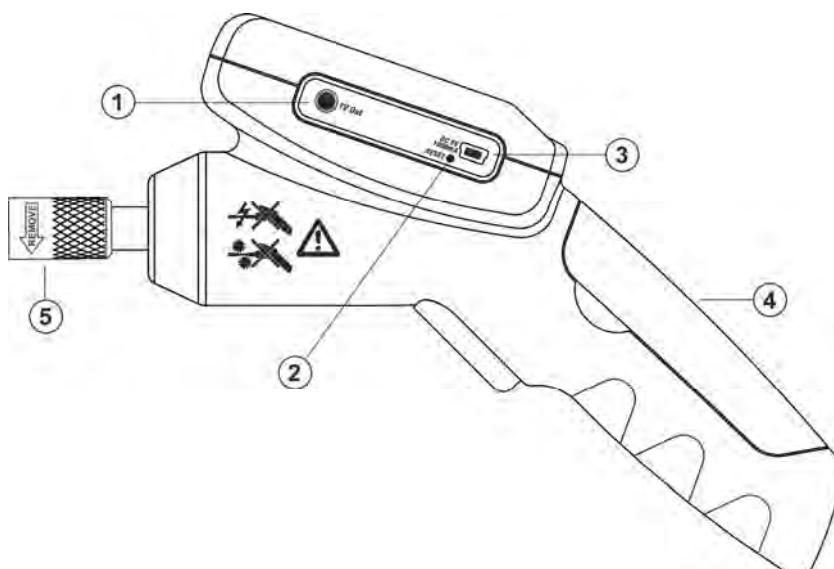

CAPTION:

1. Video output (TV)
2. Key **RESET**
3. USB input for battery recharge
4. Battery compartment cover
5. Input terminal for external probe

Fig. 2: Description of the instrument's side

4.3. DESCRIPTION OF THE EXTERNAL PROBE

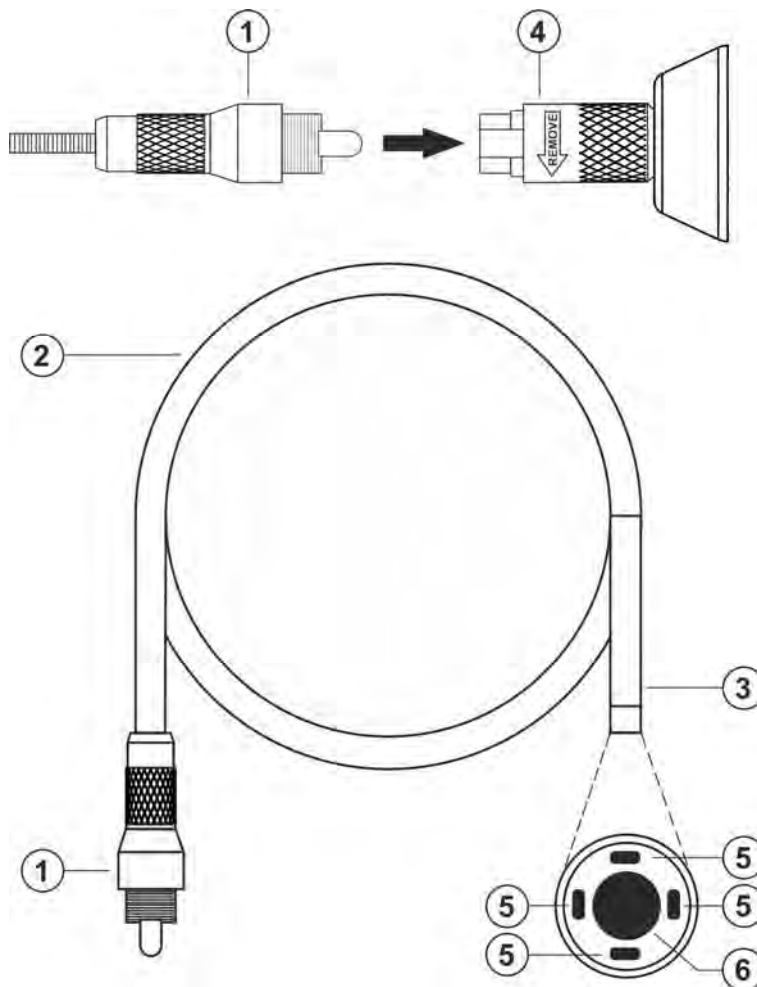

CAPTION:

1. Male terminal for the connection of the probe to the instrument
2. Flexible external probe
3. Probe terminal with built-in camera
4. Female terminal for the connection of the probe to the instrument
5. White-light LEDs
6. Built-in photo camera

Fig. 3: Description of the external probe

4.4. DESCRIPTION OF FUNCTION KEYS

4.4.1. Key ON/OFF

Pressing key **ON/OFF** allows turning on/off the instrument. Upon start-up, with disconnected external probe, the instrument only shows an empty screen with the symbol of the battery charge level.

4.4.2. Key Bright

Pressing key **Bright** allows adjusting the brightness of the white-light LEDs on the end of the external probe (see Fig. 3 – part 5) **up to 10 levels**. The following screen appears on the display for a moment.

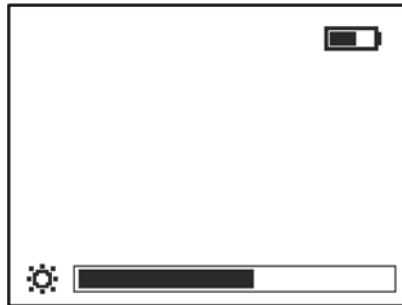

Fig. 4: Setting of brightness levels of the probe's LEDs

4.4.3. Key (Zoom)



Pressing key  allows the zooming of the image on the display from **1.0x ÷ 2.0x** by steps of 0.2x. The following screen appears on the display:



Fig. 5: Setting of the display image zooming

4.4.4. Key (Rotate)

Pressing key  allows rotating the image on the display, switching to a 180° view (see Fig. 6).

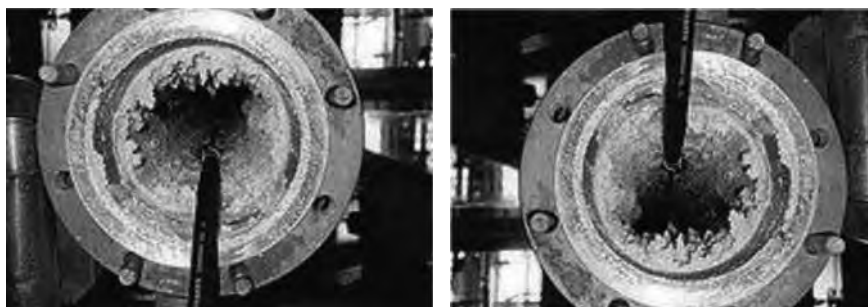

Image 0° Image 180°
Fig. 6: Image rotation on the display

4.4.5. Key RESET

Pressing key **RESET** (see Fig. 2 – part 2) allows resetting the internal system by switching the instrument off and on again.

5. OPERATING INSTRUCTIONS

5.1. USING THE INSTRUMENT



CAUTION

- Use the instrument in dry environments or with low humidity levels, respecting the instructions given with the technical specifications in order to avoid any damage.
- Only the probe's built-in photo camera is fully waterproof.
- Do not expose the photo camera to sunlight or to external probes which may reflect light onto it during operations.
- Handle with care.

1. Insert the rechargeable battery into the relevant compartment (see Fig. 2 – part 4), connecting it as shown in Fig. 7



Fig. 7: Connecting the battery to the instrument

2. Insert the external probe into the instrument (see Fig. 3 - parts 1 and 4) and fasten it by screwing in the connector (see Fig. 2 – part 5).
3. Switch on the instrument using key **ON/OFF**. The white-light LEDs of the probe switch on and the image of the framed item appears on the display. Move the probe to the desired position.
4. To use the functions **Bright**, **Zoom** and **Rotate**, please refer to § 4.4
5. In case you want to use the instrument together with an external device, please connect the TV video output (**PAL/NTSC type**) of the instrument (see Fig. 2 – part 1) through a standard video cable. The instrument automatically recognizes the presence of a PAL or NTSC system.
6. Switch off the instrument using key **ON/OFF**.

6. MAINTENANCE

6.1. GENERAL INFORMATION

1. While using and storing the instrument, carefully observe the recommendations listed in this manual in order to prevent possible damage or danger during use.
2. Do not use the instrument in environments with high humidity levels or high temperatures. Do not expose to direct sunlight.
3. Always switch off the instrument after use.





6.2. BATTERY RECHARGE

When the display shows symbol "", it is necessary to replace the battery.



CAUTION

Only expert technicians should perform this operation. Before carrying out this operation, make sure you have removed the probe from the input terminal.

1. Switch off the instrument and remove the probe from the input terminal.
2. Connect the provided USB cable to the USB input of the instrument (see Fig. 2 – part 3) and the other end of the cable to a USB port of the PC, regularly switched on.
3. The recharging process starts and the following icons "  " are shown in a sequence on the display:
4. At the end of the recharging process, the icon "" appears fixed on the display.
5. When necessary, replace the battery. Do not discard the used one into the environment. Use the relevant containers for battery disposal.

6.3. CLEANING THE INSTRUMENT

Use a soft and dry cloth to clean the instrument. Never use wet cloths, solvents, water, etc.

6.4. END OF LIFE



WARNING: this symbol found on the instrument indicates that the appliance, its accessories and the battery must be collected separately and correctly disposed of.

7. TECHNICAL SPECIFICATIONS

7.1. TECHNICAL CHARACTERISTICS

External camera

Sensor size:	¼in (CMOS), 300.000pxl
Max sensor resolution:	640x480pxl
Max sampling frequency:	30FPS/S
Colour depth:	24bit
Image focusing:	fixed (5cm ÷ 15cm) (2.0in ÷ 5.9in)
External probe length:	1m (39in)
Camera diameter:	6mm (0.2in)
Camera light:	4 white-light LEDs
Adjustment of brightness:	10 levels

7.2. GENERAL CHARACTERISTICS

Mechanical characteristics

Dimensions (L x W x H):	250 x 100 x 95mm (10 x 4 x 4in)
Weight (battery included):	345g (12 ounces)
Mechanical protection:	IP54 (instrument), IP67 (external probe)

Power supply

Battery type:	1x3.7V rechargeable Li-ION battery, 2000mAh
Low battery indication:	symbol "  " on the display
Battery life:	approx. 5 hours (stand-by)
Recharging time:	approx. 8 hours (USB interface)

Interface

Video output:	PAL/NTSC
Power supply input:	mini USB (5VDC, 1000mA)

Display

Characteristics:	colour, LCD-TFT, 3.5", 640x320pxl
------------------	-----------------------------------

7.3. ENVIRONMENT

7.3.1. Environmental conditions for use

Operating temperature:	0°C ÷ 50°C (32°F ÷ 122°F)
Allowable relative humidity:	<85%RH
Storage temperature:	-20°C ÷ 60°C (-4°F ÷ 140°F)
Storage humidity:	<85%RH
Max operating altitude:	2000m (6562ft)

<p>This instrument complies with European Directive EMC 2014/30/EU This instrument satisfies the requirements of European Directive 2011/65/EU (RoHS) and 2012/19/EU (WEEE).</p>
--

7.4. ACCESSORIES

7.4.1. Accessories provided

- Flexible external probe, L=1m, D=6mm
- Rechargeable Li-ION battery
- USB cable for battery recharge
- Carrying bag
- User manual

7.4.2. Accessories provided

- Flexible external probe, L=3m, D=6mm

Cod: BP36

8. ASSISTANCE

8.1. WARRANTY CONDITIONS

This instrument is warranted against any material or manufacturing defect, in compliance with the general sales conditions. During the warranty period, defective parts may be replaced. However, the manufacturer reserves the right to repair or replace the product. Should the instrument be returned to the After-sales Service or to a Dealer, transport will be at the Customer's charge. However, shipment will be agreed in advance. A report will always be enclosed to a shipment, stating the reasons for the product's return. Only use original packaging for shipment; any damage due to the use of non-original packaging material will be charged to the Customer. The manufacturer declines any responsibility for injury to people or damage to property.

The warranty shall not apply in the following cases:

- Repair and/or replacement of accessories and batteries (not covered by warranty)
- Repairs that may become necessary as a consequence of an incorrect use of the instrument or due to its use together with non-compatible appliances.
- Repairs that may become necessary as a consequence of improper packaging.
- Repairs which may become necessary as a consequence of interventions performed by unauthorized personnel.
- Modifications to the instrument performed without the manufacturer's explicit authorization.
- Use not provided for in the instrument's specifications or in the instruction manual.

The content of this manual cannot be reproduced in any form without the manufacturer's authorization.

Our products are patented and our trademarks are registered. The manufacturer reserves the right to make changes in the specifications and prices if this is due to improvements in technology.

8.2. ASSISTANCE

If the instrument does not operate properly, before contacting the After-sales Service, please check the conditions of the battery and replace it, if necessary. Should the instrument still operate improperly, check that the product is operated according to the instructions given in this manual. Should the instrument be returned to the After-sales Service or to a Dealer, transport will be at the Customer's charge. However, shipment will be agreed in advance. A report will always be enclosed to a shipment, stating the reasons for the product's return. Only use original packaging for shipment; any damage due to the use of non-original packaging material will be charged to the Customer.