



UK
CA
CE

GSC60

User manual



TABLE OF CONTENTS

1. PRECAUTIONS AND SAFETY MEASURES3

1.1. Preliminary instructions 3

1.2. During use 4

1.3. After use 4

1.4. Definition of measurement (overvoltage) category 4

2. GENERAL DESCRIPTION 5

2.1. Foreword 5

3. PREPARATION FOR USE 6

3.1. Initial checks 6

3.2. Instrument power supply 6

3.3. Storage 6

4. NOMENCLATURE 7

4.1. Instrument description 7

4.2. Description of measuring leads 7

4.3. Keyboard description 8

4.4. Display description 8

4.5. Initial screen 8

5. GENERAL MENU 9

5.1. Instrument settings 9

5.1.1. Language 9

5.1.2. Reference country 10

5.1.3. Automatic Power OFF for display and key sound 10

5.1.4. System 10

5.1.5. Operator name entry 11

5.1.6. System date/time setting 11

5.2. Information 11

6. OPERATING INSTRUCTIONS 12

6.1. RPE: Continuity of protective conductors 12

6.1.1. Anomalous situations 15

6.2. MΩ: Measurement of insulation resistance 16

6.2.1. Anomalous situations 19

6.3. RCD: Test on differential switches 20

6.3.1. AUTO mode 24

6.3.2. x¹/₂, x1, x2, x5 modes 25

6.3.3. Mode x1 – Test on RCDs with delay time 25

6.3.4. Mode  26

6.3.5. Test on earth leakage relay RCD 27

6.3.6. Anomalous situations 28

6.4. LOOP: Line impedance/Loop and overall earth resistance 31

6.4.1. Test types 33

6.4.2. STD Mode – Generic test 35

6.4.3. Mode kA – Verify of breaking capacity of protection device 37

6.4.4. Mode I²t – Verify of protection against short-circuit 39

6.4.5. Mode  - Verify of protection coordination 42

6.4.6. Mode  - Verify of protection coordination – Norway country 44

6.4.7. Verify of protection against indirect contacts (TN system) 46

6.4.8. Verify of protection against indirect contacts (IT systems) 48

6.4.9. Verify of protection against indirect contacts (TT systems) 49

6.4.10. Impedance measurement by means of the accessory IMP57 51

6.4.11. Anomalous situations 53

6.5. SEQ: Phase sequence and phase concordance test 55

6.5.1. Anomalous situations 58

6.6. LEAKAGE: Leakage current measurement and recording 59

6.7. EARTH: Measurement of earth resistance 62

6.7.1. 3-wire or 2-wire earth measurement and 4-wire ground resistivity 62

6.7.2. 3-wire or 2-wire earth measure – USA, Extra Europe and Germany countries 68

6.7.3. Earth measurement with optional clamp T2100 71

6.7.4.	Anomalous situations in 3-wire and 2-wire earth measurements	74
6.8.	AUX: Measure and recording of ambient parameters	75
6.9.	$\Delta V\%$: Voltage drop of main lines	78
6.9.1.	Anomalous situations	82
6.10.	PQA: Measurement and recording of main parameters	84
6.10.1.	Connections types	84
6.10.2.	General settings	88
6.10.3.	Display of measurements	90
6.10.4.	Start recording	92
6.11.	List of message at display	94
7.	OPERATIONS WITH THE MEMORY	95
7.1.	Saving measurements	95
7.1.1.	Saving safety tests and snapshots	95
7.1.2.	Recall and delete safety measurements and snapshots	96
7.1.3.	Recall and delete saved recordings	97
7.1.4.	Anomalous situations	98
8.	CONNECTING THE INSTRUMENT TO A PC OR MOBILE DEVICES	99
8.1.	Connection to iOS/Android devices through WiFi	99
9.	USE OF STRAP SET	100
10.	MAINTENANCE	103
10.1.	General information	103
10.2.	Recharging and replacement of the batteries	103
10.3.	Cleaning the instrument	103
10.4.	End of life	103
11.	TECHNICAL SPECIFICATIONS	104
11.1.	Technical characteristics safety section	104
11.2.	Technical characteristics PQA section	109
11.3.	Reference guidelines	111
11.4.	General characteristics	111
11.5.	Environment	112
11.5.1.	Environmental conditions for use	112
11.6.	Accessories	112
12.	SERVICE	113
12.1.	Warranty conditions	113
12.2.	Service	113
13.	THEORETICAL APPENDIXES	114
13.1.	Continuity of protective conductors	114
13.2.	Insulation resistance	115
13.3.	Checking circuit separation	116
13.4.	Test on differential switches (RCD)	118
13.5.	Verify of the breaking capacity of protection devices	119
13.6.	Verify of protection against indirect contacts in TN systems	120
13.7.	Verify of protection against indirect contacts in TT systems	122
13.8.	Verify of protection against indirect contacts in IT systems	123
13.9.	Verify of protection coordination L-L, L-N and L-PE	124
13.10.	Verify of the protection against short circuits – Test I _{2t}	126
13.11.	Verification of voltage drop on main lines	127
13.12.	Measurement of earth resistance in TN systems	128
13.13.	Voltage Anomalies	133
13.14.	Voltage and current Harmonics	134
13.15.	Definitions of powers and power factors	137
13.16.	Measuring method: outlines	140
13.17.	Description of typical configurations	141

1. PRECAUTIONS AND SAFETY MEASURES

The instrument is been designed in compliance with directives IEC/EN61557 and IEC/EN61010-1, relevant to electronic measuring instruments. Before and after carrying out measurements, carefully observe the following instructions:

- Do not carry out any voltage or current measurement in humid environments.
- Do not carry out any measurements in case gas, explosive materials or flammables are present, or in dusty environments.
- Avoid any contact with the circuit being measured if no measurements are being carried out.
- Avoid contact with exposed metal parts, with unused measuring probes, etc.
- Do not carry out any measurement in case you find anomalies in the instrument such as deformations, breaks, substance leaks, absence of display on the screen, etc.
- Pay special attention when measuring voltages higher than 25V in special environments (such as construction sites, swimming pools, etc.) and higher than 50V in normal environments, since a risk of electrical shock exists.
- Only use original HT accessories.

The following symbols are used in this manual:



CAUTION: observe the instructions given in this manual; improper use could damage the instrument, its components or create dangerous situations for the operator.



High voltage danger: electrical shock hazard.



Double insulation



AC voltage or current



DC voltage or current



Connection to earth

1.1. PRELIMINARY INSTRUCTIONS

- This instrument has been designed for use in the environmental conditions specified in § 11.5.1. Do not use in different environmental conditions.
- The instrument may be used for measuring and verifying the safety of electrical systems. Do not use on systems exceeding the limit values specified in § 11.4.
- We recommend following the normal safety rules devised to protect the user against dangerous currents and the instrument against incorrect use.
- Only the accessories supplied with the instrument (**in particular the external adapter A0061**) guarantee compliance with safety standards. They must be in good conditions and be replaced with identical models, when necessary.
- Make sure the batteries are correctly installed.
- Before connecting the test leads to the circuit being measured, check that the desired function has been selected

1.2. DURING USE

Please carefully read the following recommendations and instructions:



CAUTION

Failure to comply with the caution notes and/or instructions may damage the instrument and/or its components or be a source of danger for the operator.

- Before changing function, disconnect the test leads from the circuit under test.
- When the instrument is connected to the circuit under test, never touch any terminal, even if unused.
- Avoid measuring resistance if external voltages are present. Even if the instrument is protected, excessive voltage could cause damage.
- While measuring current, place the clamp jaws as far as possible from the conductors not involved in the measurement, as the magnetic field they produce could interfere with the measuring operations and place the conductor as much as possible in the center of the jaws to maximize accuracy.

1.3. AFTER USE

When measurements are completed, turn off the instrument by pressing and holding the **ON/OFF** key for some seconds. If the instrument is not to be used for a long time, remove the batteries and follow the instructions given in § 3.3.

1.4. DEFINITION OF MEASUREMENT (OVERVOLTAGE) CATEGORY

Standard "IEC/EN61010-1: Safety requirements for electrical equipment for measurement, control and laboratory use, Part 1: General requirements" defines what measurement category, commonly called overvoltage category, is. § 6.7.4: Measured circuits, reads: circuits are divided into the following measurement categories:

- **Measurement Category IV** is for measurements performed at the source of a low-voltage installation.
Examples are electricity meters and measurements on primary overcurrent protection devices and ripple control units.
- **Measurement Category III** is for measurements performed on installations inside buildings.
Examples are measurements on distribution boards, circuit breakers, wiring, including cables, bus-bars, junction boxes, switches, socket-outlets in fixed installation, and equipment for industrial use and some other equipment, for example, stationary motors with permanent connection to fixed installation.
- **Measurement Category II** is for measurements performed on circuits directly connected to the low-voltage installation.
Examples are measurements on household appliances, portable tools and similar equipment.
- **Measurement Category I** is for measurements performed on circuits not directly connected to MAINS.
Examples are measurements on circuits not derived from MAINS, and specially protected (internal) MAINS-derived circuits. In the latter case, transient stresses are variable; for that reason, the standard requires that the transient withstand capability of the equipment is made known to the user.

2. GENERAL DESCRIPTION

2.1. FOREWORD

The instrument is equipped with a TFT color LCD display, with capacitive "touch-screen" that can be handled simply with the touch of a finger by the user and is structured with an icon-based menu allowing the direct selection of measurement functions for quick and intuitive use.

The instrument can perform the following tests:

RPE	Continuity test of earth, protective and equipotential conductors with test current higher than 200mA and open-circuit voltage between 4V and 24V
MΩ	Measurement of insulation resistance with continuous test voltage of 50V, 100V, 250V, 500V or 1000V DC
RCD	Test on molded case RCD (Standard – STD) and on earth leakage relay RCD (🔌) General (G), Selective (S) and Delayed (⏸) of type A/F (⚡) AC(~) and B/B+(⚡*) of the following parameters: tripping time, tripping current, contact voltage
LOOP	Measurement of line impedance/Loop L-N, L-L, L-PE with calculation of the assumed short-circuit current, also with high resolution (0.1mΩ) (by means of optional accessory IMP57), overall earth resistance without causing the RCD tripping, check of the interruption capacity of magnetothermal protections (MCB) and fuses, I2t test, protection check in case of indirect contacts
EARTH	Measurement of earth impedance and ground resistivity by voltammetric method and by an external clamp connected to the instrument (optional accessory T2100)
SEQ	Indication of phase sequence with 2- or 1-terminal method
AUX	Measurement and recording of environmental parameters (illuminance, air temperature, humidity) by means of optional external probes and DC voltage signals
LEAKAGE	Measurement and recording of leakage current (by means of the optional transducer clamp HT96U)
ΔV%	Measurement of percentage voltage drop on main lines
PQA	Real-time measurement and recording of mains parameters, harmonic analysis, voltage anomalies (sags, swells), power/energy consumption in single-phase and three-phase generic systems

3. PREPARATION FOR USE



3.1. INITIAL CHECKS

Before shipping, the instrument has been checked from an electric as well as mechanical point of view. All possible precautions have been taken so that the instrument is delivered undamaged. However, we recommend checking it to detect any damage possibly suffered during transport. In case anomalies are found, immediately contact the Dealer.

We also recommend checking that the packaging contains all the components indicated in § 11.6. In case of discrepancy, please contact the Dealer. In case the instrument should be returned, please follow the instructions given in § 12.

3.2. INSTRUMENT POWER SUPPLY

The instrument is powered by 6x1.2V NiMH rechargeable batteries type AA LR06 supplied with the instrument or by 6x1.5V alkaline batteries type AA LR06. Rechargeable batteries must be recharged by using the external charger A0061, also provided with the instrument.

The green “” symbol indicates a sufficient charge level for the correct performance of the tests. The red “” symbol indicates an insufficient charge level for the correct performance of the tests. In this case, recharge the batteries (see § 10.2).

CAUTION



- If the external adapter is used, it is necessary to connect it first to the instrument, then to the mains, then please connect the instrument to the circuit to be tested
- The external adapter A0061 can be used both for verification tests (SAFETY) and for network analyses (PQA)
- While recording it is recommended to use both the external adapter and the rechargeable batteries, in order to guarantee the instrument's supply in case of voltage interruption
- With low battery indication, stop the tests and recharge or replace the batteries (see § 10.2)
- **The instrument is capable of keeping data stored even without batteries**
- The instrument has an AutoPower OFF function (which can be deactivated) after 5 minutes' idling (the Auto Power OFF is inactive while recording – see § 5.1.3)

3.3. STORAGE

In order to guarantee precise measurement, after a long storage time under extreme environmental conditions, wait for the instrument to come back to normal condition (see § 11.5.1).

4. NOMENCLATURE

4.1. INSTRUMENT DESCRIPTION

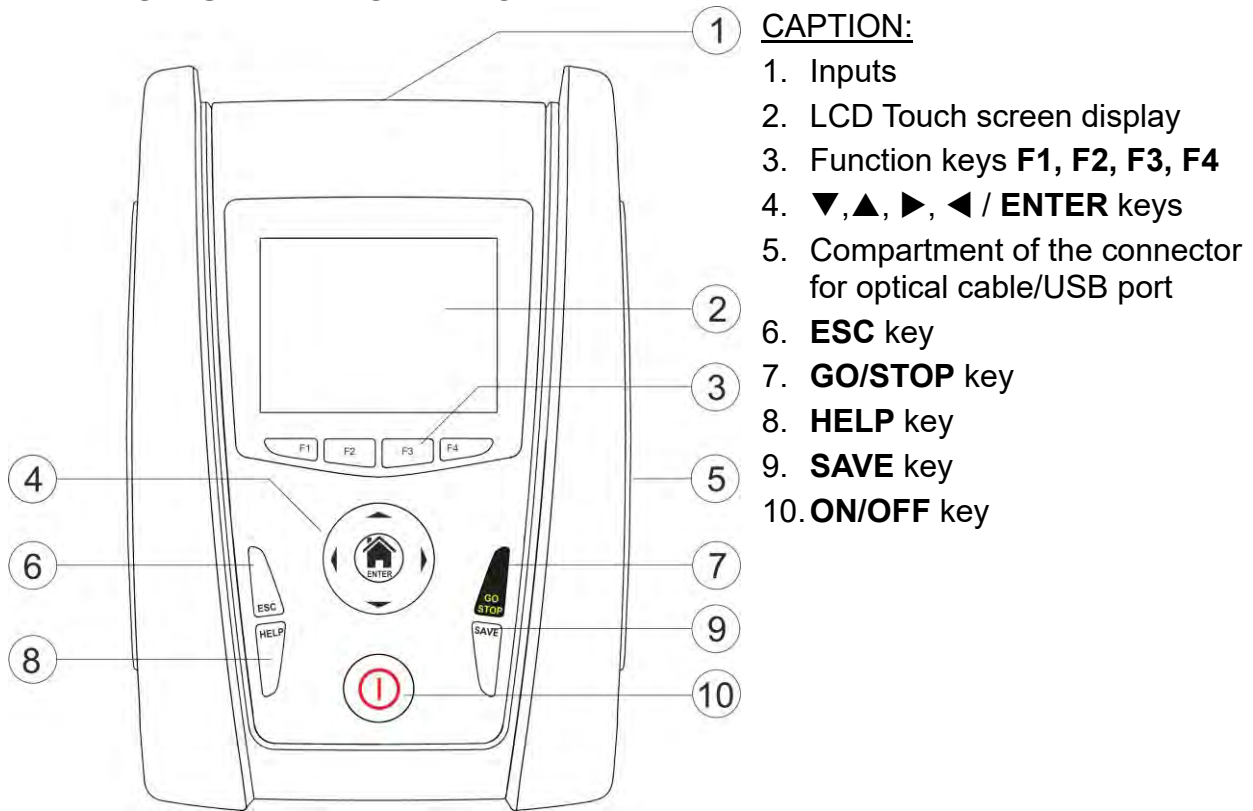

Fig. 1: Description of the front part of the instrument

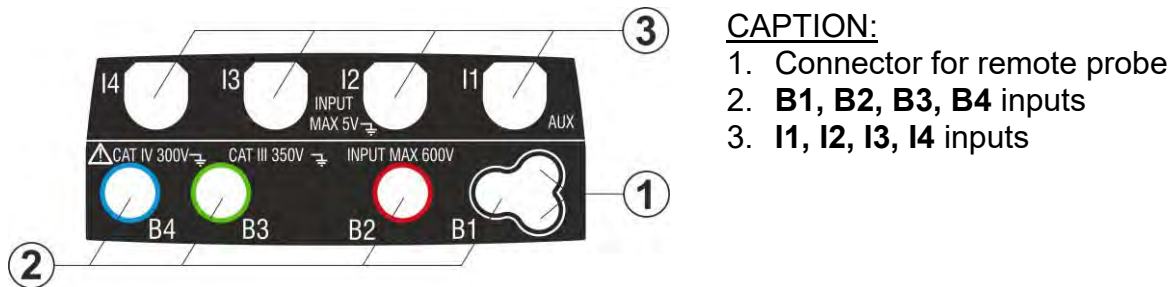

Fig. 2: Description of the upper part of the instrument

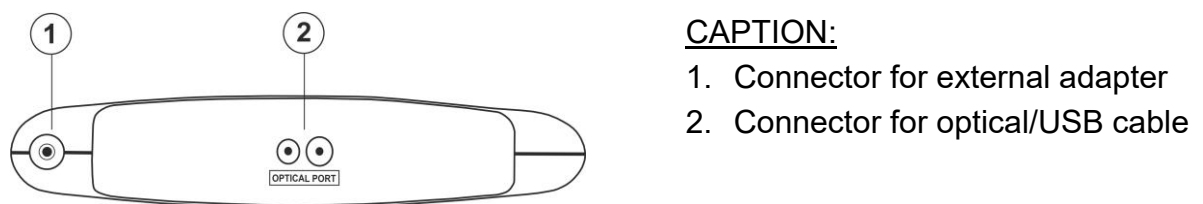

Fig. 3: Description of the instrument's side

4.2. DESCRIPTION OF MEASURING LEADS

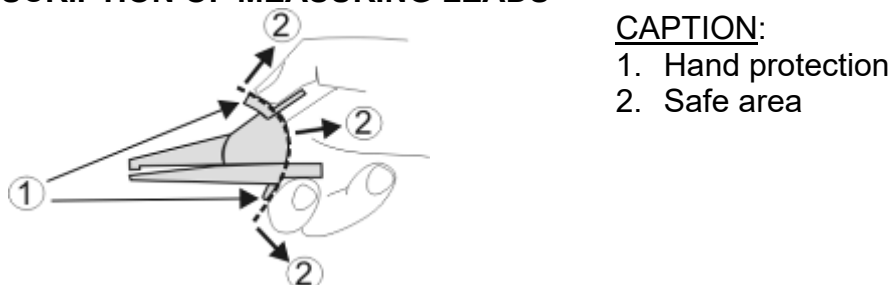

Fig. 4: Description of measuring leads

4.3. KEYBOARD DESCRIPTION

The keyboard includes the following keys:



ON/OFF key to switch on/off the instrument



ESC key to exit the selected menu without confirming



◀ ▶ ▲ ▼ keys to move the cursor through the different screens in order to select the desired programming parameters

HOME  / **ENTER** key to back to general Menu on each moment



GO/STOP key to start the measurement



SAVE key to save the measured values



HELP key to access the online help and display the possible connections between the instrument and the system for each selected function

F1, F2, F3, F4 Function keys corresponding to the activation of the four icons on the bottom of the screen as an alternative to direct touch on the display

4.4. DISPLAY DESCRIPTION

The display is an LCD, 320x240pxl TFT color display with capacitive touch screen whose icon-structure can be directly selected with a simple touch. The first line of the display indicates the type of active measurement, the date/time and the battery charge indication.



4.5. INITIAL SCREEN

When switching on the instrument, the initial screen appears for a few seconds. It shows:

- The HT manufacturer's logo
- The instrument model
- The Firmware version (LCD and CPU)
- The serial number (SN:) of the instrument
- The date of instrument calibration (Calibration date:)



After a few seconds, the instrument switches to the general menu.

5. GENERAL MENU

Pressing the **ENTER** key in any condition of the instrument allows to go back to the general menu in which internal parameters may be set, the saved measures can be displayed and the desired measuring function may be selected.

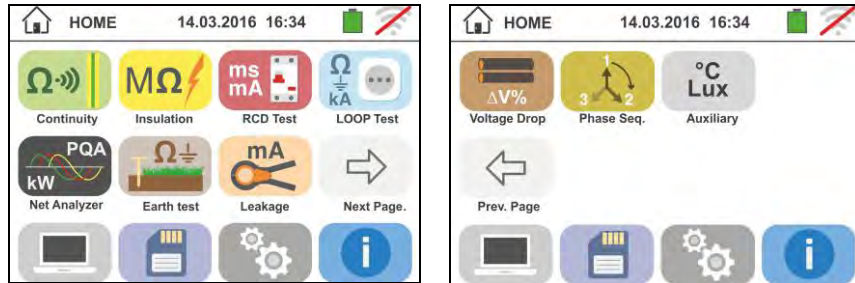

Fig. 5: General menu of the instrument

Touch the icon to move to the following page of the general menu and the icon to go back to the previous page. Inside the screens, touch the icon to confirm a selection or the icon to exit without confirming.

5.1. INSTRUMENT SETTINGS

Touch the icon. The screen to the side appears on the display. The following settings are available:

- System language setting
- Setting of the type of electrical system
- Setting of the country
- Operator name setting
- System date/time setting
- Activation/deactivation of display AutoPower OFF and of key sound



Settings will be maintained also after switching off the instrument.

5.1.1. Language

Touch the icon to select the system language. The screen to the side appears on the display.

Select the desired language, confirm the choice and return to the previous screen.



5.1.2. Reference country



Touch the icon to select the reference country. This choice have influence on the LOOP and EARTH measurements (see § 6.4 and § 6.7) as shown in Table 1. The screen to the side appears on the display.

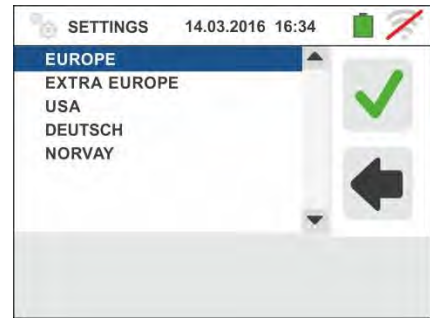

Select the desired country, confirm the choice and return to the previous screen

		Europe	Extra Europe	USA	Germany	Norway
LOOP	TT	Europe mode	Europe mode	Not available	Europe mode	Europe mode
	TN	Europe mode	Europe mode	Europe mode	Europe mode	Norway mode
	IT	Europe mode	Europe mode	Not available	Europe mode	Norway mode
EARTH Ra	TT	Europe mode	Europe mode	Not available	Europe mode	Europe mode
	TN	Europe mode	USA mode	USA mode	USA mode	Europe mode
	IT	Europe mode	Europe mode	Not available	Europe mode	Europe mode
EARTH (measure with T2100)	TT	Europe mode	Europe mode	Not available	Europe mode	Europe mode
	TN	Europe mode	USA mode	USA mode	USA mode	Europe mode
	IT	Europe mode	Europe mode	Not available	Europe mode	Europe mode

Table 1: LOOP and EARTH measurements depending on reference countries

5.1.3. Automatic Power OFF for display and key sound



Touch the icon . The screen to the side appears on the display.

Move the slide bar reference of section "⏸" down/up to turn off/on the Automatic Power OFF of the instrument after a period of inactivity of 5 minutes.



Move the slide bar reference of section "👆" down/up to disable/enable the sound key when pressed. Confirm the choices made and go back to the previous screen.

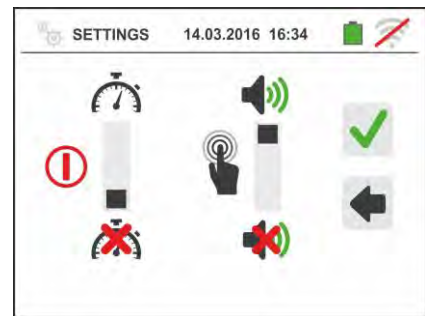

5.1.4. System



Touch the icon to select the type of electrical system (TT, TN or IT), of the mains frequency (50Hz, 60Hz), of the limit value for contact voltage (25V, 50V) and rated voltage value to be used for calculating the assumed short-circuit current. The screen to the side appears on the display.

NOTE: for "USA" country this icon is not displayed and the electrical system is fixed to TN

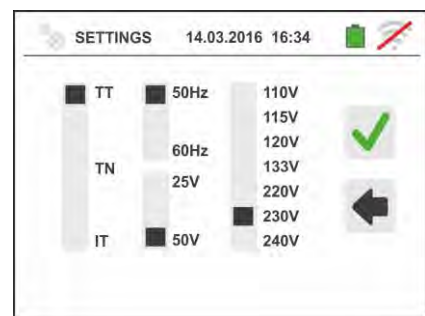

Move the slide bar references to select the options. Confirm the choices made and go back to the previous screen.

5.1.5. Operator name entry



Touch the icon  to enter the name of the operator that will be displayed in the header of each measurement downloaded to PC. The screen to the side appears on the display.

- Set the desired name using the virtual keyboard (max 12 characters).
- Confirm the settings or exit without saving.



5.1.6. System date/time setting



Touch the icon  to set the system date/time. The screen to the side appears on the display.

Touch the "EU" icon for the European date/time system in the format "DD/MM/YY hh:mm" or the "US" icon for the American system in the format "MM/DD/YY hh:mm AM/PM". Touch the up/down arrow keys to set the desired value. Confirm the settings or exit without saving.

Current date/time is kept inside the instrument without batteries for approximately 12 hours.

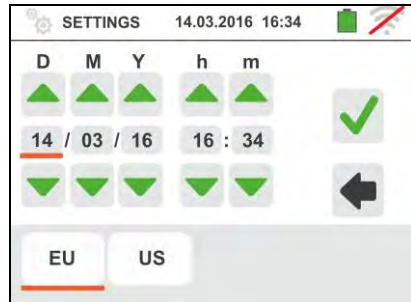

5.2. INFORMATION



Touch the icon . The display shows the screen on the right with the icons relative to the properties of the instrument, the optional accessories IMP57 and T2100 and the HTAnalysis APP



Touch the icon . The display shows the screen on the right as well as following information:

- Serial number
- Internal version of Firmware and Hardware (for the accessories IMP57 and T2100 these informations are available only after the connection to the instrument)
- Last calibration date



Touch the icon . The display shows the screen on the right with the QR code of HTAnalysis APP (see § 8.1) in iOS systems. This code permits an easy access to the Apple Store to download the APP

Touche the icon  to exit and return to the general menu



6. OPERATING INSTRUCTIONS

6.1. RPE: CONTINUITY OF PROTECTIVE CONDUCTORS

This function is performed in compliance with standards IEC/EN61557-4 and allows measuring the resistance of protective and equipotential conductors.



CAUTION

- The instrument can be used for measurements on installations with overvoltage category CAT IV 300V to earth and max 600V between inputs. Do not connect the instrument on installations with voltage exceeding the limits indicated in this manual. Exceeding these limits could cause electrical shock to the user and damage to the instrument.
- We recommend holding the alligator clip respecting the safety area created by the hand protection (see § 4.2).
- Check that no voltage is present at the ends of the item to be tested before carrying out a continuity test.
- The results may be influenced by the presence of auxiliary circuits connected in parallel with the item to be tested or by transient currents.

The following operating modes are available:

→0← Compensation of the resistance of the cables used for measurement. The instrument automatically subtracts the value of cable resistance from the measured resistance value. Therefore, it is necessary that this value is measured each time the measuring cables are changed or extended.

AUTO The instrument carries out two measurements with inverted polarity and displays their average value. Recommended mode



The instrument carries out the measurement with the possibility of setting a duration time for testing. The operator may set a sufficiently long measuring time (between 1s and 99s) to be able to move the protective conductors while the instrument is carrying out the test, in order to find out a possible bad connection.

CAUTION



Continuity test is carried out by supplying a current higher than 200mA in case the resistance does not exceed ca. 2Ω (including resistance of the test cables). For higher resistance values, the instrument carries out the test with a current lower than 200mA.

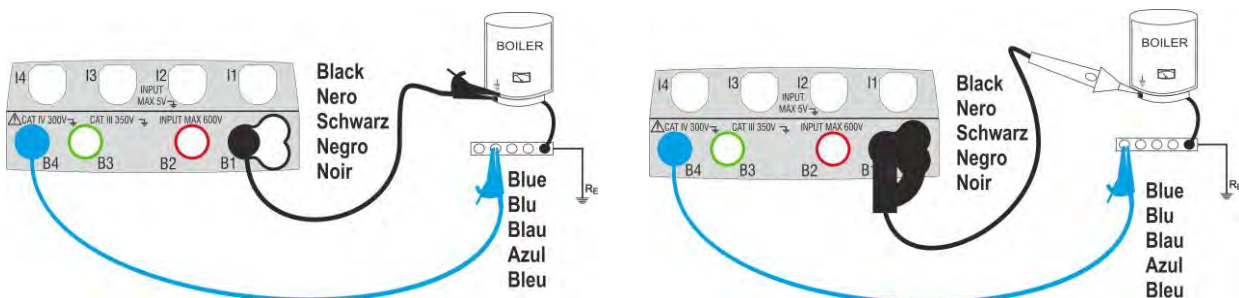

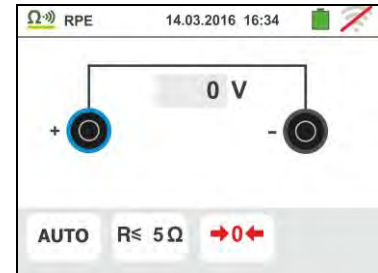



Fig. 6: Continuity test by means of single cables and remote lead

1. Touch the  icon. The screen to the side appears on the display. The instrument automatically carries out the test for the presence of voltage between the inputs (shown on the display) and blocks the test in case of voltage higher than 10V



Touch the "AUTO" icon to set the measuring mode. The following screen appears on the display:

2. Move the slide bar reference in the positions "AUTO" (Automatic mode) or "" (Timer mode). Confirm the choice by going back to the previous screen.

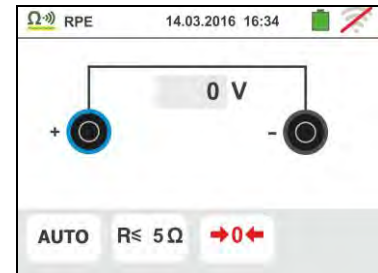

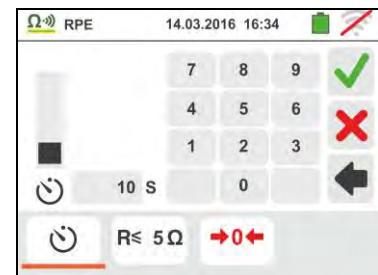

If Timer mode is selected, the following screen is shown:

3. Touch the  icon to zero the value in the Timer field and use the virtual keyboard to set the value in seconds between **1s** and **99s**. Confirm the choice by going back to the initial measurement screen.

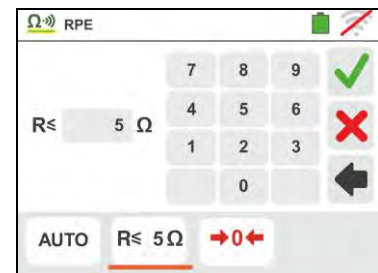

4. Touch the icon " $R \leq xx\Omega$ " to set the maximum limit value of the resistance on which the instrument makes the comparison with the measured value. The screen to the side appears on the display.



Touch the  icon to zero the value in the "R≤" field. Use the virtual keyboard to set the value between **1Ω** and **99Ω**.

Confirm the choice by going back to the initial measurement screen. Note the presence of the set limit value.

5. Perform, if necessary, the compensation of the measuring leads resistance by connecting the cables or the remote lead as shown in Fig. 7.

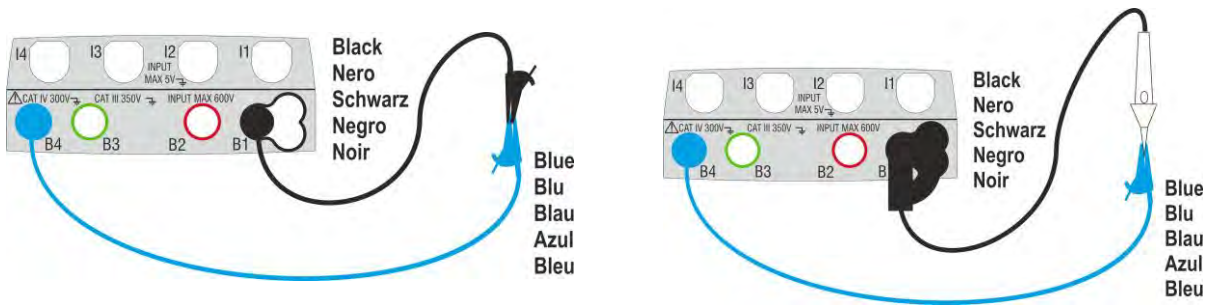

Fig. 7: Compensation of single cables and remote lead resistance

6. Touch the icon to activate the measurement. After a few seconds, the instrument provides the screen to the side if the operation is successful ($R_{\text{cables}} \leq 2\Omega$); the indication of the value is shown in the "Rcal" field and the icon is shown on the display.



Touch the "AUTO" icon or to go back to the main measurement screen.

CAUTION



Before connecting the test leads, make sure that there is no voltage at the ends of the conductor to be tested.

7. Connect the alligator clips and/or test leads and/or remote lead to the conductor to be tested as in Fig. 6.

CAUTION



Always make sure, before any measurement, that the compensation resistance value is referred to the cables currently used. In case of doubt, repeat points 5 and 6.

8. Press the **GO/STOP** key on the instrument or the **START** key on the remote lead. The instrument will start the measurement. During this whole stage, do not disconnect the test leads of the instrument from the conductor under test. The following screen appears on the display:

9. The value of the result is shown in the upper part of the screen, while the partial values of the test with inverted polarity of the test source in addition to the real test currents are reported in the fields "R+" and "R-".

The symbol indicates the positive result of the measurement.

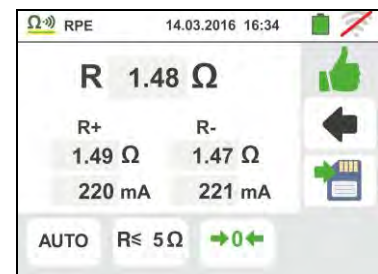

Press the **SAVE** button or touch the icon to save the measurement (see § 7.1).

10. At the end of the test, if the value of the measured resistance is higher than the set limit, the screen to the side is shown on the display.

The value is shown in red and the  symbol indicates the negative result of the measurement. The "> 99.9Ω" message indicates the instrument overload status.

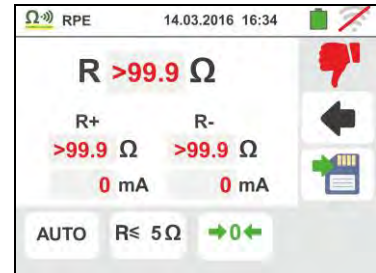



Press the **SAVE** button or touch the  icon to save the measurement (see § 7.1).

6.1.1. Anomalous situations

1. In AUTO or "🕒" modes if the instrument detects a resistance lower than the set limit value but for which it is not able to generate a current of 200mA, the screen to the side is displayed.

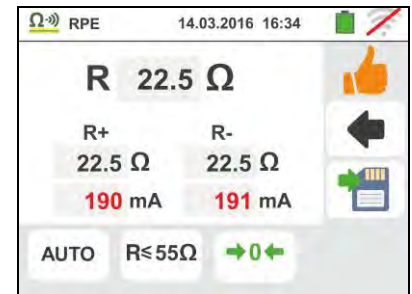
The  symbol is shown on the display and the values of the real test current are indicated in red.



2. If in  mode the instrument detects a resistance higher than 2Ω at its terminals, it resets the offset value and displays a screen like the one to the side. The  icon is shown on the display to indicate the calibration reset value (i.e. performing the operation with open terminals).



3. In case the instrument detects that the calibrated resistance is higher than the measured resistance, the instrument gives out a long sound and displays a screen like the one to the side. The  icon is shown on the display to indicate the calibration reset value.



4. If the instrument detects a voltage value higher than approx. 10V at its terminals, it does not carry out the test, gives out a long sound and the screen reported here to the side is displayed

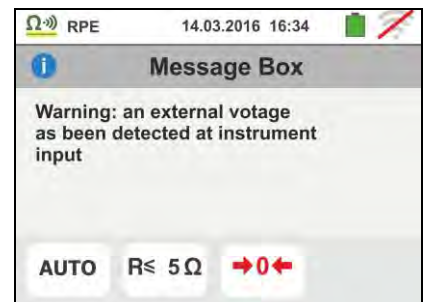

6.2. MΩ: MEASUREMENT OF INSULATION RESISTANCE

This function is performed in compliance with standards IEC/EN61557-2 and allows measuring the insulation resistance between the active conductors and between each active conductor and the earth.



CAUTION

- The instrument can be used for measurements on installations with overvoltage category CAT IV 300V to earth and max 600V between inputs. Do not connect the instrument on installations with voltage exceeding the limits indicated in this manual. Exceeding these limits could cause electrical shock to the user and damage to the instrument.
- We recommend holding the alligator clip respecting the safety area created by the hand protection (see § 4.2).
- Check that the circuit being tested is not live and that all possible loads normally connected to it are disconnected before carrying out insulation measurement.

The following operating modes are available:

AUTO The test is activated by the **GO/STOP** key of the instrument (or **START** of the remote lead). The instrument automatically detects the presence of possible capacitance and waits until test nominal voltage is reached (typically approx. 2 seconds). Recommended mode



The operator may set a sufficiently long measuring time (1s ÷ 999s) to be able to move the test lead on the conductors being tested, while the instrument is carrying out the test. For the whole measurement duration, the instrument will give out a short sound every second. While measuring, if the insulation resistance reaches a lower value than the set limit, the instrument will give a continuous acoustic signal. To stop the test, press again the **GO/STOP** key on the instrument or the **START** key on the remote lead. At the end of test, the lowest value of insulation (worst case) detected during the test will be shown by the instrument

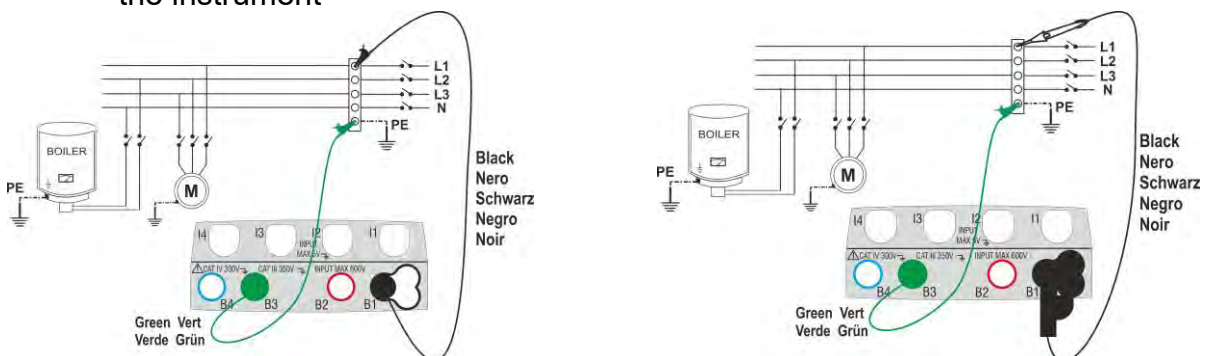

Fig. 8: Insulation test by means of single cables and remote lead

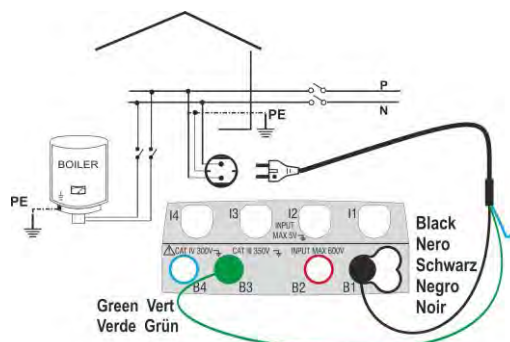

Fig. 9: Insulation test by means of shuko plug

1.



Touch the **MΩ** icon. The screen to the side appears on the display. The instrument automatically carries out the test for the presence of voltage between the inputs (shown on the display) and blocks the test in case of voltage higher than approx. 10V

Touch the "AUTO" icon to set the measuring mode. The following screen appears on the display:

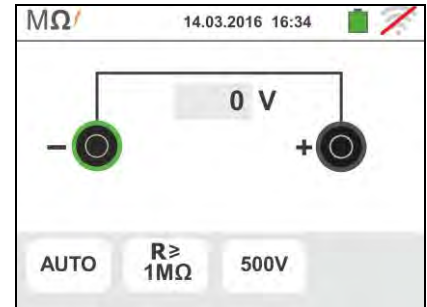

2.

Move the slide bar reference in the positions "AUTO" (Automatic mode) or "🕒" (Timer mode). Confirm the choice by going back to the previous screen.

If Timer mode is selected, the following screen is shown:



3.



Touch the **X** icon to zero the value in the Timer field and use the virtual keyboard to set the value in seconds between **1s** and **999s**. Confirm the choice by going back to the initial measurement screen.



4.

Touch the icon "R≥xxΩ" to set the minimum limit value of the insulation resistance on which the instrument makes the comparison with the measured value. The screen to the side appears on the display.



Touch the **X** icon to zero the value in the "R≥" field. Use the virtual keyboard to set the value between **0.01MΩ** and **999MΩ**.

Confirm the choice by going back to the initial measurement screen. Note the presence of the set limit value.



5.

Touch the "xxxxV" icon to set the test DC voltage in the insulation measurement. The screen to the side appears on the display.

Move the slide bar reference to the desired value for test voltage by choosing among **50, 100, 250, 500, 1000VDC**.

Confirm the choice by going back to the initial measurement screen. Note the presence of the set limit value.



CAUTION



- Disconnect any cable not strictly involved in measurement and especially check that no cable is connected to In1 input.
- Before connecting the test leads, make sure that there is no voltage at the ends of the conductors to be tested.

6. Connect the alligator clips and/or test leads and/or remote lead to the ends of the conductors to be tested as in Fig. 8 and Fig. 9.
7. Press the **GO/STOP** key on the instrument or the **START** key on the remote lead. The instrument will start the measurement.

CAUTION



During this whole stage, do not disconnect the test leads of the instrument from the conductor under test. It could remain charged with a dangerous voltage due to the stray capacitances in the circuit being tested.

8. Regardless of the operating mode selected, at the end of the measurement, the instrument applies a resistance to the output leads to discharge the capacitances in the circuit.
9. **In mode:**
 - The final result is the minimum insulation value measured during the test
 - Pressing a second time the **GO/STOP** key or the **START** key on the remote lead stops the test before the set time has elapsed.

10. The measurement result is shown both as a numeric value and in the analog bar graph as shown in the screen to the side. The values of the real test voltage and the measurement time are present on the display.

The symbol indicates the positive result of the measurement.

Press the **SAVE** button or touch the icon to save the measurement (see § 7.1).

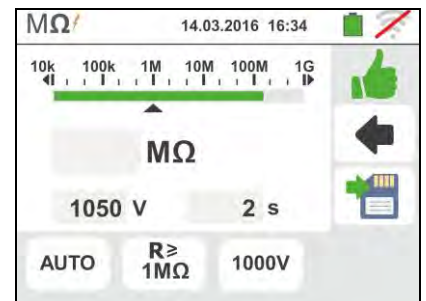

11. At the end of the test, if the value of the measured resistance is lower than the set limit, the screen to the side is shown on the display.

The value is shown in red and the symbol indicates the negative result of the measurement.

Press the **SAVE** button or touch the icon to save the measurement (see § 7.1).



6.2.1. Anomalous situations

1. If the instrument measures a resistance higher than the set limit value but for which it is not able to generate the rated voltage, the screen to the side is displayed.

The  symbol is shown on the display and the values of the real test voltage are indicated in red.

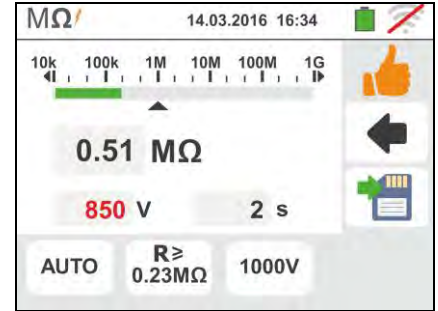

2. If the instrument detects a voltage value higher than approx. 10V at its terminals, it does not carry out the test, gives out a long sound and the screen reported here to the side is displayed.



6.3. RCD: TEST ON DIFFERENTIAL SWITCHES

This function is performed in compliance with standard IEC/EN61557-6 and allows measuring the tripping time and current of molded case differential switches of type A/F (⚡), AC (⤵) and B/B+ (⚡⚡) being General (G), Selective (S) and Delayed (⌚). The instrument allows performing tests on earth leakage relay RCDs with currents up to 10A (with optional accessory RCDX10).

CAUTION



- The instrument can be used for measurements on installations with overvoltage category CAT IV 300V to earth and max 600V between inputs. Do not connect the instrument on installations with voltage exceeding the limits indicated in this manual. Exceeding these limits could cause electrical shock to the user and damage to the instrument.
- Always connect the measuring cables to the instrument and to the alligator clips with the accessories disconnected from the system
- We recommend holding the alligator clip respecting the safety area created by the hand protection (see § 4.2).

CAUTION



Some combinations of test parameters can be not available in compliance with the technical specification of the instrument and the RCD tables (see § 11.1 – the empty cells of RCD tables means not available situations)

The following operating connections are available to perform the RCD test:

CAUTION



Testing the RCD tripping time causes its tripping. **Therefore, check that there are NO users or loads connected downstream of the differential switch being tested which could be damaged by a system downtime.** Disconnect all loads connected downstream of the differential switch as they could produce leakage currents further to those produced by the instrument, thus invalidating the results of the test.

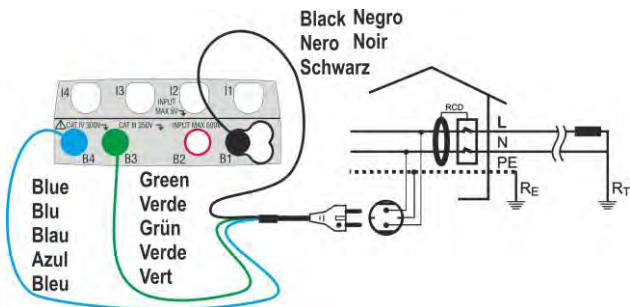

Fig. 10: Connection for single-phase system by means of shuko plug

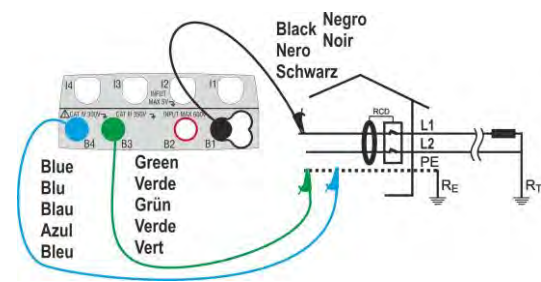

Fig. 11: Connection for split-phase no neutral (no RCD B/B+ type)

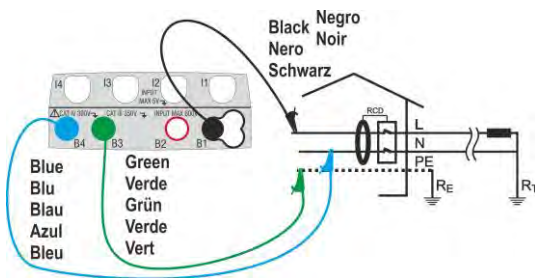

Fig. 12: Connection for single-phase system with single cables and remote lead

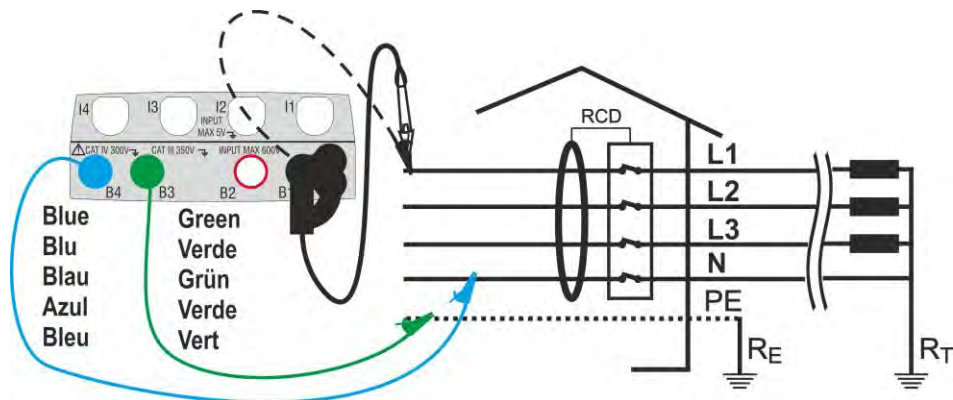

Fig. 13: Connection for a three phase 4-wire by means of single cables and remote lead

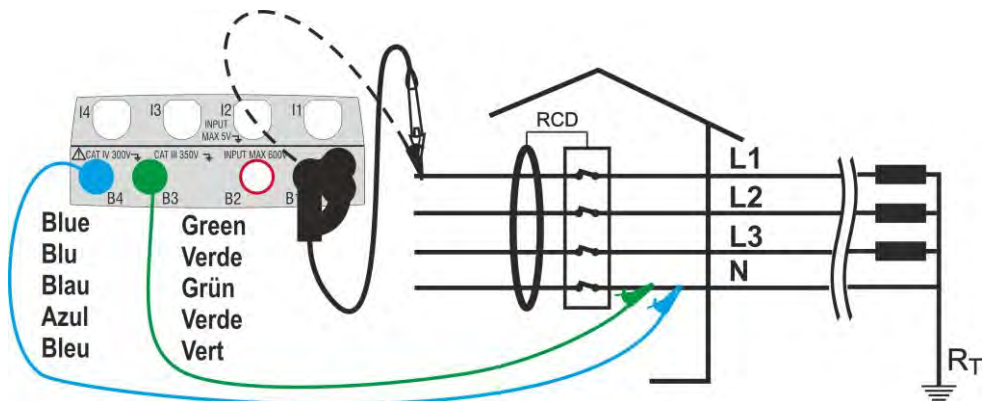

Fig. 14: Connection three phase 4-wire (no PE), single cables, remote lead (no RCD B/B+ type)

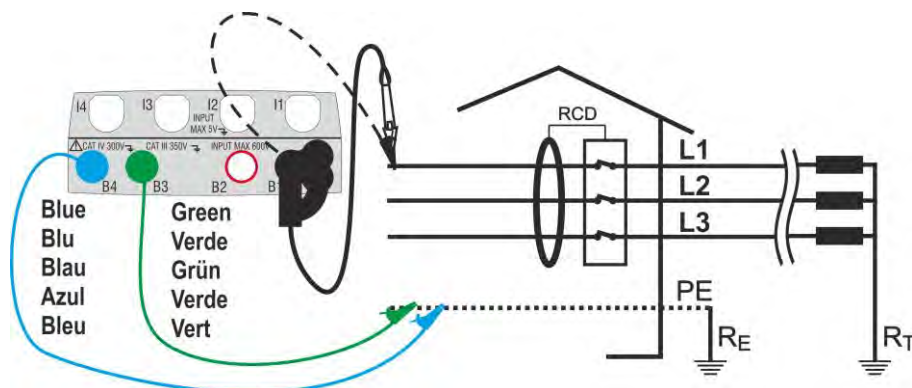

Fig. 15: Connection for a three phase 3-wire (no N) single cables, remote lead (no RCD B type)

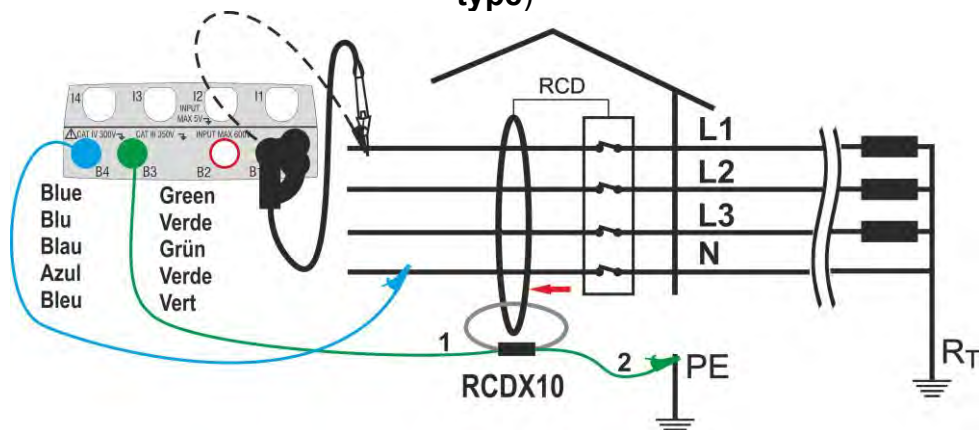
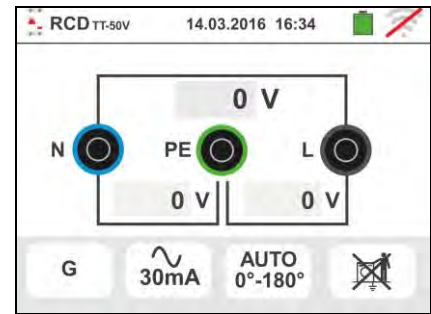
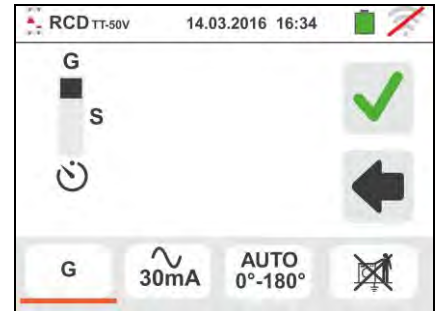

Fig. 16: Connection to earth leakage relay RCDs with optional accessory RCDX10

1. Select the options “TN, TT or “IT”, “25 or 50V”, “50Hz or 60Hz” and the reference voltage in the general settings of the instrument (see § 5.1.4). Touch the icon. The screen to the side appears on the display. Touch the icon to the left to set the RCD operating mode. The following screen appears on the display:



2. Move the slide bar reference by selecting the desired operating mode between the options: **G** (General), **S** (Selective), (Delayed). Confirm the choice by going back to the initial measurement screen. Note the presence of the chosen selection. When selecting a Delayed RCD, the instrument displays the following screen.



3. Touch the icon to zero the value in the Timer field and use the virtual keyboard to set the value of RCD delay time in seconds between **1ms** and **500ms**. Confirm the choice by going back to the initial measurement screen. Touch the second icon to set the type of RCD, the waveform and the tripping current. The following screen appears on the display.

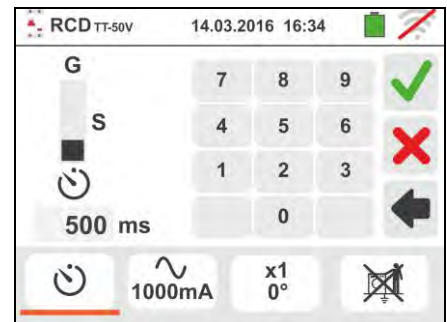

4. Move the left slide bar reference and select the type of RCD between the following options: **STD** (molded case RCD) and (earth leakage delay RCD with use of optional accessory RCDX10). In case of earth leakage relay RCD the following screen appears on the display

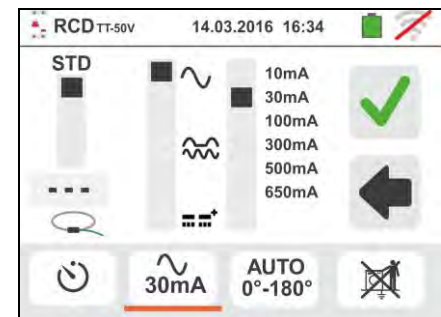

5. Touch the icon to zero the value in “A” field and use the virtual keyboard to set the value of rated current of earth leakage relay RCD. The maximum rated current is **10.0A**. Confirm the choice by going back to the previous screen. Move the second slide bar reference by selecting the waveform of the differential switch between the options: A/F () , AC () and B/B+ () For RCD of **molded case type STD** move the third slide bar reference by selecting the desired rated current of the differential switch between the options: **10, 30, 100, 300, 500, 650, 1000mA** Confirm the choice by going back to the initial measurement screen. Note the presence of the chosen selections



6. Touch the third icon at the bottom of display and select the desired type of test among the options::

- **x 1/2** → Manual with multiplier 1/2 I_{dn}
- **x 1** → Manual with multiplier 1I_{dn}
- **x 2** → Manual with multiplier 2I_{dn}
- **x 5** → Manual with multiplier 5I_{dn}
- **AUTO** → Auto mode (6 tests in sequence)
-  → Ramp (real tripping current measurement)



Move the right slide bar reference by selecting the polarity of the test current between the options: **0°** (direct polarity), **180°** (inverted polarity), **0°-180°** (for Automatic mode only). Move the lower right slide bar reference by selecting (for Ramp mode only) the kind of the trip out current visualization between the followed options:

- **NOM** → the instrument shows the normalized value of trip out current (referred to the nominal current). **Example:** for RCD type A/F with I_{dn}=**30mA** the effective value of normalized trip out current can be up to **30mA**
- **REAL** → the instrument shows the effective value of the trip out current by considering the coefficients indicated by the IEC/EN61008 and IEC/EN61009 guidelines (1.414 for RCD type A/F, 1 for RCD type AC, 2 for RCD type B/B+). **Example:** for RCD type A/F with I_{dn}=**30mA** the effective value of trip out current can be up to **30mA * 1.414 = 42mA**

NOTE: The selection of the two option involves only the choose of the trip out current visualization but not influence the outcome test (OK/NO)

Confirm the choice by going back to the initial measurement screen

7. Touch the fourth icon at the bottom of the display and select the possible visualization of the contact voltage value at the end of measurement. The following options are possible:

-  → The value of contact voltage is shown on the display at the end of measurement (the test time will be slightly longer)
-  → The value of contact voltage is not shown on the display at the end of measurement. The symbol “- - -” is shown

8. Insert the green, blue and black connectors of the three-pin shuko plug into the relevant instrument input terminals B3, B4, B1. As an alternative, use the single cables and apply the relevant alligator clips to the free ends of the cables. It is also possible to use the remote lead by inserting its multipolar connector into the input lead B1. Connect the shuko plug, the alligator clips or the remote lead to the electrical mains according to Fig. 10, Fig. 12, Fig. 13, Fig. 14 and Fig. 15.

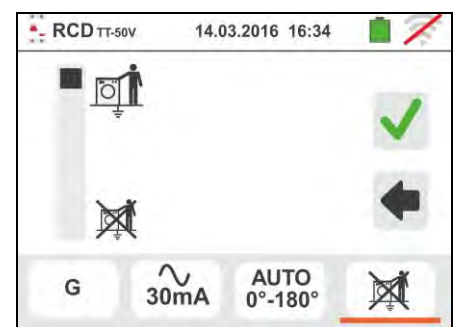
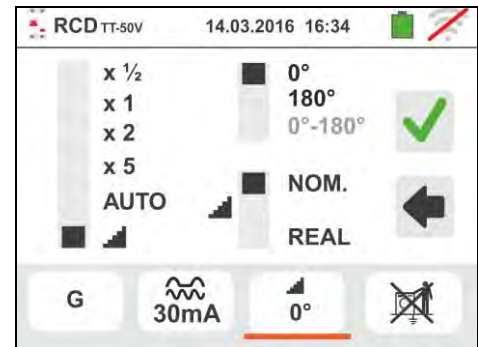

6.3.1. AUTO mode

9. Press the **GO/STOP** key for 2s on the instrument or the **START** key on the remote lead. The instrument will start the measurement.

The screen to the side is shown on the display when the icon indicates the performance of the test.

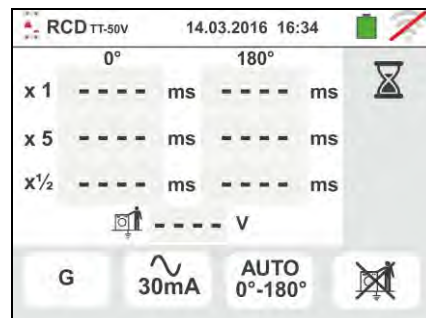

- 10 The AUTO mode foresees the automatic execution of 6 measurements in a sequence:

- IdN x 1 with phase 0° (the RCD must trip, reset the switch, icon)
- IdN x 1 with phase 180° (the RCD must trip, reset the switch, icon)
- IdN x 5 with phase 0° (the RCD must trip, reset the switch, icon)
- IdN x 5 with phase 180° (the RCD must trip, reset the switch, icon)
- IdN x 1/2 with phase 0° (RCD must not trip)
- IdN x 1/2 with phase 180° (RCD must not trip, end of test)

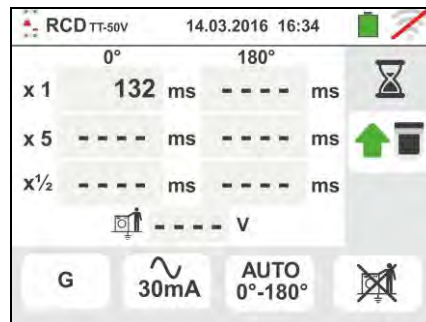

- 11 The test has a positive result if all tripping times of **molded case type STD** comply with what indicated in Table 4 (see § 13.4). The test has a negative result when one of the values is out of range. During this whole stage, do not disconnect the measuring leads of the instrument from the system on test.

- 12 At the end of the test, if the tripping time of each test complies with what is indicated in Table 4 (see § 13.4)

the instrument shows the symbol to signal that the test has been completed successfully, and displays a screen similar to the one reported here to the side.

Press the **SAVE** button or touch the icon to save the measurement (see § 7.1).

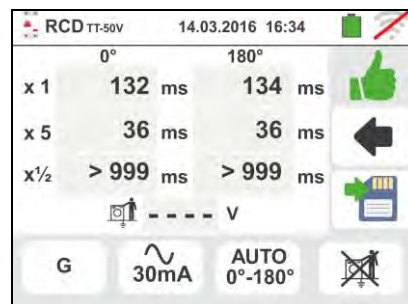

- 13 At the end of the test, if the tripping time of a test does not comply with what is indicated in Table 4 (see § 13.4). the instrument shows the symbol to signal that the test has not been completed successfully, and displays a screen similar to the one reported here to the side.

Press the **SAVE** button or touch the icon to save the measurement (see § 7.1).

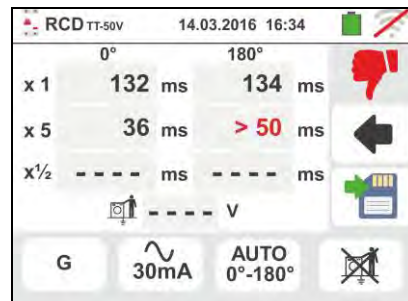

CAUTION

According to standard EN61008, the test for Selective differential switches requires an interval of 60 seconds between the tests (30s for tests with 1/2 Idn). The instrument display shows a timer indicating the time remaining before the instrument can automatically perform the test.

6.3.2. $x\frac{1}{2}$, $x1$, $x2$, $x5$ modes

9. Press the **GO/STOP** key for 2s on the instrument or the **START** key on the remote lead. The instrument will start the measurement.

The screen to the side (concerning multiplier $x1$) is shown on the display when the icon indicates the performance of the test.

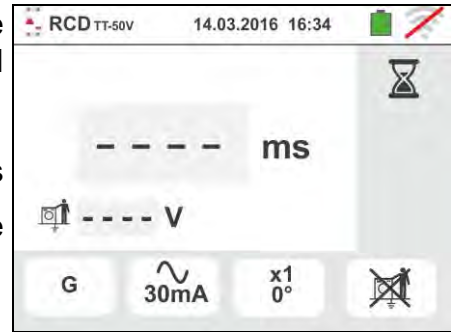

- 10 At the end of the test with multiplier $x1/2$, $x1$, $x2$ or $x5$ if the tripping time, for **molded case type STD**, is as listed in Table 4

the instrument shows the symbol to signal that the test has been completed successfully, and displays a screen similar to the one reported here to the side.

Press the **SAVE** button or touch the icon to save the measurement (see § 7.1).

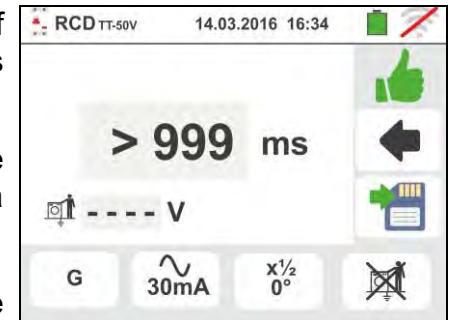

- 11 At the end of the test, for **molded case type STD**, if the tripping time of a test does not comply with what is indicated in Table 4 the instrument shows the symbol to signal that the test has not been completed successfully, and displays a screen similar to the one reported here to the side.

Press the **SAVE** button or touch the icon to save the measurement (see § 7.1).

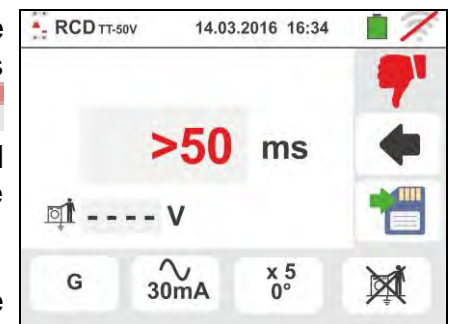

6.3.3. Mode $x1$ – Test on RCDs with delay time

9. At the end of the test, if the measured tripping time is within the interval: [**limit delay = set delay time + value indicated in Table 4**] the instrument displays the symbol to indicate the positive outcome of the test and displays a screen like the one to the side.

Press the **SAVE** button or touch the icon to save the measurement (see § 7.1).

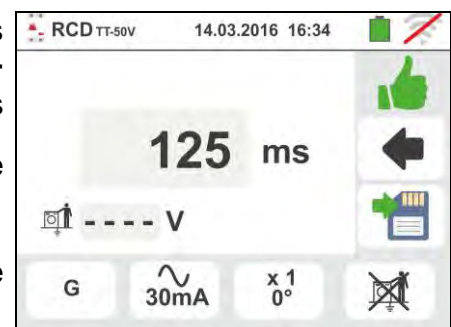

- 10 At the end of the test, if the measured tripping time is external the interval: [**limit delay = set delay time + value indicated in Table 4**] the instrument displays the symbol to indicate the negative outcome of the test and displays a screen like the one to the side.

Press the **SAVE** button or touch the icon to save the measurement (see § 7.1).

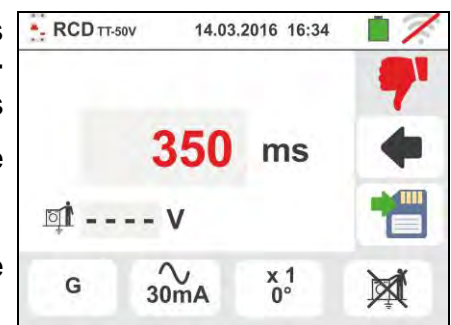

6.3.4. Mode

The standard defines, for **molded case type STD**, the tripping times for RCDs at nominal current. The mode is used to detect the minimum tripping current (which could also be lower than the nominal voltage).

9. Press the **GO/STOP** key for 2s on the instrument or the **START** key on the remote lead. The instrument will start the measurement.

The screen to the side is shown on the display when the hourglass icon indicates the performance of the test.

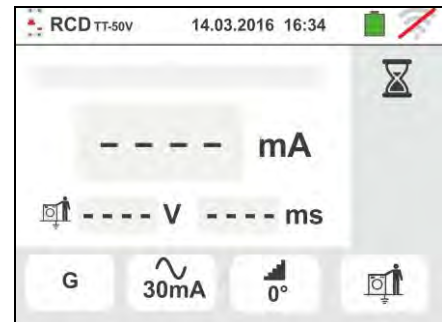

- 10 At the end of the test, if the tripping current is within the values of the table in the relevant §, the instrument displays the symbol to indicate the positive outcome of the test and displays a screen like the one to the side.

Press the **SAVE** button or touch the icon to save the measurement (see § 7.1).

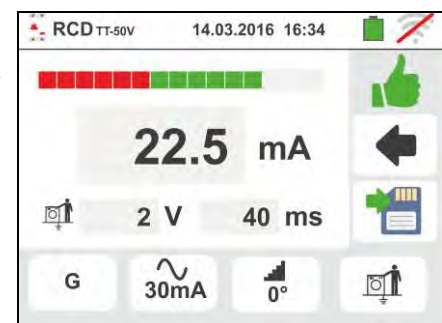

- 11 At the end of the test, if the tripping current is not within the values of the table in the relevant §, the instrument displays the symbol to indicate the negative outcome of the test and displays a screen like the one to the side.

Press the **SAVE** button or touch the icon to save the measurement (see § 7.1).

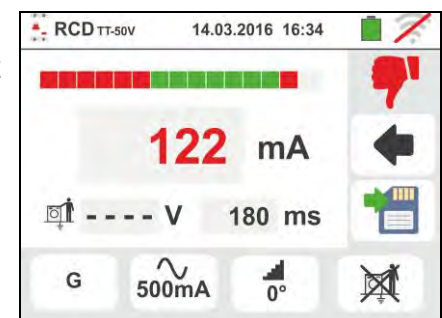

- 12 **For RCD type A/F and B/B+** it is possible to have a positive outcome also if the result is higher than the selected nominal current. This is due to the “REAL” option visualization selected (see § 6.3 – point 6)

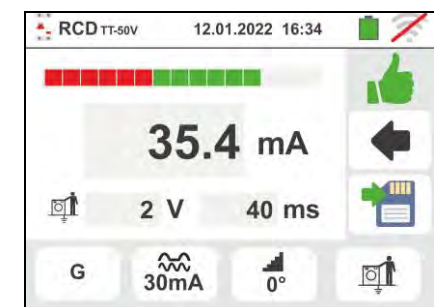

6.3.5. Test on earth leakage relay RCD

The instrument allows performing tests on earth leakage relay RCD with currents up to 10A (with optional accessory RCDX10)

8. Connect the instrument and the optional accessory **RCDX10** to the installation (see Fig. 16). Pay attention to the connection of cables “1” and “2” of the RCDX10 accessory and to the direction of the current indicated by the arrow printed on the accessory. It is also possible to use the remote lead by inserting its multipolar connector into input lead B1

9. Press the **GO/STOP** key for 2s on the instrument or the **START** key on the remote lead. The instrument will start the measurement.

The screen to the side is shown on the display when the hourglass icon indicates the performance of the test.

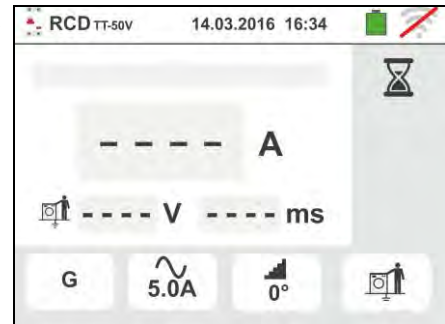

- 10 At the end of the test, if the tripping current is lower to the set value, the instrument displays the  symbol to indicate the positive outcome of the test and displays a screen like the one to the side.

Press the **SAVE** button or touch the  icon to save the measurement (see § 7.1)

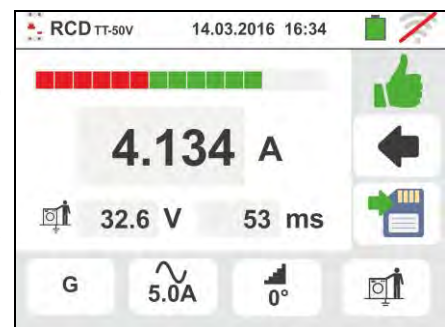

- 11 At the end of the test, if the tripping current is higher to the set value, the instrument displays the  symbol to indicate the negative outcome of the test and displays a screen like the one to the side.

Press the **SAVE** button or touch the  icon to save the measurement (see § 7.1)

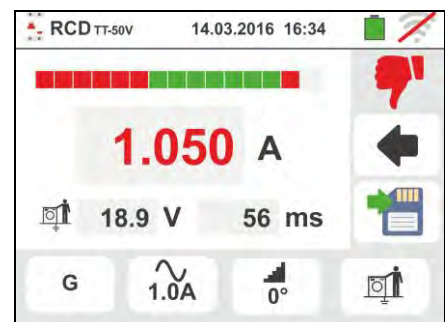

6.3.6. Anomalous situations

1. If the voltage between inputs B1 and B4 and inputs B1 and B3 is higher than 265V, the instrument provides the warning screen shown to the side and blocks the execution of the tests.

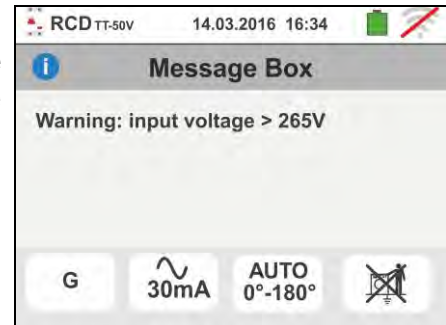

2. If the voltage between inputs B1 and B4 and inputs B1 and B3 is lower than 100V, the instrument provides the warning screen shown to the side and blocks the execution of the tests.

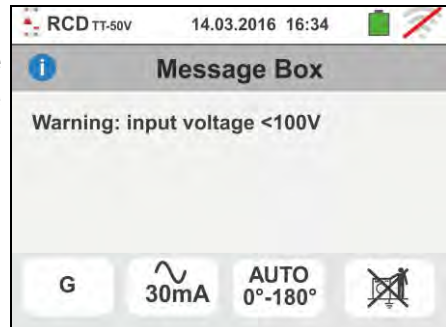

3. If the instrument detects the absence of the signal to terminal B1 (phase conductor), it provides the warning screen shown to the side and blocks the execution of the tests.

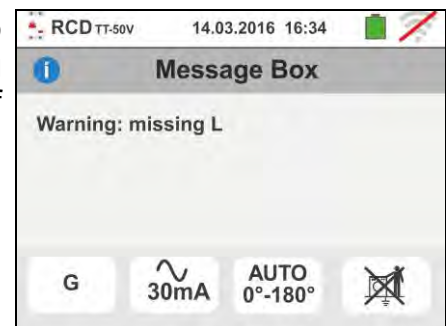

4. If the instrument detects the absence of the signal to terminal B4 (neutral conductor), it provides the warning screen shown to the side and blocks the execution of the tests.

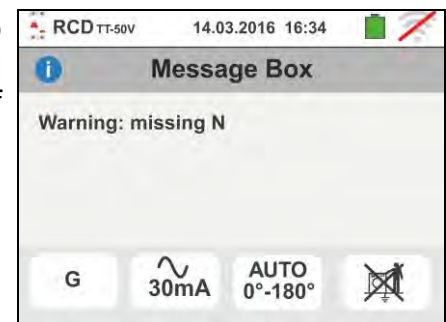

5. If the instrument detects the absence of the signal to terminal B3 (PE conductor), it provides the warning screen shown to the side and blocks the execution of the tests.

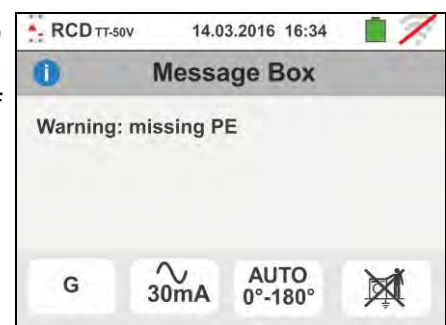

6. If the instrument detects that the phase and neutral leads are inverted, it does not carry out the test and a screen similar to the one reported to the side is displayed. Rotate the shuko plug or check the connection of measuring cables.

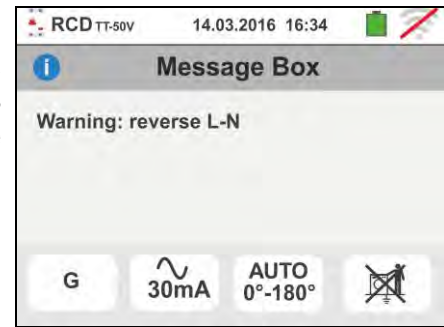

7. If the instrument detects that the phase and PE leads are inverted, it does not carry out the test and a screen similar to the one reported to the side is displayed. Check the connection of measuring cables.



8. If the differential switch being tested trips during the preliminary checks (performed automatically by the instrument before executing the selected test), the instrument does not carry out the test and displays a screen like the one to the side. Check that the IdN set value is consistent with the differential switch in question and that all loads connected downstream of it are disconnected.

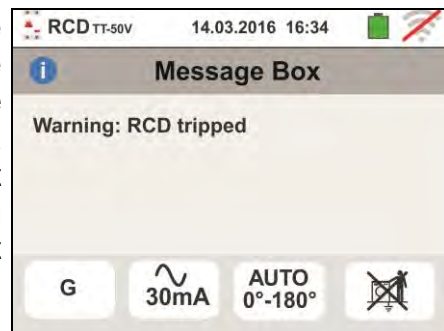

9. If the instrument detects a dangerous voltage on PE conductor it provides the warning screen shown to the side and blocks the execution of the tests. Check the PE conductor and earth plant efficiency. This message can also appear in case of an insufficient pressure of the **GO/STOP** key

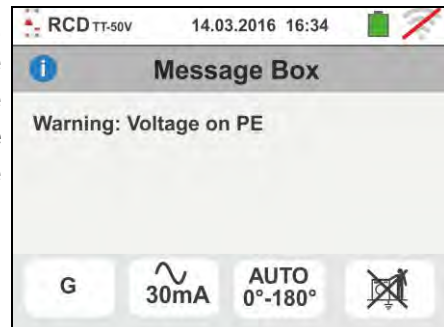

- 10 If the instrument detects a dangerous contact voltage U_t (over the set limit 25V or 50V) in the starting pre-test, it provides the warning screen shown to the side and blocks the execution of the tests. Check the PE conductor and earth plant efficiency



- 11 If the instrument detects a voltage $V_{n-pe} > 50V$ (or the analogue $V_{n-pe} > 25V$) it provides the warning screen shown to the side and blocks the test for safety reasons. Check the PE conductor and earth plant efficiency



- 12 If the instrument detects in the input terminals a too high external impedance such that it can not provides the nominal current, it provides the warning screen shown to the side and blocks the test. Disconnect the possible loads downstream the LCD before perform the test



- 13 **For only RCD type B/B+** if the instrument is not able to provide for the charging of the internal capacitors of the RCD, it provides the warning screen shown to the side and blocks the test. Check that the VL-N voltage should be more than 190V



- 14 **For only RCD type B/B+** if the instrument detects a input voltage $V_{L-N} < 190V$, it provides the warning screen shown to the side and blocks the test. Check the values of the voltages on the installation

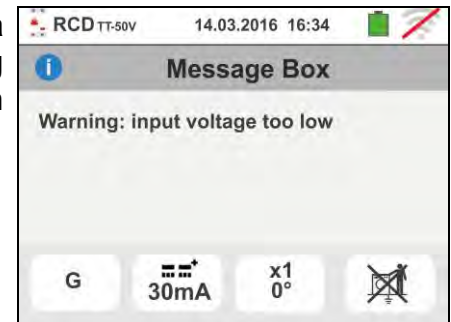

- 15 **For test on earth leakage relay RCD** if the value set for the rated current of the protection device is out of the allowed range, the instrument provides the warning screen shown to the side and stops the tests. Change the value of the rated current of the protection device

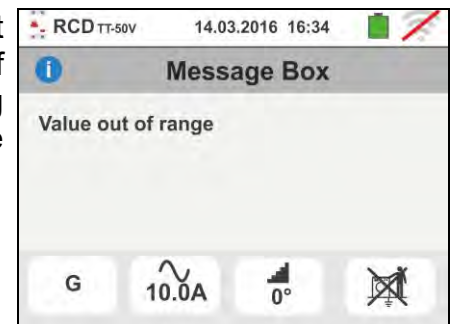

6.4. LOOP: LINE IMPEDANCE/LOOP AND OVERALL EARTH RESISTANCE

This function is performed in compliance with standard IEC/EN61557-3 and allows measuring the line impedance, the fault loop impedance and the prospective short-circuit current.



CAUTION

- The instrument can be used for measurements on installations with overvoltage category CAT IV 300V to earth and max 600V between inputs. Do not connect the instrument on installations with voltage exceeding the limits indicated in this manual. Exceeding these limits could cause electrical shock to the user and damage to the instrument.
- Always connect the measuring cables to the instrument and to the alligator clips with the accessories disconnected from the system
- We recommend holding the alligator clip respecting the safety area created by the hand protection (see § 4.2).



CAUTION

Depending on the selected electrical system (TT, TN or IT) some kind of connection and function modes are disabled by the instruments (see Table 2)

The following operating modes are available

- L-N** Standard (STD) measurement of the line impedance between the phase conductor and the neutral conductor and calculation of the assumed phase-to-neutral short-circuit current. This measurement is carried out even with high resolution (0.1mΩ) through the optional accessory IMP57.
- L-L** Standard (STD) measurement of the line impedance between the two phase conductors and calculation of the assumed phase-to-phase short-circuit current. This measurement is carried out even with high resolution (0.1mΩ) through the optional accessory IMP57.
- L-PE** Standard (STD) measurement of the fault loop impedance between the phase conductor and the earth conductor and calculation of the assumed phase-to-earth short-circuit current. This measurement is carried out even with high resolution (0.1mΩ) through the optional accessory IMP57.
- Ra_±** Global earth resistance without causing the differential protections tripping in systems with and without neutral (see § 13.11)



CAUTION

The measurement of line impedance or fault loop impedance involves the circulation of a maximum current according to the technical specifications of the instrument (see § 11.1). This could cause the tripping of possible magnetothermal or differential protections at lower tripping currents.

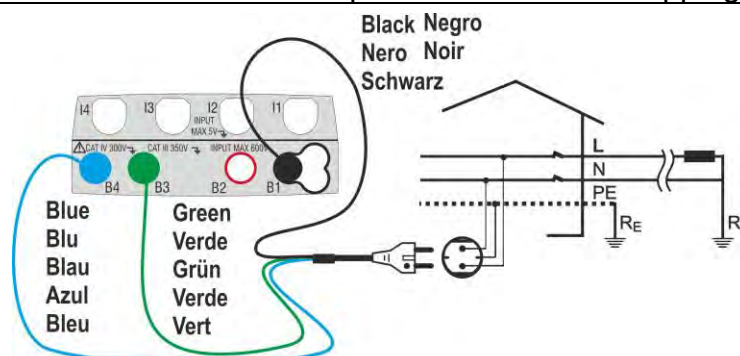

Fig. 17: L-N/L-PE measure for single-phase systems with shuko plug

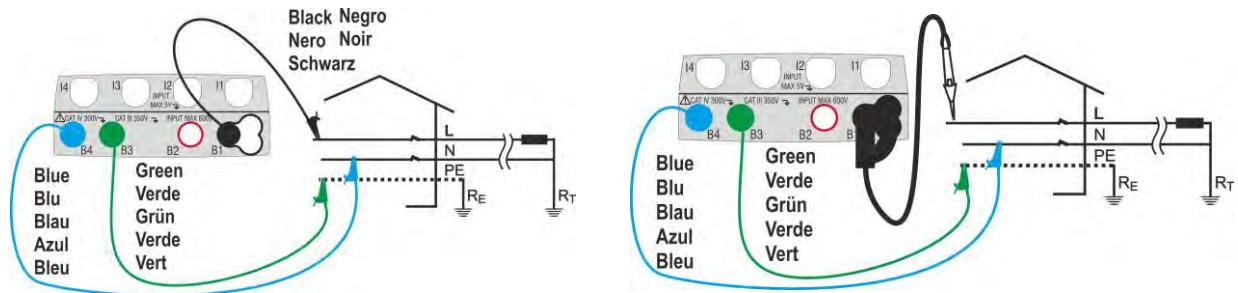

Fig. 18: L-N/L-PE measure for single-phase/two-phase with cables and remote lead

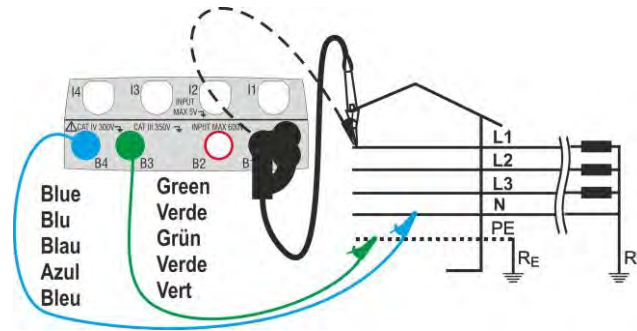

Fig. 19: L-N/L-PE test for three-phase systems by means of single cables and remote lead

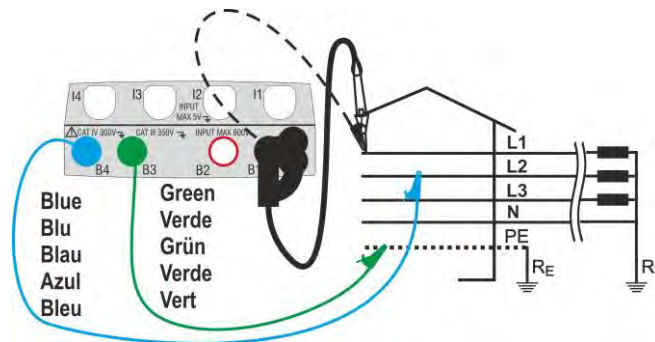

Fig. 20: L-L test for three-phase systems by means of single cables and remote lead

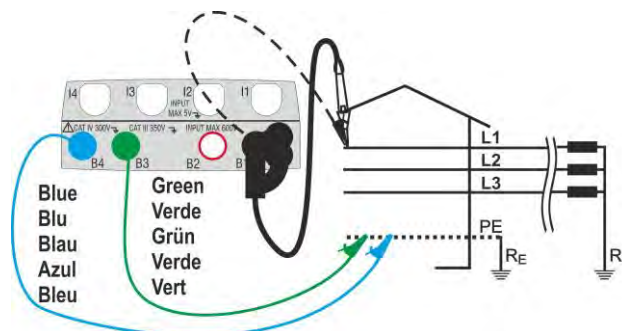

Fig. 21: L-PE/L-N test for three-phase systems (no N) by means of single cables and remote lead

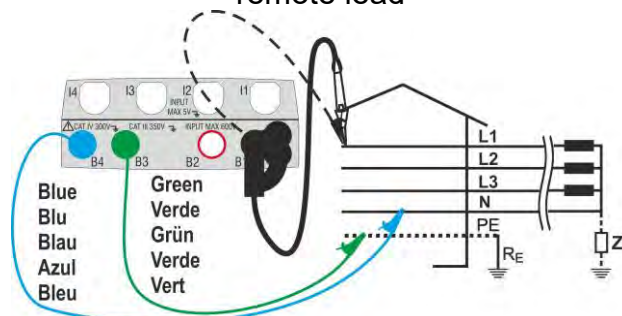

Fig. 22: L-PE measurement for IT systems by means of single cables and remote lead

6.4.1. Test types

The protection of electrical lines is the essential part of a project so as to guarantee the correct functionality and avoid damages to persons or property. To this purpose, the safety guidelines impose on electrical designers also to design the electrical installation in order to reach:

1. The protection from short-circuits, that's to say:
 - The breaking capacity of the protection device must be not lower than the supposed short-circuit current in the point in which the device is installed
 - In case of short-circuit in any point of the protected line, the protection device must trip on quickly enough to avoid that the insulation materials assume excessive temperatures
2. The protection from indirect contacts.

In order to verify the a.m. conditions, the instrument performs the following functions:



Check of protection from indirect contact – According to the type of distribution system (TT, TN, IT) set by the user, the instrument performs the measurement and verifies the condition imposed by the guidelines. Should it be reached, the instrument gives a positive outcome (see § 13.6, § 13.7, §13.8)

kA **Check of protection's breaking capacity** – The instrument detects the value of the line impedance upstream to the measurement point, calculates the maximum value of short-circuit current and gives a positive outcome if the value is lower than the limit set by the user (see § 13.5)

I²t **Check of protection from short-circuits** – The instrument detects the value of the line impedance upstream to the measurement point, calculates the value of short-circuit current and the corresponding value of the trip out time (t) of the protection device and gives a positive outcome if the value of specific energy passing through the protection device is lower than the specific short-circuit energy bearable by the cables according to the known relationship (see § 13.10):

$$(K * S)^2 \geq I^2 t$$

where K and S are parameters of the cable, set by the user, that's to say:

K= parameter indicated by the guideline depending on the type of conductor material and on the material of the insulating sheath

S = section of the cable

To completion of the above checks, the instrument performs also:



Check of the coordination of protections – The instrument detects the value of the line impedance upstream to the measurement point, calculates the minimum value of short-circuit current and the corresponding value of the trip out time (t) of the protection device and gives a positive outcome if the value is lower than the limit set by the user (see § 13.9)

STD Generic test

The IMP57 optional accessory allows the instrument to perform both individual and high resolution (0.1mΩ) Line/Loop impedance measurements

The following table summarizes the possible measures executable depending on the type of system (TT, TN and IT), of selected modes and the relationships that define limit values









Mode	TT	TN	IT
	Condition x OK outcome	Condition x OK outcome	Condition x OK outcome
L-L	STD	No outcome	No outcome
	kA	Isc L-L max < BC	Isc L-L max < BC
	I ² t	(Isc L-L 3F) ² * t < (K * S) ²	(Isc L-L3F) ² * t < (K * S) ²
		(IscL-Lmin 2F) → Tmax → Tmax < Tlim	(IscL-L min 2F) → Tmax → Tmax < Tlim
			
L-N	STD	No outcome	No outcome
	kA	Isc L-N max < BC	Isc L-N max < BC
	I ² t	(Isc L-N) ² * t < (K * S) ²	(Isc L-N) ² * t < (K * S) ²
		(Isc L-N min) → Tmax → Tmax < Tlim	(Isc L-N min) → Tmax → Tmax < Tlim
			
L-PE	STD	No outcome	
	kA	Isc L-PE max < BC	
	I ² t	(Isc L-PE) ² * t < (K * S) ²	
		(Isc L-PE min) → Tmax → Tmax < Tlim	
		Tlim → Ia → Isc L-PE MIN > Ia	Utmeas < Utlim
Ra (No for IMP57)	STD		
	kA		
	I ² t		
			
		(Rameas * Idn) < Utlim	Isc L-PE MIN > Idn

Table 2: Conditions of positive outcome depending on the test parameters

Where:

Empty cells	Not available mode for this particular combination of electric system
Isc L-L 3F	Prospective short circuit current three-phase Phase-Phase (see § 13.5)
Isc L-L_Min2F	Prospective short circuit current minimum two-phase Phase-Phase (see § 13.9)
Isc L-N_Max	Prospective short circuit current maximum Phase-Neutral (see § 13.5)
Isc L-N_Min	Prospective short circuit current minimum Phase-Neutral (see § 13.9)
Isc L-PE_Max	Prospective short circuit current maximum Phase-PE (see § 13.5)
Isc L-PE_Min	Prospective short circuit current minimum Phase-PE (see § 13.9)
BC	Breaking Capacity of the protection device - kA)
K	Constant relative to the I ² t measurement (vedere § 13.10)
S	Section of conductor
Tmax	Maximum trip out time of the protection device
Tlim	Limit time of fault extinction by the protection set by the user
Ut meas	Contact voltage measured
Ut lim	Contact voltage limit (25V or 50V)
Ra meas	Global earth resistance measured
Idn	Trip out current of RCD devices

6.4.2. STD Mode – Generic test

This mode performs the impedance measurement and the calculation of prospective short circuit current without applying any evaluation. Therefore, at the end of the test, no outcome is given by the instrument.

1. Select the options “TN, TT or “IT”, “25 or 50V”, “50Hz or 60Hz” and the reference voltage in the general settings of the instrument (see § 5.1.4).

Touch the icon. The screen to the side appears on the display.

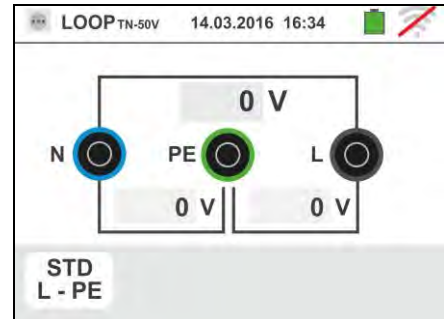

Touch the lower icon. The following screen appears on the display:

2. Move the left slide bar reference by selecting the icon to execute the measurement only with the instrument or the icon to execute the measurement with the instrument + optional accessory IMP57 (see § 6.4.10).

Move the central slide bar reference by selecting the “**L-L**, **L-N** or **L-PE**” options. Move the right slide bar reference by selecting the “**STD**” option. Confirm the choice by going back to the previous screen.

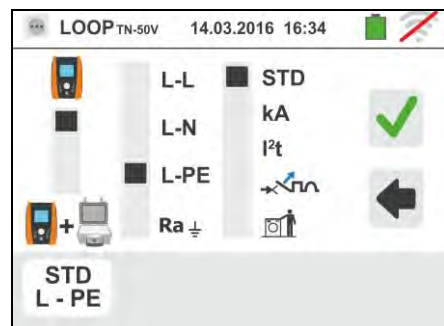

3. If possible, disconnect all loads connected downstream of the measuring point, as the impedance of these users could distort the test results.
4. Connect the shuko plug, the alligator clips or the remote lead to the electrical mains according to Fig. 17, Fig. 18, Fig. 19 and Fig. 21.

5. Note the presence of the correct voltage values between L-N and L-PE corresponding to the selections carried out in the initial phase (see § 5.1.4) as shown in the screen to the side.

Press the **GO/STOP** key for 2s or the **START** key on the remote lead. During this whole stage, do not disconnect the measuring leads of the instrument from the system under test. The following screen appears on the instrument's display:

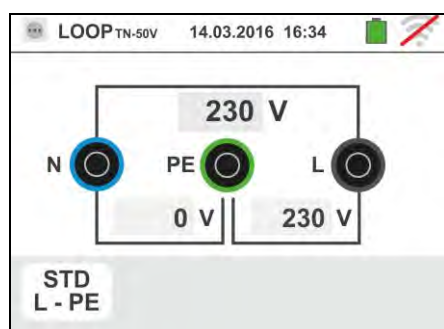

6. The value of the assumed short-circuit current (I_{sc}) is shown in the upper part of the display, while the Line/Loop Z_{PE} impedance is shown at the bottom of the display.

Press the **SAVE** button or touch the  icon to save the measurement (see § 7.1).

The Standard (Std) assumed short-circuit current (I_{sc}) is calculated using the following formula:

$$I_{SC} = \frac{U_{NOM}}{Z_{MEAS}}$$

Z_{MEAS} = measured L-L,L-N,L-PE loop impedance

U_{NOM} = nominal voltage (depend on the system)





6.4.3. Mode kA – Verify of breaking capacity of protection device

1. Select the options “TN, TT or “IT”, “25 or 50V”, “50Hz or 60Hz” and the reference voltage in the general settings of the instrument (see § 5.1.4).

Touch the  icon. The screen to the side appears on the display.

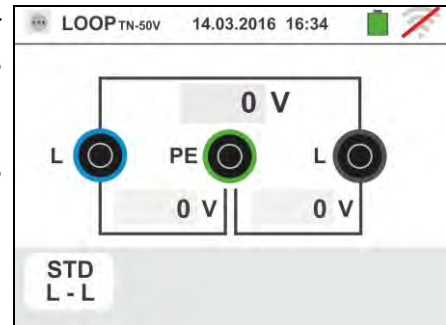
Touch the lower icon. The following screen appears on the display:



2. Move the left slide bar reference by selecting the  icon to execute the measurement only with the instrument or the  icon to execute the measurement with the instrument + optional accessory IMP57 (see § 6.4.10).

Move the central slide bar reference by selecting the “L-L”, “L-N” or “L-PE” options (for TN systems only).

Move the right slide bar reference by selecting the “kA” option.

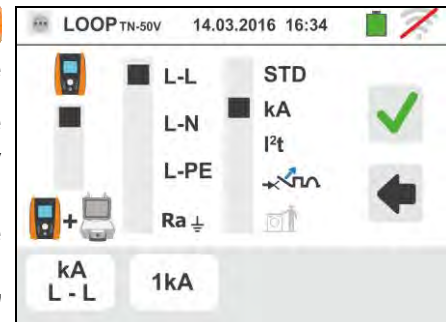

Touch the icon in the lower right corner to set the maximum tripping current expressed in “kA” that the protection must interrupt. The following screen appears on the display:

3. Touch the  icon to zero the value in the kA field and use the virtual keyboard to set the value of the breaking capacity of the protection between **1kA** and **9999kA**

Confirm the choice by going back to the initial measurement screen.



4. If possible, disconnect all loads connected downstream of the measured point, as the impedance of these users could distort the test results. Connect the shuko plug, the alligator clips or the remote lead to the electrical mains according to Fig. 17, Fig. 18, Fig. 19 and Fig. 21 in the nearest possible point to the protection device
Note the presence of the correct voltage values between L-L and L-PE corresponding to the selections carried out in the initial phase (see § 5.1.4) as shown in the screen to the side.

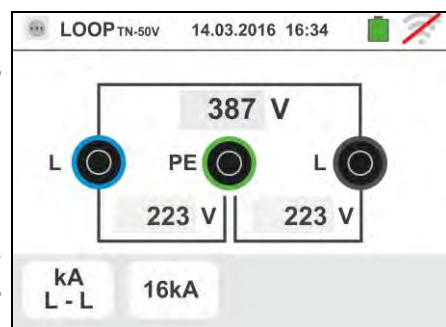

5. Press the **GO/STOP** key for 2s or the **START** key on the remote lead. During this whole stage, do not disconnect the measuring leads of the instrument from the system under test.

In case of positive outcome, the screen to the side is shown by the instrument.

Press the **SAVE** button or touch the  icon to save the measurement (see § 7.1).

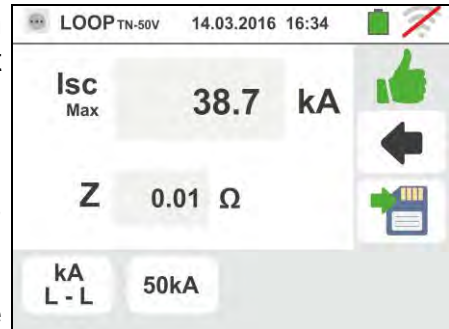

6. In case of test failure (measured Isc Max current > set threshold), the screen to the side is displayed by the instrument.

Note the presence of the measurement result highlighted in red.

Press the **SAVE** button or touch the  icon to save the measurement (see § 7.1).

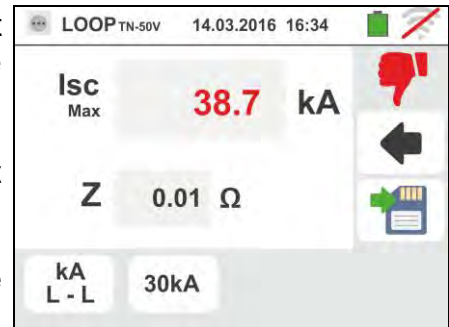

6.4.4. Mode I^2t – Verify of protection against short-circuit

CAUTION



The verify of conductor protection against the thermic effect of short-circuit is performed under the following conditions:

- Ambient temperature of 25°C
- Presence of external insulation (not live conductor)
- No harmonics
- Short-circuit at the beginning of the line or at the end of the line without any overload protection
- Not buried cable

The verify performed by the instrument DOES NOT replace in any case the project calculations

1. Select the options “TN, TT or “IT”, “25 or 50V”, “50Hz or 60Hz” and the reference voltage in the general settings of the instrument (see § 5.1.4).

Touch the icon. The screen to the side appears on the display.

Touch the lower icon. The following screen appears on the display:

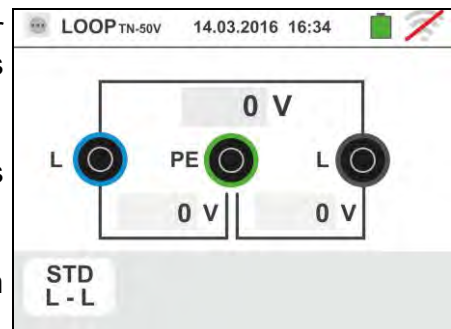

2. Move the left slide bar reference by selecting the icon to execute the measurement only with the instrument or the icon to execute the measurement with the instrument + optional accessory IMP57 (see § 6.4.10).

Move the central slide bar reference by selecting the “L-L”, “L-N” or “L-PE” options (for TN systems only).

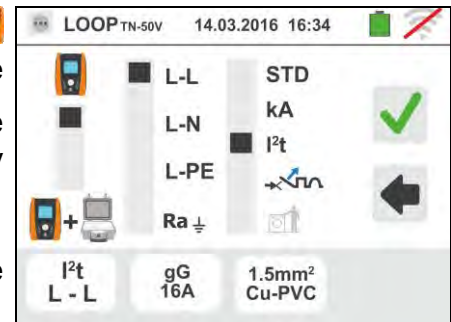



Move the right slide bar reference by selecting the “ I^2t ” option.

Touch the icon in the bottom center to set the protection type and its rated current. The following screen appears on the display:

3. Move the slide bar reference by selecting the type of protection (Fuse of type **gG** or **aM** or magnetothermal MCB in curve **B**, **C**, **K**, **D**).

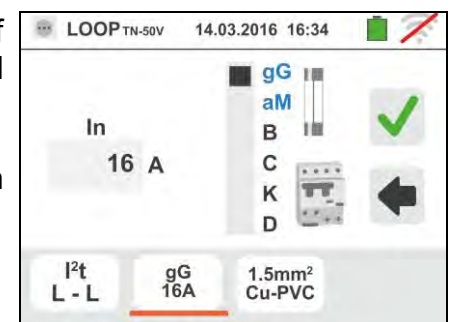
Touch the “In” field. The following screen appears on the display:



4. Touch the  icon to zero the value in the In field and use the virtual keyboard to set the value of the RCD rated current within the values allowed by the instrument.



The following selections are available on the instrument

- MCB current (B curve) selectable among: **6,10,13,15,16,20,25,32,40,50,63A**
- MCB current (C, K curves) selectable among: **0.5,1,1.6,2,4,6,10,13,15,16,20,25,32,40,50,63A**
- MCB current (D curve) selectable among: **0.5,1,1.6,2,4,6,10,13,15,16,20,25,32A**
- Nominal current Fuse gG selectable among: **2, 4, 6, 8, 10, 12, 13, 16, 20, 25, 32, 40, 50, 63, 80, 100, 125, 160, 200, 250, 315, 400, 500, 630, 800, 1000, 1250A**
- Nominal current Fuse aM selectable among: **2, 4, 6, 8, 10, 12, 16, 20, 25, 32, 40, 50, 63, 80, 100, 125, 160, 200, 250, 315, 400, 500, 630A**

Confirm the choice by going back to the previous screen.

Touch the icon in the bottom right corner to set the type, section and material forming the inner insulation of the cable of the line under test. The following screen appears on the display:

5. Touch the “**mm²**” field and, by using the virtual keyboard, set and confirm the section value of the single cable free selectable

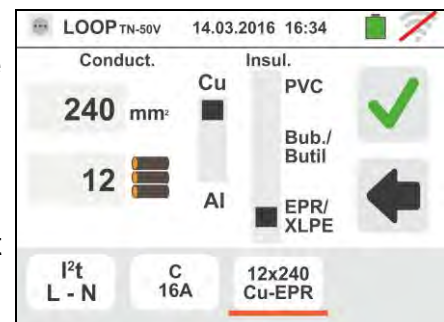

Touch the field “” and, by using the virtual keyboard, set and confirm the possible number of parallel cords. In the case that the circuit have only one conductor set the “**1**” value

Move the central slide bar reference by selecting the type of conductor. The available options are **Cu** (Copper) and **Al** (Aluminum).

Move the right slide bar reference by selecting the insulation type of the cable between the options: **PVC**, **Rub/Butil** (Rubber/Butyl rubber) and **EPR/XLPE** (Ethylene propylene rubber/Cross-linked polyethylene)

Confirm the choice by going back to the initial measurement screen.

6. If possible, disconnect all loads connected downstream of the measured point, as the impedance of these users could distort the test results. Connect the shuko plug, the alligator clips or the remote lead to the electrical mains according to Fig. 17, Fig. 18, Fig. 19 and Fig. 21. Note the presence of the correct voltage values between L-L and L-PE corresponding to the selections carried out in the initial phase (see § 5.1.4) as shown in the screen to the side

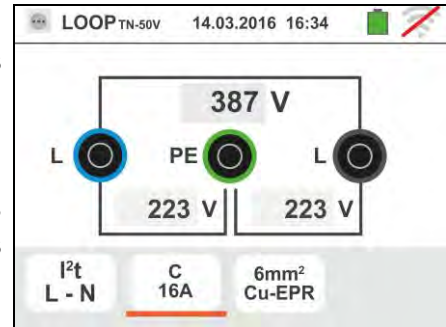

7. Press the **GO/STOP** key for 2s or the **START** key on the remote lead. During this whole stage, do not disconnect the measuring leads of the instrument from the system under test.

In case of positive result (three-phase short-circuit current for the L-L case in the image supported by the cable with the performed selections), the screen to the side is displayed by the instrument.



Press the **SAVE** button or touch the  icon to save the measurement (see § 7.1).

8. In case of negative result (three-phase Isc current for the L-L case in the image NOT supported by the cable with the performed selections), the screen to the side is displayed by the instrument.

Note the presence of the measurement result highlighted in red.

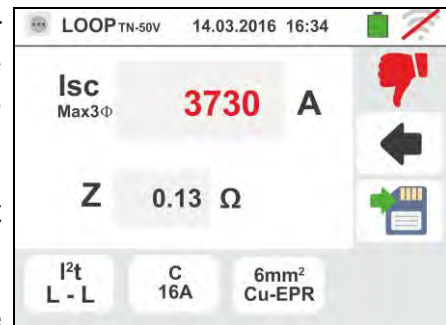

Press the **SAVE** button or touch the  icon to save the measurement (see § 7.1).

6.4.5. Mode - Verify of protection coordination

1. Select the reference country (see § 5.1.2), the options “TN, TT or “IT”, “25 or 50V”, “50Hz or 60Hz” and the reference voltage in the general settings of the instrument (see § 5.1.4). **NOTE: for “USA” country the TT and IT systems are not available**



Touch the icon. The screen to the side appears on the display.

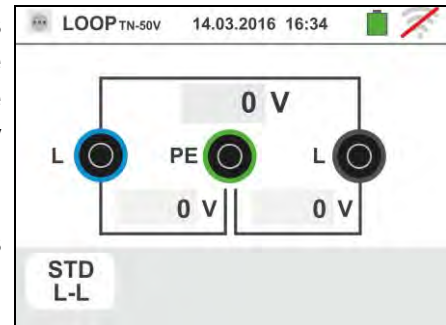

Touch the lower icon. The following screen appears on the display:

2. Move the left slide bar reference by selecting the icon to execute the measurement only with the instrument or the icon to execute the measurement with the instrument + optional accessory IMP57 (see § 6.4.10).

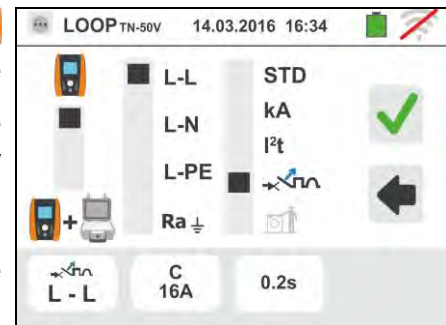

Move the central slide bar reference by selecting the “L-L”, “L-N” or “L-PE” options (for TN systems only).

Move the right slide bar reference by selecting the “” option.

Touch the icon in the bottom center to set the protection type and its rated current. The following screen appears on the display:

3. Move the slide bar reference by selecting the type of protection (Fuse of type **gG** or **aM** or magnetothermal MCB in curve **B**, **C**, **K**, **D**).

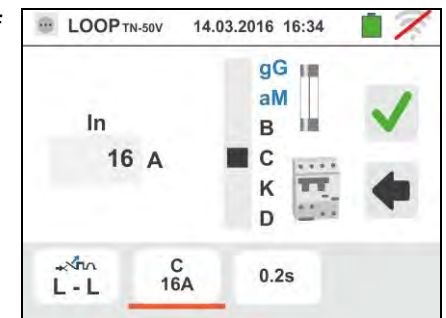

Touch the “In” field. The following screen appears on the display:

4. Touch the icon to zero the value in the In field and use the virtual keyboard to set the value of the RCD rated current within the values allowed by the instrument.

Confirm the choice by going back to the previous screen.



Touch the icon in the lower right corner to set the tripping time of the RCD. The following screen appears on the display:

5. Move the slide bar reference by selecting the protection tripping time between the options: **0.1s**, **0.2s**, **0.4s**, **1s**, **5s**.

Confirm the choice by going back to the initial measurement screen.

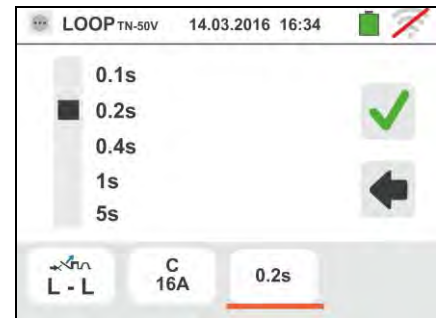

6. If possible, disconnect all loads connected downstream of the measured point, as the impedance of these users could distort the test results. Connect the shuko plug, the alligator clips or the remote lead to the electrical mains according to Fig. 17, Fig. 18, Fig. 19 and Fig. 21 in the farthest possible point respect the protection on test

Note the presence of the correct voltage values between L-L and L-PE corresponding to the selections carried out in the initial phase (see § 5.1.4) as shown in the screen to the side.

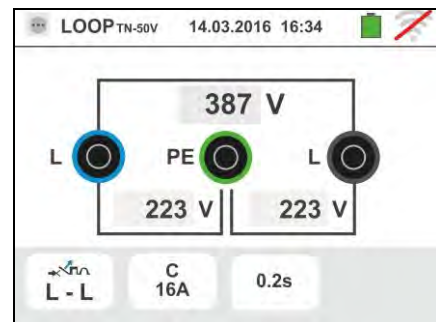

7. Press the **GO/STOP** key for 2s or the **START** key on the remote lead. During this whole stage, do not disconnect the measuring leads of the instrument from the system under test.

In case of positive result (minimum short-circuit current interrupted by the protection device within the time indicated by the performed selections), the screen to the side is displayed by the instrument.

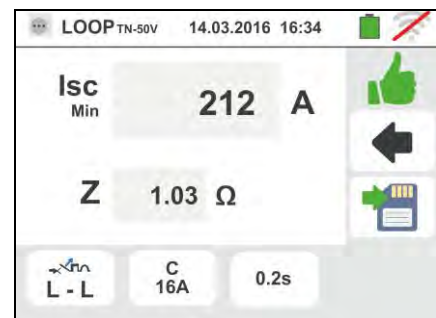

Press the **SAVE** button or touch the  icon to save the measurement (see § 7.1).

8. In case of negative result (minimum short-circuit current NOT interrupted by the protection device within the time indicated by the performed selections), the screen to the side is displayed by the instrument.

Note the presence of the measurement result highlighted in red.



Press the **SAVE** button or touch the  icon to save the measurement (see § 7.1).

6.4.6. Mode - Verify of protection coordination – Norway country

1. Select the “Norway” country (see § 5.1.2), the options “TN, or “IT”, “25 or 50V”, “50Hz or 60Hz” and the reference voltage in the general settings of the instrument (see § 5.1.4)

Touch the lower first icon. The following screen appears on the display.

:

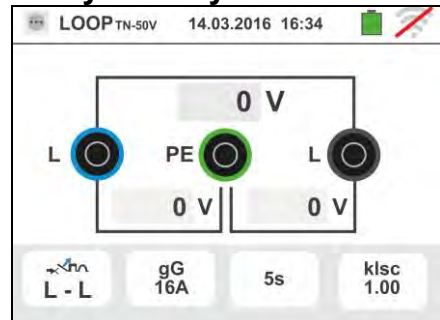

2. Move the left slide bar reference by selecting the icon to execute the measurement only with the instrument or the icon to execute the measurement with the instrument + optional accessory IMP57 (see § 6.4.10).

Move the central slide bar reference by selecting the “L-L”, “L-N” or “L-PE” options (for TN systems only).

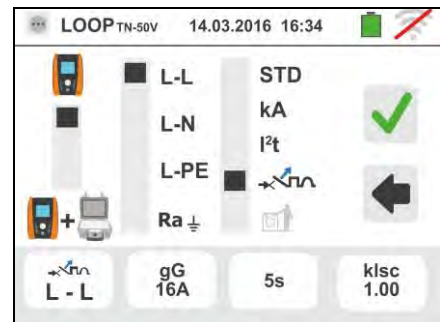

Move the right slide bar reference by selecting the "" option.

Touch the second icon to set the protection type and its rated current. The following screen appears on the display:

3. Move the slide bar reference by selecting the type of protection (Fuse of type **gG** or **aM** or magnetothermal MCB in curve **B**, **C**, **K**, **D**).

Touch the “In” field. The following screen appears on the display:

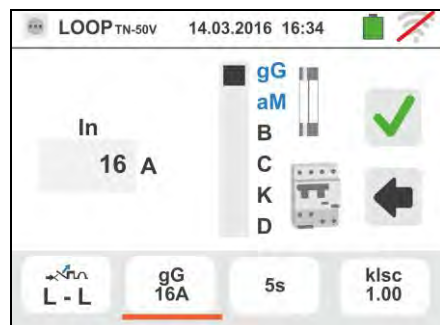

4. Touch the icon to zero the value in the In field and use the virtual keyboard to set the value of the RCD rated current within the values allowed by the instrument.

Confirm the choice by going back to the previous screen.

Touch the third icon to set the tripping time of the RCD. The following screen appears on the display:



5. Move the slide bar reference by selecting the protection tripping time between the options: **0.1s**, **0.2s**, **0.4s**, **1s**, **5s**.

Confirm the choice by going back to the initial measurement screen.

Touch the fourth icon to set the calculation coefficient of the short circuit current **I_{sc}**. The following screen appears on the display

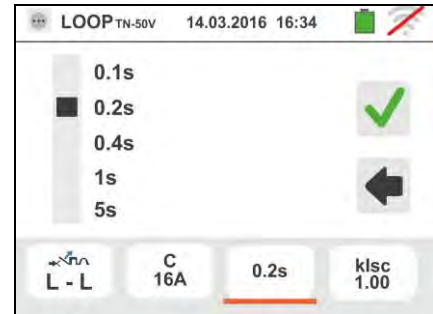

6. Touch the  icon to zero the value in the field and use the virtual keyboard to set the calculation coefficient of the short circuit current **I_{sc}** within the values allowed by the instrument

Confirm the choice by going back to the initial measurement screen



7. If possible, disconnect all loads connected downstream of the measured point, as the impedance of these users could distort the test results. Connect the shuko plug, the alligator clips or the remote lead to the electrical mains according to Fig. 17, Fig. 18, Fig. 19 and Fig. 21 in the farthest possible point respect the protection on test

Note the presence of the correct voltage values between L-L and L-PE corresponding to the selections carried out in the initial phase (see § 5.1.4) as shown in the screen to the side.

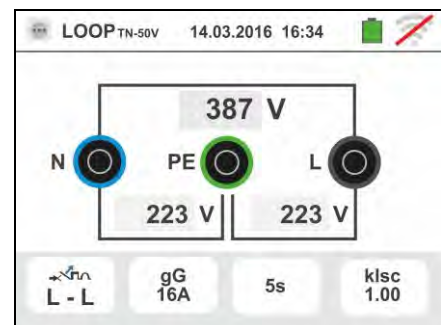

8. Press the **GO/STOP** key for 2s or the **START** key on the remote lead. During this whole stage, do not disconnect the measuring leads of the instrument from the system under test.

In case of positive result (minimum short-circuit current interrupted by the protection device within the time indicated by the performed selections), the screen to the side is displayed by the instrument.

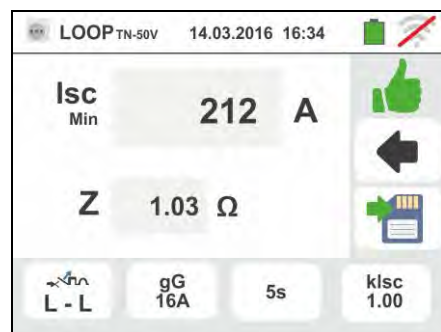

Press the **SAVE** button or touch the  icon to save the measurement (see § 7.1).

9. In case of negative result (minimum short-circuit current NOT interrupted by the protection device within the time indicated by the performed selections), the screen to the side is displayed by the instrument.
Note the presence of the measurement result highlighted in red.

Press the **SAVE** button or touch the  icon to save the measurement (see § 7.1).

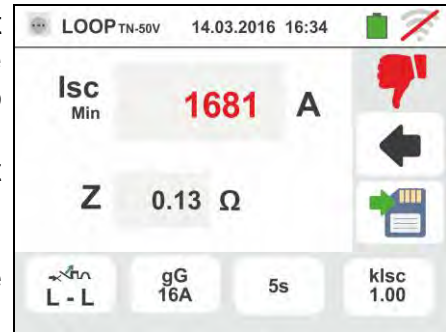



6.4.7. Verify of protection against indirect contacts (TN system)

1. Select the options "TN", "25 or 50V", "50Hz or 60Hz" and the reference voltage in the general settings of the instrument (see § 5.1.4).

Touch the  icon. The screen to the side appears on the display.

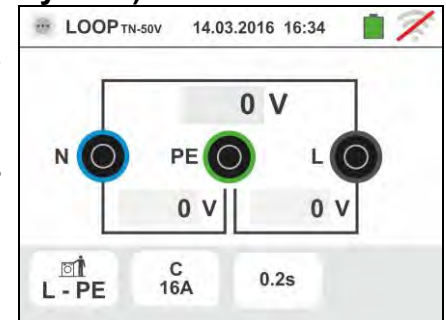
Touch the lower icon. The following screen appears on the display:



2. Move the left slide bar reference by selecting the  icon to execute the measurement.

Move the central slide bar reference by selecting the "L-PE" option. The right slide bar reference is automatically set in position .

Confirm the choice by going back to the initial measurement screen.

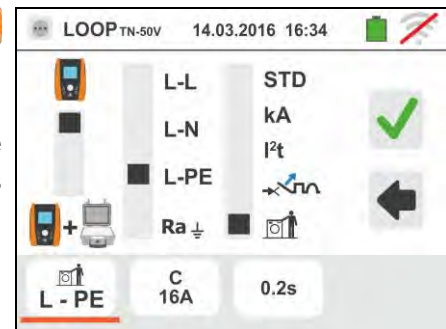

3. Move the slide bar reference by selecting the type of protection (Fuse of type **gG** or **aM** or magnetothermal MCB in curve **B**, **C**, **K**, **D**).

Touch the "In" field. The following screen appears on the display

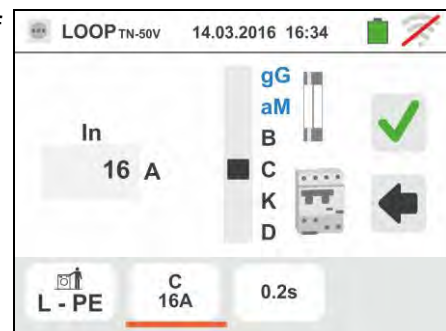

4. Touch the  icon to zero the value in the In field and use the virtual keyboard to set the value of the nominal current of the protection within the values allowed by the instrument (see § 6.4.4)

Confirm the choice by going back to the previous screen.

Touch the icon in the lower right corner to set the tripping time of the protection. The following screen appears on the display

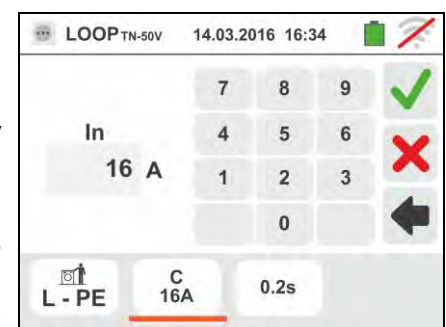

5. Move the slide bar reference by selecting the protection tripping time between the options: **0.1s**, **0.2s**, **0.4s**, **1s**, **5s**.

Confirm the choice by going back to the initial measurement screen

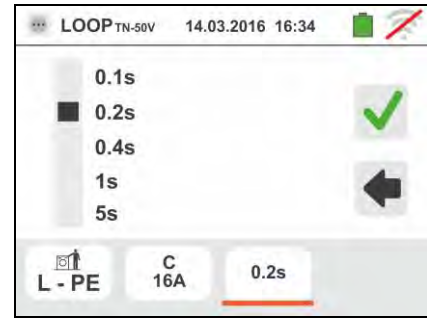

6. If possible, disconnect all loads connected downstream of the measured point, as the impedance of these users could distort the test results. Connect the alligator clips or the remote lead to the electrical mains according to Fig. 17, Fig. 18, Fig. 19 and Fig. 21 in the farthest possible point respect the protection on test.

Note the presence of the correct voltage values between L-N and L-PE corresponding to the selections carried out in the initial phase (see § 5.1.4) as shown in the screen to the side.

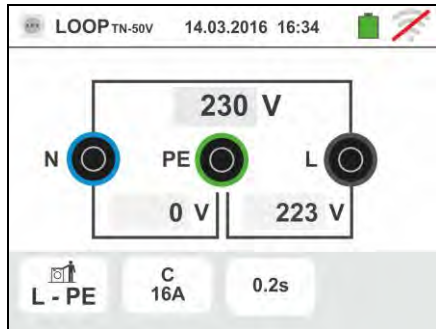

7. Press the **GO/STOP** key for 2s or the **START** key on the remote lead. During this whole stage, do not disconnect the measuring leads of the instrument from the system under test.

In case of positive result (calculated minimum short-circuit current **HIGHER** than tripping current of the protection device within the specified time – see § 13.6), the screen to the side is displayed by the instrument

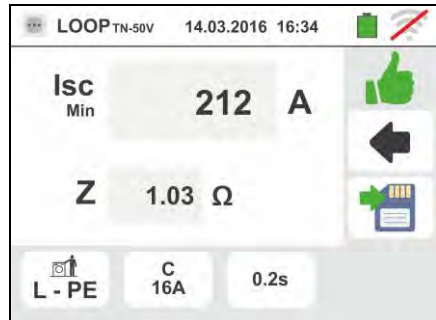

Press the **SAVE** button or touch the  icon to save the measurement (see § 7.1).

8. In case of negative result (calculated minimum short-circuit current **LOWER** than tripping current of the protection device within the specified time – see § 13.6), the screen to the side is displayed by the instrument

Press the **SAVE** button or touch the  icon to save the measurement (see § 7.1).

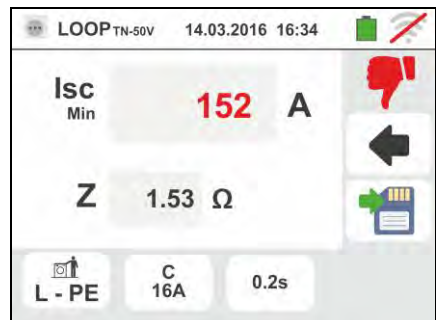

6.4.8. Verify of protection against indirect contacts (IT systems)

1. Select the options "IT", "25 or 50V", "50Hz or 60Hz" and the reference voltage in the general settings of the instrument (see § 5.1.4).

Touch the  icon. The screen to the side appears on the display.

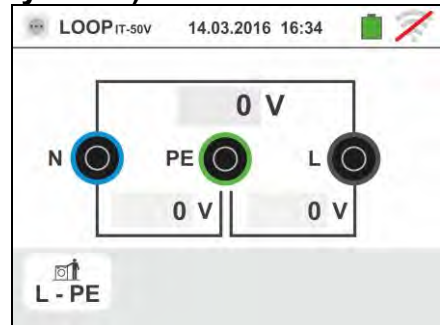

Touch the lower icon. The following screen appears on the display:

2. Move the left slide bar reference by selecting the  icon to execute the measurement.

Move the central slide bar reference by selecting the "L-PE" option. The right slide bar reference is automatically set in position .

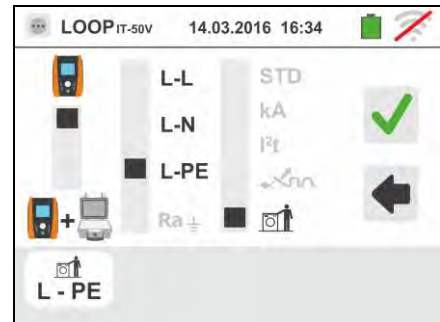

Confirm the choice by going back to the initial measurement screen.

3. If possible, disconnect all loads connected downstream of the measured point, as the impedance of these users could distort the test results. Connect the alligator clips or the remote lead to the electrical mains according to Fig. 22. Note the presence of the correct voltage values between L-L and L-PE corresponding to the selections carried out in the initial phase (see § 5.1.4) and a possible N-PE voltage due to the IT system as shown in the screen to the side.

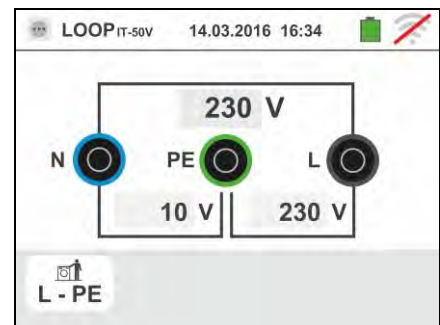

4. Press the **GO/STOP** key for 2s or the **START** key on the remote lead. During this whole stage, do not disconnect the measuring leads of the instrument from the system under test.

In case of positive result (contact voltage at the point <50V or <25V), the screen to the side is displayed by the instrument, which contains the value of the first fault current measured, expressed in **mA** (see § 13.8). **With $I_{sc} < 30\text{mA}$ the U_t value is not displayed**

Press the **SAVE** button or touch the  icon to save the measurement (see § 7.1).

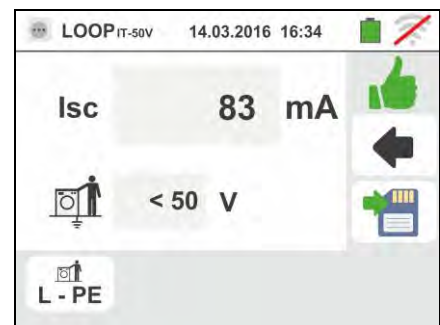

5. In case of negative result (contact voltage at the point >50V or >25V), the screen to the side is displayed by the instrument.

Note the presence of the measurement result of the contact voltage highlighted in red.

Press the **SAVE** button or touch the  icon to save the measurement (see § 7.1).

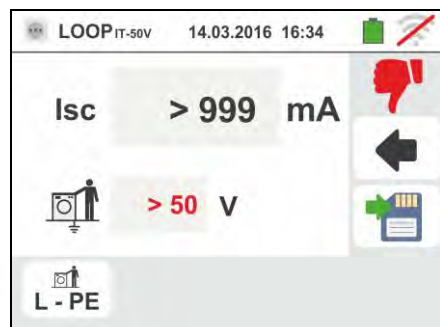



6.4.9. Verify of protection against indirect contacts (TT systems)

1. Select the options "TT", "25 or 50V", "50Hz or 60Hz" and the reference voltage in the general settings of the instrument (see § 5.1.4).

Touch the  icon. The screen to the side appears on the display.

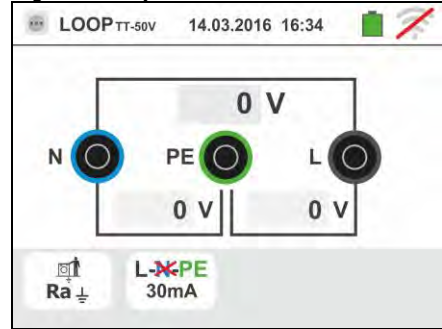
Touch the lower icon on the left. The following screen appears on the display:



2. Move the left slide bar reference by selecting the  icon to execute the measurement.

Move the middle slide bar reference by selecting the "Ra" option. The right slide bar reference is automatically set in position .

Confirm the choice by going back to the initial measurement screen.

Touch the lower icon on the right. The following screen appears on the display:

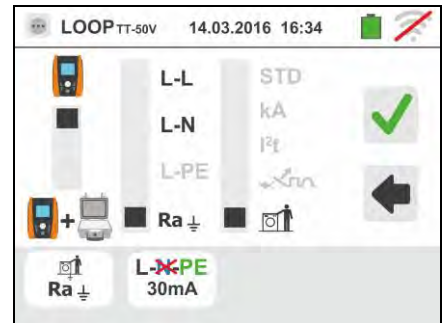

3. Move the left slide bar reference by selecting the RCD tripping current between the values: **10, 30, 100, 300, 500, 650, 1000mA**

Move the right slide bar reference by selecting the connection type between the options: **L-N-PE** (presence of neutral conductor) or **L-N-PE** (absence of neutral conductor)

Confirm the choices by going back to the initial measurement screen.

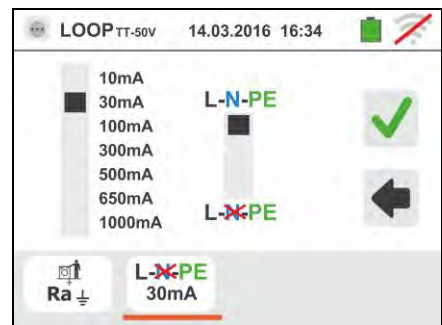

4. If possible, disconnect all loads connected downstream of the measured point, as the impedance of these users could distort the test results. Connect the shuko plug, the alligator clips or the remote lead to the electrical mains according to Fig. 10, Fig. 12 and Fig. 13. The connection point of the instrument (near or far from the protection) is usually irrelevant to the test as the resistance of the wires is negligible compared to the value of earth resistance.

Note the presence of the correct voltage values between L-L and L-PE corresponding to the selections carried out in the initial phase (see § 5.1.4) as shown in the screen to the side.

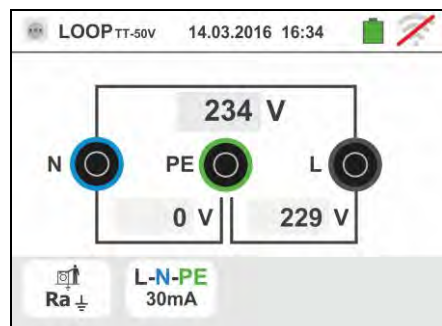

5. Press the **GO/STOP** key for 2s or the **START** key on the remote lead. During this whole stage, do not disconnect the measuring leads of the instrument from the system under test.

In case of positive result (overall earth resistance lower than the ratio between limit contact voltage and RCD tripping current), the screen to the side is displayed by the instrument, which contains the contact voltage value in the secondary display.

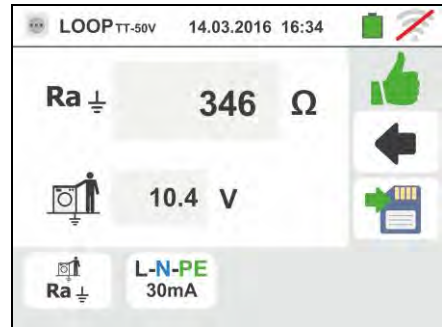

Press the **SAVE** button or touch the  icon to save the measurement (see § 7.1).

6. In case of negative result (overall earth resistance higher than the ratio between limit contact voltage and RCD tripping current), the screen to the side is displayed by the instrument.

Note the presence of the measurement result of the contact voltage highlighted in red.



Press the **SAVE** button or touch the  icon to save the measurement (see § 7.1).

6.4.10. Impedance measurement by means of the accessory IMP57

Impedance measurements performed with the optional accessory IMP57 involve its connection to the instrument via optical connector through the optical cable/RS-232 C2001 supplied with same accessory.

The IMP57 must be directly powered by the mains on which measurements are performed. For detailed information, please refer to the user manual of the accessory IMP57.

Please find below the procedure for the measurement of **STD L-L impedance in TN systems**. The same procedures can be applied to any other case considering what is reported in previous chapters.

1. Select the options "TN", "25 or 50V", "50Hz or 60Hz" and the reference voltage in the general settings of the instrument (see § 5.1.4).

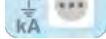

Touch the  icon. The screen to the side appears on the display.

Touch the lower icon on the left. The following screen appears on the display:

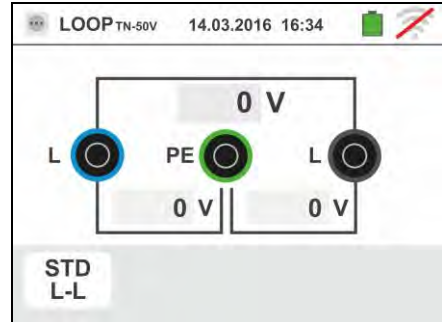

2. Move the left slide bar reference by selecting the  icon to execute the measurement with the accessory IMP57.

Move the central slide bar reference by selecting the "L-L" option.

Move the right slide bar reference by selecting the "STD" option.

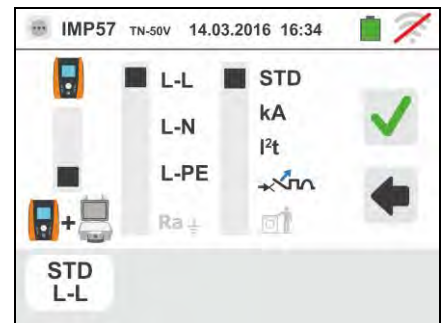

Confirm the choice by going back to the following initial measurement screen.

3. The  symbol on the display indicates that the accessory IMP57 is not connected to the instrument or not powered directly by the mains.

Connect the IMP57 to the instrument via the cable C2001 and to the powered system via the input terminals **C1**, **C2** and **P1**, **P2** placed on it (see the IMP57 user manual). The following screen appears on the display:

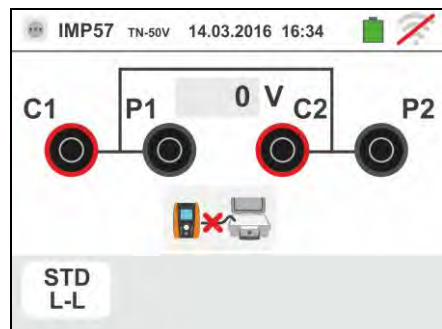

4. The  symbol indicates the correct connection and recognition of the IMP57 by the instrument. Check the green STATUS LED lighting on the IMP57.

The value of the voltage between the measurement points is shown in the upper part of the display.

Press the **GO/STOP** key on the instrument to start the test. The following screen is shown on the display (in case of L-L measurement in STD mode)

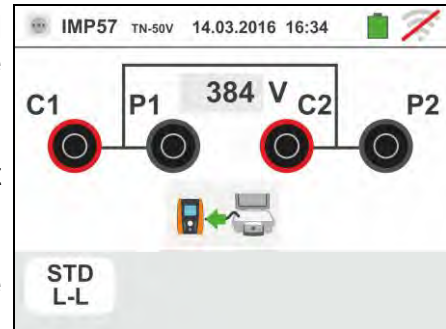

5. The standard (STD) short-circuit current is shown in the upper part of the display.

The P-P Loop impedance values, in addition to its resistive and reactive components, are shown in the central part of the display, expressed in **mΩ**.

Press the **SAVE** button or touch the  icon to save the measurement (see § 7.1).



6.4.11. Anomalous situations

1. If the instrument detects an L-N or L-PE voltage higher than the maximum limit (265V), it does not carry out the test and displays a screen like the one to the side. Check the connection of measuring cables.

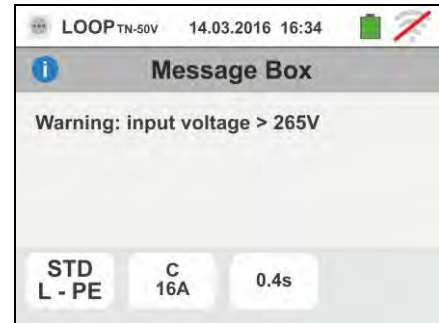

2. If the instrument detects an L-N or L-PE voltage lower than the minimum limit (100V), it does not carry out the test and displays a screen like the one to the side. Check that the system being tested is supplied.

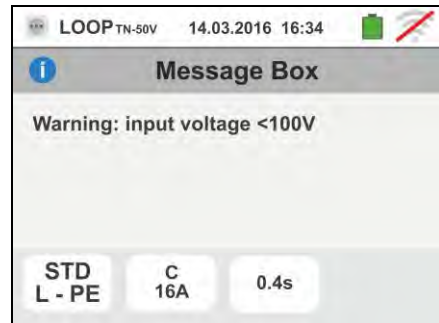

3. If the instrument detects the absence of the signal to terminal B1 (phase conductor), it provides the warning screen shown to the side and blocks the execution of the tests.

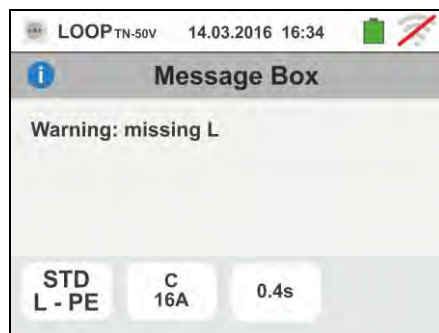

4. If the instrument detects the absence of the signal to terminal B4 (neutral conductor), it provides the warning screen shown to the side and blocks the execution of the tests.

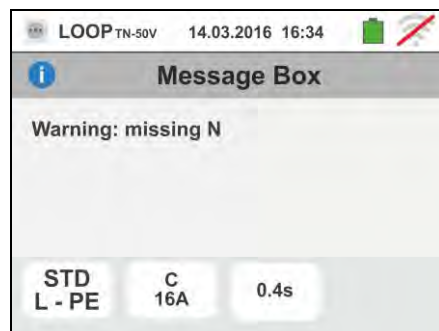

5. If the instrument detects the absence of the signal to terminal B3 (PE conductor), it provides the warning screen shown to the side and blocks the execution of the tests.

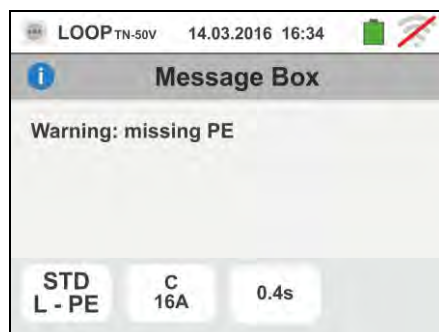

6. If the instrument detects that the phase and neutral leads are inverted, it does not carry out the test and a screen similar to the one reported to the side is displayed. Rotate the shuko plug or check the connection of measuring cables.



7. If the instrument detects that the phase and PE leads are inverted, it does not carry out the test and a screen similar to the one reported to the side is displayed. Check the connection of measuring cables.

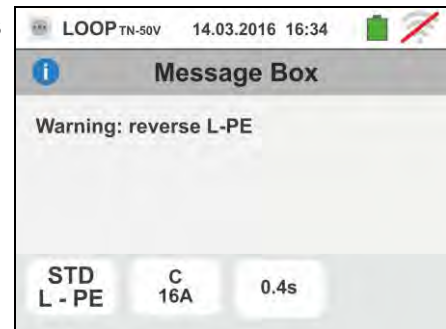

8. If the instrument detects a danger voltage on PE conductor, it does not carry out the test and displays a screen like the one to the side. This message can also appear in case of an insufficient pressure of the **GO/STOP** key

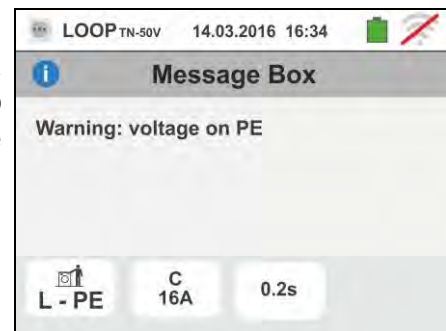

9. If the instrument detects a voltage $V_{N-PE} > 50V$ (or $> 25V$ depending on the selection), it does not carry out the test and displays a screen like the one to the side

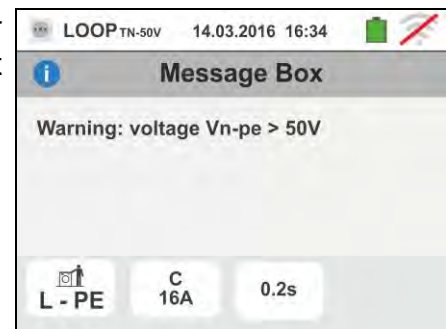

6.5. SEQ: PHASE SEQUENCE AND PHASE CONCORDANCE TEST

This function is performed in compliance with standards IEC/EN61557-7 and allows testing the phase sequence and concordance by direct contact with live parts (**not on cables with insulating sheath**). The following operating modes are available:



CAUTION

- The instrument can be used for measurements on installations with overvoltage category CAT IV 300V to earth and max 600V between inputs. Do not connect the instrument on installations with voltage exceeding the limits indicated in this manual. Exceeding these limits could cause electrical shock to the user and damage to the instrument.
- The connection of the test leads to the instrument and to the alligator clips must always be done with accessories disconnected by the installation

- 1T one lead measurement
2T two leads measurement.

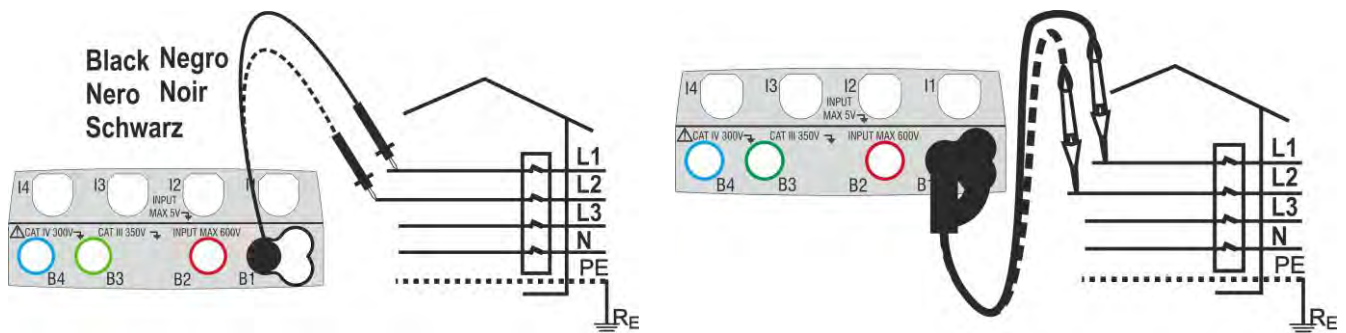

Fig. 23: Phase sequence check of 1T phases with terminal and remote lead

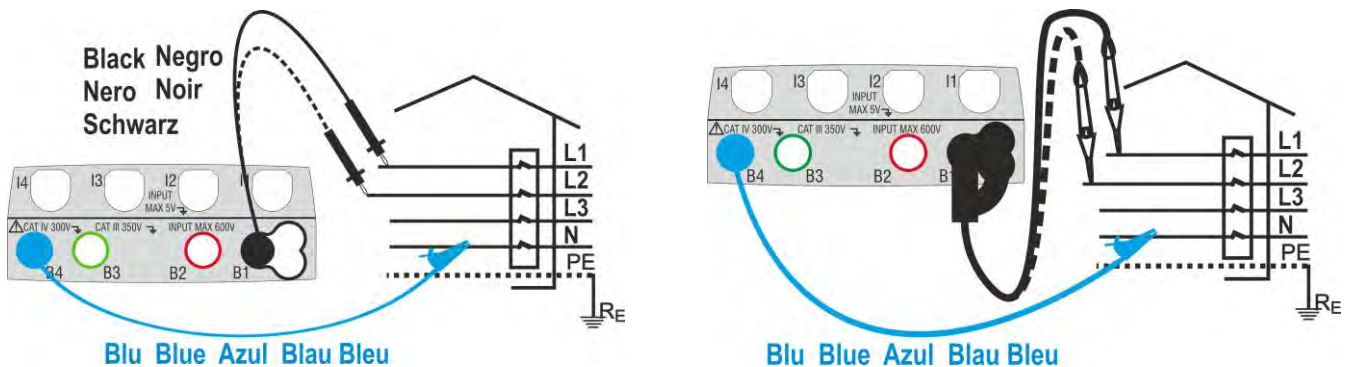



Fig. 24: Phase sequence check of 2T phases with terminal and remote lead

1. Touch the  icon. The screen to the side appears on the display.

Touch the “1T” icon to set the measuring mode. The following screen appears on the display:



2. Move the slide bar reference in the position "1T" for the selection of the test with 1 terminal or in the position "2T" for the selection of the test with 2 terminals.

Confirm the choice by going back to the following initial measurement screen.

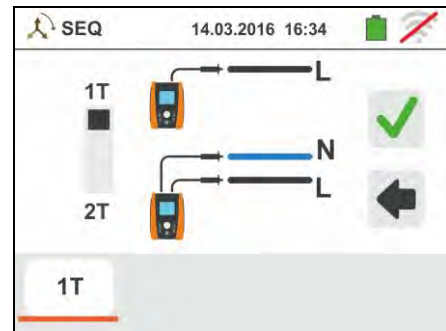

3. Insert the blue and black connectors of the single cables in the corresponding input terminals of the instrument B4, B1 (2T measurement). Insert in the free end of the cables the corresponding alligator clips or tips. It is also possible to use the remote lead by inserting its multipolar connector into the input lead B1. Connect the alligator clips, the tips or the remote lead to phase L1 and N according to Fig. 23 and Fig. 24.

4. Press the **GO/STOP** key on the instrument or the **START** key on the remote lead. The instrument will start the measurement. During this whole stage, do not disconnect the measuring leads of the instrument from the system under test.

The symbol for the tip on phase L1 and the hourglass indicating the status of pending recognition of a voltage higher than the maximum allowed.

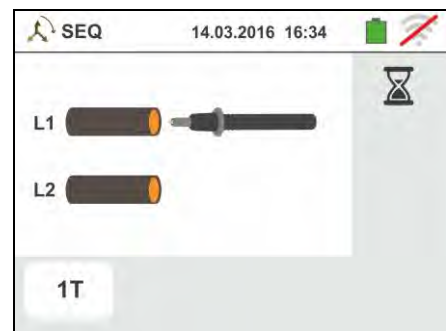

5. Once the correct voltage recognized, the  symbol is shown on the display. The instrument gives out a long sound until input voltage is present.

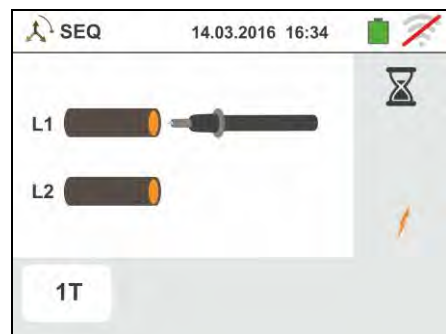

6. At the end of phase L1 acquisition, the instrument is in standby waiting for the signal on phase L2 and showing the symbol of "disconnected tip" as shown in the screen to the side.

Under these conditions, connect the alligator clips, the tips or the remote lead to phase L2 and N in accordance with Fig. 23 and Fig. 24.

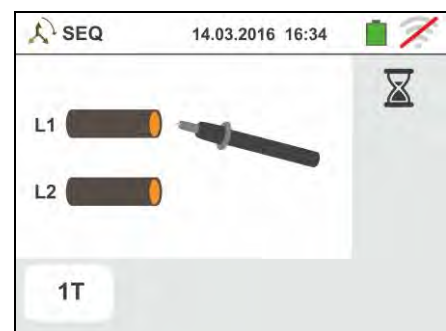

7. The symbol for the tip on phase L2 and the hourglass indicating the status of pending recognition of a voltage higher than the maximum allowed.

Once the correct voltage recognized, the  symbol is shown on the display.

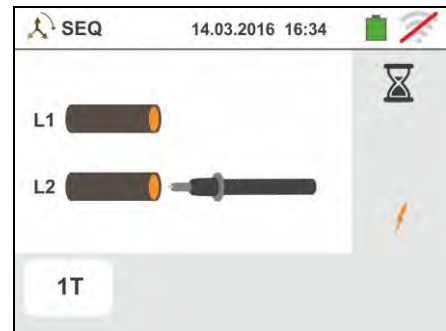

8. At the end of the test, if the detected phase sequence is correct, the instrument displays a screen like the one shown to the side (result "1-2-3").

Press the **SAVE** button or touch the  icon to save the measurement (see § 7.1).



9. At the end of the test, if the two detected voltages are in phase (**phase concordance between two distinct three-phase systems**), the instrument displays a screen like the one to the side (result "1-1-").



- 10 At the end of the test, if the detected phase sequence is not correct, the instrument displays a screen like the one shown to the side (result "2-1-3").

Press the **SAVE** button or touch the  icon to save the measurement (see § 7.1).



6.5.1. Anomalous situations

1. If between the test start and the acquisition of the first voltage or between the acquisition of the first and second voltage, a time longer than around 10s has elapsed, the instrument displays a screen like the one to the side.

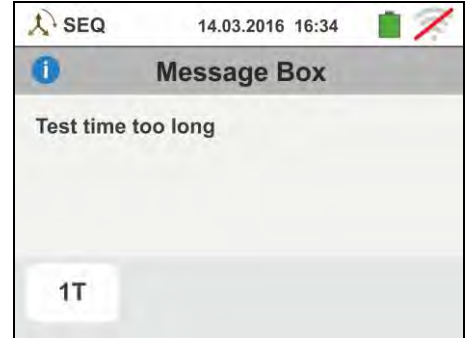

2. If the instrument detects an input voltage higher than the maximum limit, it will display a screen like the one to the side.



3. If the instrument detects an input voltage frequency exceeding the allowed full scale, it will display a screen like the one to the side.



6.6. LEAKAGE: LEAKAGE CURRENT MEASUREMENT AND RECORDING

This function allows measuring and recording the leakage current in single-phase or three-phase systems by means of the optional accessory HT96U clamp.

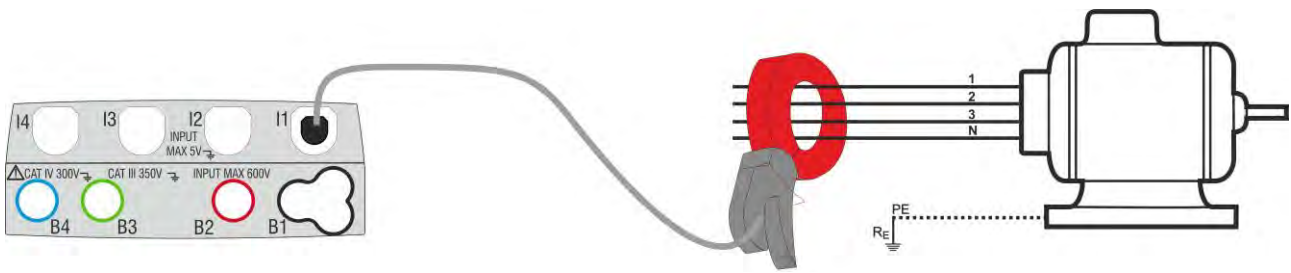

Fig. 25: Indirect measurement of leakage current in three-phase systems

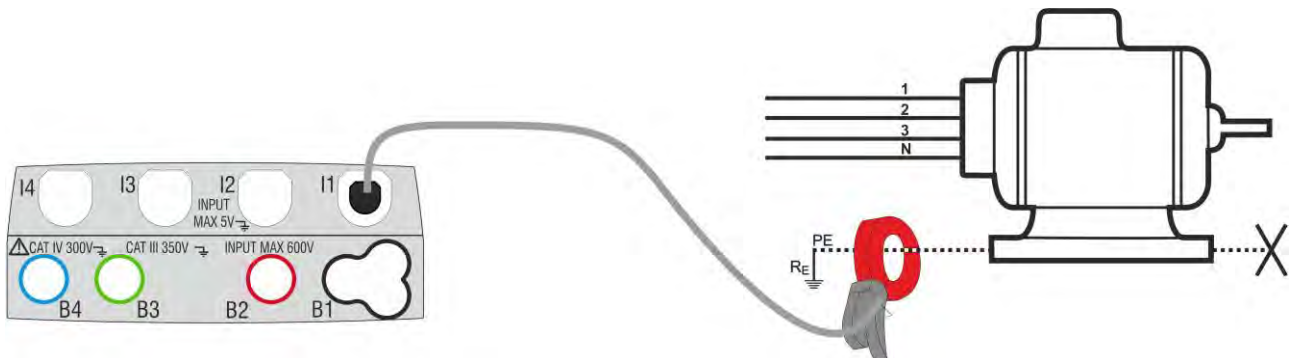

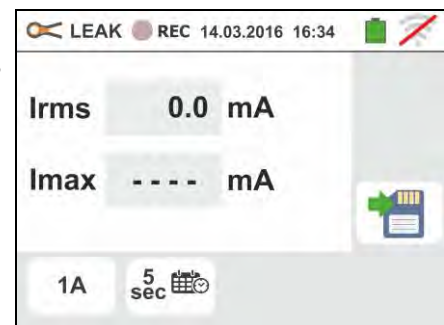





Fig. 26: Direct measurement of leakage current in three-phase systems

1. Touch the  icon. The screen to the side appears on the display.

Touch the  icon to set the full scale of the used clamp. The following screen appears on the display:



2. Touch the arrow keys  or  to set the full scale value of the selected HT96U clamp in the 1A ÷ 3000A range. Press and hold the keys for a quick selection of values

Touch the  icon to set recording parameters. The following screen appears on the display

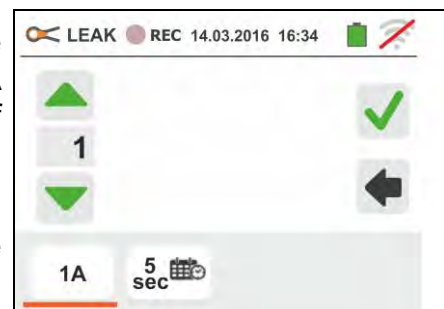

:

3. Move the left slide bar cursor in order to select the aggregation time (see § 13.16) among the options: **2s, 5s, 10s, 30s, 1min, 2min, 5min, 10min, 15min, 30min**

Move the central slide bar cursor (“**GO**” symbol) to the positions:

- → **Manual** start of recording by pressing the **GO/STOP** key (at the next minute after the pressure of key)
- → **Automatic** start of recording at the date/time set by the user (after a preliminary pressure of **GO/STOP** key in order to set the instrument in stand-by mode). **Touch the corresponding field to set the date/time** in the “MM:DD:YY HH:MM” format and confirm

Move the right slide bar cursor (“**STOP**” symbol) in the positions:

- → **Manual** stop of recording by pressing the **GO/STOP** key
- → **Automatic** stop of recording at the date/time set by the user. **Touch the corresponding field to set the date/time** in the “MM:DD:YY HH:MM” format and confirm

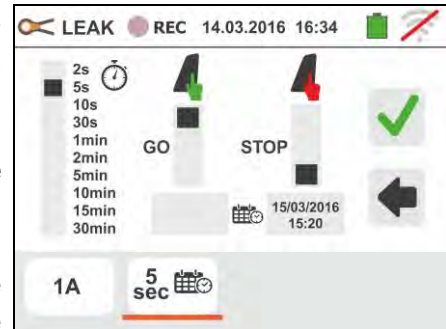

4. Insert the external clamp into instrument input **I1**
5. For indirect measurements of leakage current, connect the external clamp according to Fig. 25. For direct measurements of leakage current, connect the clamp according to Fig. 26 and disconnect possible additional earth connections that could influence the test results.



CAUTION

Possible additional earth connections could influence the measured value. In case of real difficulty in removing them, we recommend performing the measurement in an indirect way.

6. The real time value of the measured leakage current (I_{rms}) and it's maximum value (I_{max}) appears on the display as shown in the screen to the side.

Press the **SAVE** button or touch the icon to save the measurement (see § 7.1).



7. Press the **GO/STOP** key to start recording. The instrument enters stand-by mode (waiting for the next minute or the set date/time) and the “” symbol is displayed as shown in the screen to the side.

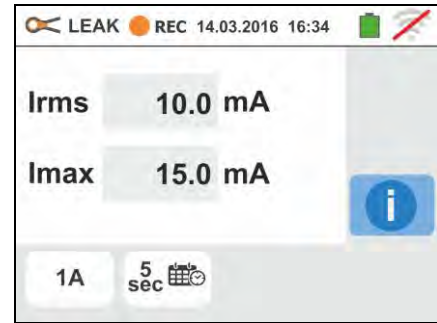

8. With recording running, the “” symbol is displayed as shown in the screen to the side.

Touch the “” icon to read in real time the information about on-going recording. The following screen appears on the display

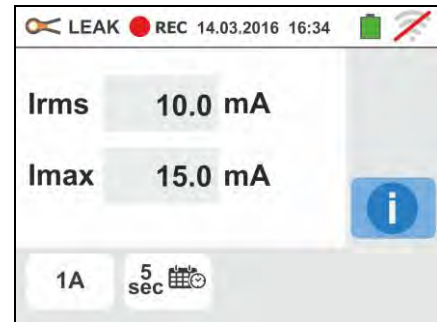

9. The screen contains:

- The number of recording
- The date/time of recording start (if automatic)
- The date/time of recording stop (if automatic)
- The aggregation time set
- The number of aggregation intervals recorded
- The residual memory capacity expressed in DD-HH-MM



- 10 Press **GO/STOP** key to stop recording; the instrument automatically saves the result in its memory (see § 7.1.3). The message to the side is shown.

Confirm by touching the “” icon or touch the “” icon to go back to the previous screen



6.7. EARTH: MEASUREMENT OF EARTH RESISTANCE

The instrument allows performing the measurement of earth resistance of an installation in the following ways:

- Measurement of earth resistance with 3-wire or 2-wire voltammetric method
- Measurement of ground resistivity (ρ) with Wenner 4-wire method
- Measurement of resistance of individual rods without disconnecting them by means of the optional clamp T2100

6.7.1. 3-wire or 2-wire earth measurement and 4-wire ground resistivity

The measurement is carried out in compliance with standards IEC/EN61557-5.

CAUTION



- The instrument can be used for measurements on installations with overvoltage category CAT III 300V to earth with a maximum voltage of 600V between inputs. Do not connect the instrument to installations with voltages exceeding the limits indicated in this manual. Exceeding these limits could result in electrical shocks to the user and damage to the instrument.
- Always connect the measuring cables to the instrument and to the alligator clips with the accessories disconnected from the system.
- We recommend holding the alligator clip respecting the safety area created by the hand protection (see § 4.2).
- If the length of the cables supplied is not suitable for the installation under test, you can create your own extensions following the indications in § 13.12.

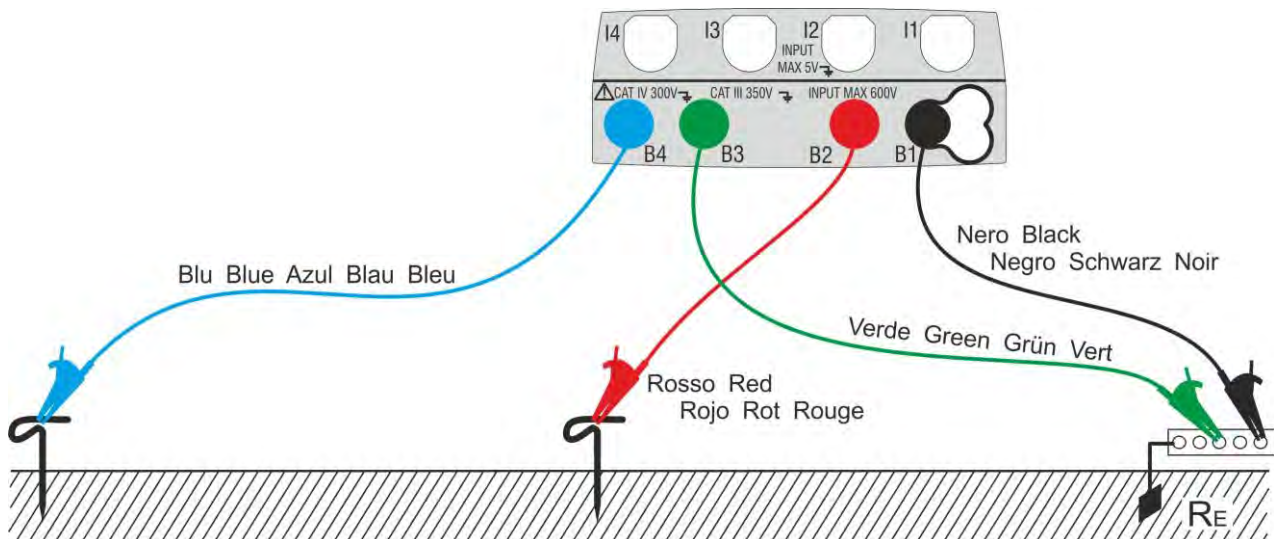

Fig. 27: Three-wire earth resistance measurement

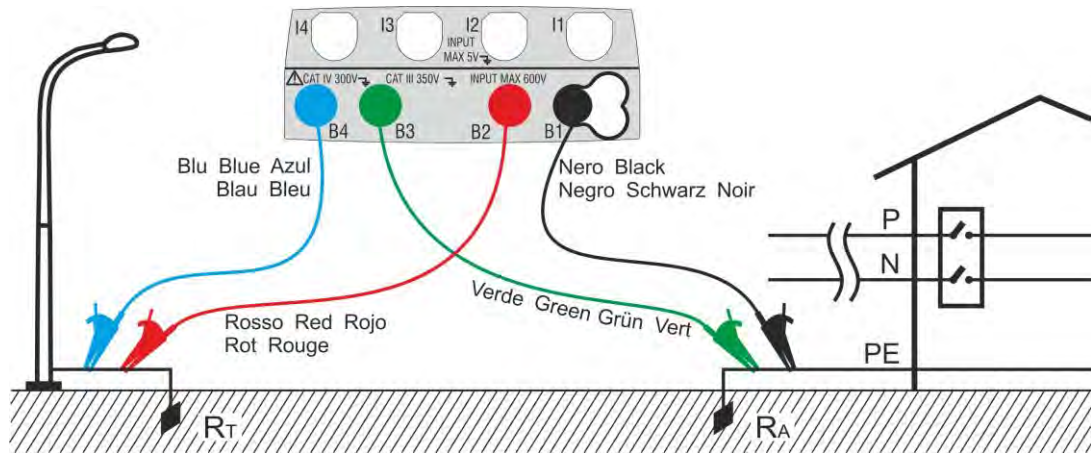

Fig. 28: Two-wire earth resistance measurement using an auxiliary rod

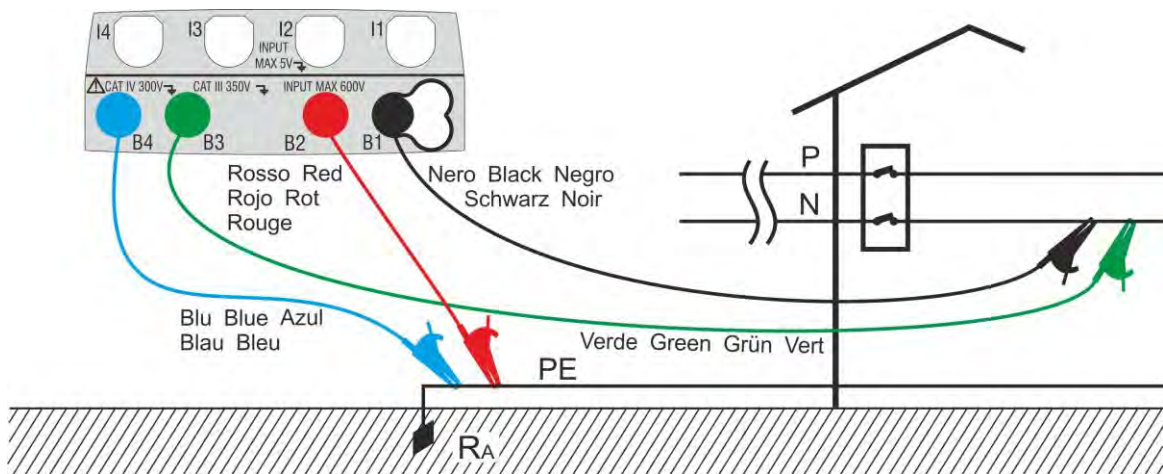

Fig. 29: Two-wire earth resistance measurement from the panel board

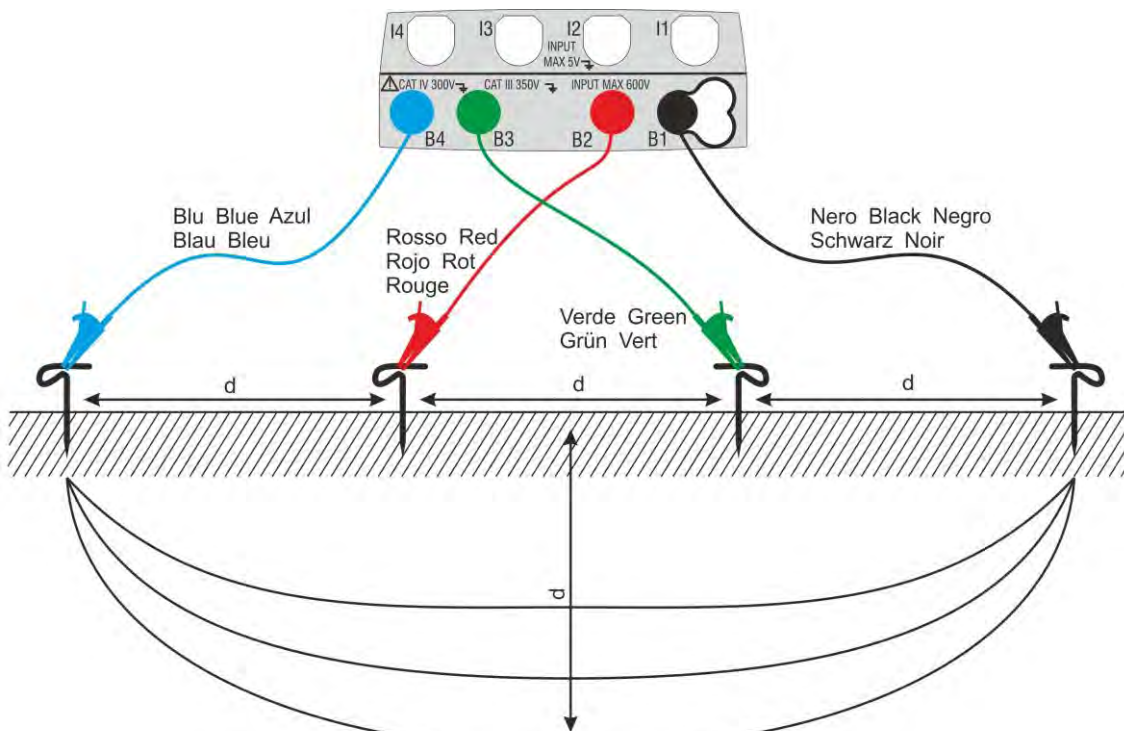

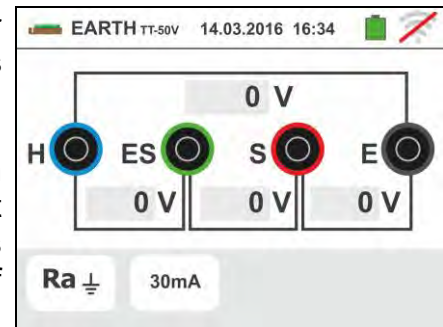



Fig. 30: Ground resistivity measurement

1. Select the options “TN, TT or “IT”, “25 or 50V”, “50Hz or 60Hz” and the reference voltage in the general settings

of the instrument (see § 5.1.4). Touch the  icon. The screen to the side (**TT and IT systems**) is shown on the display. The instrument automatically carries out the test in presence of voltage between the inputs (shown on the display) and blocks the test in case of voltage higher than 10V

Touch the first icon in the lower left corner to set the measuring mode. The following screen appears on the display:



2. Move the slide bar reference in the position "**Ra**" for the selection of the earth measurement with voltammetric method, in the  position for the resistance measurement with use of optional clamp T2100 (see § 6.7.3) or in the "ρ" position for the measurement of ground resistivity. Confirm the choice by going back to the initial measurement screen.

Touch the second icon in the lower left corner to set the tripping current of the differential switch (**TT and IT systems**). The following screen appears on the display:





3. Move the slide bar reference in the position corresponding to the value of the tripping current of the RCD differential switch as shown in the screen to the side. On the basis of this selection and the value of contact voltage (25V or 50V), the instrument performs the calculation of the limit value of earth resistance (see § 13.11) that will compare with the measured value in order to provide the final positive or negative result of the measurement.

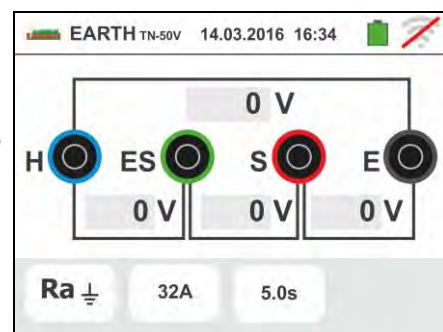

4. For **TN systems**, the instrument shows the initial screen as in the figure to the side.

Touch the central icon to set the rated current of the RCD. The following screen appears on the display:



5. Touch the  icon to zero the value in the "A" field and use the virtual keyboard to set the value of fault current (declared by the Energy distribution board) between **1A** and **9999A**. Confirm the choice by going back to the initial measurement screen.

Touch the icon in the lower right corner to set the tripping time of the RCD. The following screen appears on the display:

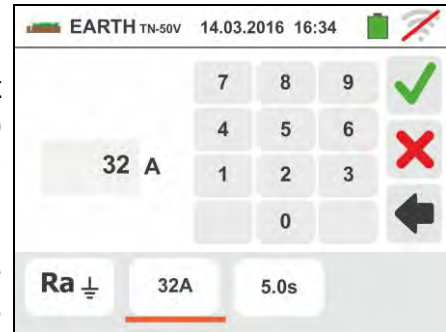

6. Touch the  icon to zero the value in the "s" field and use the virtual keyboard to set the value of the time for fault elimination **t** (declared by the Energy distribution board) between **0.04s** and **10s**.

On the basis of previous selections, the instrument performs the calculation of the maximum limit of earth resistance according to the value of maximum allowable contact voltage (see § 13.11) that will compare with the measured value in order to provide the final positive or negative result of the measurement. Confirm the choice by going back to the initial measurement screen.



7. For **resistivity measurement**, the instrument shows the initial screen as in the figure to the side.

Touch the icon to the right to set the measurement unit and the distance between the test probes. The following screen appears on the display:

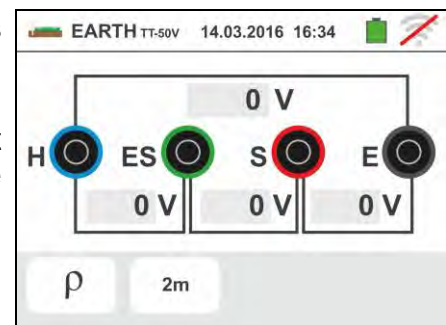

8. Move the slide bar reference on the left to select the measurement unit of the distance between the options: **m** (meters) or **ft** (feet).

Move the slide bar reference on the right to select the distance "d" between the measuring probes choosing between **1m ÷ 10m** (**3ft ÷ 30ft**).

Confirm the choices by going back to the initial measurement screen.

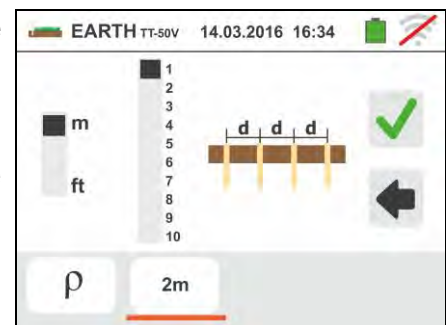

9. Connect the blue, red, green and black cables to the corresponding instrument input terminals H, S, ES, E, then add the alligator clips, if necessary.

10. Extend, if necessary, the blue and red measuring cables on a separate way by means of cables with proper section. Adding any extension does not require calibration and does not affect the measured earth resistance value.

- 11 Drive the auxiliary rods into the ground keeping to the distance instructions provided by the standards (see § 13.12).
- 12 Connect the alligator clips to the auxiliary rods and to the installation under test according to Fig. 27, Fig. 28, Fig. 29 or Fig. 30.

- 13 Press the **GO/STOP** key. During this whole stage, do not disconnect the measuring leads of the instrument from the system under test. The ⌚ symbol is shown on the display for the entire duration of the test.

For **earth resistance measurement in TT/IT systems**, in case of **positive** result, the screen to the side is displayed by the instrument. It contains the value of contact voltage in the secondary display, the value of contact resistance of the voltage probe (R_s) and the value of contact resistance of the current probe (R_h).

Press the **SAVE** button or touch the  icon to save the measurement (see § 7.1).

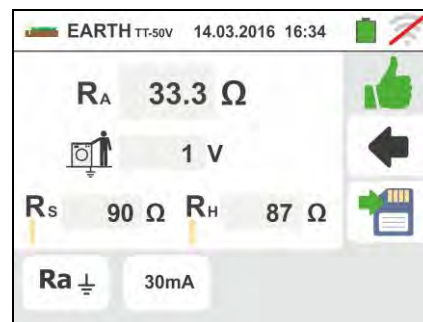

- 14 For **earth resistance measurement in TT systems**, in case of **negative** result (see § 13.7), the screen to the side is displayed by the instrument. It contains the value of contact voltage in the secondary display, the value of contact resistance of the voltage probe (R_s) and the value of contact resistance of the current probe (R_h).

Note the presence of the measurement result highlighted in red.

Press the **SAVE** button or touch the  icon to save the measurement (see § 7.1).

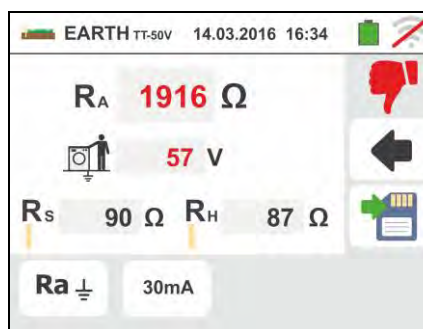

- 15 For **earth resistance measurement in IT systems**, in case of **negative** result (see § 13.8), the screen to the side is displayed by the instrument. It contains the value of contact voltage in the secondary display, the value of contact resistance of the voltage probe (R_s) and the value of contact resistance of the current probe (R_h).

Note the presence of the measurement result highlighted in red.

Press the **SAVE** button or touch the  icon to save the measurement (see § 7.1).

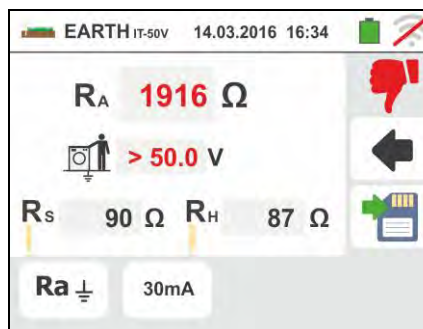

- 16 For **earth resistance measurement in TN systems**, in case of **positive** result (see § 13.11), the screen to the side is displayed by the instrument. It contains the value of contact voltage in the secondary display, the value of contact resistance of the voltage probe (R_s) and the value of contact resistance of the current probe (R_h).



Press the **SAVE** button or touch the  icon to save the measurement (see § 7.1).



- 17 For **earth resistance measurement in TN systems**, in case of **negative** result (see § 13.11), the screen to the side is displayed by the instrument. It contains the value of contact voltage in the secondary display, the value of contact resistance of the voltage probe (R_s) and the value of contact resistance of the current probe (R_h).

Note the presence of the measurement result highlighted in red.



Press the **SAVE** button or touch the  icon to save the measurement (see § 7.1).

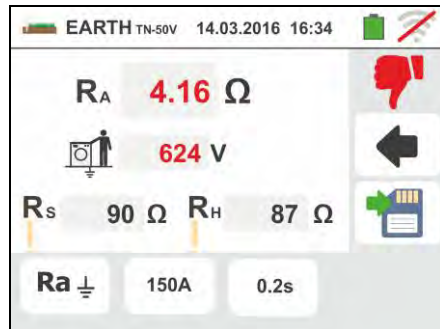

- 18 If the resistance value of R_s or R_h probes is $> 100 * R_{measured}$ the instrument performs the measurement considering an accuracy of 10% of reading and marks the value in red in corripsondence of R_s and/or R_h the screen to the side is displayed

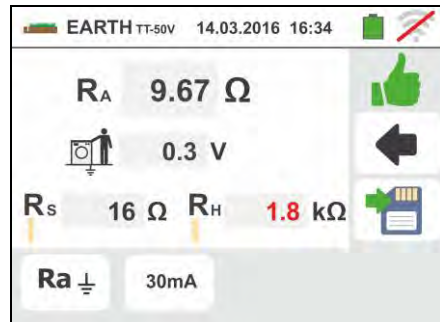

- 19 For **ground resistivity measurement**, the screen to the side is shown by the instrument. It contains the value of " ρ " expressed in Ωm and the " V_n " value of the possible interfering voltage measured by the instrument during the test.



Press the **SAVE** button or touch the  icon to save the measurement (see § 7.1).



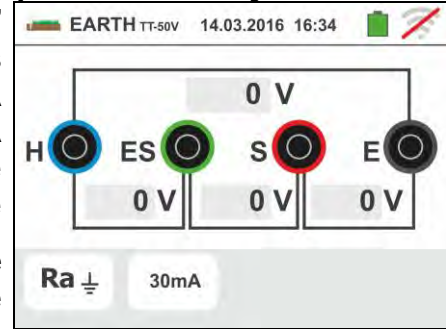

6.7.2. 3-wire or 2-wire earth measure – USA, Extra Europe and Germany countries

1. Select the “USA”, “Extra Europe” or “Germany” reference countries (see § 5.1.2). Select the options “TN”, “TT” (**measurement not available for USA country**) or “IT” (**measurement not available for USA country**), “25 or 50V”, “50Hz or 60Hz” and the reference voltage in the general settings of the instrument (see § 5.1.4). Touch the  icon. The screen to the side (**TT and IT systems**) is shown on the display. The instrument automatically carries out the test in presence of voltage between the inputs (shown on the display) and blocks the test in case of voltage higher than 10V



Touch the first icon in the lower left corner to set the measuring mode. The following screen appears on the display:

2. Move the slide bar reference in the position "**Ra** 
- for the selection of the earth measurement with voltammetric method, in the  position for the resistance measurement with use of optional clamp T2100 (see § 6.7.3) or in the " ρ " position for the measurement of ground resistivity. Confirm the choice by going back to the initial measurement screen.



Touch the second icon in the lower left corner to set the tripping current of the differential switch (**TT and IT systems**). The following screen appears on the display:

3. Move the slide bar reference in the position corresponding to the value of the tripping current of the RCD differential switch as shown in the screen to the side. On the basis of this selection and the value of contact voltage (25V or 50V), the instrument performs the calculation of the limit value of earth resistance (see § 13.11) that will compare with the measured value in order to provide the final positive or negative result of the measurement.



4. For **TN systems**, the instrument shows the initial screen as in the figure to the side.

Touch the second icon to set the limit value of the earth resistance which will be used by the instrument as reference. The following screen appears on the display:

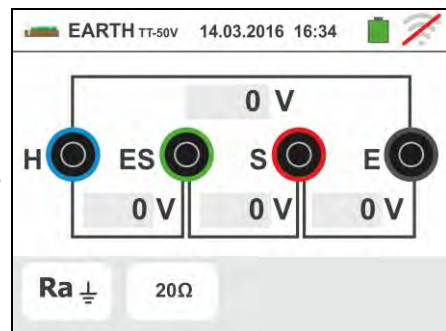

5. Touch the  icon to zero the value in the " Ω " field and use the virtual keyboard to set the value of limit earth resistance between **1 Ω** and **999 Ω** . Confirm the choice by going back to the initial measurement screen.

Connect the instrument to the installation as indicated in the points 9, 10, 11 and 12 of the § 6.7.1)



6. Press the **GO/STOP** key. During this whole stage, do not disconnect the measuring leads of the instrument from the system under test. The  symbol is shown on the display for the entire duration of the test.

For **earth resistance measurement in TT/IT systems**, in case of **positive** result (see § 13.7), the screen to the side is displayed by the instrument. It contains the value of contact voltage in the secondary display, the value of contact resistance of the voltage probe (R_s) and the value of contact resistance of the current probe (R_h).

Press the **SAVE** button or touch the  icon to save the measurement (see § 7.1).

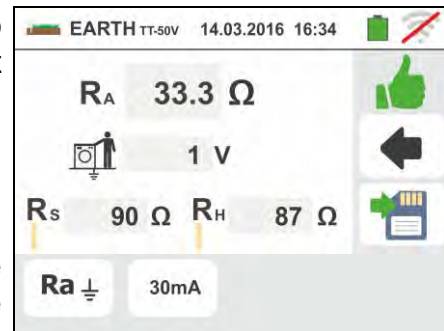

7. For **earth resistance measurement in TT systems**, in case of **negative** result (see § 13.7), the screen to the side is displayed by the instrument. It contains the value of contact voltage in the secondary display, the value of contact resistance of the voltage probe (R_s) and the value of contact resistance of the current probe (R_h).

Note the presence of the measurement result highlighted in red.

Press the **SAVE** button or touch the  icon to save the measurement (see § 7.1).

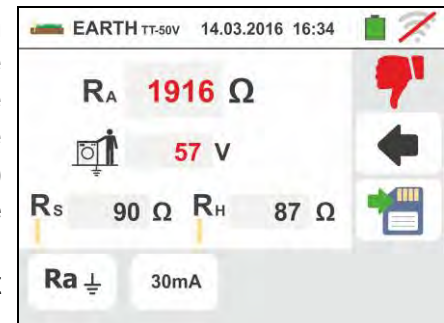

8. For **earth resistance measurement in IT systems**, in case of **negative** result (see § 13.8), the screen to the side is displayed by the instrument. It contains the value of contact voltage in the secondary display, the value of contact resistance of the voltage probe (R_s) and the value of contact resistance of the current probe (R_h).

Note the presence of the measurement result highlighted in red.

Press the **SAVE** button or touch the  icon to save the measurement (see § 7.1).

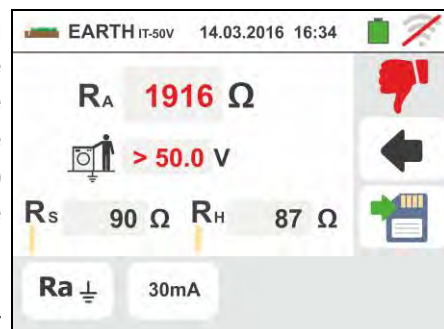

9. For **earth resistance measurement in TN systems**, in case of **positive** result (measured value LOWER than set limit value), the screen to the side is displayed by the instrument. It contains also the value of contact resistance of the voltage probe (R_s) and the value of contact resistance of the current probe (R_h).

Press the **SAVE** button or touch the  icon to save the measurement (see § 7.1).

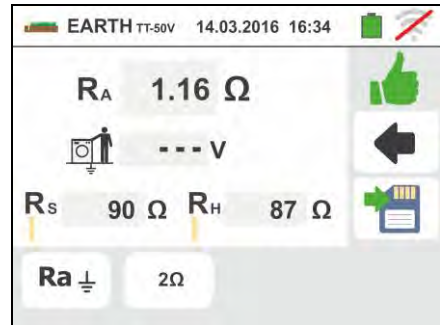

- 10 For **earth resistance measurement in TN systems**, in case of **negative** result (measured value HIGHER than set limit value), the screen to the side is displayed by the instrument. It contains also the value of contact resistance of the voltage probe (R_s) and the value of contact resistance of the current probe (R_h).

Note the presence of the measurement result highlighted in red.

Press the **SAVE** button or touch the  icon to save the measurement (see § 7.1).

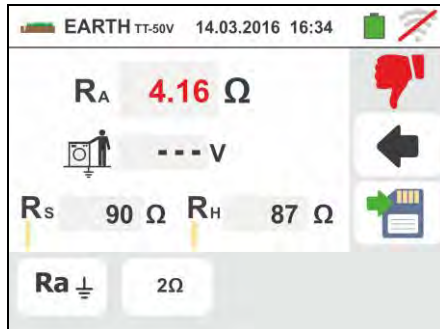

6.7.3. Earth measurement with optional clamp T2100

This measurement allows evaluating the partial resistances of the single earth rods of complex ring networks without disconnecting them and performs the calculation of the corresponding parallel resistance. Please refer to the user manual of clamp T2100 for specific details. The following measurement methods are available:

- Measurement of rod resistance with direct connection of clamp T2100 to the instrument.
- Measurement of rod resistance by means of clamp T2100 used independently and subsequent connection of the clamp to the instrument for data transfer.



CAUTION

The measurement carried out by clamp T2100 can be used to evaluate single rods resistance values within an earth installation without disconnecting the rods, **assuming they do not affect each other** (see Fig. 31).

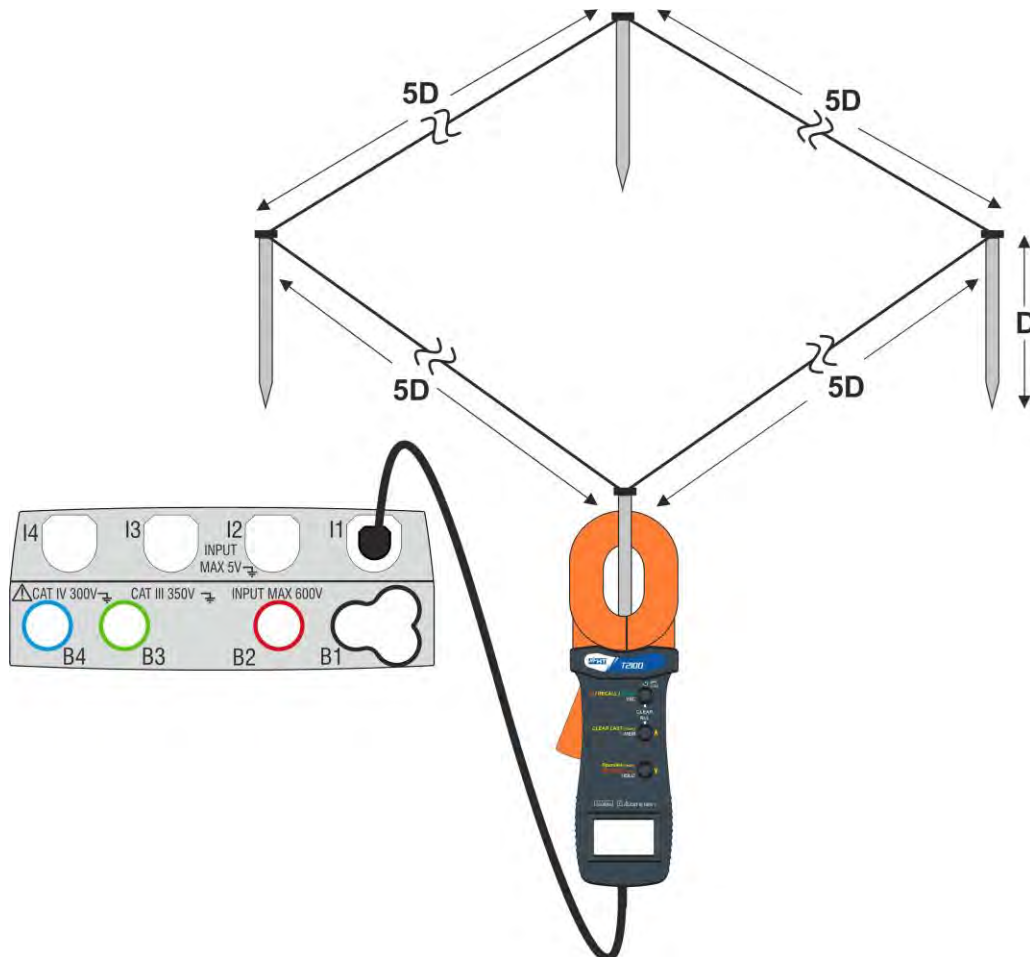
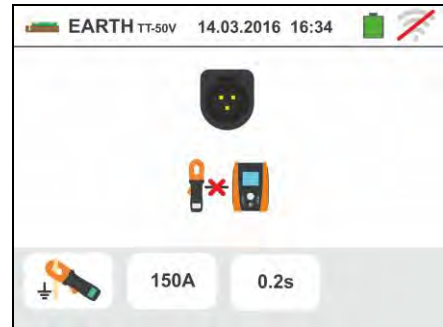

Fig. 31: Resistance measurement of single rods with clamp T2100

1. Select the options "TN, TT or "IT", "25 or 50V", "50Hz or 60Hz" and the reference voltage in the general settings of the instrument (see § 5.1.4). Touch the icon, touch the first icon in the lower left corner and set the measurement mode (see § 6.7.1 point 2). The following screen appears on the display. The icon indicates that the clamp T2100 is not connected to the instrument or is not in "RS232" mode. Configure the same settings on the protection parameters depending on the type of system (TT, TN or IT) (see § 6.7.1 points 3, 4, 5, 6 or see § 6.7.2 points 3, 4, 5)



2. Connect the clamp T2100 by inserting the connector into input **In1** of the instrument. Turn the clamp on and put it in "RS232" mode (see the user manual of the clamp). The symbol appears on the display of the clamp. **In these conditions, the instrument-clamp group is ready to perform the measurements.** The following screen is shown on the display by the instrument.

3. The meaning of the symbols is the following:

- → This icon indicate the correct serial connection of the clamp to the instrument
- → Touch this icon to zero all the values of the measured probes and the correspondent parallel resistance
- → Touch this icon to add a rod to the measurement. The "N" parameter increases by one unit.
- **R_A** → indicates the calculation of the parallel of resistances for each measurement performed on each rod.
- → This indicates the value of contact voltage resulting from the measurement.
- **N** → indicates the number of rods in the measure.
- **R** → indicates the resistance value of the rod currently measured.
- → It allows downloading on the instrument the memory contents of clamp T2100 in order to obtain the final result of the measurement.

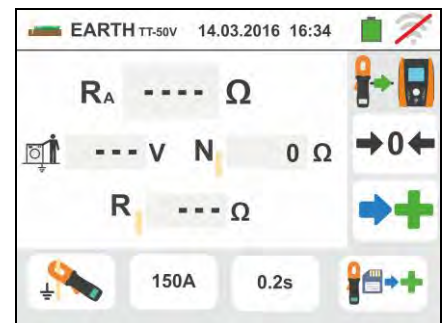



Rods resistance measurement with clamp T2100 connected to the instrument

4. Connect the clamp to the first rod of the earth network considered as shown in Fig. 31. Note the value of the resistance in the **R** field and press the icon to insert this value in the calculation of parallel resistance and increase the **N** parameter by one unit (**N** =1)

5. After the insertion of the value of the first rod it will be not possible to transfer the eventually measurements saved inside the T2100 by means the  key. Perform the same procedure for each rod of the network in question. At the end of the measurements, press the **GO/STOP** key on the instrument. The following screen appears on the display

6. The **R_A** field shows the value of the resistances in parallel performed on each rod of the earth network considered. This value is compared with the maximum limit value calculated by the instrument according to the selections made on the parameters of the protections.

In case of positive result (see § 13.7 and § 13.11), the instrument shows the  symbol and it is also possible to scroll through the values of partial resistances by touching the keys  and 

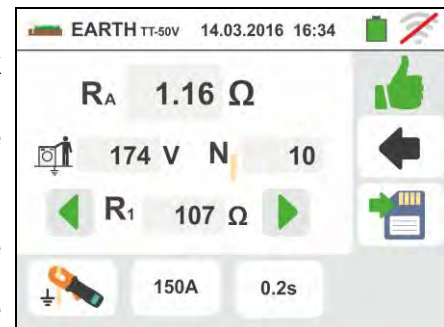

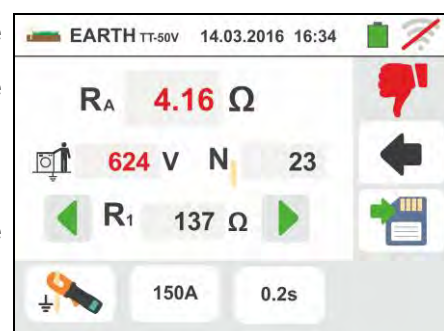

Press the **SAVE** button or touch the  icon to save the measurement (see § 7.1).

7. In case of negative result (see § 13.7 and § 13.11), the instrument shows the  symbol and the result value appears in red like in the screen to the side.



Press the **SAVE** button or touch the  icon to save the measurement (see § 7.1).

Rods resistance measurement with clamp T2100 used in an independent way

1. Turn the clamp T2100 on, perform the measurements on each rod of the earth network considered by saving the results in its internal memory (see the user manual of clamp T2100).
2. At the end of the measurement, connect the clamp T2100 to the instrument by inserting the connector into input **In1** and put it in "RS232" mode (see the user manual of clamp T2100). The 232^{rs} symbol appears on the display of the clamp.
3. Touch the  icon. Any data stored in the memory of the clamp is downloaded in the instrument and slides in sequence on the display. At the end of the operation, the  symbol disappears from the display
4. With the clamp connected to the instrument is possible to perform and add other measurements according to the actions described in the previous point 4
5. Press the **GO/STOP** key on the instrument and observe the positive or negative results of the measurement as shown in points 6 and 7 of the previous mode.

6.7.4. Anomalous situations in 3-wire and 2-wire earth measurements

1. When starting a measurement, if the instrument detects an interfering voltage higher than 10V at the volt and ampere circuits input, it does not perform the test and displays the screen to the side.



2. When starting a measurement, the instrument checks the continuity of measuring cables. **If the voltmetric circuit (red cable S and green cable ES) is interrupted or its resistance value is too high**, the instrument displays a screen similar to the one on the side.

Check that the terminals are properly connected and that the rod connected to terminal S is not driven into a pebbly or scarcely conductive ground. In this latter case, pour water around the rod to decrease its resistance value (see § 13.12)

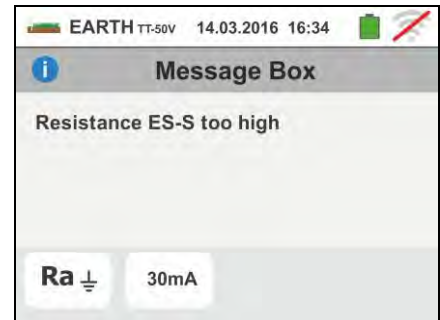

3. When starting a measurement, the instrument checks the continuity of measuring cables. **If the ampermetric circuit (blue cable H and black cable E) is interrupted or its resistance value is too high**, the instrument displays a screen similar to the one on the side.

Check that the terminals are properly connected and that the rod connected to terminal H is not driven into a pebbly or scarcely conductive ground. In this latter case, pour water around the rod to decrease its resistance value (see § 13.12)

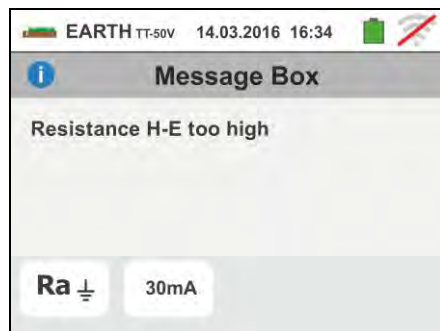

4. When starting a measurement, the instrument checks the situation of B2 (S) and B3 (ES) inputs. In case of reverse of conductors on the installation it blocks the test and the message is shown



6.8. AUX: MEASURE AND RECORDING OF AMBIENT PARAMETERS

By means of external transducers, this function allows measuring and recording the following environmental parameters:

- °C air temperature in °C by means of thermometric transducer
- °F air temperature in °F by means of thermometric transducer
- Lux(20)** illuminance by means of luxmetric transducer with a 20Lux capacity
- Lux(2k)** illuminance by means of luxmetric transducer with a 2kLux capacity
- Lux(20k)** illuminance by means of luxmetric transducer with a 20kLux capacity
- RH%** air relative humidity by means of humidity transducer
- mV** input DC voltage (without applying any transduction constant)

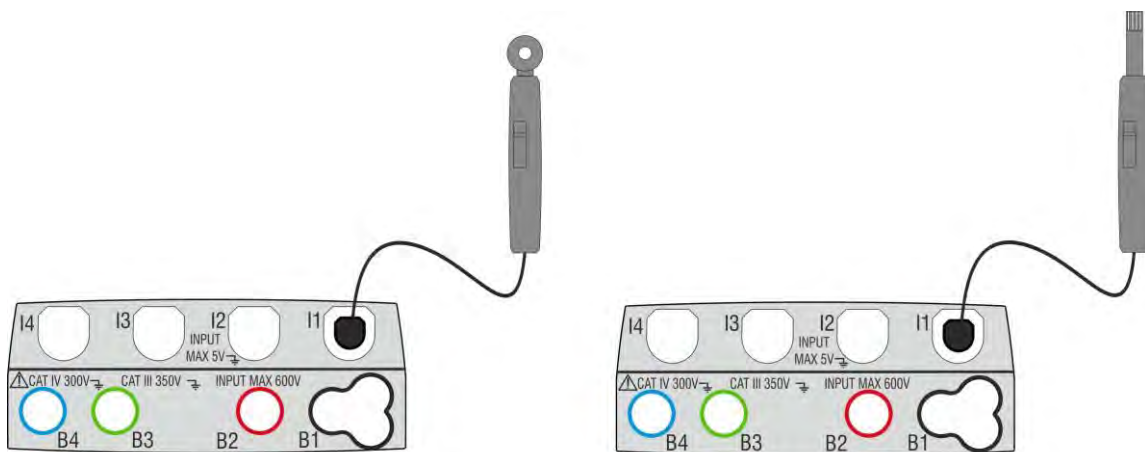
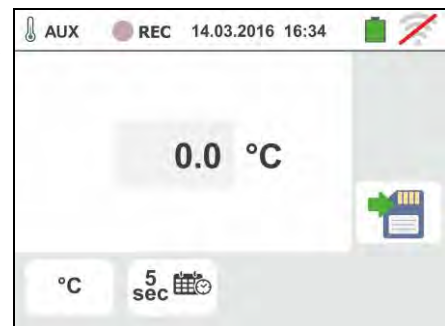

Fig. 32: Measurement of environmental parameters through external probes

1 Touch the icon and then the icon. The screen to the side appears on the display.

Touch the icon to set the type of measurement. The following screen appears on the display:



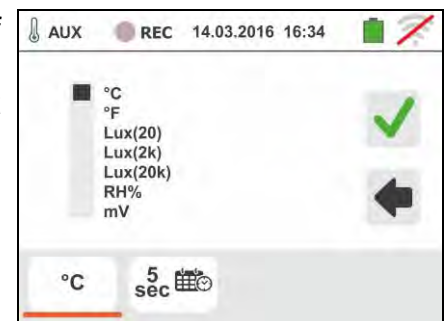

2 Move the slide bar reference to select the type of measurement among the options: °C (temperature in Celsius degrees), °F (temperature in Fahrenheit degrees), **Lux(20)** (illuminance with 20Lux capacity), **Lux(2k)** (illuminance with 2kLux capacity), **Lux(20k)** (illuminance with 20kLux capacity), **,%RH** (relative humidity), **mV** (measurement of DC voltage up to 1V)

Touch the icon to set the parameters of recording. The followed screen is shown





3 Move the left slide bar cursor in order to select the aggregation time (see § 13.16) among the options: **2s, 5s, 10s, 30s, 1min, 2min, 5min, 10min, 15min, 30min**

Move the central slide bar cursor (“GO” symbol) to the positions:

-  **Manual** start of recording by pressing the **GO/STOP** key (at the next minute after the pressure of key)
-  → **Automatic** start of recording at the date/time set by the user (after a preliminary pressure of **GO/STOP** key in order to set the instrument in stand-by mode). **Touch the corresponding field to set the date/time** in the “MM:DD:YY HH:MM” format and confirm

Move the right slide bar cursor (“STOP” symbol) in the positions:

-  **Manual** stop of recording by pressing the **GO/STOP** key
-  → **Automatic** stop of recording at the date/time set by the user. **Touch the corresponding field to set the date/time** in the “MM:DD:YY HH:MM” format and confirm

4 Insert in the auxiliary **I1** input the transducer necessary for the desired measurement as shown in Fig. 32

5 The measured value appears on the display in real time as shown in the screen to the side.

Press the **SAVE** button or touch the  icon to save the measurement (see § 7.1).

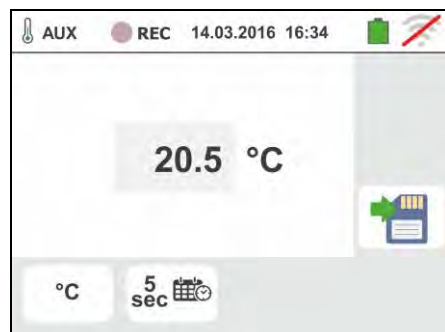
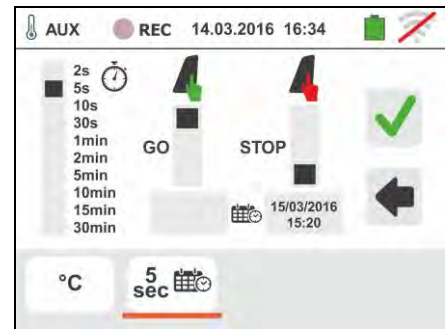

6. Press the **GO/STOP** key to start recording. The instrument enters stand-by mode (waiting for the next minute or the set date/time) and the “” symbol is displayed as shown in the screen to the side.

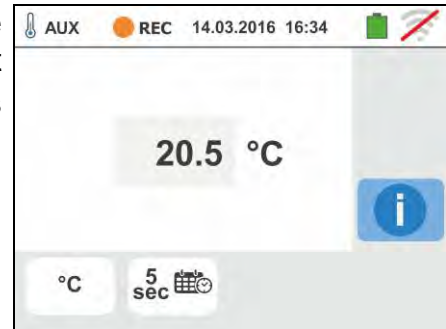

7. With recording running, the “” symbol is displayed as shown in the screen to the side.

Touch the “” icon to read in real time the information about on-going recording. The following screen appears on the display

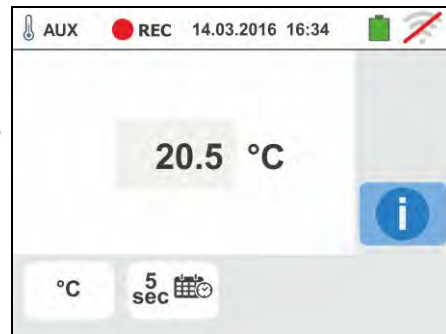

8. The screen contains:

- The number of recording
- The date/time of recording start (if automatic)
- The date/time of recording stop (if automatic)
- The aggregation time set
- The number of aggregation intervals recorded
- The residual memory capacity expressed in DD-HH-MM



9. Press **GO/STOP** key to stop recording; the instrument automatically saves the result in its memory (see § 7.1.3). The message to the side is shown.

Confirm by touching the “” icon or touch the “” icon to go back to the previous screen



6.9. $\Delta V\%$: VOLTAGE DROP OF MAIN LINES

This feature allows to evaluating the percentage value of voltage drop between two points of a main line in which a protection device is installed and comparing this value to possible limit value specified by guidelines. The following modes are available:

- L-N** Measurement of Phase to Neutral line impedance. The test can be performed also with high resolution ($0.1\text{m}\Omega$) with optional accessory IMP57
- L-L** Measurement of Phase to Phase line impedance. The test can be performed also with high resolution ($0.1\text{m}\Omega$) with optional accessory IMP57



CAUTION

- The instrument can be used for measurements on installations with overvoltage category CAT IV 300V to earth and max 600V between inputs. Do not connect the instrument on installations with voltage exceeding the limits indicated in this manual. Exceeding these limits could cause electrical shock to the user and damage to the instrument.
- Always connect the measuring cables to the instrument and to the alligator clips with the accessories disconnected from the system
- We recommend holding the alligator clip respecting the safety area created by the hand protection (see § 4.2).



CAUTION

The measurement of line impedance or fault loop impedance involves the circulation of a maximum current according to the technical specifications of the instrument (see § 11.1). This could cause the tripping of possible magnetothermal protections at lower tripping currents.

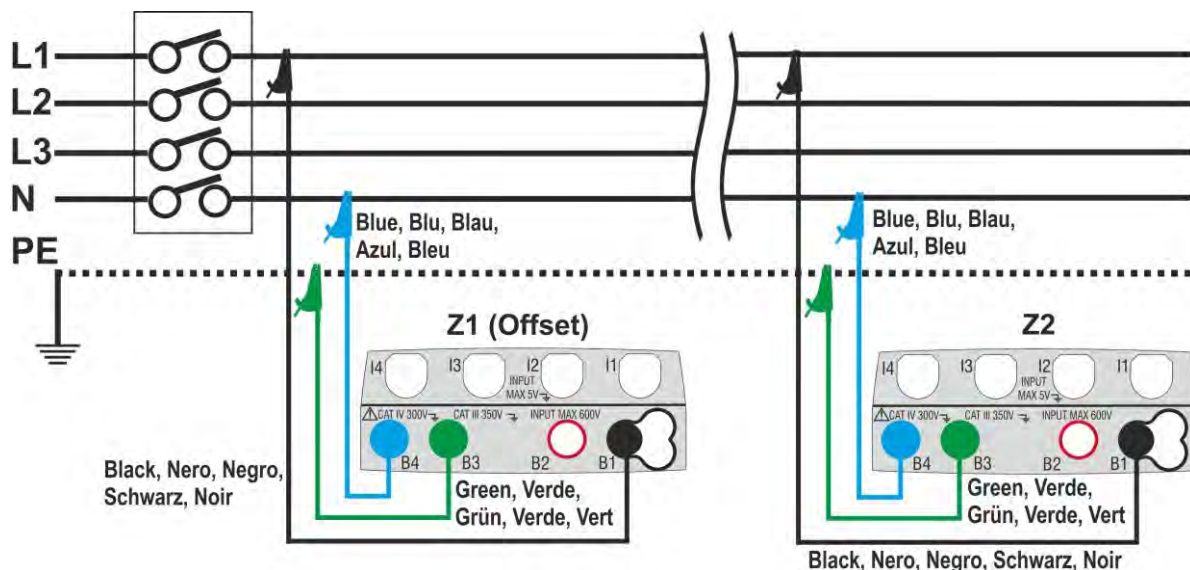

Fig. 33: Connection of the instrument for L-N mode voltage drop measurement

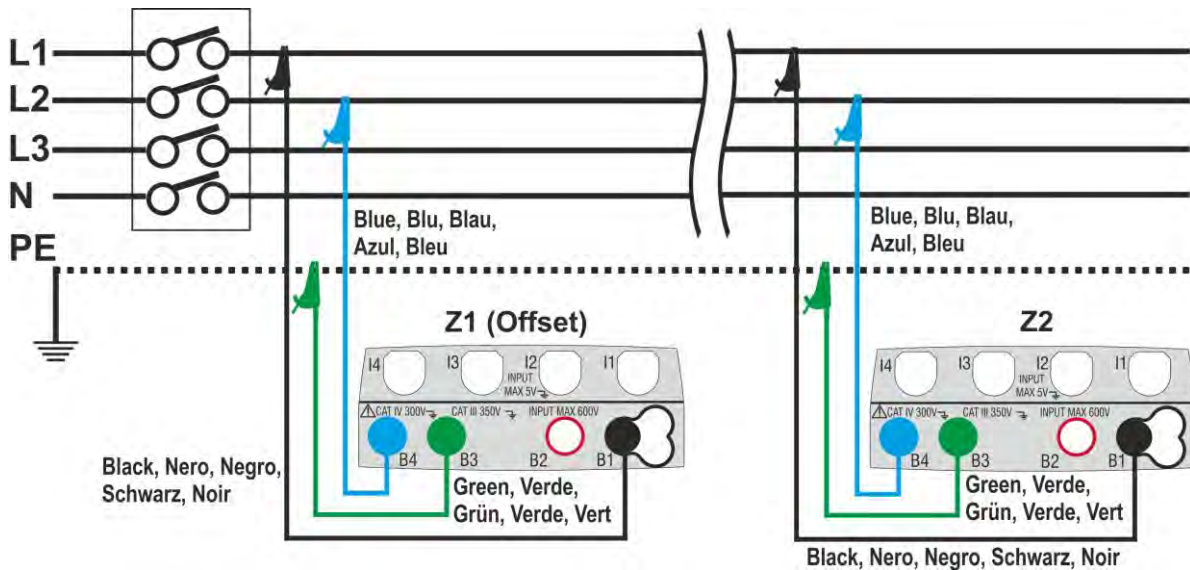
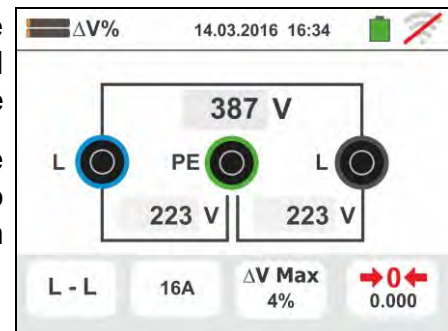
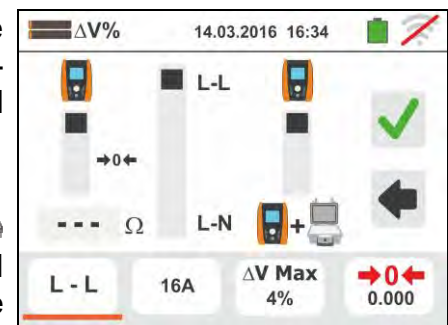

Fig. 34: Connection of the instrument for L-L mode voltage drop measurement

1. Select the option “50Hz or 60Hz” and the reference Phase-Neutral or Phase-Phase voltage in the general settings of the instrument (see § 5.1.4). Touch the icon and then the icon. The screen to the side appears on the display. Touch the lower left icon to set the type of measurement. The following screen appears on the display



2. Move the second slide bar reference and select the type of measurement between the options: **L-L** (Phase-Phase measurement) or **L-N** (Phase-Neutral measurement).



Move the third slide bar reference and select the icon to carry out measurement with the optional accessory IMP57 (see § 6.4.10). Move the first slide bar reference thus selecting options:

- → Impedance measurement performed with the instrument only. With this option the icon “0 \leftarrow ” is shown on the display
- → Possibility for the operator to manually set the **Offset Z1** impedance without carrying out the first measurement. With this option the icon “0 \leftarrow ” is shown on the display and the following screen appears on the display

3. Touch the icon to zero the value in the “ Ω ” field and use the virtual keyboard to set the value of the **Offset Z1** impedance within the range **0.000 Ω** to **9999 Ω** . Confirm the selection and go back to the previous screen. Touch the second lower icon and set the value of the rated current of the protection device on the main line being tested. The following screen appears on the display

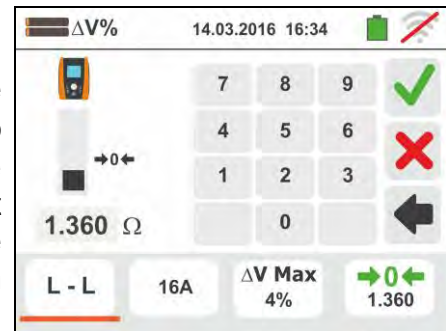

4. Touch the icon to zero the value in “A” field and use the virtual keyboard to set the value of rated current of protection device in the range **1A** to **9999A**. Confirm selection and go back to the previous screen.

Touch the third lower icon and set the maximum allowed limit value of voltage drop ($\Delta V\%$) for the main line being tested. The following screen appears on the display.



5. Touch the icon to zero the value in the “%” field and use the virtual keyboard to set the value of $\Delta V\%$ in the range **1%** to **99%**.

Confirm the selection and go back to the previous screen



6. Go to step no. 9 in case the value of Z1 (Offset) has been set manually. **In case of the value of Z1 (Offset) has NOT been manually set** connect the instrument to the initial point of the main line being tested (typically downstream to a protection device) according to Fig. 33 or Fig. 34 in order to carry out the first **Z1 (Offset)** impedance measurement. In this case the instrument will measure the impedance upstream of the initial point of the main line being tested taking it as start reference. The following screen (referred to L-L measurement) appears on the display

7. Touch the icon to start the first **Z1 (Offset)** impedance measurement. The symbol appears on the display during measurement. At the end of measurement the following screen appears on the display

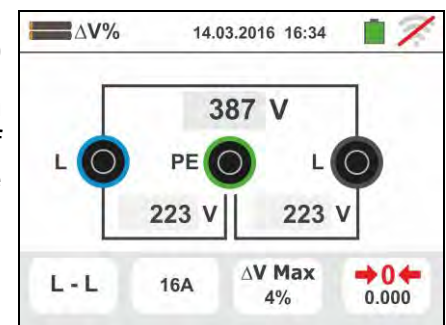

8. The value of **Z1 (Offset)** impedance is shown on the display and is automatically included on the lower right icon, together with the “→0←” symbol to indicate the instantaneous saving of the value

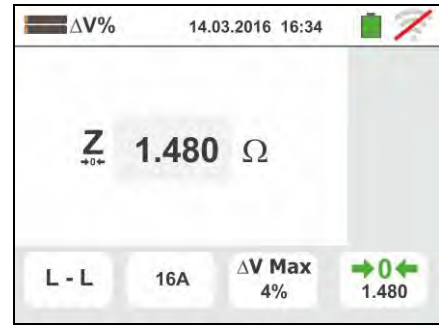

9. Connect the instrument to the final point of the main line being tested according to Fig. 33 or Fig. 34 in order to measure the **Z2** impedance at the end of line. The screen to the side is displayed. Note the previously measured Z1 (Offset) value displayed

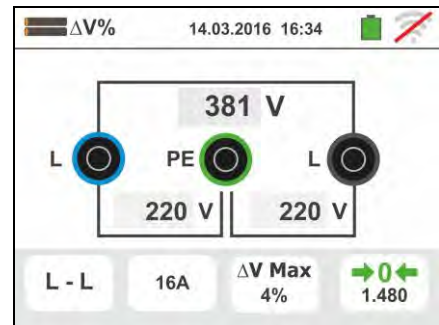

- 10 Press the **GO/STOP** key on the instrument to measure the Z2 impedance and complete the $\Delta V\%$ voltage drop measurement. During this whole stage, do not disconnect the measuring leads of the instrument from the system being tested



In case of positive result (**maximum percentage value of calculated voltage drop according to § 13.11 < set limit value**), the screen to the side is displayed by the instrument, which contains the value of the **Z2** end of line impedance together the **Z1 (Offset)** value.

Press the **SAVE** button or touch the  icon to save the measurement (see § 7.1)

- 11 In case of negative result (**maximum percentage value of calculated voltage drop according to § 13.11 > set limit value**), the screen to the side is displayed by the instrument, which contains the value of the **Z2** end of line impedance together with the **Z1 (Offset)** value. Press the **SAVE** button or touch the

 icon to save measurement (see § 7.1)



6.9.1. Anomalous situations

1. If the instrument detects an L-N or L-PE voltage higher than the maximum limit (265V), it does not carry out the test and displays a screen like the one to the side. Check the connection of measuring cables

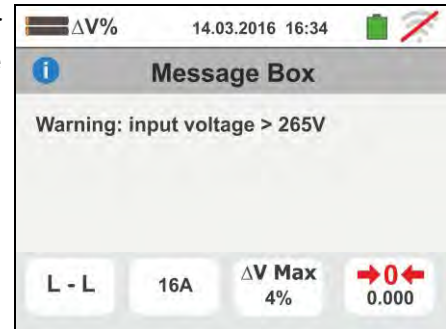

2. If the instrument detects an L-N or L-PE voltage lower than the minimum limit (100V), it does not carry out the test and displays a screen like the one to the side. Check that the system being tested is supplied

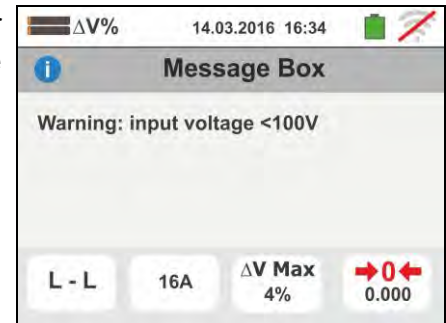

3. If the instrument detects the absence of the signal to terminal B1 (phase conductor), it provides the warning screen shown to the side and blocks the execution of the tests

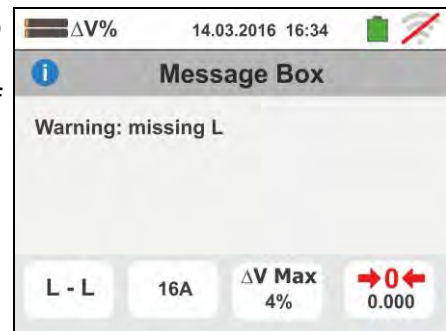

4. If the instrument detects the absence of the signal to terminal B4 (neutral conductor), it provides the warning screen shown to the side and blocks the execution of the tests

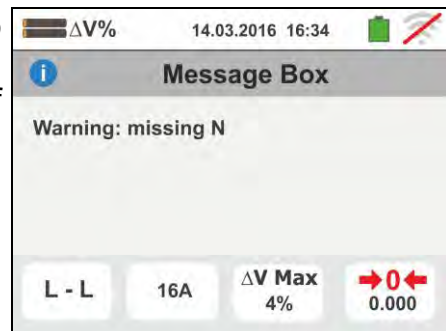

5. If the instrument detects the absence of the signal to terminal B3 (PE conductor), it provides the warning screen shown to the side and blocks the execution of the tests.

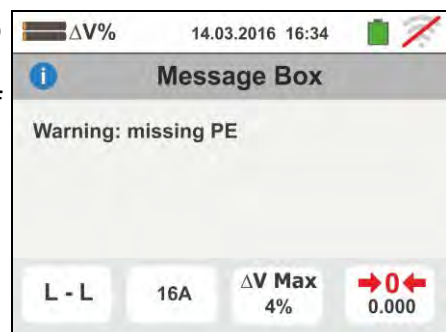

6. If the instrument detects that the phase and neutral leads are inverted, it does not carry out the test and a screen similar to the one reported to the side is displayed. Rotate the shuko plug or check the connection of measuring cables

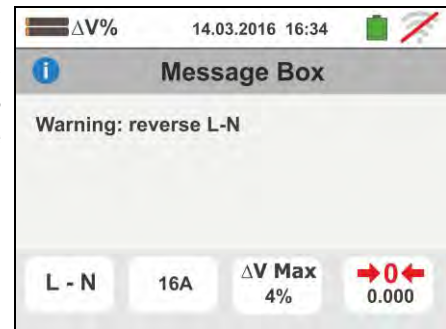

7. If the instrument detects that the phase and PE leads are inverted, it does not carry out the test and a screen similar to the one reported to the side is displayed. Check the connection of measuring cables

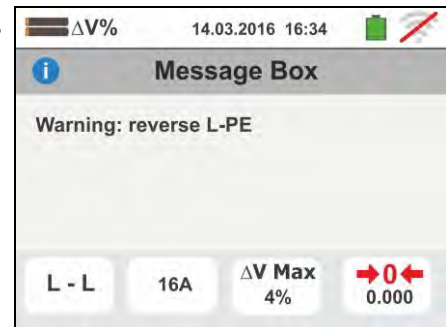

8. If the instrument detects a danger voltage on PE conductor, it does not carry out the test and displays a screen like the one to the side. This message can also appear in case of an insufficient pressure of the **GO/STOP** key

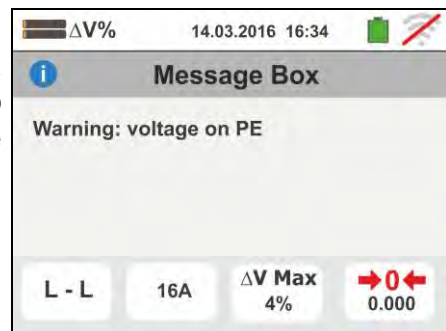

9. If the instrument detects a voltage $V_N-PE > 50V$ (or $>25V$ depending on the selection), it does not carry out the test and displays a screen like the one to the side

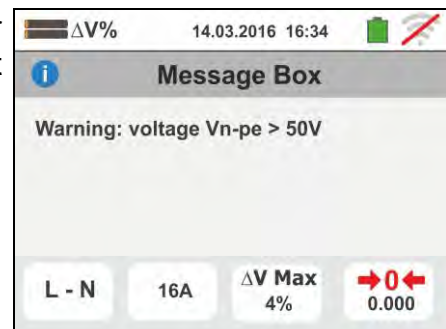

10. If during the measurement the instrument detects an end of line impedance value lower than the initial line impedance value it does not carry out the test and a screen similar to the one reported to the side is displayed. Check the status of the main line being tested

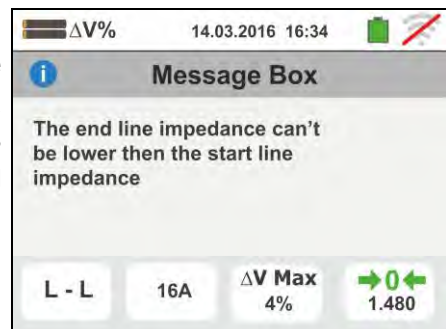

6.10. PQA: MEASUREMENT AND RECORDING OF MAIN PARAMETERS

In this section the instrument allows the below operations:

- Real-time display of numeric values of any electrical parameters of a single-phase and three-phase 3-wire or 4-wire system, harmonic analysis of voltages and currents up to 49th order, power/energies and power peaks absorbed/generated
- Real-time display of any input signal waveform, histogram graphics of harmonics analysis, vector diagrams of mutual angles between voltages and currents and voltage unbalances
- Recording (by pressing the **GO/STOP** key) of TRMS values of voltages, voltage anomalies (sags, swells) with 20ms resolution, currents, corresponding harmonics, active, reactive and apparent powers, power factors and cosphi, active, reactive and apparent energies. **It will be possible to analyze the recorded data ONLY by transferring them onto a PC**

Saving (by pressing the **SAVE** key) of an “Instant” sampling of instantaneous values of any parameters present at instrument input in the instrument’s memory.



CAUTION

- The instrument can be used for measurements on installations with overvoltage category CAT IV 300V to earth and max 600V between inputs. Do not connect the instrument on installations with voltage exceeding the limits indicated in this manual. Exceeding these limits could cause electrical shock to the user and damage to the instrument.
- Always connect the measuring cables to the instrument and to the alligator clips with the accessories disconnected from the system
- We recommend holding the alligator clip respecting the safety area created by the hand protection (see § 4.2).

6.10.1. Connections types

The following types of electric systems can be selected in the instrument:

- Three-phase system **3φ-4WIRES** (three-phase + neutral + PE)
- Three-phase system **3φ-3WIRES** (three-phase without neutral + PE)
- Three-phase system **3φ-ARON** (three-phase + PE)
- Single-phase system **1φ-2WIRES** (phase + neutral)
- Three-phase system 4-wires **3φ-High Leg** – for USA country
- Two-phase system 3-wires **3φ-Y Open** – for USA country
- Three-phase system 3-wires **3φ-Δ Open** – for USA country
- Two-phase system 3-wires **3φ-2EI. ½** – for USA country
- Two-phase system 3-wires **1φ- CentrePoint** – for USA country

Below, the connection schemes corresponding to the above-described situations are reported:

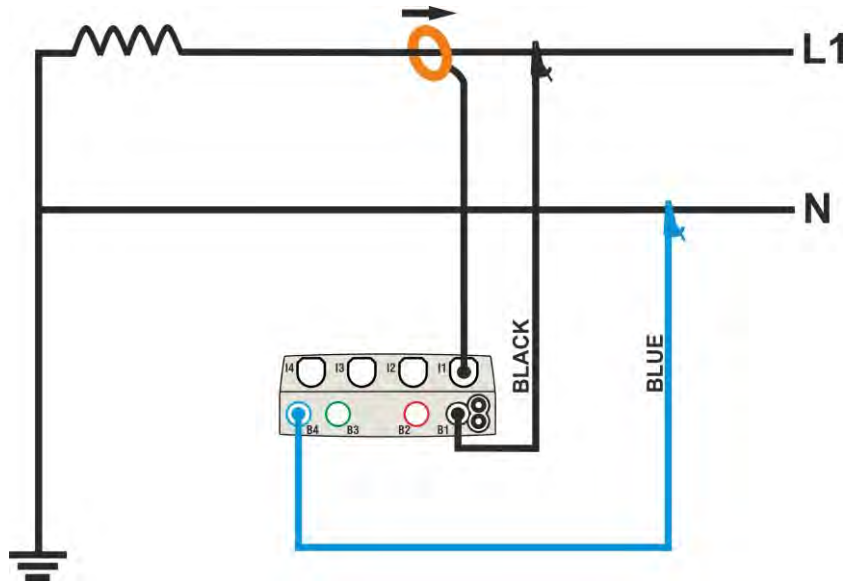

Fig. 35: Connection for measurement on single-phase **1 ϕ -2WIRES**

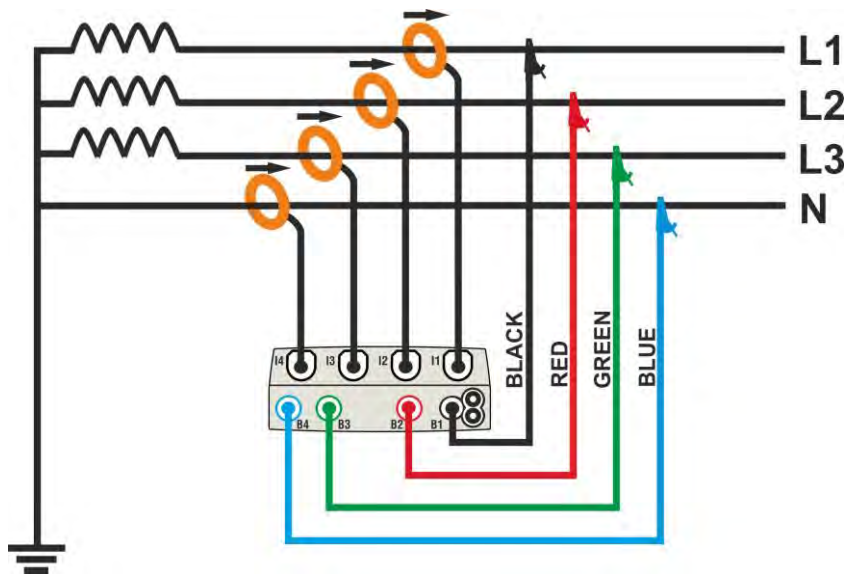

Fig. 36: Connection for measurement on Three-phase system **3 ϕ -4WIRES**

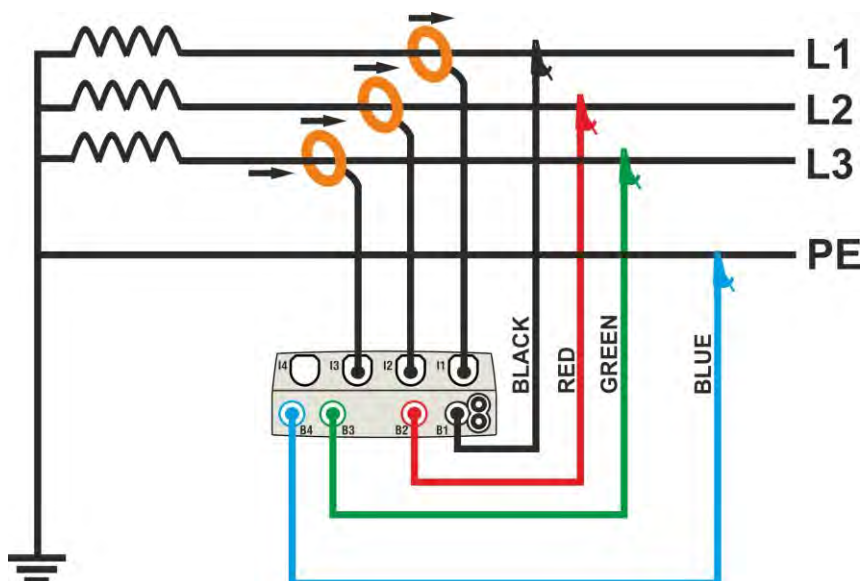

Fig. 37: Connection for measurement on Three-phase system **3 ϕ -3WIRES**

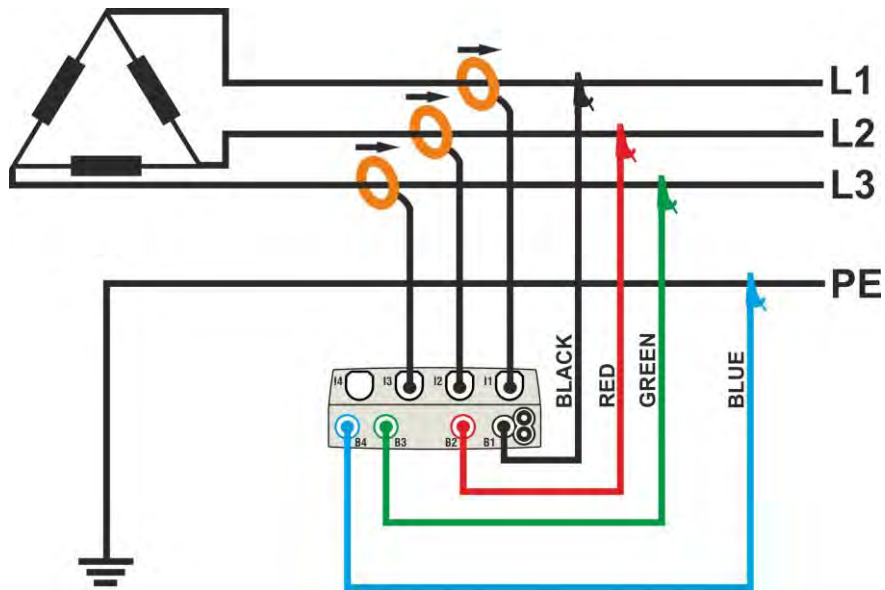

Fig. 38: Connection for measurement on Three-phase system 3ϕ -ARON

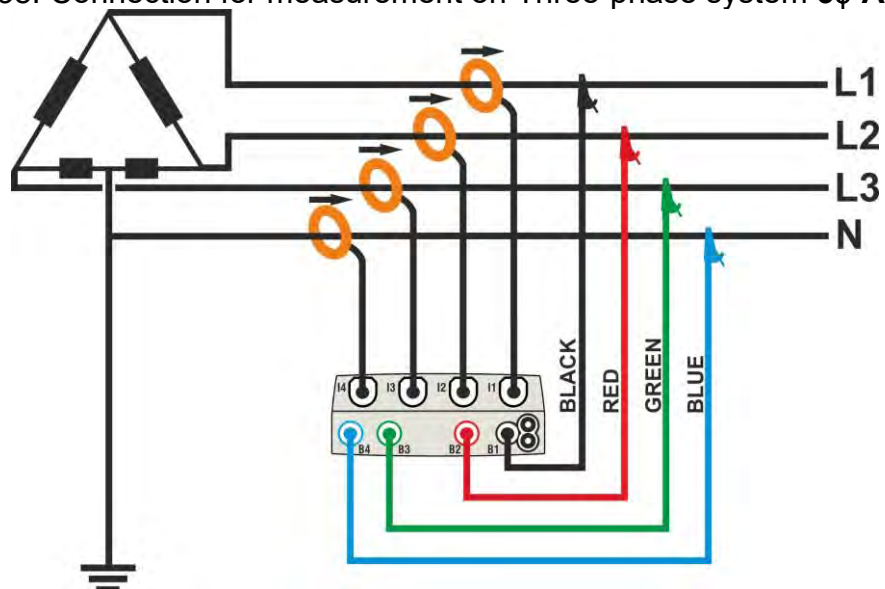

Fig. 39: Connection for measurement on Three-phase system 4-wires 3ϕ -High Leg

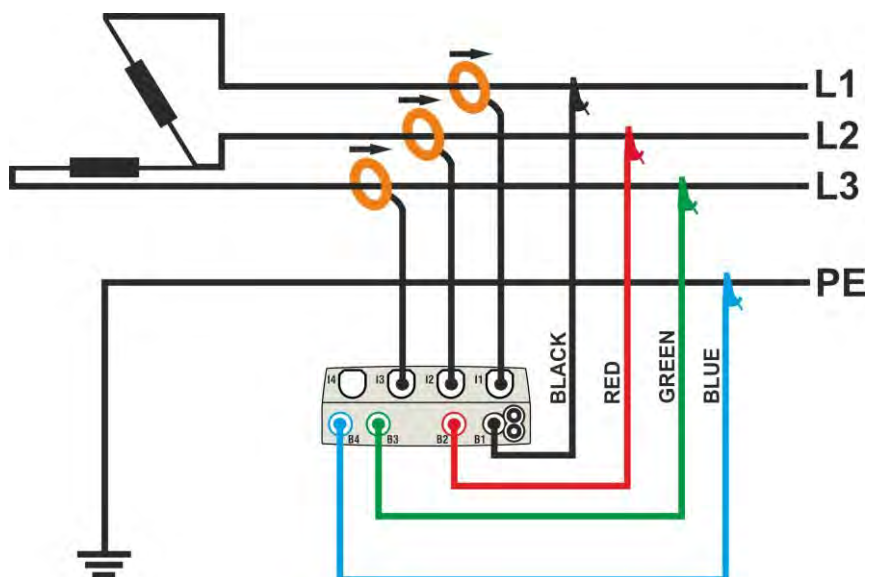

Fig. 40: Connection for measurement on Three-phase system 3-wires 3ϕ - Δ Open

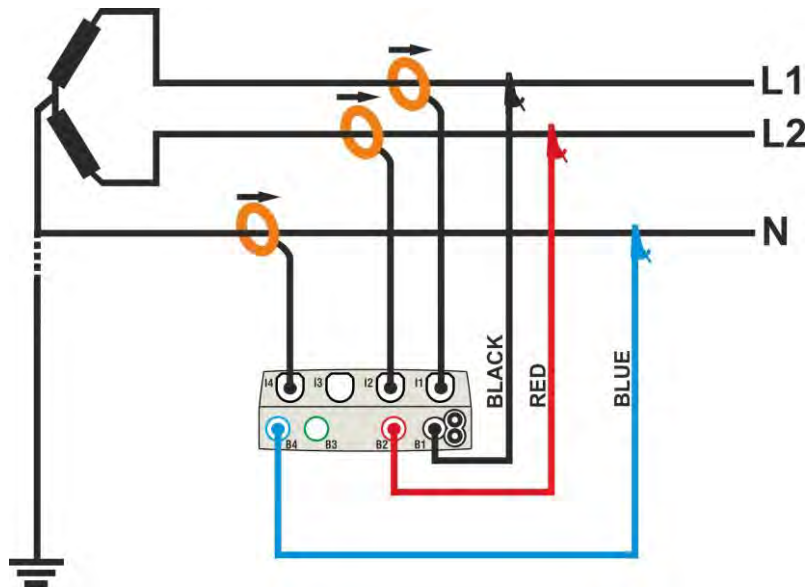

Fig. 41: Connection for measurement on Two-phase system 3-wires **3 ϕ -Y Open**

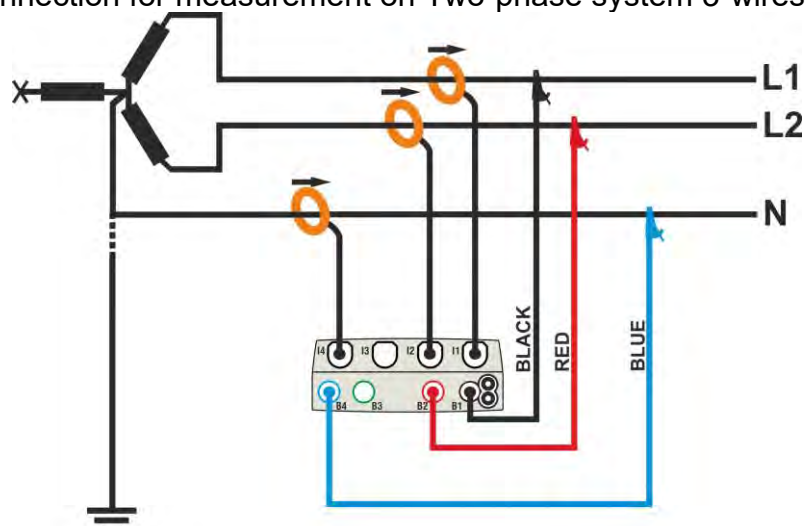

Fig. 42: Connection for measurement on Two-phase system 3-wires **3 ϕ -2EI. 1/2**

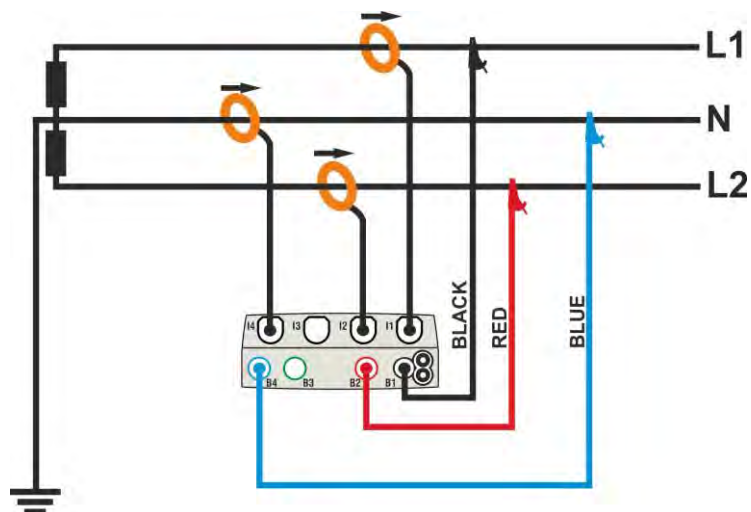

Fig. 43: Connection for measurement on Two-phase system 3-wires **1 ϕ -CentrePoint**

6.10.2. General settings

1. Touch the icon and then the icon. The display shows the screen on the right.

Touch the icon in order to set:

- The type of connection
- The nominal reference voltage and the percentage of positive and negative thresholds for the detection of voltage anomalies
- The ratio of possible VT transformers presents on the installations
- The type and the full scale of transducers clamps used for phase and neutral currents
- The aggregation time and the type of recording start/stop
- The type of possible pre-set configuration

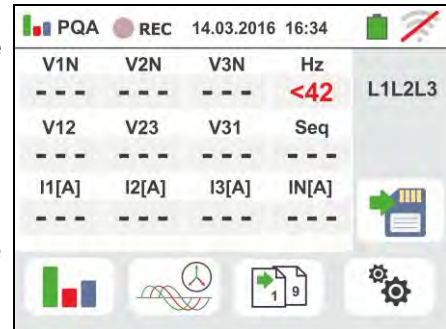

The display shows the following screen

2. Touch the interactive scheme to select the type of connection among the possible situations of § 6.10.1. Note the description in the bottom part of the display.

Touch the or icon keys in order to set the nominal value **V** of the phase-neutral voltage (single-phase or three-phase 4-wire systems) for the detection of voltage anomalies (sags, swells) within the range: **12V ÷ 600V**. Press and hold the keys for a quick selection of value.

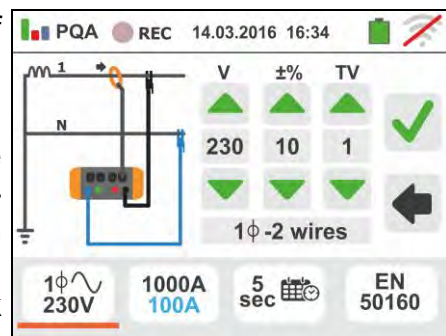



Touch the or icon keys in order to set the $\pm\%$ percentage of positive (sags detection) and negative (swell detection) thresholds with respect to the nominal voltage within the range: **3% ÷ 30%**. Press and hold the keys for a quick selection of values



Touch the or icon keys in order to set the ratio of possible VT transformers presents on the installations within the range: **60 ÷ 3000**. Press and hold the keys for a quick selection of values. **With no VT on the installation (direct connection) the value of this parameter must be always 1**

Touch the icon in order to set the type and the full scale of the used transducer clamps. The display shows the following screen

3. Move the slide bar cursor in order to select the type of clamp for phase current and neutral current measurement (marked in blue color), considering that the clamps can be of different types, between the options:

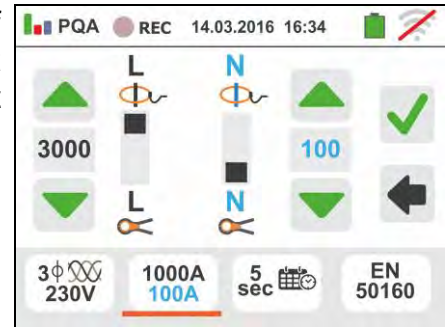
-  → Flexible transducer clamp type (FLEX)
-  → Standard rigid clamp (STD)





Touch the  or  icon keys in order to set the full scale value of the clamps selected for phase and neutral current (marked in blue color) between the options: **300A** or **3000A** (FLEX clamp), range: **1A ÷ 3000A** (STD clamp). Press and hold the keys for a quick selection of values

Touch the  icon to set the parameters of recording. The following screen is shown



4. Move the left slide bar cursor in order to select the aggregation time (see § 13.16) among the options: **2s, 5s, 10s, 30s, 1min, 2min, 5min, 10min, 15min, 30min**

Move the central slide bar cursor (“GO” symbol) to the positions:

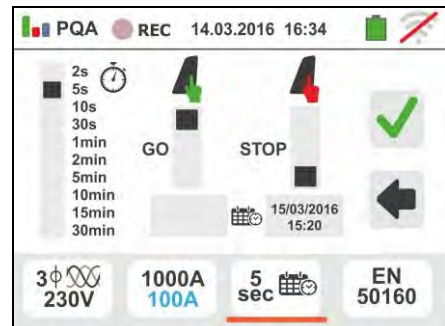
-  →  **Manual** start of recording by pressing the **GO/STOP** key (at the next minute after the pressure of key)
-  → **Automatic** start of recording at the date/time set by the user (after a preliminary pressure of **GO/STOP** key in order to set the instrument in stand-by mode). **Touch the corresponding field to set the date/time** in the “MM:DD:YY HH:MM” format and confirm





Move the right slide bar cursor (“STOP” symbol) in the positions:

-  →  **Manual** stop of recording by pressing the **GO/STOP** key
-  → **Automatic** stop of recording at the date/time set by the user. **Touch the corresponding field to set the date/time** in the “MM:DD:YY HH:MM” format and confirm

5. Touch the  icon in order to select the pre-set configuration (see § 13.17) among those made available by the instrument. A screen like the one to the side is shown. The following options can be selectable:



- **EN50160** → Automatic setting of internal parameters through the instrument in compliance with voltage quality network requirements of guideline EN50160
- **kWh** → Automatic setting of internal parameters through the instrument for the analysis of power/energy problems
- **HARM** → Automatic setting of internal parameters by the instrument for voltage/current harmonic analysis
- **DEFAULT** → Automatic setting of all recording parameters

Confirm each setting by touching the  icon or touch the  icon to go back to main screen

6. Insert the connectors of the test cables into the **B1, B2, B3, B4** input terminals for voltage measurements depending on the selected connection type. Insert the remaining free end of the cables into the corresponding crocodiles or tips. Connect crocodiles or test leads to phase L1, L2, L3 and N according to the images in § 6.10.1. Connect the clamps to **I1, I2, I3** and **I4** inputs and to the phase conductors according to the images in § 6.10.1. The arrow on the clamp must point in the direction in which the current normally flows from the generator to the load

6.10.3. Display of measurements

7. The screen like the one to the side shows the numerical real-time values of electric parameters, referred to a three-phase 4-wire system. For the meaning of the parameters, please refer to § 13.15

V1N	V2N	V3N	Hz	L1L2L3
230.0	230.3	230.1	50.0	
V12	V23	V31	Seq	
401.0	400.0	399.0	123	
I1[A]	I2[A]	I3[A]	IN[A]	
235.7	242.6	240.5	52.5	

Touch the  icon to show the pages (the number of which depends on the type of selected connections) of the TRMS values relevant to total powers, total power factors and values referred to the single phases as shown in the following screen

Press the **SAVE** button or touch the  icon to save the measurement on the display as instantaneous snapshot (see § 7.1)

8. The “” and “” symbols show the Inductive or Capacitive type of the load, respectively.

Press the **SAVE** button or touch the icon to save the measurement on the display as instantaneous snapshot (see § 7.1)

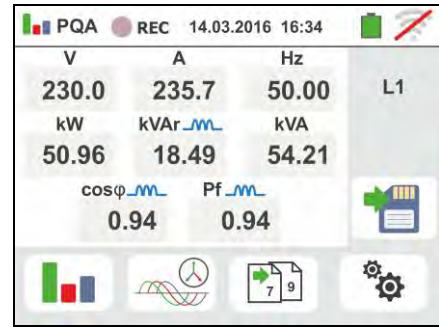

9. Touch the icon to access the pages of absorbed/generated power/energies. The screen like the one to the side in the condition of **recording not activated** is shown

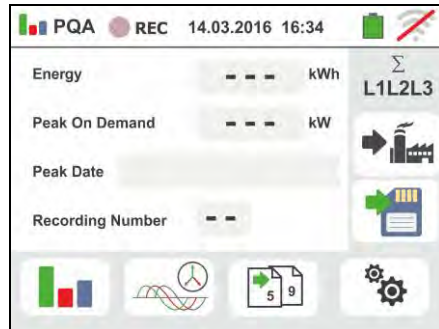

10. Touch the icon to show the pages of input signal waveforms and vector diagrams of voltages/currents. The screen like the one to the side shows the real-time values of phase angles between voltage and current relevant to a three-phase system. The parameters are indicated with small squares in different colors and the angular values are shown on the right side. The positive rotation reference associated with each vector diagram is **clockwise**.

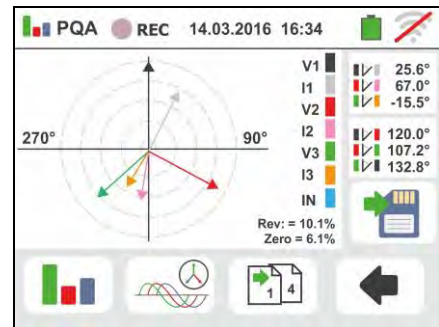

In the bottom part of the display there are the “Rev” and “Zero” indications associated with the unbalance of input voltages (see §)

Press the **SAVE** button or touch the icon to save the measurement on the display as instantaneous snapshot (see § 7.1)

Touch the icon to show the signal waveforms. The following screen (referred to phase L2) is shown on the display

- 11 The screen like the one to the side shows the real-time waveforms of voltage and current relevant to a three-phase system. The parameters are indicated with small squares in different colors and the RMS values are shown on the right side.

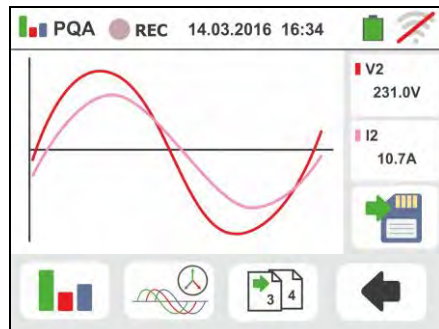

Press the **SAVE** button or touch the icon to save the measurement on the display as instantaneous snapshot (see § 7.1).

Touch the icon to go back to the main screen of RMS values

- 12 Touch the icon to show the parameters of harmonic analysis. The screen like the one to the side shows a three-phase situation. The histogram graph of percentage amplitude relevant to fundamental and voltage/current harmonics from **DC**, from the **1° up to the 49° order**, is shown on the display. A blue frame automatically shows the harmonic with the highest amplitude (except for the fundamental). The numeric value of harmonic amplitude (identified by “**hxx**”) and the THD% value (see §) are shown on the right side. Touch the “◀” or “▶” arrow icons to increase or decrease the harmonic order. Press the **SAVE** button or touch the icon to save the measurement on the display as instantaneous snapshot (see § 7.1). Touch the icon to go back to the main screen of RMS values

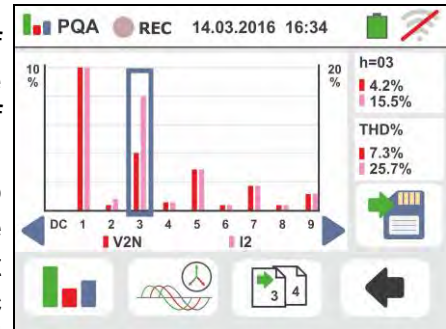

6.10.4. Start recording

- 13 Press the **GO/STOP** key to start recording. The instrument enters stand-by mode (waiting for the next minute or the set date/time) and the “” symbol is displayed as shown in the screen to the side

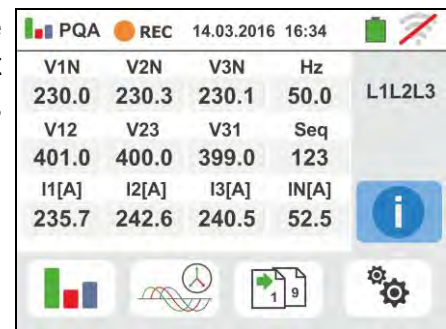

- 14 With recording running, the “” symbol is displayed as shown in the screen to the side.

Touch the “” icon to read in real time the information about the on-going recording. The following screen appears on the display

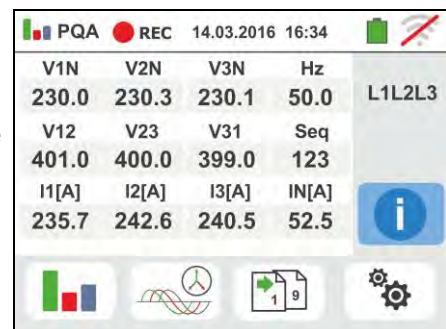



- 15 The screen shows:

- The number of the recording
- The date/time of recording start (if automatic)
- The date/time of recording stop (if automatic)
- The aggregation time set
- The number of aggregation intervals recorded
- The residual memory capacity in DD-HH-MM
- The number of detected voltage anomalies



- 16 Press the **GO/STOP** key to stop recording; the instrument automatically saves the result in its memory (see § 7.1.3). The message to the side is shown.

Confirm by touching the “” icon or touch the “” icon to go back to the previous screen

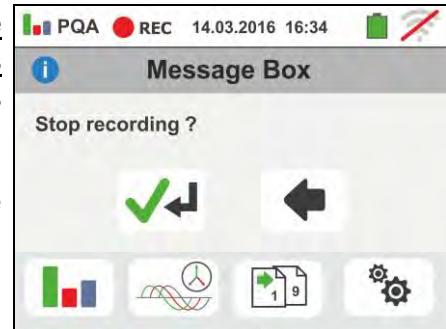

- 17 After recording has stopped, touch the  icon in order to select the display of the **absorbed** power/energy measured by the instrument as shown in the screen to the side. The following items are included:

- The  icon, which indicates the consumption of power/energy **absorbed** by the load
- The value of absorbed energy while recording
- The peak of power absorbed while recording
- The date/time of the above-mentioned peak of power
- The number of recordings to which the above results are referred

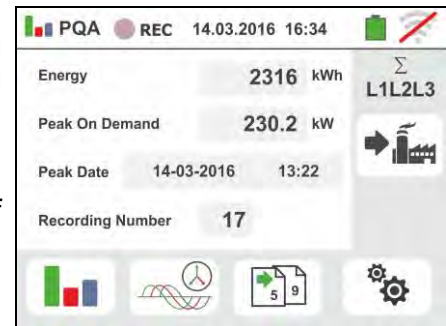

- 18 Touch the  icon in order to select the display of **generated** power/energy measured by the instrument as shown in the screen to the side. The following items are included:

- The  icon, which indicates the consumption of power/energy **generated** by the load
- The value of generated energy while recording
- The peak of power generated while recording
- The date/time of the above-mentioned peak of power
- The number of recordings to which the above results are referred

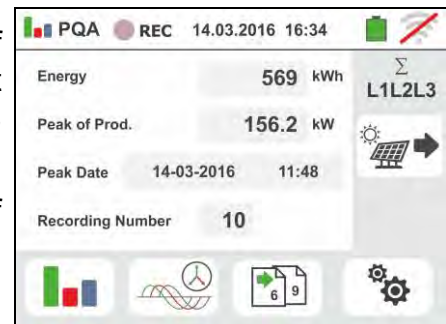

CAUTION

The visualization of powers/energies absorbed/generated are only real time readings and **cannot be saved** inside the instrument's memory.

6.11. LIST OF MESSAGE AT DISPLAY

MESSAGE	DESCRIPTION
Range: 1..15	Values out of range. Check the setup of instrument
Range: 5..999	
Range: 0.01..100	
Range: 1..500	
Range: 0.04..10s	
Range: 0..199	
Range: 1..200	
Range: 1..999	
Range: 1..3000	
Internal synchronization	Synchronization error. Switch off and on the instrument
Checksum error	Communication error. Check the PC connection
Error writing parameter	Contact service department
Serial command error	Communication error. Check the PC connection
Battery low	Replace or recharge batteries
Internal error	Contact service department
Resistance: High temperature	Switch off and let cool the instrument
MOS: High temperature	Switch off and let cool the instrument
Resistance: Low temperature	Contact service department
Test time too long	Switch off and on the instrument and repeat the test
IGBT damaged	Contact service department
Memory full	Memory is full. Download the saved measurements
Two phase system	Function not available in Phase-Phase-PE systems
Not available during a Recording	Function not available during a recording
Error: FRAM writing	Contact service department

7. OPERATIONS WITH THE MEMORY





7.1. SAVING MEASUREMENTS

The structure of the memory is divided into two independent areas for the SAFETY section (safety test and PQA, LEAKAGE, AUX snapshots – max 999 locations) and for RECORDINGS (PQA, AUX, LEAKAGE recordings. The SAFETY section memory is of "tree" type with the possibility to expand/hide the nodes, allows the division up to 3 markers nested so as to finalize the precise locations of the measuring points with the insertion of test results. Each marker has associated up to **20 fixed names (non-editable or deletable)** + max 20 names that can be freely defined by the user by means of management software (see the online help of the program). For each marker, it is also possible to associate a number between 1 and 250.



7.1.1. Saving safety tests and snapshots

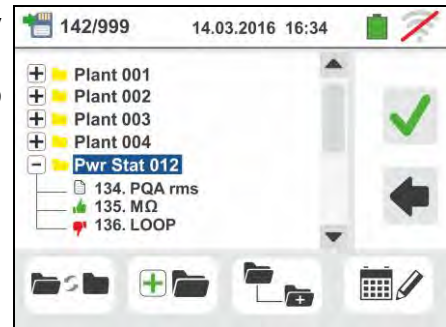

- At the end of each measurement, press the **SAVE** key or touch the  icon to save its result. The screen to the side appears on the display.

The meaning of the icons is the following:

-  → It expands/hides the selected node
-  → It allows the choice of a 1st level node
-  → It inserts a nested sub-node (max 3 levels)
-  → It adds a user comment on the performed measurement



- Press the  or  key to insert a main marker or a sub-marker. The screen to the side is shown by the instrument.

Touch one of the names on the list this to select the desired marker. Touch the arrow keys  or  to enter a number associated with the marker, if needed.

Confirm the choices by returning to the main screen.

Touch the  key. The following screen appears on the display:

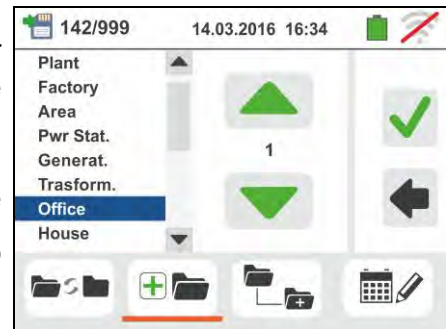

- Use the virtual keyboard to enter any comment on the measurement. This comment will be visible both after downloading the saved data to a PC with management software (see § 8) and recalling the result at display (see § 7.1.2)



Confirm the choices by returning to the main screen.

Further confirm to permanently save the measurement in the internal memory. A confirmation message is provided by the instrument.





7.1.2. Recall and delete safety measurements and snapshots

1. Touch the  icon in the general menu. The screen to the side appears on the display.

Each measurement is identified by the icons  (test with positive result)  (test with negative result) or  (test without outcome). Touch the desired measurement to select it on the display.

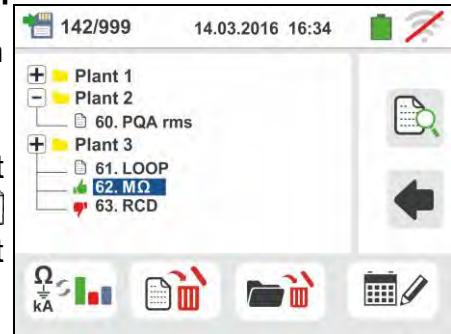
Touch the  icon to recall the measurement result. The following screen appears on the display:





2. Touch the  icon to recall and possibly change the comment entered when saving via the internal virtual keyboard.

Touch the  icon to go back to the previous screen.





3. Touch the  icon to recall the results of saved recordings (see § 7.1.3)

Touch the  icon to delete **the last saved result in the instrument memory**. The following screen appears on the display:

Touch the  icon to confirm the operation or the  icon to return to the previous screen.



4. Touch the  icon to delete **all the results stored in the memory of the instrument**. The following screen appears on the display:

Touch the  icon to confirm the operation or the  icon to return to the previous screen.



7.1.3. Recall and delete saved recordings

The recordings are **automatically** saved inside memory at the pressure of **GO/STOP** key or at the end of set stop date/time. The **SAVE** key allows saving the instantaneous snapshots show at display and follow the same features of safety tests.

Touch the  icon to recall the list of saved recordings (LEAK, AUX and PQA functions) performed by the instrument. The following screen is shown

1. Select the desired recording indicated as "REC_XXX" and touch the  to recall at display. The followed screen is shown

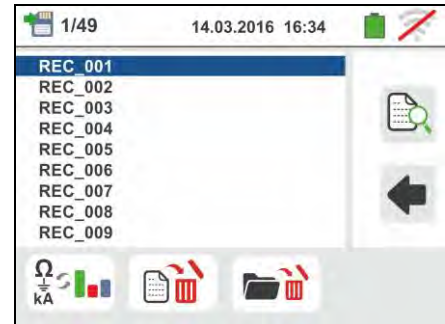

2. In the screen is shown:

- The recording number
- The date/time of start recording (if automatic)
- The date/time of stop recording (if automatic)
- The aggregation time set
- The number of aggregation intervals recorded
- The residual memory capacity expressed in DD-HH-MM
- The number of detected voltage anomalies (sags, swells).



The name of recording is not modify on the instrument.

Touch the  icon to return to the previous screen

Touch the  icon to delete **the last saved recording**

Touch the  icon to delete **all** the saved recordings

7.1.4. Anomalous situations

3. In case there is no measure saved and the instrument memory is accessed, a screen similar to the one reported here to the side is displayed.

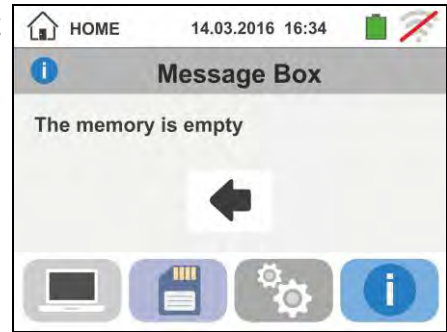

4. In case tries to define a new sub-node over the 3rd level the instrument provides the warning screen shown to the side and blocks the operation



5. In case tries to create a sub-node by using a just used name, the instrument provides the warning screen shown to the side and is necessary to define a new name

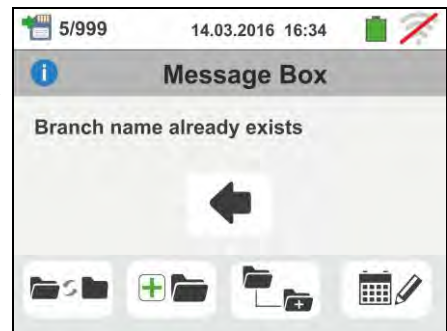

6. In case tries to define a numebr of nodes of 1st, 2nd and 3rd level higher than 250 (for each level), the instrument provides the warning screen shown to the side

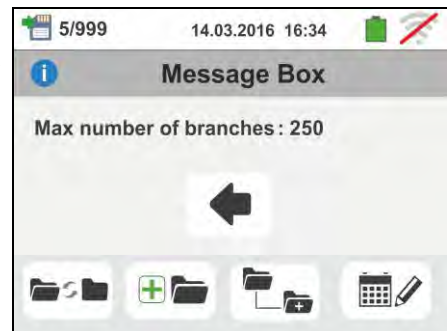

7. In case tries to include a comment of length higher than 30 chars, the instrument provides the warning screen shown to the side





8. CONNECTING THE INSTRUMENT TO A PC OR MOBILE DEVICES

The connection between a PC and the instrument can be done via a serial port (see Fig. 3) by means of an optical cable/USB C2006 or by means a WiFi connection. Before making the connection in USB mode, it is **necessary** to install on the PC the management software TopView downloadable from the www.ht-instruments.com/download website. To transfer stored data to PC keep to the following procedure:

Connection to PC via optical/USB cable

1. Switch on the instrument by pressing the **ON/OFF** key.
2. Connect the instrument to the PC via the optical cable/USB.

3. Touch the  icon in the general menu. The screen to the side is shown by the instrument. Disable the WiFi connection touch the icon in the top right side of the display. The symbol “” appear at display.

In these conditions, the instrument is able to communicate with the PC via USB port



4. Use the management software to download the instrument memory contents to a PC. Please refer to the online help of the program itself for any detail regarding the operation.
5. Touch the  icon to go back to the general menu of the instrument.

Connecting to a PC through WiFi

1. Put the instrument in data transfer mode to a PC (see § 8 - point 3). Enable the WiFi connection touch the icon in the top right side of the display. The symbol “” appear at display. In these conditions, the instrument is able to communicate with the PC via WiFi connectiont



2. Enable the WiFi connection on the target PC (ex: by using a WiFi key installed and connected to a USB port) and connect to the WiFi network enabled by the instrument (name of network “GSC60_XXXXXX” where XXXXXX is the serial number of the instrument)
3. Launch the management software, select the "WiFi" port and "Detect instrument" within the section "PC-Instrument connection"
4. Use the management software to download the instrument memory contents to a PC. Please refer to the online help of the program itself for any detail regarding the operation.

8.1. CONNECTION TO IOS/ANDROID DEVICES THROUGH WIFI

The instrument can be connected remotely via WiFi connection to a Android/iOS smartphones and/or tablets for the transfer of measurement data using the APP **HTAnalysis**. Proceed as follows:

1. Download and install the HTAnalysis on the desired remote device (Android/iOS) (see § 5.2)
2. Put the instrument in data transfer mode to a PC (see § 8 - point 3).
3. Take reference to the HTAnalysis instruction for the management operation

9. USE OF STRAP SET

It is possible to use a strap set (SP-0500 optional accessory) which allows the operator to carry the instrument on his shoulder. The strap set (see Fig. 44) is composed of the following parts:



CAPTION

1. Half-shells with holes for hooks to be inserted in the instrument
2. Hooks for insertion inside the half-shells
3. Shoulder strap with snap-hooks
4. Strap with snap-hooks to fix the instrument to the operator's body

Fig. 44: Strap set parts

How to assemble the parts:

1. Remove the half-shells from the instrument by levering the upper parts and pulling outwards (see Fig. 45)



Fig. 45: Remove lateral half-shells

2. Mount the 4 hooks (see Fig. 44 - part 2) inside the slots on the half-shells of the strap set as shown in Fig. 46. Push each hook fully into the slot until it is completely tightened (click)



Fig. 46: Mounting hooks to fix straps

3. The instrument with the fitted half-shells and hooks must be as shown in Fig. 47



Fig. 47: Instrument with fitted half-shells and hooks

4. Connect the snap-hooks of the shoulder strap (see Fig. 44 - part 3) to the two hooks on the top of the instrument, adjusting the inner part which surrounds the operator's neck (see Fig. 48)



Fig. 48: Complete mounting of set strap

5. Connect the snap-hooks of the strap for fixing the instrument to the operator's body (see Fig. 44 – part 4) to the two hooks at the bottom of the instrument, and adjust the strap to keep the instrument horizontal to the operator (see Fig. 48)

10. MAINTENANCE

10.1. GENERAL INFORMATION

- While using and storing the instrument, carefully observe the recommendations listed in this manual in order to prevent possible damage or danger during use.
- Do not use the instrument in environments with high humidity levels or high temperatures. Do not expose to direct sunlight.
- Always switch off the instrument after use. Should the instrument remain unused for a long time, remove the batteries to avoid liquid leaks that could damage the instruments internal circuits.

10.2. RECHARGING AND REPLACEMENT OF THE BATTERIES

When the LCD display shows the low battery symbol "", recharge the rechargeable batteries or replace the alkaline batteries.



CAUTION

Only expert and trained technicians should perform this operation. Before carrying out this operation, make sure you have disconnected all cables from the input terminals.



CAUTION

Do not connect the adapter A0061 if the instrument is powered by alkaline (not rechargeable) batteries

1. Switch off the instrument by pressing the **ON/OFF** key.
2. Remove the cables from the input leads
3. Loosen the battery compartment cover fastening screw and remove the cover.
4. Remove all the batteries (if not rechargeable) from the battery compartment and replace them with new batteries of the right type only (§ 11.4), making sure to respect the indicated polarities. To recharge the batteries, use the external battery charger A0061 supplied with the instrument. The symbol "" is shown during the recharging process. The batteries can be considered as completely recharged after approx. 12 hours. **The external adapter A0061 does not recharge alkaline batteries.**
5. Restore the battery compartment cover into place and fasten it by mean of the relevant screw.
6. Do not scatter old batteries into the environment. Use the relevant containers for disposal.

10.3. CLEANING THE INSTRUMENT

Use a soft and dry cloth to clean the instrument. Never use wet cloths, solvents, water, etc.

10.4. END OF LIFE



CAUTION: the symbol on the instrument indicates that the appliance and its accessories must be collected separately and correctly disposed of.

11. TECHNICAL SPECIFICATIONS

Accuracy is calculated as: $\pm[\% \text{reading} + (\text{no. of digits}) * \text{resolution}]$ at 23°C, <80%RH.

11.1. TECHNICAL CHARACTERISTICS SAFETY SECTION

AC TRMS voltage

Range [V]	Resolution [V]	Accuracy
15 ÷ 460	1	$\pm(3\% \text{rdg} + 2 \text{digits})$

Continuity of protective conductor (LOW Ω)

Range [Ω]	Resolution [Ω]	Accuracy (*)
0.01 ÷ 9.99	0.01	$\pm(5.0\% \text{reading} + 3 \text{digits})$
10.0 ÷ 99.9	0.1	

(*) after calibration of measuring cables

Test current: >200mA DC up to 2 Ω (cables included)

Test current resolution: 1mA

Open-circuit voltage: $4 < V_0 < 24V$

Safety protection: error message for input voltage > approx. 10V

Insulation resistance (M Ω)

Test voltage [V]	Range [M Ω]	Resolution [M Ω]	Accuracy
50	0.01 ÷ 9.99	0.01	$\pm(2.0\% \text{reading} + 2 \text{digits})$
	10.0 ÷ 49.9	0.1	$\pm(5.0\% \text{reading} + 2 \text{digits})$
	50.0 ÷ 99.9		
100	0.01 ÷ 9.99	0.01	$\pm(2.0\% \text{reading} + 2 \text{digits})$
	10.0 ÷ 99.9	0.1	$\pm(5.0\% \text{reading} + 2 \text{digits})$
	100.0 ÷ 199.9		
250	0.01 ÷ 9.99	0.01	$\pm(2.0\% \text{reading} + 2 \text{digits})$
	10.0 ÷ 99.9	0.1	$\pm(5.0\% \text{reading} + 2 \text{digits})$
	100 ÷ 499	1	
500	0.01 ÷ 9.99	0.01	$\pm(2.0\% \text{reading} + 2 \text{digits})$
	10.0 ÷ 199.9	0.1	
	200 ÷ 499	1	$\pm(5.0\% \text{reading} + 2 \text{digits})$
	500 ÷ 999		
1000	0.01 ÷ 9.99	0.01	$\pm(2.0\% \text{reading} + 2 \text{digits})$
	10.0 ÷ 199.9	0.1	
	200 ÷ 999	1	$\pm(5.0\% \text{reading} + 2 \text{digits})$
	1000 ÷ 1999		

Open-circuit voltage: rated test voltage -0% +10%

Rated measuring current: >1mA with 1k Ω x Vnom (50V, 100V, 250V, 1000V), >2.2mA with 230k Ω @ 500V

Short-circuit current: <6.0mA for each test voltage

Safety protection: error message for input voltage > approx. 10V

Line/Loop impedance (Phase-Phase, Phase-Neutral, Phase-Earth)

Range [Ω]	Resolution [Ω]	Accuracy (*)
0.01 ÷ 9.99	0.01	$\pm(5\% \text{rdg} + 3 \text{digits})$
10.0 ÷ 199.9	0.1	

(*) 0.1 m Ω in range 0.1 ÷ 199.9 m Ω (by using the optional accessory IMP57)

Maximum test current: 5.81A (at 265V); 10.10A (at 457V)

Phase-Neutral/Phase-Phase Test voltage: (100V \pm 265V) / (173V \pm 460V); 50/60Hz \pm 5%

Protection types: MCB (B, C, D, K), Fuse (gG, aM)

Insulating sheath materials: PVC, Butyl rubber, EPR, XLPE

First fault current – IT systems

Range [mA]	Resolution [mA]	Accuracy
0.1 ÷ 0.9	0.1	±(5%reading+1digit)
1 ÷ 999	1	±(5%reading + 3digits)

Limit contact voltage (ULIM) : 25V, 50V

Test on RCD protection (Molded case type)

Differential protection type (RCD): AC (⌚), A/F (⌚), B/B+ (⌚) – General (G), Selective (S) and Delayed (⌚)

Voltage range Phase-Earth, Phase-Neutral: 100V ÷265V RCD type AC and A/F, 190V ÷265V RCD type B/B+

Rated tripping currents (I_{ΔN}): 10mA, 30mA, 100mA, 300mA, 500mA, 650mA, 1000mA

Frequency: 50/60Hz ± 5%

Molded case type RCD tripping current - (for General RCD only)

RCD type	I _{ΔN}	Range I _{ΔN} [mA]	Resolution [mA]	Accuracy
AC, A/F	I _{ΔN} = 10mA	(0.3 ÷ 1.1) I _{ΔN}	≤ 0.1I _{ΔN}	- 0%, +10%I _{ΔN}
	10mA <I _{ΔN} ≤650mA			- 0%, +5%I _{ΔN}
B/B+	30mA ≤I _{ΔN} ≤100mA			- 0%, +5%I _{ΔN}

Measurement duration of Molded case type RCD tripping time – TT/TN systems

	x 1/2			x 1			x 2			x 5			AUTO					
	\	G	S	⌚	G	S	⌚	G	S	⌚	G	S	⌚	G	S	⌚	G	S
10mA	AC	999	999	999	999	999	999	200	250	50	150	✓	✓				310	
	A/F	999	999	999	999	999	999	200	250	50	150	✓	✓				310	
	B/B+																	
30mA 100mA	AC	999	999	999	999	999	999	200	250	50	150	✓	✓				310	
	A/F	999	999	999	999	999	999	200	250	50	150	✓	✓				310	
	B/B+	999	999	999	999	999	999							310				
300mA	AC	999	999	999	999	999	999	200	250	50	150	✓	✓				310	
	A/F	999	999	999	999	999	999	200	250	50	150	✓	✓				310	
	B/B+	999	999	999	999	999	999											
500mA 650mA	AC	999	999	999	999	999	999	200	250	50	150	✓	✓				310	
	A/F	999	999	999	999	999	999	200	250							310		
	B/B+																	
1000mA	AC	999	999	999	999	999	999	200	250									
	A/F	999	999	999	999	999	999											
	B/B+																	

Table with duration of tripping time measurement [ms] - Resolution: 1ms, Accuracy:±(2.0%reading + 2digits)

Measurement duration of Molded case type RCD tripping time – IT systems

	x 1/2			x 1			x 2			x 5			AUTO					
	\	G	S	⌚	G	S	⌚	G	S	⌚	G	S	⌚	G	S	⌚	G	S
10mA	AC	999	999	999	999	999	999	200	250	50	150	✓	✓				310	
	A/F																	
	B/B+																	
30mA 100mA 300mA	AC	999	999	999	999	999	999	200	250	50	150	✓	✓				310	
	A/F																	
	B/B+																	
500mA 650mA	AC	999	999	999	999	999	999	200	250	50	150	✓	✓				310	
	A/F																	
	B/B+																	
1000mA	AC	999	999	999	999	999	999	200	250									
	A/F																	
	B/B+																	

Table with duration of tripping time measurement [ms] - Resolution: 1ms, Accuracy:±(2.0%reading + 2digits)

Test on RCD without integral current breaking device (with accessory RCDX10)

Differential protection type (RCD): AC (⌚), A/F (⌚⌚), B/B+ (⌚⌚⌚), General (G), Selective (S), Delayed (⌚)
 Voltage range Phase-Earth, Phase-Neutral: 100V ÷ 265V RCD type AC and A/F, 190V ÷ 265V RCD type B/B+
 Rated tripping currents (I_{ΔN}): 0.3A ÷ 10A
 Frequency: 50/60Hz ± 5%

RCD without integral current breaking device tripping current - (for General RCD only)

RCD type	I _{ΔN}	Range I _{ΔN} [mA]	Resolution [mA]	Accuracy
AC, A/F	300mA < I _{ΔN} ≤ 6.5A	(0.3 ÷ 1.1) I _{ΔN}	≤ 0.1 I _{ΔN}	- 0%, +5% I _{ΔN}
B(B+)	300mA ≤ I _{ΔN} ≤ 1A			

Duration of RCD without integral current breaking device tripping time – TT/TN systems

	x 1/2			x 1			x 2			x 5			AUTO					
	\	G	S	⌚	G	S	⌚	G	S	⌚	G	S	⌚	G	S	⌚	G	S
0.3A ÷ 1.0A	AC	999	999	999	999	999	999	200	250	50	150	✓	✓				310	
	A/F	999	999	999	999	999	999	200	250	50	150	✓	✓				310	
	B/B+	999	999	999	999	999	999							310				
1.1A ÷ 3.0A	AC	999	999	999	999	999	999	200	250	50	150	✓	✓				310	
	A/F	999	999	999	999	999	999	200	250	50	150	✓	✓				310	
	B/B+	999	999	999	999	999	999							310				
3.1A ÷ 6.5A	AC	999	999	999	999	999	999	200	250	50	150	✓	✓				310	
	A/F	999	999	999	999	999	999	200	250	50	150	✓	✓				310	
	B/B+	999	999	999	999	999	999							310				
6.6A ÷ 10.0A	AC	999	999	999	999	999	999	200	250									
	A/F	999	999	999	999	999	999											
	B/B+																	

Table with duration of tripping time measurement [ms] - Resolution: 1ms, Accuracy: ±(2.0% reading + 2 digits)

Duration of RCD without integral current breaking device tripping time – IT systems

	x 1/2			x 1			x 2			x 5			AUTO					
	\	G	S	⌚	G	S	⌚	G	S	⌚	G	S	⌚	G	S	⌚	G	S
0.3A ÷ 3.0A	AC	999	999	999	999	999	999	200	250	50	150	✓	✓				310	
	A/F																	
	B/B+																	
3.1A ÷ 6.5A	AC	999	999	999	999	999	999	200	250	50	150	✓	✓				310	
	A/F																	
	B/B+																	
6.6A ÷ 10.0A	AC	999	999	999	999	999	999	200	250									
	A/F																	
	B/B+																	

Table with duration of tripping time measurement [ms] - Resolution: 1ms, Accuracy: ±(2.0% reading + 2 digits)

Overall earth resistance without RCD tripping (R_a)

Voltage range Phase-Earth, Phase-Neutral: 100 ÷ 265V, Frequency: 50/60Hz ± 5%

Global earth resistance in systems with Neutral

Range [Ω]	Resolution [Ω]	Accuracy
0.01 ÷ 9.99	0.01	±(5% reading + 0.1Ω)
10.0 ÷ 199.9	0.1	±(5% reading + 1Ω)
200 ÷ 1999	1	±(5% reading + 3Ω)

Ut LIM (UL): 25V or 50V, Maximum current: < 15mA

Global earth resistance in systems without Neutral

Range [Ω]	Resolution [Ω]	Accuracy
1 ÷ 1999	1	-0%, +(5.0% rdg + 3Ω)

Maximum current: < ½ I_{ΔN} set ; Ut LIM (UL): 25V or 50V

Contact voltage (measured during RCD and Ra test)

Range [V]	Resolution [V]	Accuracy
0 ÷ Ut LIM	0.1	-0%, +(5.0% rdg + 3V)

Contact voltage (EARTH test – TT systems)

Range [V]	Resolution [V]	Accuracy
0 ÷ 99.9	0.1	-0%, +(5.0% lettura + 3V)

Contact voltage (EARTH test – TN systems)

Range [V]	Resolution [V]	Accuracy
0 ÷ 99.9	0.1	-0%, +(5.0% rdg + 3V)
100 ÷ 999	1	-0%, +(5.0% rdg + 3V)

Earth resistance

Range [Ω]	Resolution [Ω]	Accuracy (*)
0.01 ÷ 9.99	0.01	$\pm(5\% \text{ reading} + 3 \text{ digits})$
10.0 ÷ 99.9	0.1	
100 ÷ 999	1	
1.00k ÷ 49.99k	0.01k	

Test current: <10mA, 77.5Hz; Open-circuit voltage: <20Vrms

(*) If $100 \cdot R_{\text{meas}} < (R_s \text{ or } R_h) < 1000 \cdot R_{\text{meas}}$, add 5% to the accuracy. Accuracy not declared if $(R_s \text{ or } R_h) > 1000 \cdot R_{\text{mis}}$

Ground resistivity

Range [ΩM]	Resolution [Ωm]	Accuracy
0.06 ÷ 9.99	0.01	$\pm(5\% \text{ reading} + 3 \text{ digits})$
10.0 ÷ 99.9	0.1	
100 ÷ 999	1	
1.00k ÷ 9.99k	0.01k	
10.0k ÷ 99.9k	0.1k	
100k ÷ 999k (*)	1k	
1.00M ÷ 3.14M (*)	0.01M	

(*) with distance between the probes $d = 10\text{m}$; Distance range: $1 \div 10\text{m}$

Test current: <10mA, 77.5Hz; Open-circuit voltage: <20Vrms

Phase rotation with 1 test lead

Voltage range P-N, P-PE[V]	Frequency range
100 ÷ 265	50Hz/60Hz $\pm 5\%$

Measurement is only carried out by direct contact with metal live parts (not on insulation sheath).

Voltage drop

Range [%]	Resolution [%]	Accuracy
0 ÷ 100	0.1	$\pm(10\% \text{ rdg} + 4 \text{ dgt})$

Voltage range Phase-Earth, Phase-Neutral: 100 ÷ 265V, Frequency: 50/60Hz $\pm 5\%$

Leakage current (input I1 – STD clamp)

FS AC Clamp [A]	Resolution [A]	Accuracy
1	0.1mA	$\pm(1\% \text{ rdg} + 20 \text{ dgt})$
1 < FS < 10	0.01A	
10 \leq FS < 100	0.1A	
100 \leq FS \leq 1000	1A	

Environmental parameters

Measurement	Range	Resolution	Accuracy
°C	-20.0 ÷ 60.0°C	0.1°C	±(2%rdg + 2digits)
°F	-4.0 ÷ 140.0°F	0.1°F	
RH%	0.0% ÷ 100.0%RH	0.1%RH	
DC voltage	0.1mV ÷ 1.0V	0.1mV	
Lux	0.001 ÷ 20.00lux (*)	0.001 ÷ 0.02Lux	
	0.1 ÷ 2.0klux (*)	0.1 ÷ 2Lux	
	1 ÷ 20.0klux (*)	1 ÷ 20Lux	

(*) Accuracy of the luxmetric probe according to Class AA

11.2. TECHNICAL CHARACTERISTICS PQA SECTION
DC/AC TRMS Voltage (Phase-Neutral)

Range [V]	Resolution [V]	Accuracy
15.0 ÷ 380.0	0.1V	$\pm(1.0\%rdg + 1dgt)$

 Crest factor: $\leq 1,5$; Frequency: 42 ÷ 69.0 Hz

DC/AC TRMS Voltage (Phase-Phase)

Range [V]	Resolution [V]	Accuracy
15.0 ÷ 660.0	0.1V	$\pm(1.0\%rdg + 1dgt)$

 Crest factor: $\leq 1,5$; Frequency: 42 ÷ 69.0 Hz

Frequency

Range [Hz]	Resolution [Hz]	Accuracy
DC, 42 ÷ 69.0	0.01	$\pm(2.0\%rdg + 2dgt)$

Allowed voltage: 15.0 ÷ 660V ; Allowed current: 5%FS clamp ÷ FS clamp

DC/AC TRMS Current (STD clamp)

FS clamp	Range [A]	Resolution [A]	Accuracy
$\leq 10A$	5% FS ÷ 9.99	0.01	$\pm(1.0\%rdg + 3 dgt)$
$10A \leq FS \leq 300$	5% FS ÷ 299.9	0.1	
$300A \leq FS \leq 3000$	5% FS ÷ 2999	1	

 Range: 5 ÷ 999.9 mV, values under 5mV are zeroed, Crest factor: ≤ 2.4 ; Frequency: 42 ÷ 69.0 Hz

AC TRMS Current (FLEX Clamp - 300A AC range)

Range [mV]	Frequency [Hz]	Resolution	Accuracy	Overload protection
0.085 ÷ 85.0	42 ÷ 65.0	8.5 μ V	$\pm(0.5\%rdg+0.17\%FS)$	10V

 Crest factor ≤ 3 . Allowed current <1A are zeroed

AC TRMS Current (FLEX Clamp - 3000A AC range)

Range [mV]	Frequency [Hz]	Resolution	Accuracy	Overload protection
0.425 ÷ 255.0	42 ÷ 65.0	85 μ V	$\pm(0.5\%lettura+0.17\%FS)$	10V

 Crest factor ≤ 3 . Allowed current <10A are zeroed

DC Power

FS clamp	Range [kW]	Resolution [kW]	Accuracy
$\leq 10A$	0.000 ÷ 9.999	0.001	$\pm(2.0\%rdg + 7dgt)$
	10.00 ÷ 99.99	0.01	
$10A < FS \leq 200A$	0.00 ÷ 99.99	0.01	
	100.0 ÷ 999.9	0.1	
$200A < FS \leq 1000A$	0.0 ÷ 999.9	0.1	
	1000 ÷ 9999	1	

Active power (@ 230V, I > 5% FS, $\cos\phi \geq 0.5$, f=50.0Hz)

FS clamp	Range [kW]	Resolution [kW]	Accuracy
$\leq 10A$	0.000 ÷ 9.999	0.001	$\pm(2.0\%rdg + 7dgt)$
	10.00 ÷ 99.99	0.01	
$10A < FS \leq 200$	0.00 ÷ 99.99	0.01	
	100.0 ÷ 999.9	0.1	
$200A < FS \leq 1000$	0.0 ÷ 999.9	0.1	
	1000 ÷ 9999	1	
$1000A < FS \leq 3000$	0 ÷ 9999	1	

Reactive power (@ 230V, I > 5% FS, $\cos\phi < 0.9$, f=50.0Hz)

FS clamp	Range [kVAr]	Resolution [kVAr]	Accuracy
≤ 10A	0.000 ÷ 9.999	0.001	±(2.0%rdg + 7dgt)
	10.00 ÷ 99.99	0.01	
10A < FS ≤ 200	0.00 ÷ 99.99	0.01	
	100.0 ÷ 999.9	0.1	
10A < FS ≤ 200	0.0 ÷ 999.9	0.1	
	1000 ÷ 9999	1	
1000A < FS ≤ 3000	0 ÷ 9999	1	

Power factor / $\cos\phi$ (@ 230V, I > 5%FS)

Range	Resolution	Accuracy
0.70c ÷ 1.00 ÷ 0.70i	0.01	±(2.0%rdg + 3rdg)

Voltage harmonics (@ 230V in 1Ph systems, 400V in 3Ph systems)

Range [%]	Resolution [%]	Ordine	Accuracy
0.1 ÷ 100.0	0.1	DC, 01 ÷ 49	±(5.0%rdg + 5rdg)

Fundamental frequency: 42 ÷ 69.0 Hz

Harmonics are zeroed at the below conditions::

- DC : DC value <0.5% fundamental value or DC value < 1.0V
- 1° Harmonic: value of 1° Harmonic < 15V
- 2nd ÷ 49th Harmonics: harmonic value <0.5% fundamental value or if value < 1.0V

Current harmonics

Range [%]	Resolution [%]	Order	Accuracy
0.1 ÷ 100.0	0.1	DC, 01 ÷ 49	±(5.0%rdg + 5rdg)

Fundamental frequency: 42 ÷ 69.0 Hz

Harmonics are zeroed at the below conditions::

- DC : DC value <0.5% fundamental value or DC value <0.5% FS clamp
- 1° Harmonic: value of 1° Harmonic < 0.5% FS clamp
- 2nd ÷ 49th Harmonics: harmonic value <0.5% fundamental value or if value < 0.5% FS clamp

Voltage anomalies (Phase-Neutral, Phase-PE)

Range [V]	Resolution [V]	Resolution [ms]	Accuracy [V]	Accuracy [ms]
15.0 ÷ 380.0	0.2	20ms	±(1.0%rdg + 2dgt)	± 1cycle

Voltage anomalies (Phase-Phase)

Range [V]	Resolution [V]	Resolution [ms]	Accuracy [V]	Accuracy [ms]
15.0 ÷ 660	0.2	20ms	±(1.0%rdg + 2dgt)	± 1cycle

11.3. REFERENCE GUIDELINES

Safety:	IEC/EN61010-1, IEC/EN61557-1, IEC60364
EMC :	IEC/EN61326-1
EMC ambient of use :	industrial, Class A, Group 1
Technical documentation:	IEC/EN61187
Safety of measuring accessories:	IEC/EN61010-031, IEC/EN61010-2-032
Insulation:	double insulation
Pollution level:	2
Max operating altitude:	2000m (6562ft)
Protection index:	IP40
Measurement category:	CAT IV 300V to ground, CAT III 350V to ground max 600VAC between inputs
LOW Ω (200mA):	IEC/EN61557-4
M Ω :	IEC/EN61557-2
RCD:	IEC/EN61557-6 (only on Phase-Neutral-Earth systems)
LOOP P-P, P-N, P-PE:	IEC/EN61557-3
EARTH:	IEC/EN61557-5
Multifunction:	IEC/EN61557-10
Short circuit current :	EN60909-0
Earth resistance TN system:	EN61936-1 + EN50522 (no USA, Germany, Extra Europe)
Network quality:	EN50160

11.4. GENERAL CHARACTERISTICS

Mechanical characteristics

Size (L x W x H):	225 x 165 x 75mm ; (9 x 6 x 3in)
Weight (batteries included):	1.2kg ; (42 ounces)

Power supply

Battery type:	6 x1.2V rechargeable batteries NiMH type AA 6x1.5V alkaline batteries type AA IEC LR06 MN1500
Low battery indication:	low battery symbol  on the display
Battery life:	> 500 tests for each function > 6 hours in recording
Recharging time:	approx. 12 hours
External adapter:	100-240VAC, 50/60Hz / 15VDC, CAT IV 300V
Auto Power OFF:	after 5 minutes idling (if activated)

Miscellaneous

Display:	TFT, color, capacitive touch-screen, 320x240mm
Aggregation time:	2s to 30min selectable
Memory for safety test:	999 memory locations, 3 levels of markers
Memory for recordings:	8MB (not expandible)
Connection to PC:	optical/USB port
Remote connection:	WiFi connection

11.5. ENVIRONMENT

11.5.1. Environmental conditions for use

Reference temperature:	23° ± 5°C ; (73°F ± 41°F)
Operating temperature:	0 ÷ 40°C ; (32°F ÷ 104°F)
Allowable relative humidity:	<80%RH
Storage temperature:	-10 ÷ 60°C ; (14°F ÷ 140°F)
Storage humidity:	<80%RH

This instrument satisfies the requirements of Low Voltage Directive 2014/35/EU (LVD) and of EMC Directive 2014/30/EU

This instrument satisfies the requirements of European Directive 2011/65/EU (RoHS) and European Directive 2012/19/EU (WEEE)

11.6. ACCESSORIES

See the attached packing list.

12. SERVICE

12.1. WARRANTY CONDITIONS

This instrument is warranted against any material or manufacturing defect, in compliance with the general sales conditions. During the warranty period, defective parts may be replaced. However, the manufacturer reserves the right to repair or replace the product. Should the instrument be returned to the After-sales Service or to a Dealer, transport will be at the Customers charge. However, shipment will be agreed in advance. A report will always be enclosed to a shipment, stating the reasons for the products return. Only use original packaging for shipment. Any damage due to the use of non-original packaging material will be charged to the Customer. The manufacturer declines any responsibility for injury to people or damage to property.

The warranty shall not apply in the following cases:

- Repair and/or replacement of accessories and battery (not covered by warranty).
- Repairs that may become necessary as a consequence of an incorrect use of the instrument or due to its use together with non-compatible appliances.
- Repairs that may become necessary as a consequence of improper packaging.
- Repairs which may become necessary as a consequence of interventions performed by unauthorized personnel.
- Modifications to the instrument performed without the manufacturer's explicit authorization.
- Use not provided for in the instruments specifications or in the instruction manual.

The content of this manual cannot be reproduced in any form without the manufacturer's authorization.

Our products are patented and our trademarks are registered. The manufacturer reserves the right to make changes in the specifications and prices if this is due to improvements in technology.

12.2. SERVICE

If the instrument does not operate properly, before contacting the After-sales Service, please check the conditions of batteries and cables and replace them, if necessary. Should the instrument still operate improperly, check that the product is operated according to the instructions given in this manual. Should the instrument be returned to the After-sales Service or to a Dealer, transport will be at the Customer's charge. However, shipment will be agreed in advance. A report will always be enclosed to a shipment, stating the reasons for the products return. Only use original packaging for shipment; any damage due to the use of non-original packaging material will be charged to the Customer.

13. THEORETICAL APPENDICES

13.1. CONTINUITY OF PROTECTIVE CONDUCTORS

Purpose of the test

Check the continuity of:

- Protective conductors (PE), main equalizing potential conductors (EQP), secondary equalizing potential conductors (EQS) in TT and TN-S systems
- Neutral conductors having functions of protective conductors (PEN) in TN-C system.

This test is to be preceded by a visual check verifying the existence of yellow-green protective and equalizing potential conductors as well as compliance of the sections used with the standards requirements.

Parts of the system to be checked

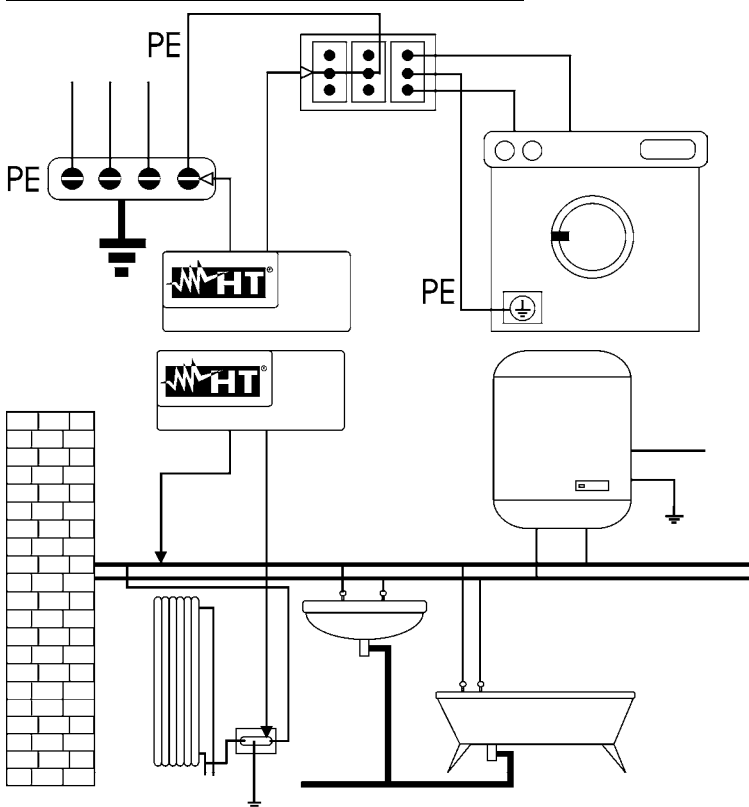

Connect one of the test leads to the protective conductor of the socket and the other to the equalizing potential node of the earth installation.

Connect one of the test leads to the external mass (in this case the water pipe) and the other to the earth installation using for example the protective conductor of the closest socket.

Fig. 49: Examples for continuity measurements on conductors

Check the continuity among:

- Earth poles of all the plug sockets and earth collector or node
- Earth terminals of class I appliances (boilers, etc.) and earth collector or node
- Main external masses (water tubes, gas pipes, etc.) and earth collector or node
- Additional external masses between each other and to earth terminal.

Allowable values

The standards do not require the measurement of continuity resistance and the comparison of the results with limit values. The standards simply require that the instrument in use warns the operator if the test was not carried out with a current of at least 200mA and an open circuit voltage ranging from 4 to 24V. The resistance values may be calculated according to the sections and lengths of the conductors under test. In general, if the instrument detects values of some ohms, the test may be considered as successful.

13.2. INSULATION RESISTANCE

Purpose of the test

Check that the insulation resistance of the installation complies with the requirements of the applicable guidelines. This test has to be performed with the circuit being tested not powered and with the possible loads it supplies disconnected.

Parts of the system to be checked

Check that the insulation resistance between:

- Each active conductor and the earth (the neutral conductor is considered as an active conductor except in TN-C power supply systems, where it is considered as part of the earthing (PEN)). During this measurement, all active conductors may be connected to each other. Should the measurement result not to be within the limits prescribed by the standards, the test must be repeated separately for each single conductor.
- The active conductors. The guidelines recommends also checking the insulation between active conductors when this is possible.

Allowable values

The values of the measured voltage and of the minimum insulation resistance can be taken from the following table

Circuit nominal voltage [V]	Test voltage [V]	Insulation resistance [MΩ]
SELV and PELV *	250	≥ 0,250
Up to/equal to 500 V, except for the above-mentioned circuits	500	≥ 1,000
Over 500 V	1000	≥ 1,000

* The terms SELV and PELV replace, in the standards new wording, the old definitions of "Very low safety voltage" or "Very low functional voltage"

Table 3: Most common test types, insulation resistance measurement

If the system includes electronic devices, it is necessary to disconnect them from the system to prevent any damage. Should this not be possible, only perform the test between active conductors (which, in this case, must be connected to each other) and the earth connection.

In the presence of a very extended circuit, wires running side by side constitute a capacity that the instrument must load in order to obtain a correct measurement; in this case it is advisable to hold the start button of the measurement (in case you run the test in manual mode) until the result is stable.

The "> full scale" message indicates that the insulation resistance measured by the instrument is higher than the maximum measurable resistance, this result is obviously much higher than the minimum limits in the standard table above, so the insulation at that point is to be considered compliant.

13.3. CHECKING CIRCUIT SEPARATION

Definitions

A **SELV** system is a zero-category system or safety extra low voltage system characterized by power supply from an independent (e.g. batteries, small generator set) or safety source (e.g. safety transformer), protective separation from other electrical systems (double or reinforced insulation or earthed metal screen) and absence of earthed points (insulated from the earth).

A **PELV** system is a zero-category system or protective extra low voltage system characterized by power supply from an independent (e.g. batteries, small generator set) or safety source (e.g. safety transformer), protective separation from other electrical systems (double or reinforced insulation or earthed metal screen) and, unlike **SELV** systems, presence of earthed points (not insulated from the earth).

A system with **Electrical Separation** is a system characterized by a power supply from an insulation transformer or independent source with equivalent characteristics (e.g. motor generator set), protective separation from other electrical systems (insulation no lower than that of the insulation transformer), protective separation to earth (insulation no lower than that of the insulation transformer).

Purpose of the test

The test, to be performed if protection is obtained through separation must check that the insulation resistance measured as described below (according to the type of separation) complies with the limits reported in the table relating to insulation measurements.

Parts of the system to be checked

- **SELV** System (Safety Extra Low Voltage):
 - ✓ Measure the resistance between the active parts of the circuit being tested (separated) and the active parts of the other circuits.
 - ✓ Measure the resistance between the active parts of the circuit to be tested (separated) and the earth.
- **PELV** System (Protective Extra Low Voltage):
 - ✓ Measure the resistance between the active parts of the circuit being tested (separated) and the active parts of the other circuits.

Electrical separation:

- ✓ Measure the resistance between the active parts of the circuit being tested (separated) and the active parts of the other circuits.
- ✓ Measure the resistance between the active parts of the circuit to be tested (separated) and the earth.

Allowable values

The test has a positive result when the insulation resistance shows values higher or equal to those indicated in Table 3.

EXAMPLE OF SEPARATION TEST BETWEEN ELECTRICAL CIRCUITS

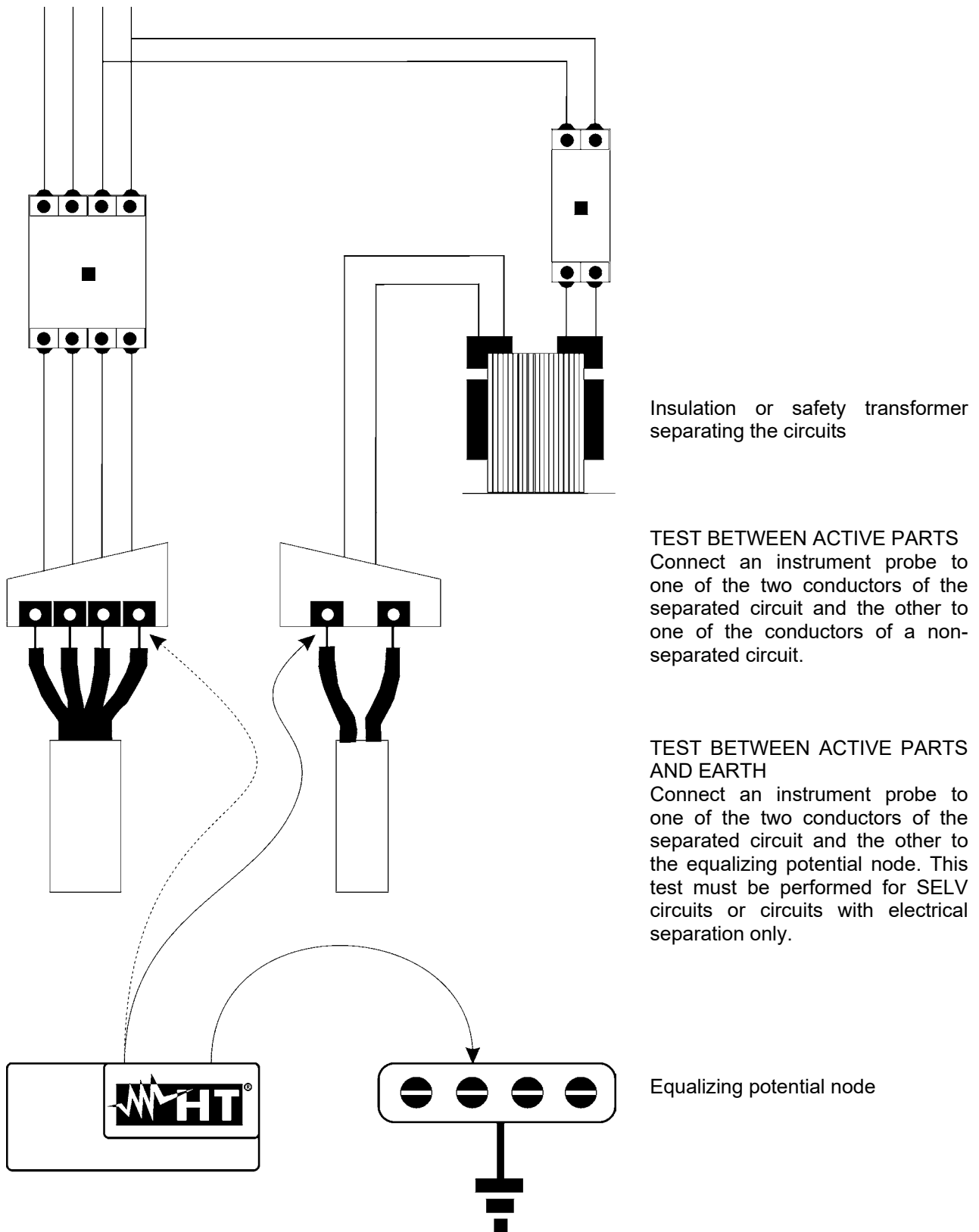

Fig. 50: Separation measurements between the circuits of a system

13.4. TEST ON DIFFERENTIAL SWITCHES (RCD)

Purpose of the test

Checking that the General (G) and Selective (S) and Delayed (Ⓝ) differential protection devices have been correctly installed and adjusted and that they maintain their characteristics over time. The check must make sure that the differential switch trips at a current not higher than its nominal operating current I_{dN} and that the tripping time meets the following conditions, according to the case:

- The tripping time does not exceed the maximum time as prescribed by the standard for differential switches of a General type (according to what described in Table 4).
- The tripping time is between the minimum and the maximum tripping time for differential switches of a Selective type (according to what described in Table 4).
- It does not exceed the maximum delay time (normally set by the user) in case of Delayed differential switches.

The differential switch test performed with the test key helps so that no “gluing effect” jeopardizes the operation of the device if it has remained unused for a long time. This test is only performed to ascertain the mechanical functionality of the device and it is not sufficient to declare the devices conformity to the standard regarding differential current devices. According to statistics, switch verification through test key, if performed once a month, reduces to a half the devices malfunction rate. However, this test only detects 24% of the defective differential switches.

Parts of the system to be checked

All differential switches must be tested upon installation. In low-voltage systems, it is advisable to perform this test, fundamental in order to guarantee a correct safety level. In medical rooms, this test must be performed periodically on all differential switches as prescribed by the guidelines.

Allowable values

On each molded type RCD two tests must be performed on each differential switch: a test with a leakage current beginning in phase with the positive half-wave of voltage (0°) and a test with a leakage current beginning in phase with the negative half-wave of voltage (180°). The result to be considered is the higher one. The test with $\frac{1}{2}I_{dN}$ must not cause the differential switch tripping.

RCD type	$I_{dN} \times 1$	$I_{dN} \times 2$	$I_{dN} \times 5^*$	Description
General	0.3s	0.15s	0.04s	Maximum tripping time in seconds
Selective S	0.13s	0.05s	0.05s	Minimum tripping time in seconds
	0.5s	0.20s	0.15s	Maximum tripping time in seconds

Table 4: Tripping times for general and selective differential switches

Measurement of tripping current for protection differential switches

- This test aims at checking the real tripping current of general differential switches (**it does not apply to selective differential switches**).
- In the presence of differential switches with selectable tripping current, it is useful to perform this test in order to check the real tripping current of the differential switch. For differential switches with fixed differential current, this test may be performed in order to detect possible leakages of the users connected to the system.
- Should an earth system not be available, perform the test by connecting the instrument to a terminal on a conductor downstream of the differential device and a terminal on the other conductor upstream of the device.
- Tripping current must be between $\frac{1}{2}I_{dN}$ and I_{dN} .

13.5. VERIFY OF THE BREAKING CAPACITY OF PROTECTION DEVICES

Purpose of the test

Checking that the breaking capacity of the protection device is higher than the maximum fault current possible in the system.

Parts of the system to be checked

The test must be performed at the point in which the maximum short-circuit current is possible, normally immediately downstream of the protection device to be checked.

The test must be performed between phase and phase (Z_{pp}) in three-phase systems and between phase and neutral (Z_{pn}) in single-phase systems.

Allowable values

The instrument performs the comparison between the measured value and the value calculated according to the following relationships derived from standard EN60909-0:

$$BC > I_{MAX\ 3\Phi} = C_{MAX} \cdot \frac{\frac{U_{L-L}^{NOM}}{\sqrt{3}}}{\frac{Z_{L-L}}{2}}$$

Three-phase systems

$$BC > I_{MAX\ L-N} = C_{MAX} \cdot \frac{U_{L-N}^{NOM}}{Z_{L-N}}$$

Single-phase systems

where: BC = breaking capacity of protection device
 Z_{LL} = Impedance measured between phase and phase
 Z_{LN} = Impedance measured between phase and neutral

Measured voltage	U_{NOM}	C_{MAX}
$230V-10\% < V_{measured} < 230V+ 10\%$	230V	1.05
$230V+10\% < V_{measured} < 400V- 10\%$	$V_{measured}$	1.10
$400V-10\% < V_{measured} < 400V+ 10\%$	400V	1.05

13.6. VERIFY OF PROTECTION AGAINST INDIRECT CONTACTS IN TN SYSTEMS

Purpose of the test

The protection against indirect contacts in the TN systems must be guaranteed by means of a protection device against the overcurrents (typically MCB or fuse) which switch off the power supply of the circuit or the electrical equipment in case of a fault between an active part and a ground mass or a protection conductor within an interval not exceeding 5s, sufficient for the equipments, or in compliance with the times declared in the following table. For USA and Norway countries refer to the respective guidelines.

U ₀ [V]	Trip out time of protection [s]
50 ÷ 120	0.8
120 ÷ 230	0.4
230 ÷ 400	0.2
>400	0.1

Table 5: Tripping times for protection devices

U₀ = nominal AC voltage refer to ground of the system

The above conditions is satisfied by the following relationship:

$$Z_s \cdot I_a \leq U_0$$

where:

- Z_s = Fault Loop P-PE impedance which includes the phase winding of the transformer, the line conductor up to the fault point and the protective conductor from the fault point to the star center of the transformer
- I_a = Tripping current of the protection device within the specified time in Table 5
- U₀ = nominal AC voltage refer to ground

CAUTION



The instrument must be used to measure fault loop impedance values at least 10 times higher than the resolution value of the instrument in order to minimize errors.

Parts of the system to be checked

The test must necessarily be performed on TN and IT systems not protected by differential devices.

Allowable values

The measurement is aimed at ensuring that in every point of the system the relationships derived from standard EN60909-0 are satisfied:

$$I_a \leq I_{MIN P-PE} = C_{MIN} \cdot \frac{U_{P-PE}^{NOM}}{Z_{P-PE}}$$

Measured voltage	U _{NOM}	C _{MIN}
230V-10% < V _{measured} < 230V+ 10%	230V	0.95
230V+10% < V _{measured} < 400V- 10%	V _{measured}	1.00
400V-10% < V _{measured} < 400V+ 10%	400V	0.95

Depending on the set values of phase-phase, phase-neutral or phase-PE voltage (see § 5.1.4) and the measured value of fault loop impedance, the instrument calculates the **minimum value** of the assumed short-circuit current to be interrupted by the protection device. For proper coordination, this value **MUST** always be greater than or equal to the **I_a** value of the tripping current of the type of protection considered as worst case

The **I_a** reference value (see Fig. 51) depends on:

- Protection type (curves B, C, D, K)
- Rated current of the protection device I_n
- Time of fault extinction by the protection

Typically: I_a = 3÷5I_n (curve B), I_a = 5÷10I_n (curve C), I_a = 10÷20I_n (curves D,K)

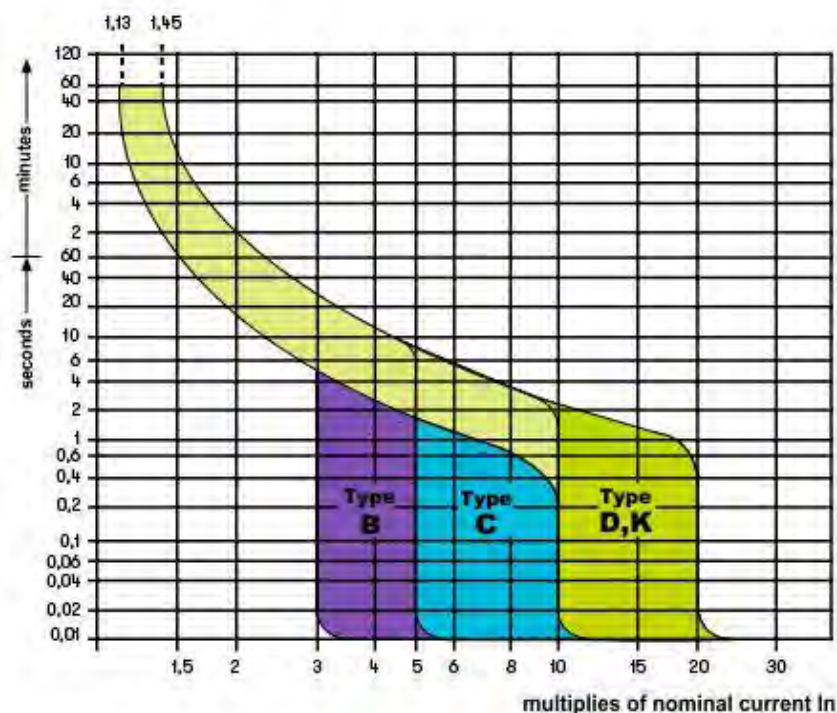

Fig. 51: Example of curves relative to magnetothermal (MCB) protection

The instrument allows the selection (*) of the following parameters:

- MCB current (B curve) selectable among values:
6, 10, 13, 15, 16, 20, 25, 32, 40, 50, 63A
- MCB current (C, K curves) selectable among values:
0.5, 1, 1.6, 2, 4, 6, 10, 13, 15, 16, 20, 25, 32, 40, 50, 63A
- MCB current (D curve) selectable among values:
0.5, 1, 1.6, 2, 4, 6, 10, 13, 15, 16, 20, 25, 32A
- Nominal current Fuse gG selectable among values: **2, 4, 6, 8, 10, 12, 13, 16, 20, 25, 32, 40, 50, 63, 80, 100, 125, 160, 200, 250, 315, 400, 500, 630, 800, 1000, 1250A**
- Nominal current Fuse aM selectable among values: **2, 4, 6, 8, 10, 12, 16, 20, 25, 32, 40, 50, 63, 80, 100, 125, 160, 200, 250, 315, 400, 500, 630A**
- Time of fault extinction by the protection selectable among: **0.1s, 0.2s, 0.4s, 1s, 5s**

(*) The values could be subject to variations

13.7. VERIFY OF PROTECTION AGAINST INDIRECT CONTACTS IN TT SYSTEMS

Purpose of the test

Checking that the protection device is coordinated with the value of earth resistance. We cannot assume a priori a reference limit value for earth resistance as a reference when checking the measurements result. It is necessary to check each time that the coordination prescribed by the standard is met.

Parts of the system to be checked

Earth installation in operating conditions. The test must be performed without disconnecting the earth rods.

Allowable values

The value of earth resistance, however measured, must satisfy the following relation:

$$R_A < 50 / I_a$$

where: R_A = resistance measured of earth installation whose value can be determined with the following measurements:

- Three-wire earth resistance with voltammetric method
- Impedance of the fault ring (*)
- Earth resistance with two wires (**)
- Earth resistance with two wires in socket (**)
- Earth resistance obtained by the measurement of contact voltage U_t (**)
- Earth resistance obtained by the tripping time test of the RCDs (A, AC, B), RCD S (A, AC) (**)

I_a = tripping current of the automatic RCD or rated tripping current of the RCD (in case of RCD S 2 I_{dN}) in ampere

50 = safety limit voltage (reduced down to 25V in special environments)

(*) If the system protection is obtained through a differential switch, the measurement must be performed upstream of this switch or downstream of it by short-circuiting the switch in order to prevent it from tripping.

(**) These methods, although not currently foreseen by guidelines provide values that have been proven indicative of the earth resistance by numerous comparisons with the three-wire method.

EXAMPLE OF EARTH RESISTANCE CHECK

System protected by a 30mA differential switch.

- Let us measure the earth resistance by using one of the above-mentioned methods.
- In order to understand if the system resistance is to be considered as compliant with the standards, we need to multiply the value found by 0.03A (30mA).
- If the result is lower than 50V (or 25V for special environments), the system can be considered as coordinated, as it satisfies the relationship indicated above.
- When dealing with 30mA differential switches (as in almost all civil systems), the maximum allowable earth resistance is $50/0.03=1666\Omega$. This enables using also the indicated simplified methods which, although they do not provide an extremely precise value, provide a sufficiently approximated value for coordination calculation.

13.8. VERIFY OF PROTECTION AGAINST INDIRECT CONTACTS IN IT SYSTEMS

In IT systems the active parts must be isolated from the ground or be connected to earth through an impedance of sufficiently high value. In the case of a single earth fault current of the first fault is weak and therefore it is not necessary to interrupt the circuit. This connection can be made to the neutral point of the system or to an artificial neutral point. If there is no neutral point, can be connected to earth through an impedance of a line conductor. It must, however, take precautions to avoid the risk of harmful physiological effects on people in contact with conductive parts simultaneously accessible in the case of a double earth fault.

Purpose of the test

Verify that the impedance of the ground probe in which the mass are connected satisfy the following relationship:

$$Z_E * I_d \leq U_L$$

where:

- Z_E = L-PE impedance of the ground probe in which the mass are connected
- I_d = L-PE current of first fault (typically expressed in mA)
- U_L = Limit contact voltage 25V or 50V

Parts of the system to be checked

The earth system under operating conditions. The verification should be performed without disconnecting the ground probes.

13.9. VERIFY OF PROTECTION COORDINATION L-L, L-N AND L-PE

Purpose of the test

Test the coordination of protective devices (typically MCB or fuse) present in a Single-phase or Three-phase installation as a function of the limit time of fault extinction by the protection set by the user and the calculated value of the short-circuit current.

Parts of the system to be checked

The test must be performed at the point in which the minimum short-circuit current is possible, normally at the end of the line controlled by the protection device in the normal condition of the line. The test must be performed between Phase-Phase in the Three-phase installations and between Phase-PE or Phase-PE in the Single-phase installation

Allowable values

The instrument performs the comparison between the calculated value of short-circuit current and the I_a = tripping current of the protection device within the specified time, according to the following expressions:

$$I_{SCL-L_Min2\Phi} > I_a \quad \text{Three-phase system} \rightarrow \text{Loop L-L impedance}$$

$$I_{SCL-N_Min} > I_a \quad \text{Single-phase system} \rightarrow \text{Loop L-N impedance}$$

$$I_{SCL-PE_Min} > I_a \quad \text{Single-phase system} \rightarrow \text{Loop L-PE impedance}$$

where:

- Isc L-L_Min2F = Prospective short-circuit current minimum double phase L-L
- Isc L-N_Min = Prospective short-circuit current minimum L-N
- Isc L-PE_Min = Prospective short-circuit current minimum L-PE

The calculation of prospective short-circuit current is performed by the instrument based on the fault loop impedance measurement in compliance with the following relationships derived from standard EN60909-0:

$$I_{SCL-L_Min2\Phi} = C_{MIN} \cdot \frac{U_{L-L}^{NOM}}{Z_{L-L}} \quad I_{SCL-N_Min} = C_{MIN} \cdot \frac{U_{L-N}^{NOM}}{Z_{L-N}} \quad I_{SCL-PE_Min} = C_{MIN} \cdot \frac{U_{L-PE}^{NOM}}{Z_{L-PE}}$$

Phase – Phase

Phase – Neutral

Phase – PE

Measured voltage	U_{NOM}	C_{MIN}
$230V-10\% < V_{measured} < 230V+ 10\%$	230V	0,95
$230V+10\% < V_{measured} < 400V- 10\%$	$V_{measured}$	1,00
$400V-10\% < V_{measured} < 400V+ 10\%$	400V	0,95

where:

- U L-L = Nominal Phase-Phase voltage
- U L-N = Nominal Phase-Neutral voltage
- U L-PE = Nominal Phase-PE voltage
- Z L-L = Impedance Phase-Phase measured
- Z L-N = Impedance Phase-Neutral measured
- Z L-PE = Impedance Phase-PE measured

CAUTION



The instrument must be used to measure fault loop impedance values at least 10 times higher than the resolution value of the instrument in order to minimize errors.

Depending on the set values of nominal voltage (see § 5.1.4) and the measured value of fault loop impedance, the instrument calculates the **minimum value** of the assumed short-circuit current to be interrupted by the protection device. For proper coordination, this value **MUST** always be greater than or equal to the **I_a** value of the tripping current of the type of protection considered.

The **I_a** reference value depends on:

- Protection type (curve)
- Rated current of the protection device
- Time of fault extinction by the protection

The instrument allows the selection (*) of the following parameters:

- MCB current (B curve) selectable among values: **6, 10, 13, 15, 16, 20, 25, 32, 40, 50, 63A**
- MCB current (C, K curves) selectable among values: **0.5, 1, 1.6, 2, 4, 6, 10, 13, 15, 16, 20, 25, 32, 40, 50, 63A**
- MCB current (D curve) selectable among values: **0.5, 1, 1.6, 2, 4, 6, 10, 13, 15, 16, 20, 25, 32A**
- Nominal current Fuse gG selectable among values: **2, 4, 6, 8, 10, 12, 13, 16, 20, 25, 32, 40, 50, 63, 80, 100, 125, 160, 200, 250, 315, 400, 500, 630, 800, 1000, 1250A**
- Nominal current Fuse aM selectable among values: **2, 4, 6, 8, 10, 12, 16, 20, 25, 32, 40, 50, 63, 80, 100, 125, 160, 200, 250, 315, 400, 500, 630A**
- Time of fault extinction by the protection selectable among: **0.1s, 0.2s, 0.4s, 1s, 5s**

(*) The values could be subject to variations

13.10. VERIFY OF THE PROTECTION AGAINST SHORT CIRCUITS – TEST I²T

The I²t parameter represents the specific energy (expressed in A²s) let through by the protective device in short-circuit condition.

The I²t energy must be able to be supported both by the cables and by the distribution bars. For cables, the following relation applies:

$$(K * S)^2 \geq I^2 t \quad (1)$$

where:

- S = section of the protective conductor in mm²
 K = constant dependent on the material of the protective conductor, on the type of insulation and the temperature that can be obtained from the tables present in the standards (the instrument refers to a fixed environment temperature of 25°C, single cable not buried, no harmonics).

Starting from the evaluation of the three-phase or single-phase **I_{sc} short-circuit current**, the instrument calculates the maximum value of I²t parameter on the basis of the characteristic curves of the selected protection (MCB or fuse), and runs the comparison with the previous relation (1).

If the test gives a positive result, the **selected section** of the protective conductor is adequate for the management of the protective device chosen. In case of negative result, it is not necessary to select a higher value than the section or change the protection.

The following selections (*) are available on the instrument:

- Magnetothermal protection (MCB) with curves **B, C, K, D**
- Protection with fuse of type **aM** and **gG**
- MCB Rated current selectable among:
0.5A, 1A, 1.6A, 2A, 4A, 6A, 10A, 13A, 15A, 16A, 20A, 25A, 32A, 40A, 50A, 63A
- Fuse rated current selectable among:
2A, 4A, 6A, 8A, 10A, 12A, 13A, 16A, 20A, 25A, 32A, 40A, 50A, 63A, 80A, 100A, 125A, 160A, 200A, 250A, 315A, 400A, 500A, 630A, 800A, 1000A, 1250A
- Conductor material: selectable between **Cu** (Copper) and **Al** (Aluminum)
- Conductor insulation: selectable among **PVC**, **Rub/Butil** (Rubber/Butyl rubber) and **EPR/XLPE** (Ethylene propylene rubber/Cross-linked polyethylene)
- Conductor section free selectable and possible number of parallel cords (max 99)

(*) The values could be subject to variations



CAUTION

The verifies made by the instrument does not replace in any case the design calculations

13.11. VERIFICATION OF VOLTAGE DROP ON MAIN LINES

Measurement voltage drop as a result of current flow through a main line or a part of it can be very important if it is necessary:

- Verify the capability of an existing main line to supply a load
- Dimension a new installation
- Search for possible causes of troubles on devices, loads, etc.. connected to a main line

Purpose of the test

Measure the maximum percentage value of voltage drop between two points of a main line

Parts of the system to be checked

The test includes two sequential impedance measurements in the initial point of main power line (typically downstream to a protection device) and in the final point of the same line.

Allowable values

The instruments compares the calculated value of $\Delta V\%$ maximum voltage drop to the set limit value (according to applicable guidelines) according to the following relationship:

$$\Delta V\%_{MAX} = \frac{(Z_2 - Z_1) * I_{NOM}}{V_{NOM}} * 100$$

where:

- Z_2 = End point impedance of the main line being tested
- Z_1 = Initial point impedance (Offset) of the main line being tested ($Z_2 > Z_1$)
- I_{NOM} = Nominal current of protection device of the main line being tested
- V_{NOM} = Phase-Neutral or Phase-PE nominal voltage of the main line being tested

13.12. MEASUREMENT OF EARTH RESISTANCE IN TN SYSTEMS

Purpose of the test

Check that the measured value of earth resistance is lower than the maximum limit calculated on the basis of the maximum allowable contact voltage **U_{tp}** for the system.

In accordance with the requirements of standard EN50522 (for USA, Germany and Extra Europe countries refer to the respective guidelines) the maximum allowable contact voltage is dependent on the time duration of the fault according to the following Table 6

Fault duration [s]	Allowed contact voltage U _{tp} [V]
10	85
5.00	86
2.00	96
1.00	117
0.50	220
0.20	537
0.10	654
0.05	716

Table 6 Maximum allowable values for contact voltage

Allowable values

The maximum earth resistance is calculated using the following relation:

$$R_t \leq \frac{U_{tp}}{I_g}$$

where:

- U_{tp} = maximum allowable contact voltage in the system on the basis of the value of U_{tp} (the values not included in Table 6 are obtained by linear interpolation) according to the duration time of the fault (value provided by the Energy distribution board)
- I_g = maximum fault current in the system (value provided by the Energy distribution board)

On the instrument, it is possible to select the value of the time duration of the fault in the range between **0.04s** and **10s** and the value of the fault current in the range between **1A** and **9999A**.

Measurement of earth impedance by voltammetric method

Creating cables extensions

If the length of the cables supplied with the instrument is not enough, you can create your own extensions to carry out the measurements in the system without influencing the instrument accuracy and, by the nature of the voltammetric method, **without the need to perform any compensation of measuring cable resistance**.

To create extensions, always adopt the following guidelines to ensure the safety of the operator:

- Always use cables characterized by insulation voltage and insulation class appropriate to the rated voltage and measurement category (overvoltage) of the system under consideration.
- For extension terminals, always use connectors having measurement category (overvoltage) and voltage appropriate for the point where you plan to connect the instrument (see § 1.4). The use of the optional accessories **1066-IECN** (black) and **1066-IECR** (red) is recommended.

Method for small-sized earth networks

Let a current stream between the earth network under test and an auxiliary rod placed at a distance equal to **fivefold the diagonal of the area limiting the earth installation itself** (see Fig. 52). Place the voltage probe at approximately half way between the earth rod and the current probe, finally measure the voltage between them.

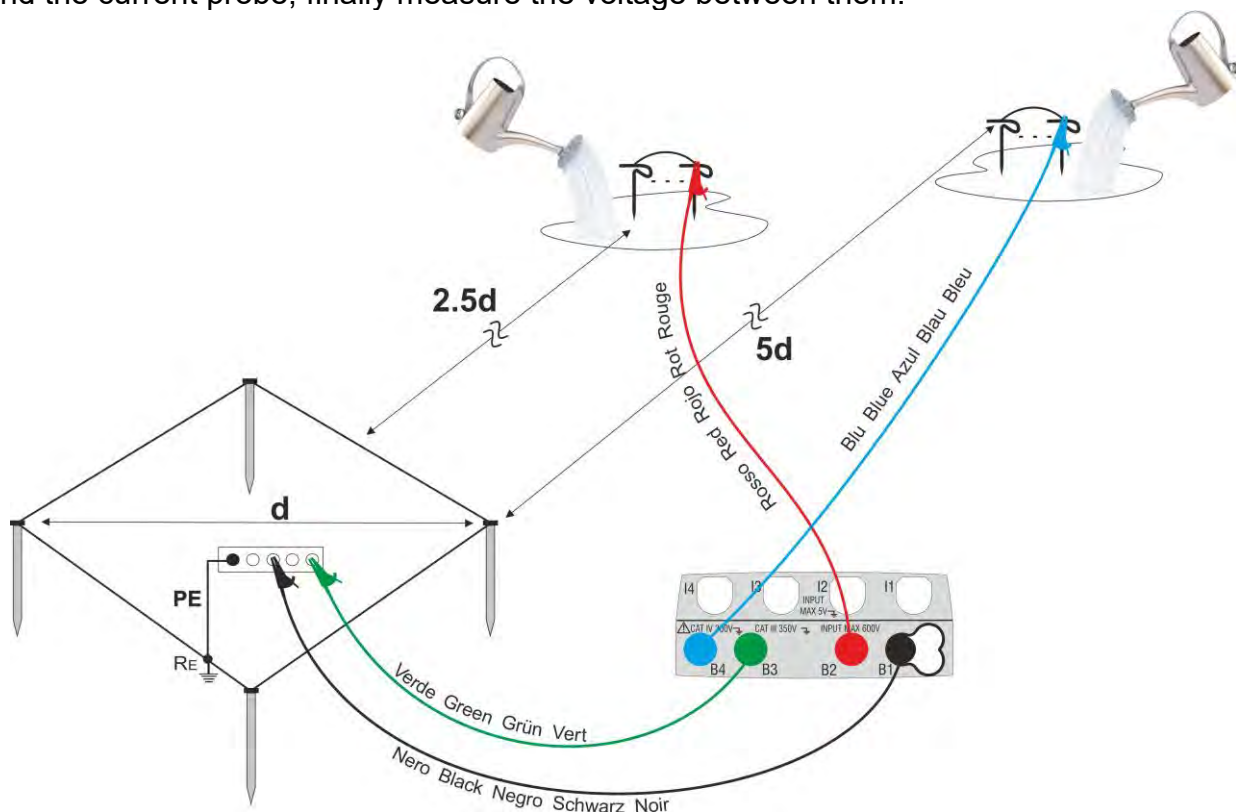

Fig. 52: Ground measurement for small-sized earth networks

If needed, use multiple probes in parallel and wet the surrounding ground (see Fig. 52) if the instrument is not able to supply the current required to perform the test due to a high resistance of the ground.

Big-sized earth networks

This technique is always based on the voltammetric method and is used where it is difficult to position the auxiliary earth current rod at a distance equal to 5 times the diagonal of the area of the ground system **by reducing this distance to once the diagonal of the ground system** (see Fig. 53).

To confirm that the voltage probe is located outside the zone of influence of the system under test and the auxiliary earth rod, it is necessary to perform several measurements by initially placing the voltage probe at the midpoint between the system and the auxiliary current rod, then moving the probe both to the system under consideration and to the auxiliary current rod.

These measurements should provide compatible results, any significant differences between the various measured values indicate that the voltage probe has been stuck within the zone of influence of the system under test or the auxiliary current rod. Such measurements cannot be considered as reliable. It is necessary to further extend the distance between the auxiliary current rod and the rod under test, then repeat the whole procedure as above described.

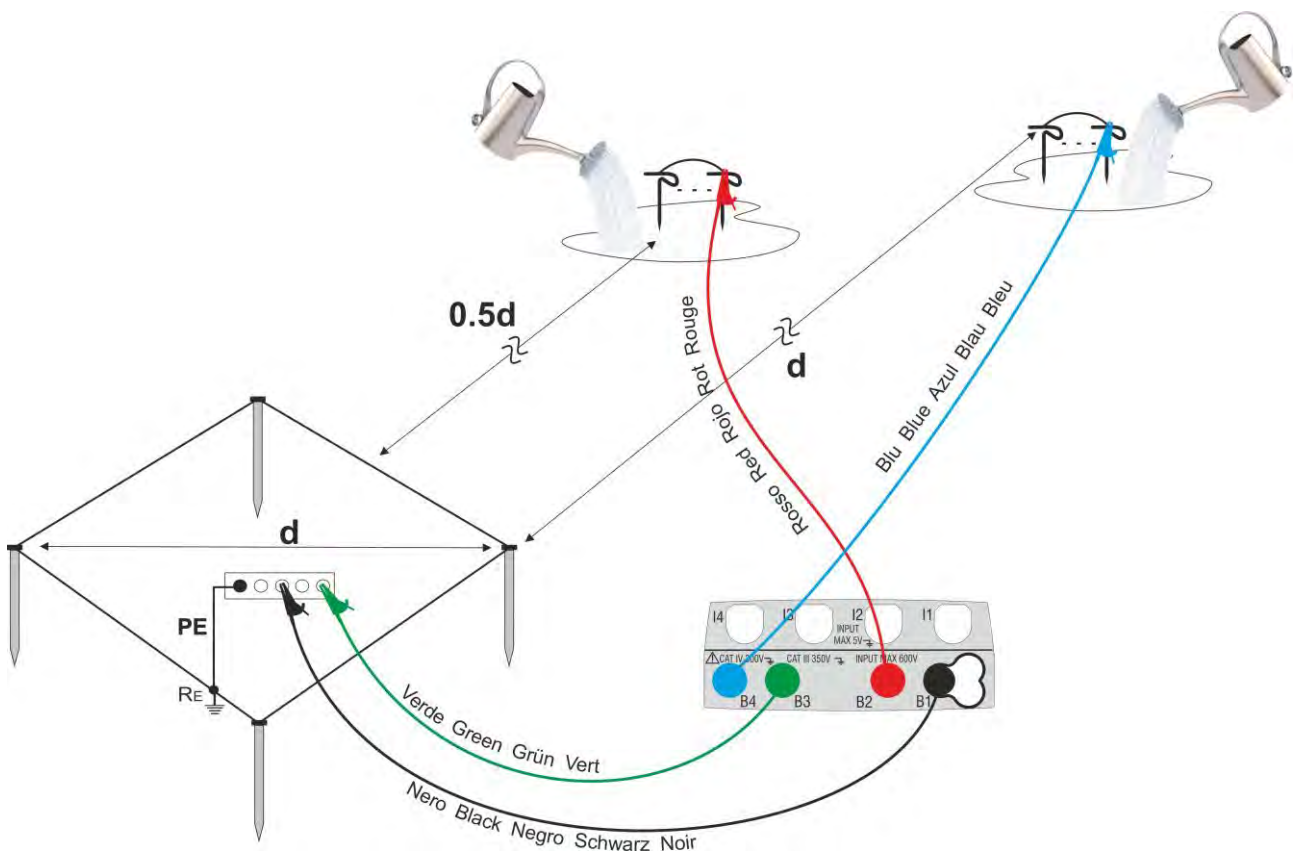

Fig. 53: Ground measurement for big-sized earth networks

Use multiple probes in parallel and wet the surrounding ground (see Fig. 53) if the instrument is not able to supply the current required to perform the test due to a high resistance of the ground.

Ground resistivity measurement

This test aims at analyzing the resistivity value of the ground in order to define the type of rods to be used when designing the installation. For the measurement of resistivity, there are no correct or incorrect values. The various values obtained using distances between increasing "d" rods should be reported in a graph from which, according to the curve obtained, it is possible to determine the type of rods to use. As the test result can be affected by metal parts buried such as pipes, cables or other rods etc., it is advisable to take a second measurement positioning the rods at an equal distance "d", but rotating their axis by 90° (see Fig. 54).

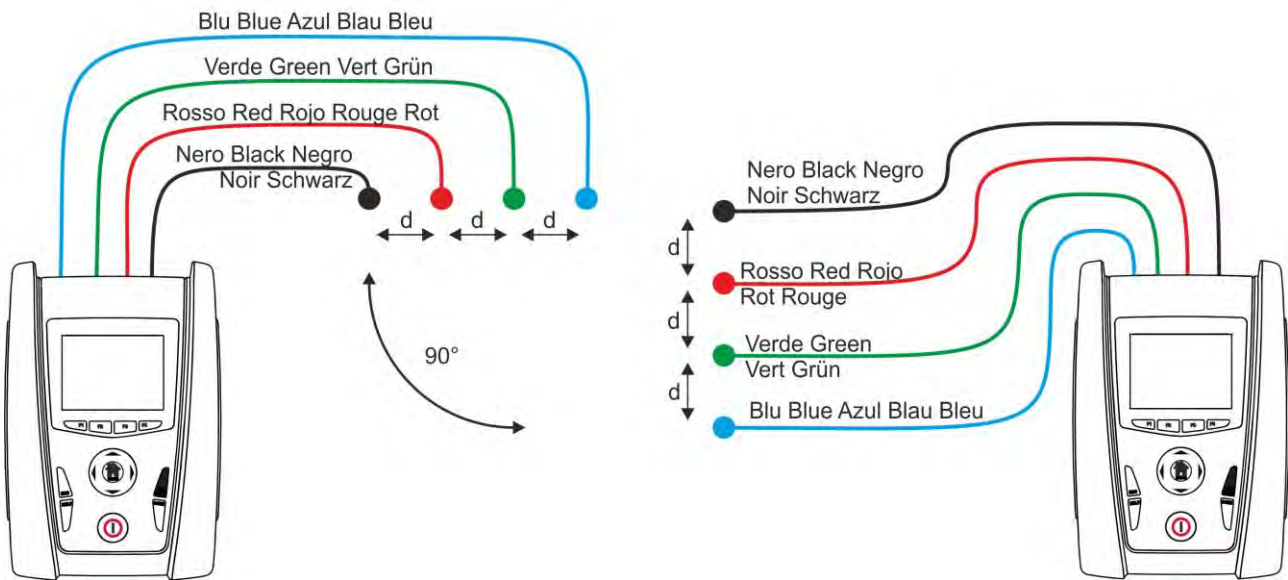
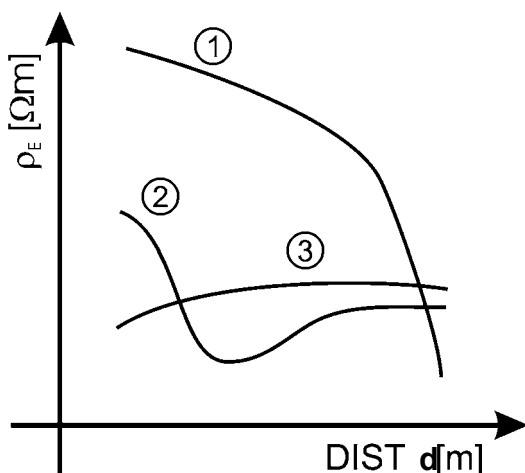

Fig. 54: Ground resistivity measurement

The resistivity value is given by the following relation: $\rho_E = 2 \pi d R$ where:

- ρ_E = specific ground resistivity
- d = distance between the probes [m]
- R = resistance measured by the instrument [Ω]

The measuring method allows defining the specific resistivity of a ground layer up to the depth corresponding approximately to the distance "d" between the two rods. If you increase the distance "d", you can reach deeper ground layers and check the ground homogeneity. After several measurements you can trace a profile according to which the most suitable rod is chosen.



- Curve 1:** as ρ_E decreases only in depth, it is advisable to use a very deep rod
- Curve 2:** as ρ_E decreases only until the depth d it is not useful to increase the depth of the rods beyond a
- Curve 3:** the ground resistivity is quite constant, so increasing depth does not make ρ_E decrease, therefore a ring rod must be used.

Fig. 55: Ground resistivity measurement

Approximate evaluation of intentional rods' contribution

The resistance of an Rd rod can be calculated with the following formulas (ρ r = average resistivity of the ground).

a) resistance of a vertical rod

$$R_d = \rho / L$$

where L = length of the element touching the ground

b) resistance of a horizontal rod

$$R_d = 2\rho / L$$

where L = length of the element touching the ground

c) resistance of linked elements

The resistance of a complex system made of more elements in parallel is always higher than the resistance, which could result from a simple calculation of single elements in parallel, especially if those elements are close to each other and therefore interactive. For this reason, in case of a linked system the following formula is quicker and more effective than the calculation of the single horizontal and vertical elements:

$$R_d = \rho / 4r$$

where r = radius of the circle which circumscribes the link

13.13. VOLTAGE ANOMALIES

The meter is capable of recording **independently by the aggregation time** all those TRMS values as voltage anomalies (sags, swells), calculated every 20ms, beyond the percentage thresholds of Voltage Reference (Vref) set during the programming from $\pm 3\%$ to $\pm 30\%$ with steps of 1% . These limits remain unchanged throughout the recording period. The reference are set to:

Nominal Voltage Phase to Neutral: For Single Phase and 4 wires three phase system.
 Nominal Voltage Phase to Phase: For 3 wires three phase and ARON system

Example1 → Three Phase 3 wires

Vref = 400V, LIM+= 10%, LIM-=10% =>

High Lim = $400 * [1+(10/100)] = 440V$

Low Lim = $400 * [1-(10/100)] = 360V$

Example2 → Three Phase 4 wires.

Vref = 230V, LIM+= 10%, LIM-=10% =>

High Lim = $230 * [1+(10/100)] = 253V$

Low Lim = $230 * [1-(10/100)] = 207V$

For each event the instrument records (**with visualization only by management software**):

- The number corresponding to the phase (L1, L2 or L3) where the event occurred
- The direction of the event: “UP” (sag) or “DN” (swell)
- The date/time of the event beginning
- The duration of the event, in seconds with a resolution of 20ms
- The minimum (or maximum) value of voltage during the event.

13.14. VOLTAGE AND CURRENT HARMONICS

Any periodical non-sine wave can be represented as a sum of sinusoidal waves having each a frequency that corresponds to an entire multiple of the fundamental, according to the relation:

$$v(t) = V_0 + \sum_{k=1}^{\infty} V_k \sin(\omega_k t + \varphi_k) \quad (1)$$

where: V_0 = average value of $v(t)$
 V_1 = amplitude of the fundamental of $v(t)$
 V_k = amplitude of the k^{th} harmonic of $v(t)$

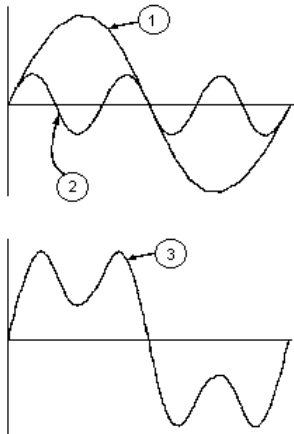

CAPTION:

1. Fundamental
2. Third harmonic
3. Distorted waveform

Fig. 56: Effect of the sum of two multiple frequencies

In the mains voltage, the fundamental has a frequency of 50 Hz, the second harmonic has a frequency of 100 Hz, the third harmonic has a frequency of 150 Hz and so on. Harmonic distortion is a constant problem and should not be confused with short events such as sags, surges or fluctuations.

It can be noted that in (1) the index of the sigma is from 1 to the infinite. What happens in reality is that a signal does not have an unlimited number of harmonics: a number always exists after which the harmonics value is negligible. The EN 50160 standard recommends to stop the index in the expression (1) in correspondence of the 40th harmonic. A fundamental element to detect the presence of harmonics is THD defined as:

$$THD_v = \frac{\sqrt{\sum_{h=2}^{40} V_h^2}}{V_1}$$

This index takes all the harmonics into account. The higher it is, the more distorted the waveform gets.

Limit values for harmonics

EN 50160 guideline fixes the limits for the harmonic voltages, which can be introduced into the network by the power supplier. In normal conditions, during whatever period of a week, 95% of the RMS value of each harmonic voltage, mediated on 10 minutes, will have to be inferior than or equal to the values stated in Table 7. The total harmonic distortion (THD) of the supply voltage (including all the harmonics up to 40th order) must be inferior than or equal to 8%.

Odd harmonics				Even harmonics	
Not multiple of 3		Multiple of 3		Order h	Relative voltage % Max
Order h	Relative voltage % Max	Order h	Relative voltage % Max		
5	6	3	5	2	2
7	5	9	1,5	4	1
11	3,5	15	0,5	6..24	0,5
13	3	21	0,5		
17	2				
19	1,5				
23	1,5				
25	1,5				

Table 7 Limits for the harmonic voltages the supplier may introduce into the network

These limits, theoretically applicable only for the supplier of electric energy, provide however a series of reference values within which the harmonics introduced into the network by the users must be contained.

Presence of harmonics: causes

- Any apparatus that alters the sine wave or uses only a part of such a wave causes distortions to the sine wave and therefore harmonics. All current signals result in some way virtually distorted. The most common situation is the harmonic distortion caused by non-linear loads such as electric household appliances, personal computers or speed control units for motors. Harmonic distortion causes significant currents at frequencies that are odd multiples of the fundamental frequency. Harmonic currents affect considerably the neutral wire of electric installations.
- In most countries, the mains power is three-phase 50/60Hz with a delta primary and star secondary transformers. The secondary generally provides 230V AC from phase to neutral and 400V AC from phase to phase. Balancing the loads on each phase has always represented an headache for electric systems designers
- Until some ten years ago, in a balanced system, the vectorial sum of the currents in the neutral was zero or quite low (given the difficulty of obtaining a perfect balance). The devices were incandescent lights, small motors and other devices that presented linear loads. The result was an essentially sinusoidal current in each phase and a low current on the neutral at a frequency of 50/60Hz
- “Modern” devices such as TV sets, fluorescent lights, video machines and microwave ovens normally draw current for only a fraction of each cycle thus causing non-linear loads and subsequent non-linear currents. All this generates odd harmonics of the 50/60Hz line frequency. For this reason, the current in the transformers of the distribution boxes contains only a 50Hz (or 60Hz) component but also a 150Hz (or 180Hz) component, a 50Hz (or 300Hz) component and other significant components of harmonic up to 750Hz (or 900Hz) and higher
- The vectorial sum of the currents in a balanced system that feeds non-linear loads may still be quite low. However, the sum does not eliminate all current harmonics. The odd multiples of the third harmonic (called “TRIPLENS”) are added together in the neutral and can cause overheating even with balanced loads.

Presence of harmonics: consequences

In general, even harmonics, i.e. the 2nd, 4th etc., do not cause problems. Triple harmonics, odd multiples of three, are added on the neutral (instead of cancelling each other) thus creating a condition of overheating of the wire which is extremely dangerous. Designers should take into consideration the three issues given below when designing a power distribution system that will contain harmonic current:

- The neutral wire must be of sufficient gauge
- The distribution transformer must have an additional cooling system to continue operating at its rated capacity when not suited to the harmonics. This is necessary because the harmonic current in the neutral wire of the secondary circuit circulates in the delta-connected primary circuit. This circulating harmonic current heats up the transformer
- Phase harmonic currents are reflected on the primary circuit and continue back to the power source. This can cause distortion of the voltage wave so that any power factor correction capacitors on the line can be easily overloaded.

The 5th and the 11th harmonic contrast the current flow through the motors making its operation harder and shortening their average life. In general, the higher the ordinal harmonic number, the smaller its energy is and therefore the impact it will have on the devices (except for transformers).

13.15. DEFINITIONS OF POWERS AND POWER FACTORS

In a standard electrical installation powered by three sine voltages the following are to be defined:

Phase Active Power:	(n=1,2,3)	$P_n = V_{nN} \cdot I_n \cdot \cos(\varphi_n)$
Phase Apparent Power:	(n=1,2,3)	$S_n = V_{nN} \cdot I_n$
Phase Reactive Power:	(n=1,2,3)	$Q_n = \sqrt{S_n^2 - P_n^2}$
Phase Power Factor:	(n=1,2,3)	$P_{Fn} = \frac{P_n}{S_n}$
Total Active Power:		$P_{TOT} = P_1 + P_2 + P_3$
Total Reactive Power:		$Q_{TOT} = Q_1 + Q_2 + Q_3$
Total Apparent Power:		$S_{TOT} = \sqrt{P_{TOT}^2 + Q_{TOT}^2}$
Total Power Factor:		$P_{FTOT} = \frac{P_{TOT}}{S_{TOT}}$

where:

V_{nN} = RMS value of voltage between phase n and Neutral.

I_n = RMS value of n phase current.

φ_n = Phase angle between voltage and current of n phase.

In the presence of distorted voltages and currents the previous relations vary as follows:

Phase Active Power:	(n=1,2,3)	$P_{actn} = \sum_{k=0}^{\infty} V_{kn} I_{kn} \cos(\varphi_{kn})$
Phase Apparent Power:	(n=1,2,3)	$P_{appn} = V_{nN} \cdot I_n$
Phase Reactive Power:	(n=1,2,3)	$P_{reactn} = \sqrt{P_{appn}^2 - P_{actn}^2}$
Phase Power Factor:	(n=1,2,3)	$P_{Fn} = \frac{P_{actn}}{P_{appn}}$
Distorted Power Factor	(n=1,2,3)	$dPF_n = \cos \varphi_{1n}$ = phase displacement between the fundamentals of voltage and current of n phase
Total Active Power:		$P_{act} = P_{act1} + P_{act2} + P_{act3}$
Total Reactive Power:		$P_{react} = P_{react1} + P_{react2} + P_{react3}$
Total Apparent Power:		$P_{app} = \sqrt{P_{act}^2 + P_{react}^2}$
Total Power Factor:		$P_F = \frac{P_{act}}{P_{app}}$

where:

V_{kn} = RMS value of kth voltage harmonic between n phase and Neutral.

I_{kn} = RMS value of kth current harmonic of n phase.

φ_{kn} = Phase displacement angle between kth voltage harmonic and kth current harmonic of n phase

NOTES

- It shall be noted that the expression of the phase Reactive Power **with no sine waveforms**, would be wrong. To understand this, it may be useful to consider that both the presence of harmonics and the presence of reactive power produce, among other effects, an increase of line power losses due to the increased current RMS value. With the above given relation the increasing of power losses due to harmonics is added to that introduced by the presence of reactive power. In effect, even if the two phenomena contribute together to the increase of power losses in line, it is not true generally that these causes of power losses are in phase between each other and therefore that can be summed mathematically
- The above given relation is justified by the relative simplicity of its calculation and by the relative discrepancy between the value obtained using this relation and the true value
- It shall also be noted, how, in case of an electric installation with harmonics, another parameter called displacement Power Factor (Cosphi) is defined. In practice, this parameter represents the theoretical limit value that can be reached for Power Factor if all the harmonics could be eliminated from the electric installation.

Conventions on powers and power factors

As for the recognition of the type of reactive power, of the type of power factor and of the direction of the active power, the below conventions must be applied. The stated angles are those of phase-displacement of the current compared to the voltage (for example, in the first panel the current is in advance from 0° to 90° compared to the voltage):

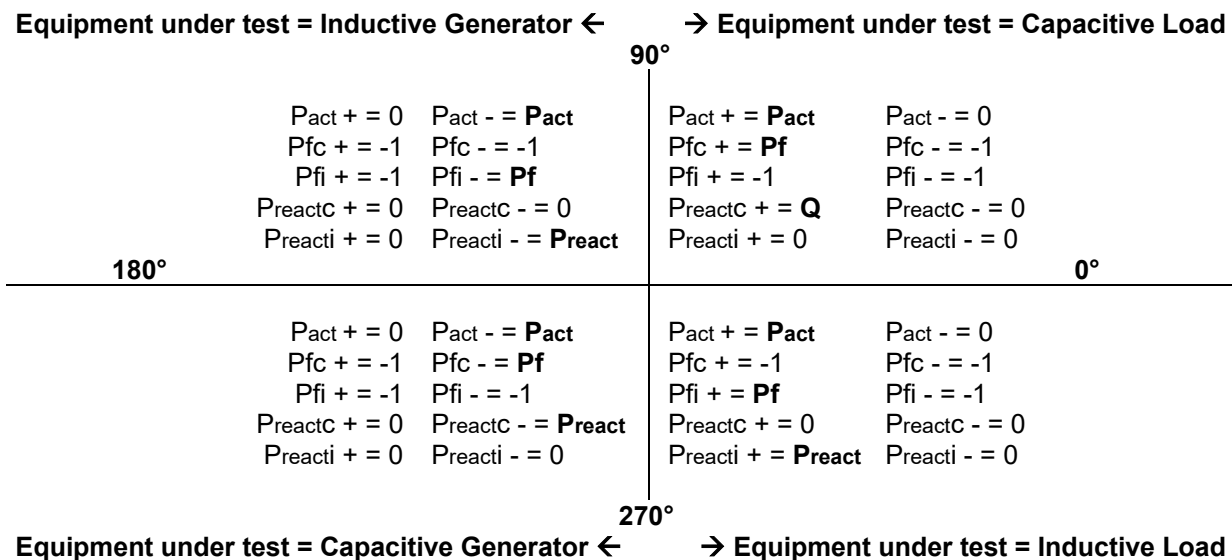

where:

Symbol	Description	Remarks
Pact+	Value of the active power +	Positive parameter (user)
Pfc+	Capacitive power factor +	
Pfi+	Inductive power factor +	
Preactc+	Value of the capacitive reactive power +	
Preacti+	Value of the inductive reactive power +	
Pact-	Value of the active power -	Negative parameter (generator)
Pfc-	Capacitive power factor -	
Pfi-	Inductive power factor -	
Preactc-	Value of the capacitive reactive power -	
Preacti-	Value of the inductive reactive power -	

Value	Description
Pact	The active power (positive or negative) is defined in the panel and therefore acquires the value of the active power in that moment.
Preact	The reactive power (inductive or capacitive, positive or negative) is defined in the panel and therefore acquires the value of the reactive power in that moment.
Pf	The power factor (inductive or capacitive, positive or negative) is defined in the panel and therefore acquires the value of the power factor in that moment.
0	The active power (positive or negative) or the reactive power (inductive or capacitive, positive or negative) is NOT defined in the panel and therefore acquires a null value.
-1	The power factor (inductive or capacitive, positive or negative) is NOT defined in the panel.

Three phase 3 wire ARON system

In the electrical systems distributed without neutral, the phase voltages and the power factors and phase $\cos\phi$ lose importance. Only the phase to phase voltages, the phase currents and the total powers remain defined.

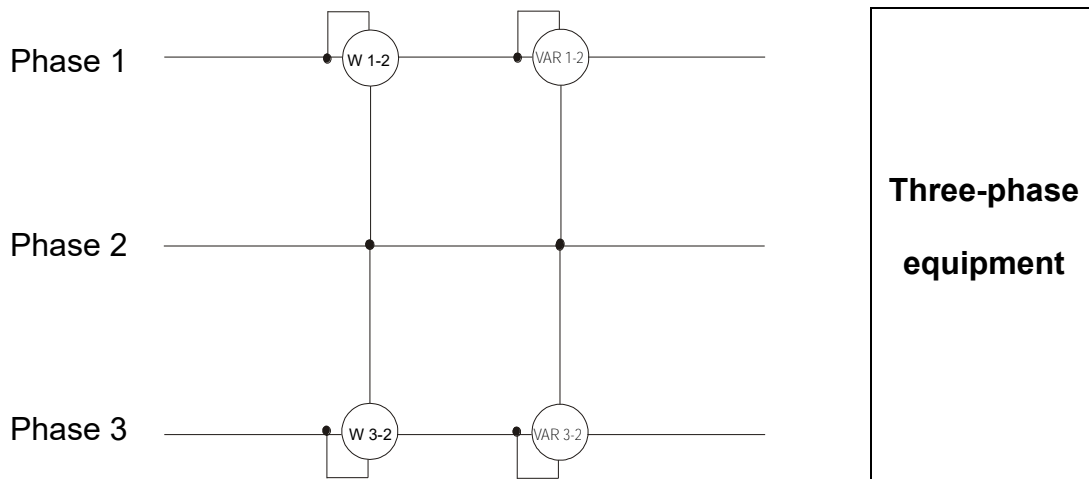

In this case the potential of one of the three phases (for example, phase 2) is taken on as reference potential. The total values of the active, reactive and apparent power are expressed as sum of the indications of the couples of Wattmeters, VARmeters and VAmeters.

$$P_{act} = P_{act12} + P_{act32}$$

$$P_{react} = P_{react12} + P_{react32}$$

$$P_{app} = \sqrt{(P_{act12} + P_{act32})^2 + (P_{react12} + P_{react32})^2}$$

13.16. MEASURING METHOD: OUTLINES

The meter is capable of measuring: voltages, currents, active powers, inductive and capacitive reactive powers, apparent powers, inductive and capacitive power factors, energies, analogical or pulse parameters. All these parameters are analysed in a digital way for each phase (voltage and current) and calculated based on formulas of the previous sections.

Aggregation time

The storage of all the data would require a huge memory capacity. Therefore we've tried to find out a storage method which permits to compress the information to be saved providing significant data. The selected method is the integration one: after a certain period called "**aggregation time**", which can be set from **2 seconds to 30 minutes**, the meter extracts from the sampled values the following values:

- MINIMUM value of the parameter during the aggregation time (harmonics excluded).
- AVERAGE value of the parameter (intended as arithmetic average of all the values recorded during the aggregation time).
- MAXIMUM value of the parameter during the aggregation time (harmonics excluded).

Only this information (repeated for each parameter to be stored) are saved in the memory along with starting time and date of the aggregation time. Once these data are stored, the instrument restarts to take measurements for a new interval.

13.17. DESCRIPTION OF TYPICAL CONFIGURATIONS

During each recording, **as a not modifiable option**, the instrument always automatically saves, as a standard configuration, besides voltage anomalies, the values of any network parameter depending on the type of selected electric system (see 6.10.1).

The meter allows defining the following typical configurations which can be selected at any moment (see § 6.10.2). The selection of one of these configurations automatically sets **only the necessary** parameters for recording depending on the type of analysis

EN50160	Setting parameters for quality network compliance with guideline EN50160 (see § 13.14)
HARM.	Setting parameters for voltage/current harmonic analysis (see § 13.14)
kWh (Power and Energy)	Setting parameters for Power/Energy measurements (see § 13.15)
DEFAULT	Setting default configuration (all possible recording parameters)

The parameters selected for recording in each of the typical configurations, depending on the type of selected electric system are listed below.

Three-phase system **3φ-4WIRES**, **3φ-3WIRES** and Single-phase **1φ-2WIRES**

EN50160	
Description	Settings
System type:	Not modified
Frequency:	Not modified
Clamp type:	Not modified
Full scale clamp:	Not modified
TV ratio:	Not modified
Start recording:	Not modified
Stop recording:	Not modified
Aggregation time:	10min
Harmonic s recording:	Selected
Voltage anomalies recordings:	Selected
Reference voltage anomalies (Vn):	Not modified
High threshold limit for voltage anomalies:	10%Vn
Low threshold limit for voltage anomalies:	10%Vn
Selected voltage:	V1(Single); V12,V32,V31(3-wires); V1,V2,V3 (4-wires)
Voltage harmonics:	THD%,DC,01,02... 49
Voltage unbalance:	Rev%, Zero% (4-wires), Rev% (3-wires)
Voltage frequency:	Selected
Current, powers, energie, power factors:	Not selected

Table 8: List of parameters saved in EN50160 typical configuration

HARM	
Description	Settings
System type:	Not modified
Frequency:	Not modified
Clamp type:	Not modified
Full scale clamp:	Not modified
TV ratio:	Not modified
Start recording:	Not modified
Stop recording:	Not modified
Aggregation time:	10min
Voltage anomalies recordings:	Selected
Reference voltage anomalies (Vn):	Not modified
High threshold limit for voltage anomalies:	Not modified
Low threshold limit for voltage anomalies:	Not modified
Harmonic s recording:	Selected
Selected voltage:	V1(Single); V12,V32,V31(3-wires); V1,V2,V3 (4-wires)
Voltage harmonics::	THD%,DC,01,02... 49
Voltage unbalance:	Not selected
Voltage frequency:	Selected
Selected current	I1 (Single); I1,I2,I3 (3-wires); I1,I2,I3,In (4-wires)
Current harmonics:	THD%,DC,01,02... 49
Powers, energie, power factors:	Not selected

Table 9: List of parameters saved in HARMONICS typical configuration

kWh (POWER & ENERGY)	
Description	Settings
System type:	Not modified
Frequency:	Not modified
Clamp type:	Not modified
Full scale clamp:	Not modified
TV ratio:	Not modified
Start recording:	Not modified
Stop recording:	Not modified
Aggregation time:	15min
Voltage anomalies recordings:	Selected
Reference voltage anomalies (Vn):	Not modified
High threshold limit for voltage anomalies:	Not modified
Low threshold limit for voltage anomalies:	Not modified
Harmonic s recording:	Not selected
Selected voltage:	V1(Single); V12,V32,V31(3-wires); V1,V2,V3 (4-wires)
Voltage frequency:	Selected
Voltage unbalance:	Not selected
Selected current	I1 (Single); I1,I2,I3 (3-wires); I1,I2,I3,In (4-wires)
Selected powers	P1+, P1-, Q1i+, Q1i-, Q1c+, Q1c-, S1+, S1- (Single)
	Pt+, Pt-, P1+, P1-, P2+, P2-,P3+, P3- Qti+, Qti-,Qtc+,Qtc-,Q1i+, Q1i-,Q1c+,Q1c-,Q2i+,Q2i-,Q2c+,Q2c-,Q3i+,Q3i-,Q3c+,Q3c- St+,St-, S1+, S1-,S2+,S2-,S3+,S3- (3-wire, 4-wires)
Selected energies	Ea1+, Ea1-, Er1i+,Er1i-,Er1c+,Er1c-,Es1+,Es1- (Single)
	Eat+, Eat-, Ea1+, Ea1-, Ea2+, Ea2-,Ea3+, Ea3- Erti+, Erti- Ertc+,Ertc-,Er1i+,Er1i-,Er1c+,Er1c-,Er2i+,Er2i-,Er2c+,Er2c- Er3i+,Er3i-,Er3c+,Er3c- Est+,Est-,Es1+, Es1-,Es2+,Es2- Es3+,Es3- (3-wires, 4-wires)
Selected power factors, cosφ	Pf1i+,Pf1i-,Pf1c+,Pf1c-,dPf1i+,dPf1i-,dPf1c+,dPf1c- (Single)
	Pfti+,Pfti-,Pftc+,Pftc-,Pf1i+,Pf1i-,Pf1c+,Pftc-,Pf2i+,Pf2i- Pf2c+,Pf2c-,Pf3i+,Pf3i-,Pf3c+,Pf3c-,dPfti+,dPfti-,dPftc+,dPftc- dPf1i+,dPf1i-,dPf2c+,dPf2c-,dPf3i+,dPf3i-,dPf3c+,dPf3c- (3-wires, 4-wires)

Table 10: List of parameters saved in POWER&ENERGY typical configuration

DEFAULT	
Description	Settings
System type:	Not modified
Frequency:	Not modified
Clamp type:	Not modified
Full scale clamp:	Not modified
TV ratio:	Not modified
Start recording:	Not modified
Stop recording:	Not modified
Aggregation time:	Not modified
Voltage anomalies recordings:	Selezionata
Reference voltage anomalies (Vn):	Not modified
High threshold limit for voltage anomalies:	Not modified
Low threshold limit for voltage anomalies:	Not modified
Harmonic recording:	Selected
Selected voltage:	V1(Single); V12,V32,V31(3-wires); V1,V2,V3 (4-wires)
Voltage harmonics:	THD%,DC,01,02... 49
Voltage unbalance:	Rev%, Zero% (4-wires), Rev% (3-wires)
Voltage frequency:	Selected
Selected current	I1 (Single); I1,I2,I3 (3-wires); I1,I2,I3,In (4-wires)
Current harmonics	THD%,DC,01,02... 49
Selected powers	P1+, P1-, Q1i+, Q1i-, Q1c+, Q1c-, S1+, S1- (Single)
	Pt+, Pt-, P1+, P1-, P2+, P2-, P3+, P3-, Qti+, Qti-, Qtc+, Qtc-, Q1i+, Q1i-, Q1c+, Q1c-, Q2i+, Q2i-, Q2c+, Q2c-, Q3i+, Q3i-, Q3c+, Q3c-, St+, St-, S1+, S1-, S2+, S2-, S3+, S3- (3-wire, 4-wires)
Selected energies	Ea1+, Ea1-, Er1i+, Er1i-, Er1c+, Er1c-, Es1+, Es1- (Single)
	Eat+, Eat-, Ea1+, Ea1-, Ea2+, Ea2-, Ea3+, Ea3-, Erti+, Erti-, Ertc+, Ertc-, Er1i+, Er1i-, Er1c+, Er1c-, Er2i+, Er2i-, Er2c+, Er2c-, Er3i+, Er3i-, Er3c+, Er3c-, Est+, Est-, Es1+, Es1-, Es2+, Es2-, Es3+, Es3- (3-wires, 4-wires)
Selected power factors, $\cos\phi$	Pf1i+, Pf1i-, Pf1c+, Pf1c-, dPf1i+, dPf1i-, dPf1c+, dPf1c- (Single)
	Pfti+, Pfti-, Pftc+, Pftc-, Pf1i+, Pf1i-, Pf1c+, Pftc-, Pf2i+, Pf2i-, Pf2c+, Pf2c-, Pf3i+, Pf3i-, Pf3c+, Pf3c-, dPfti+, dPfti-, dPftc+, dPftc-, dPf1i+, dPf1i-, dPf2c+, dPf2c-, dPf3i+, dPf3i-, dPf3c+, dPf3c- (3-wires, 4-wires)

Table 11: List of standard parameters saved in a DEFAULT typical configuration

Three-phase 4-wires 3 ϕ -High Leg systems – for USA systems

EN50160	
Description	Settings
System type:	Not modified
Frequency:	Not modified
Clamp type:	Not modified
Full scale clamp:	Not modified
TV ratio:	Not modified
Start recording:	Not modified
Stop recording:	Not modified
Aggregation time:	10min
Harmonic recording:	Selected
Voltage anomalies recording:	Selected
Reference voltage anomalies (Vn):	Not modified
High threshold limit for voltage anomalies:	10%Vn
Low threshold limit for voltage anomalies:	10%Vn
Selected voltage:	V1,V2,V3,V12,V32,V31
Voltage harmonics:	THD%,DC,01,02... 49
Voltage unbalance:	Rev%
Voltage frequency:	Selected
Selected current	Not selected
Selected powers	Not selected

Table 12: List of standard parameters saved in a EN50160 typical configuration

HARM.	
Description	Settings
System type:	Not modified
Frequency:	Not modified
Clamp type:	Not modified
Full scale clamp:	Not modified
TV ratio:	Not modified
Start recording:	Not modified
Stop recording:	Not modified
Aggregation time:	10min
Voltage anomalies recording:	Selected
Reference voltage anomalies (Vn)	Not modified
High threshold limit for voltage anomalies:	Not modified
Low threshold limit for voltage anomalies:	Not modified
Harmonic recording	Selected
Selected voltage:	V1,V2,V3, V12,V32,V31
Voltage harmonics:	THD%,DC,01,02... 49
Voltage unbalance:	Not selected
Voltage frequency:	Selected
Selected current	I1,I2,I3,In
Current harmonics:	THD%,DC,01,02... 49
Powers, Energie, power factors	Not selected

Table 13: List of parameters saved in HARMONICS typical configuration

kWh (POWER & ENERGY)	
Description	Description
System type:	Not modified
Frequency:	Not modified
Clamp type:	Not modified
Full scale clamp:	Not modified
TV ratio:	Not modified
Start recording:	Not modified
Stop recording:	Not modified
Aggregation time:	15min
Voltage anomalies recording:	Selected
Reference voltage anomalies (Vn)	Not modified
High threshold limit for voltage anomalies:	Not modified
Low threshold limit for voltage anomalies:	Not modified
Harmonic recording	Not selected
Selected voltage:	V1,V2,V3, V12,V32,V31
Voltage harmonics:	Selected
Voltage unbalance:	Not selected
Voltage frequency:	Selected
Selected current	I1,I2,I3,In
Selected powers	Pt+, Pt-, Qti+, Qti-,Qtc+,Qtc-,St+,St-
Selected energies	Eat+,Eat-,Erti+,Erti-,Ertc+,Ertc-
Selected power factors, cosφ	Pfti+,Pfti-,Pftc+,Pftc-,dPfti+,dPfti-,dPftc+,dPftc-

Table 14: List of parameters saved in POWER&ENERGY typical configuration

DEFAULT	
Description	Description
System type:	Not modified
Frequency:	Not modified
Clamp type:	Not modified
Full scale clamp:	Not modified
TV ratio:	Not modified
Start recording:	Not modified
Stop recording:	Not modified
Aggregation time:	Not modified
Voltage anomalies recording:	Selected
Reference voltage anomalies (Vn)	Not modified
High threshold limit for voltage anomalies:	Not modified
Low threshold limit for voltage anomalies:	Not modified
Harmonic recording	Selected
Selected voltage:	V1,V2,V3, V12,V32,V31
Voltage harmonics	THD%,DC,01,02... 49
Voltage unbalance:	Rev%
Voltage frequency::	Selected
Selected current	I1,I2,I3,In
Current harmonics:	THD%,DC,01,02... 49
Selected powers	Pt+, Pt-, Qti+, Qti-,Qtc+,Qtc-,St+,St-
Selected energies	Eat+,Eat-,Erti+,Erti-,Ertc+,Ertc-
Selected power factors, cosφ	Pfti+,Pfti-,Pftc+,Pftc-,dPfti+,dPfti-,dPftc+,dPftc-

Table 15: List of standard parameters saved in a DEFAULT typical configuration

Three-phase 3-wires 3 ϕ -Y Open, 3 ϕ -2EI. 1/2, 1 ϕ -CentralPoint – for USA systems

EN50160	
Description	Description
System type:	Not modified
Frequency:	Not modified
Clamp type:	Not modified
Full scale clamp:	Not modified
TV ratio:	Not modified
Start recording:	Not modified
Stop recording:	Not modified
Aggregation time:	10min
Harmonic recording:	Selected
Voltage anomalies recording:	Selected
Reference voltage anomalies (Vn)	Not modified
High threshold limit for voltage anomalies:	10%Vn
Low threshold limit for voltage anomalies:	10%Vn
Selected voltage:	V1,V2,V12
Voltage harmonics	THD%,DC,01,02... 49
Voltage unbalance:	Not selected
Voltage frequency::	Selected
Selected current	Not selected
Selected powers	Not selected

Table 16: List of standard parameters saved in a EN50160 typical configuration

HARM.	
Description	Description
System type:	Not modified
Frequency:	Not modified
Clamp type:	Not modified
Full scale clamp:	Not modified
TV ratio:	Not modified
Start recording:	Not modified
Stop recording:	Not modified
Aggregation time:	10min
Voltage anomalies recording:	Selected
Reference voltage anomalies (Vn)	Not modified
High threshold limit for voltage anomalies:	Not modified
Low threshold limit for voltage anomalies:	Not modified
Harmonic recording	Selected
Selected voltage:	V1,V2,V12
Voltage harmonics	THD%,DC,01,02... 49
Voltage unbalance:	Not selected
Voltage frequency::	Selected
Selected current	I1,I2,I _n
Current harmonics:	THD%,DC,01,02... 49
Powers, Energie, power factors	Not selected

Table 17: List of parameters saved in HARMONICS typical configuration

kWh (POWER & ENERGY)	
Description	Description
System type:	Not modified
Frequency:	Not modified
Clamp type:	Not modified
Full scale clamp:	Not modified
TV ratio:	Not modified
Start recording:	Not modified
Stop recording:	Not modified
Aggregation time:	15min
Voltage anomalies recording:	Selected
Reference voltage anomalies (Vn)	Not modified
High threshold limit for voltage anomalies:	Not modified
Low threshold limit for voltage anomalies:	Not modified
Harmonic recording	Not selected
Selected voltage:	V1,V2,V12
Voltage frequency:	Selected
Voltage unbalance:	Not selected
Selected current	I1,I2,I _n
Selected powers	Pt+, Pt-, Qti+, Qti-, Qtc+, Qtc-, St+, St- P1+, P1-, Q1i+, Q1i-, Q1c+, Q1c-, S1+, S1- P2+, P2-, Q2i+, Q2i-, Q2c+, Q2c-, S2+, S2-
Selected energies	Eat+, Eat-, Erti+, Erti-, Ertc+, Ertc- Ea1+, Ea1-, Er1i+, Er1i-, Er1c+, Er1c-, Es1+, Es1- Ea2+, Ea2-, Er2i+, Er2i-, Er2c+, Er2c-, Es2+, Es2-
Selected power factors, cosφ	Pfti+, Pfti-, Pftc+, Pftc-, dPfti+, dPfti-, dPftc+, dPftc- Pf1i+, Pf1i-, Pf1c+, Pf1c-, dPf1i+, dPf1i-, dPf1c+, dPf1c- Pf2i+, Pf2i-, Pf2c+, Pf2c-, dPf2i+, dPf2i-, dPf2c+, dPf2c-

Table 18: List of parameters saved in POWER&ENERGY typical configuration

DEFAULT	
Description	Description
System type:	Not modified
Frequency:	Not modified
Clamp type:	Not modified
Full scale clamp:	Not modified
TV ratio:	Not modified
Start recording:	Not modified
Stop recording:	Not modified
Aggregation time:	Not modified
Voltage anomalies recording:	Selected
Reference voltage anomalies (Vn)	Not modified
High threshold limit for voltage anomalies:	Not modified
Low threshold limit for voltage anomalies:	Not modified
Harmonic recording:	Selected
Selected voltage:	V1,V2,V12
Voltage harmonics:	THD%,DC,01,02... 49
Voltage unbalance:	Not selected
Voltage frequency:	Selected
Selected current	I1,I2,I _n
Current harmonics:	THD%,DC,01,02... 49
Selected powers	Pt+, Pt-, Qti+, Qti-, Qtc+, Qtc-, St+, St- P1+, P1-, Q1i+, Q1i-, Q1c+, Q1c-, S1+, S1- P2+, P2-, Q2i+, Q2i-, Q2c+, Q2c-, S2+, S2-
Selected energies	Eat+, Eat-, Erti+, Erti-, Ertc+, Ertc- Ea1+, Ea1-, Er1i+, Er1i-, Er1c+, Er1c-, Es1+, Es1- Ea2+, Ea2-, Er2i+, Er2i-, Er2c+, Er2c-, Es2+, Es2-
Selected power factors, cosφ	Pfti+, Pfti-, Pftc+, Pftc-, dPfti+, dPfti-, dPftc+, dPftc- Pf1i+, Pf1i-, Pf1c+, Pf1c-, dPf1i+, dPf1i-, dPf1c+, dPf1c- Pf2i+, Pf2i-, Pf2c+, Pf2c-, dPf2i+, dPf2i-, dPf2c+, dPf2c-

Table 19: List of standard parameters saved in a DEFAULT typical configuration

Three-phase 3-wire 3φ-ARON and 3φ-Δ Open (USA system)

EN50160	
Description	Description
System type:	Not modified
Frequency:	Not modified
Clamp type:	Not modified
Full scale clamp:	Not modified
TV ratio:	Not modified
Start recording:	Not modified
Stop recording:	Not modified
Aggregation time:	10min
Harmonic recording:	Selected
Voltage anomalies recording:	Selected
Reference voltage anomalies (Vn)	Not modified
High threshold limit for voltage anomalies:	10%Vn
Low threshold limit for voltage anomalies:	10%Vn
Selected voltage:	V12,V23,V31
Voltage harmonics:	THD%,DC,01,02... 49
Voltage unbalance:	Rev%
Voltage frequency:	Selected
Selected current	Not selected
Powers, Energie, power factors	Not selected

Table 20: List of standard parameters saved in a EN50160 typical configuration

HARM.	
Description	Description
System type:	Not modified
Frequency:	Not modified
Clamp type:	Not modified
Full scale clamp:	Not modified
TV ratio:	Not modified
Start recording:	Not modified
Stop recording:	Not modified
Aggregation time:	10min
Voltage anomalies recording:	Selected
Reference voltage anomalies (Vn)	Not modified
High threshold limit for voltage anomalies:	Not modified
Low threshold limit for voltage anomalies:	Not modified
Harmonic recording:	Selected
Selected voltage:	V12,V23,V31
Voltage harmonics:	THD%,DC,01,02... 49
Voltage unbalance:	Not selected
Voltage frequency:	Selected
Selected current	I1,I2,I3
Current harmonics:	THD%,DC,01,02... 49
Powers, Energie, power factors	Not selected

Table 21: List of parameters saved in HARMONICS typical configuration

kWh (POWER & ENERGY)	
Description	Description
System type:	Not modified
Frequency:	Not modified
Clamp type:	Not modified
Full scale clamp:	Not modified
TV ratio:	Not modified
Start recording:	Not modified
Stop recording:	Not modified
Aggregation time:	15min
Voltage anomalies recording:	Selected
Reference voltage anomalies (Vn)	Not modified
High threshold limit for voltage anomalies:	Not modified
Low threshold limit for voltage anomalies:	Not modified
Harmonic recording:	Not selected
Selected voltage:	V12,V23,V31
Voltage frequency:	Selected
Voltage unbalance:	Not selected
Selected current	I1,I2,I3
Selected powers	Pt+, Pt-, Qti+, Qti-, Qtc+, Qtc-, St+, St- P12+, P12-, Q12i+, Q12i-, Q12c+, Q12c-, S12+, S12- P32+, P32-, Q32i+, Q32i-, Q32c+, Q32c-, S32+, S32-
Selected energies	Eat+, Eat-, Ea12+, Ea12-, Ea32+, Ea32-, Erti+, Erti-, Ertc+, Ertc-, Er12i+, Er12i-, Er12c+, Er12c-, Er32i+, Er32i-, Er32c+, Er32c- Est+, Est-, Es12+, Es12-, Es32+, Es32-
Selected power factors, $\cos\phi$	Pfti+, Pfti-, Pftc+, Pftc-, Pf12i+, Pf12i-, Pf12c+, Pf12c-, Pf32i+, Pf32i- Pf32c+, Pf32c-, dPfti+, dPfti-, dPftc+, dPftc-, dPf12i+, dPf12i- dPf12c+, dPf12c-, dPf32i+, dPf32i-, dPf32c+, dPf32c-

Table 22: List of parameters saved in POWER&ENERGY typical configuration

DEFAULT	
Description	Description
System type:	Not modified
Frequency:	Not modified
Clamp type:	Not modified
Full scale clamp:	Not modified
TV ratio:	Not modified
Start recording:	Not modified
Stop recording:	Not modified
Aggregation time:	Not modified
Voltage anomalies recording:	Selected
Reference voltage anomalies (Vn)	Not modified
High threshold limit for voltage anomalies:	Not modified
Low threshold limit for voltage anomalies:	Not modified
Harmonic recording::	Selected
Tensione selezionata:	V12,V23,V31
Voltage harmonics:	THD%,DC,01,02... 49
Voltage unbalance:	Rev%
Voltage frequency:	Selected
Selected current	I1,I2,I3
Current harmonics:	THD%,DC,01,02... 49
Selected powers	Pt+, Pt-, Qti+, Qti-,Qtc+,Qtc-,St+,St- P12+, P12-, Q12i+, Q12i-, Q12c+, Q12c-, S12+, S12- P32+, P32-, Q32i+, Q32i-, Q32c+, Q32c-, S32+, S32-
Selected energies	Eat+,Eat-,Ea12+,Ea12-,Ea32+,Ea32-,Erti+,Erti-,Ertc+, Ertc-,Er12i+,Er12i-,Er12c+,Er12c-,Er32i+,Er32i-,Er32c+,Er32c- Est+,Est-,Es12+,Es12-,Es32+,Es32-
Selected power factors, cosφ	Pfti+,Pfti-,Pftc+,Pftc-,Pf12i+,Pf12i-,Pf12c+,Pf12c-,Pf32i+,Pf32i- Pf32c+,Pf32c-,dPfti+,dPfti-,dPftc+,dPftc-,dPf12i+,dPf12i- dPf12c+,dPf12c-,dPf32i+,dPf32i-,dPf32c+,dPf32c-

Table 23: List of standard parameters saved in a DEFAULT typical configuration



HT INSTRUMENTS SA
C/ Legalitat, 89
08024 Barcelona - ESP
Tel.: +34 93 408 17 77, Fax: +34 93 408 36 30
eMail: info@htinstruments.com
eMail: info@htinstruments.es
Web: www.htinstruments.es

HT ITALIA SRL
Via della Boaria, 40
48018 Faenza (RA) - ITA
Tel: +39 0546 621002
Fax: +39 0546 621144
eMail: ht@htitalia.it
Web: www.ht-instruments.com

HT INSTRUMENTS BRASIL
Rua Aguaçu, 171, bl. Ipê, sala 108
13098321 Campinas SP - BRA
Tel: +55 19 3367.8775
Fax: +55 19 9979.11325
eMail: vendas@ht-instruments.com.br
Web: www.ht-instruments.com.br

HT INSTRUMENTS USA LLC
3145 Bordentown Avenue W3
08859 Parlin - NJ - USA
Tel: +1 719 421 9323
eMail: sales@ht-instruments.us
Web: www.ht-instruments.com

HT INSTRUMENTS GMBH
Am Waldfriedhof 1b
D-41352 Korschenbroich - GER
Tel: +49 (0) 2161 564 581
Fax: + 49 (0) 2161 564 583
eMail: info@ht-instruments.de
Web: www.ht-instruments.de

HT ITALIA CHINA OFFICE
意大利 HT 中国办事处
Room 3208, 490# Tianhe road, Guangzhou - CHN
地址 : 广州市天河路 490 号壬丰大厦 3208 室
Tel.: +86 400-882-1983, Fax: +86 (0) 20-38023992
eMail: zenglx_73@hotmail.com
Web: www.guangzhouht.com