

**GMC 8364
version 3.0**



Data sheet

Application

The analysis unit GMC 8364 in combination with the series Gas monitor, Exmonitor and Exmess HC3 detectors has the following functions:

- measuring and displaying the current gas concentration at each measuring point
- monitoring and signalling an excessive gas concentration
- providing alarm outputs.

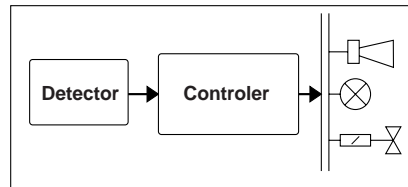

Structure

The GMC 8364 comprises the following components:

- detectors
- analysis system comprising:
 - GMC 8364
 - output card DIO-18 or an additional DIO-32 to connect the alarm relays
 - up to 4 sensor input cards AI-16 (16 sensors), or one card AI-8 (8 sensors)
 - power supply
- selectable devices e.g.:
 - ventilators
 - warning lights
 - warning signs
 - horns
 - solenoid valves

Product features

- TÜV-type approval in accordance with VDI 2053 „Ventilation equipment for garages and tunnels“
- up to 64 detectors can be connected
- GMC 8364: 16 freely programmable open collector outputs for connection to alarm relays. Optional extension to 48 outputs using a DIO-32 card
- programmable for various gases
- 3 alarm outputs per measuring channel
- alarm trigger through adjustable mean time values or instantaneous values
- alarm trigger when values exceed or fall below limits
- alarm trigger test without test gas
- simple operation through clear text readout in backlit alphanumeric display
- fault monitoring for:
 - sensor defects
 - computer defects
- automatic indication of service dates
- turning-off of particular measuring points



Mode of function

- **Inputs to GMC 8364**

Up to 64 detectors can be connected to one GMC. There are two types of cards that can be used here.

- AI-8: up to 8 detectors with 4 - 20 mA signal interface
- AI-16: up to 16 detectors with 4 - 20 mA signal interface

Up to 4 AI-16 cards, but no more than one AI-8 can be connected. Both cards provide 3 connections for every detector:

- supply voltage 21.7 - 27.8 VDC
- GND
- 4 - 20 mA input

Every detector is protected with a 100 mA fuse.

- **Outputs of GMC 8364**

All the outputs of the output cards are designed as open collectors. This means that in operation each output can directly drive the corresponding relay (24 V types) with the appropriate load. The outputs for computer defect and sensor fault are permanently defined, all the other outputs can be freely defined.

- GMC 8364 + DIO-18: 16 outputs freely programmable
- GMC 8364 + DIO-18 + DIO-32: 48 outputs freely programmable

The relays are assigned functions: fail-safe, saving, blinking (warning lights), drop out after 2 minutes (horn), resettable using reset button.

- **Controller - GMC 8364**

Mechanically, the controller is a panel with a housing. All the operating elements are at the front, together with a two-line backlit LCD display for programming and displaying measured values. LEDs indicate the current alarm status of all the measuring points.

- **Functions of GMC 8364**

The system differentiates between programming a measuring point and programming the detector mode. The maximum 64 measuring points can be assigned a total of 10 different detector modes. The following parameters are defined in detector mode: gas to be measured, measuring range, and three alarm thresholds. In addition it will ask here if the alarm should be triggered when either exceeding or falling below a level. A switching hysteresis can also be entered here. Moreover every threshold with an instantaneous value can be assigned a turn-on delay in the range of 0 -200 seconds. Thresholds with mean time values (only alarms 1-3) can be programmed in the range of 1- 60 minutes. Every measuring point must be assigned a sensor mode. The three alarm levels of every measuring point can be freely assigned an output (relay). The system will normally be operated in its basic configuration with three alarm levels. A fourth instantaneous threshold value can be assigned to the alarm level 3. This option can be used if alarm level 3 has been programmed as a mean time value threshold and should be assigned a further instantaneous triggering value. For test purposes, the alarms can be triggered in the whole unit without test gas. Individual measuring points can be excluded from this alarm test through the use of a password. The System data entry menu is similarly protected with a password. To ensure device security, the password can be changed at any time by the operator. If desired, the system can indicate the next service date.



Block diagram

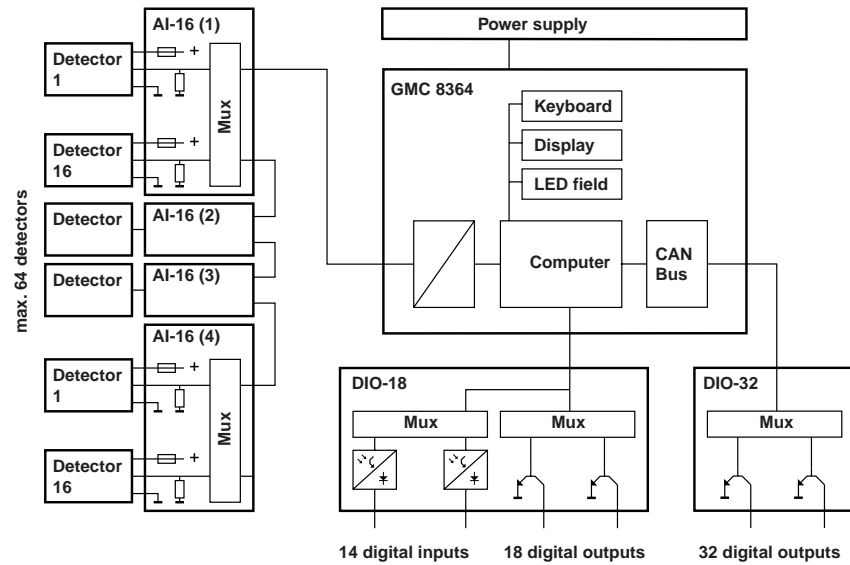

Technical specifications

- GMC 8364

Type	GMC 8364
Measuring channels	max. 64 (corresponds to 4 connected AI-16 modules) see technical specifications AI-16 / AI-8 module
Outputs	up to 16 / up to 48 see DIO-18 / DIO-32
Alarm levels	<ul style="list-style-type: none"> - 3+1 freely definable alarm levels per channel - alarm form: <ul style="list-style-type: none"> - freely definable mean time values 0 - 60 min. - alarm trigger with switch-on delay (0-200 sec.) - every alarm level can be defined as: <ul style="list-style-type: none"> - group alarm for several sensors - memorising / not memorising - alarm trigger when exceeding / falling below - switch-on delayed - blinking - resettable
Display elements	<ul style="list-style-type: none"> - two-line LCD display - LEDs for: <ul style="list-style-type: none"> - ready - error - programming - alarm 1 - alarm 2 - alarm 3 - horn
Display elements	4 keys for: <ul style="list-style-type: none"> - horn and alarm reset - guidance through menus - programming
Supply voltage	21.7 - 28 VDC, SELV
Current input	approx. 250 mA DC
Operating temp.	0 - +50°C
Storage temp.	-10 ... +50°C

Technical specifications

- **Detector input cards**
AI-8 / AI-16

Type	AI - 8	AI - 16
Measuring channels	up to 8	up to 16
Suitable detectors	Exmonitor, Gasmonitor, Exmess HC3	
Max distance to detectors	see sensor data sheets	
Detector interface	- input 4 - 20 mA, shunt 226 ohm to GND - sensor power supply 21.7 - 27.6 VDC, SELV - fuse 100 mA	
Operating voltage	21.7 - 27.6 VDC, SELV	
Current input	dependent on the number of used sensors. See sensor data sheet for current input of sensors	
Operating temperature	0 - +50°C	
Storage temperature	-10 - +50 °C	

- **Output card DIO-18**

Type	GMC 8364
Control inputs	external reset
Control voltage inputs	21.7 - 27.6 VDC, SELV
Control currents inputs	10 mA DC per used control input
Control outputs (Open collector)	- hardware fault - software fault 16 outputs freely available
Max. load at outputs	up to 27.6 VDC, max. 50 mADC
Operating voltage	21.7 - 27.6 VDC, SELV
Current input	no. of used control inputs x 10mA plus the current input per relays
Operating temperature	0 - +50°C
Storage temperature	-10 - +50°C

- **Output card DIO-32**

Type	DIO-32
Control outputs (Open collector)	32 freely programmable
Max. load at outputs	up to 27.6 VDC, max. 50 mADC
Operating voltage	21.7 - 27.6 VDC, SELV
Current input	60 mADC plus current input per relay
Operating temperature	0 - +50°C
Storage temperature	-10 - +50°C



Mechanical specifications

● **GMC 8364**

Design	panel housing
Weight	approx. 500 g
Dimensions (H x W x D)	72 x 144 x 148 mm
Mounting cut-out (H x W)	68 x 138 mm
Terminals	1.5 mm ²
Enclosure material	flame-resistant Noryl
Protection class	IP 30

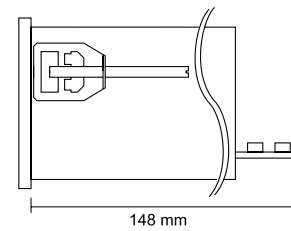
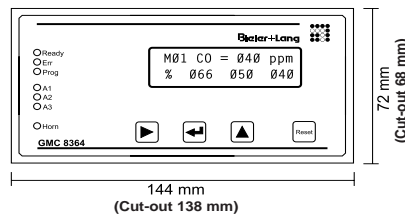

● **Sensor input cards**
AI-8 / AI-16

Type	AI - 8	AI - 16
Design	suitable for mounting rails	
Dimensions (H x W x D)	70 x 156 x 76 mm	
Weight	approx. 150 g	approx. 200g
Terminals	1.5 mm ²	

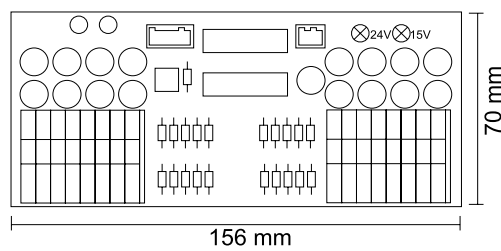



Mechanical specifications

● **Output card DIO-18**

Weight	approx. 180 g
Design	suitable for mounting rails
Dimensions (H x W x D)	70 x 156 x 76 mm
Terminals	1.5 mm ²

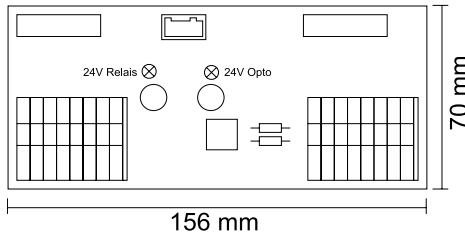

● **Output card DIO-32**

Weight	approx. 230 g
Design	suitable for mounting rails
Dimensions (H x W x D)	70 x 156 x 76 mm
Terminals	1.5 mm ²

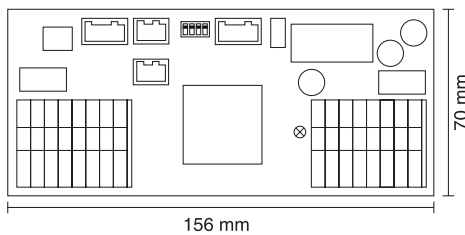

Approval

Type approval certificate in accordance with VDI 2053 (Ventilation equipment for garages und tunnels) in combination with the sensor Gasmonitor CO-500. Inspection no. 432-987996, TÜV Rheinland.

Safety

The following standards guarantee ultimate appliance safety:

- EN 50081-1 01/1992 EMC - emitted interference
- EN 50082-2 02/1995 EMC - interference immunity
- EN 61010-1 03/1994 low voltage guideline
- EN 60439-1 04/1994 low voltage guideline

Equipment

- horns
- warning lights
- warning signs
- warning signs with integrated emergency power supply
- solenoid valves
- power supply
- central emergency power supply unit comprising:
 - battery charger
 - battery packs with appropriate capacity
- test gas kit

**Service**

Everything from one source - from project development to the installation of your new gas alarm unit. Guaranteed by our comprehensive sales and service network. Call us for the address of your local contact partner. Our after-sales technicians will be pleased to assist you with hands-on help and advice.

Custom-made equipment

Our sales and service engineers will help you with your measurement and control problems. A wide range of units, appliances, enclosures and equipment, and many years of experience in the field allow us to develop and construct a measuring system for your very special requirements.



Bieler + Lang GmbH
Gasmess- und Warnsysteme

Postfach 1129, 77842 Achern
Von-Drais-Straße 31, 77855 Achern

Telefon (0 78 41) 69 37 - 0
Telefax (0 78 41) 69 37 - 99
e-Mail info@bieler-lang.de

Internet: www.bieler-lang.de

Les services d'EURO-INDEX

EURO-INDEX fournit des services pour tous les instruments de sa gamme de fournitures et offre des services, de la connaissance et du personnel hautement qualifié pour l'entretien (préventif), la réparation et le calibrage de vos instruments de mesure.

Centre de Service Agréé.....

EURO-INDEX est un Centre de Service Agréé pour toutes les marques représentées.

Autrement dit, vos instruments sont traités par du personnel formé et compétent, qui dispose des outils et logiciels adéquats. Seules des pièces d'origine sont utilisées et la garantie de votre instrument ainsi que la certification (ATEX, EN50379, etc.) restent valables.

Laboratoire de maintenance et de calibrage

EURO-INDEX dispose d'un laboratoire de maintenance et de calibrage particulièrement moderne, titulaire d'une accréditation conforme à la norme NEN-EN-ISO/IEC 17025. Cette accréditation est valable pour différentes grandeurs, telles que spécifiées dans le champ d'application associé au numéro d'accréditation K105.



MQS®

MQS est une formule d'entretien exclusive comportant un entretien et un calibrage périodiques de vos instruments de mesure. La prise en charge de multiples aspects vise à vous libérer de tout souci lors de l'utilisation de vos instruments de mesure. Les coûts sont modiques et prévisibles.

Accès numérique à vos certificats de calibrage avec Mon MQS

Mon MQS est un portail Web qui vous donne accès partout et à tout moment à vos certificats de calibrage et aux documents apparentés.

Location d'instruments de mesure

- Vaste assortiment
- Conseils avisés
- Les instruments sont livrés avec leurs accessoires et leurs certificats de calibrage traçables

EURO-INDEX Academy

- Formations sur les produits (individuelles et collectives)
- Séminaires
- Vidéos de démonstration et d'instruction

Visionnez la vidéo sur notre chaîne YouTube et découvrez tout ce qu'il vous faut savoir sur MQS



Guichet des services



Calibrage de l'analyse de gaz de combustion



Séminaires et ateliers



Calibrage de la thermographie

Sous réserve de modifications EURO-INDEX® FR 18001

Le nom et la marque Bluetooth® sont la propriété de Bluetooth SIG Inc. L'utilisation de ce nom par EURO-INDEX s'effectue sous licence.



BELGIQUE
Leuvensesteenweg 607
1930 Zaventem
T: 02 - 757 92 44
F: 02 - 757 92 64
info@euro-index.be
www.euro-index.be

PAYS-BAS
Rivium 2e straat 12
2909 LG Capelle a/d IJssel
T: +31 - (0)10 - 2 888 000
F: +31 - (0)10 - 2 888 010
verkoop@euro-index.nl
www.euro-index.nl

